



US00D920715S

(12) **United States Design Patent**
Terndrup et al.

(10) **Patent No.:** **US D920,715 S**

(45) **Date of Patent:** **** Jun. 1, 2021**

(54) **FOLDABLE SEATING CUSHION**
(71) Applicants: **Joseph Terndrup**, Burleson, TX (US);
Joshua Terndrup, Burleson, TX (US)
(72) Inventors: **Joseph Terndrup**, Burleson, TX (US);
Joshua Terndrup, Burleson, TX (US)
(**) Term: **15 Years**

| | | | |
|-------------------|---------|----------------|-------------------------|
| D805,323 S * | 12/2017 | Chan | D6/601 |
| D843,133 S * | 3/2019 | Cohen | D6/601 |
| D848,180 S * | 5/2019 | Huang | D6/601 |
| D854,353 S * | 7/2019 | Xiang | D6/596 |
| D863,822 S * | 10/2019 | Chen | D6/601 |
| D886,494 S * | 6/2020 | Liu | D6/601 |
| D896,551 S * | 9/2020 | Terndrup | D6/601 |
| D898,425 S * | 10/2020 | Yang | D6/601 |
| D907,400 S * | 1/2021 | Federl | D6/601 |
| 2015/0108802 A1 * | 4/2015 | Krishtul | A47C 7/029 297/283.1 |

(21) Appl. No.: **29/728,351**
(22) Filed: **Mar. 18, 2020**
(51) **LOC (13) Cl.** **06-09**
(52) **U.S. Cl.**
USPC **D6/601**
(58) **Field of Classification Search**
USPC D6/595-601, 604, 606; D24/183, 190;
D21/803, 809
CPC A47C 20/00; A47C 20/021; A47C 7/742;
A47C 7/021; A47D 15/001; A47D
15/008; A47G 9/00; A47G 9/10; B62J
1/26
See application file for complete search history.

* cited by examiner

Primary Examiner — Jennifer L Rempfer

(57) **CLAIM**

The ornamental design for foldable seating cushion, as shown and described.

DESCRIPTION

FIG. 1 is a top view of the foldable seating cushion, showing my new design in unfolded position;
FIG. 2 is a bottom view thereof in unfolded position;
FIG. 3 is a left side view thereof in unfolded position;
FIG. 4 is a right side view thereof in unfolded position;
FIG. 5 is a front view thereof in unfolded position;
FIG. 6 is a back view thereof in unfolded position;
FIG. 7 is an isometric view thereof in unfolded position;
FIG. 8 is an isometric view thereof in semi-folded position;
and,
FIG. 9 is an isometric view thereof in folded position.

(56) **References Cited**
U.S. PATENT DOCUMENTS
4,925,064 A * 5/1990 Comora A45F 3/04
224/155
6,839,928 B1 * 1/2005 Woodall A47C 4/52
5/653
D731,816 S * 6/2015 Edgemon D6/601
9,051,169 B2 * 6/2015 Pearce B68G 7/00

1 Claim, 9 Drawing Sheets

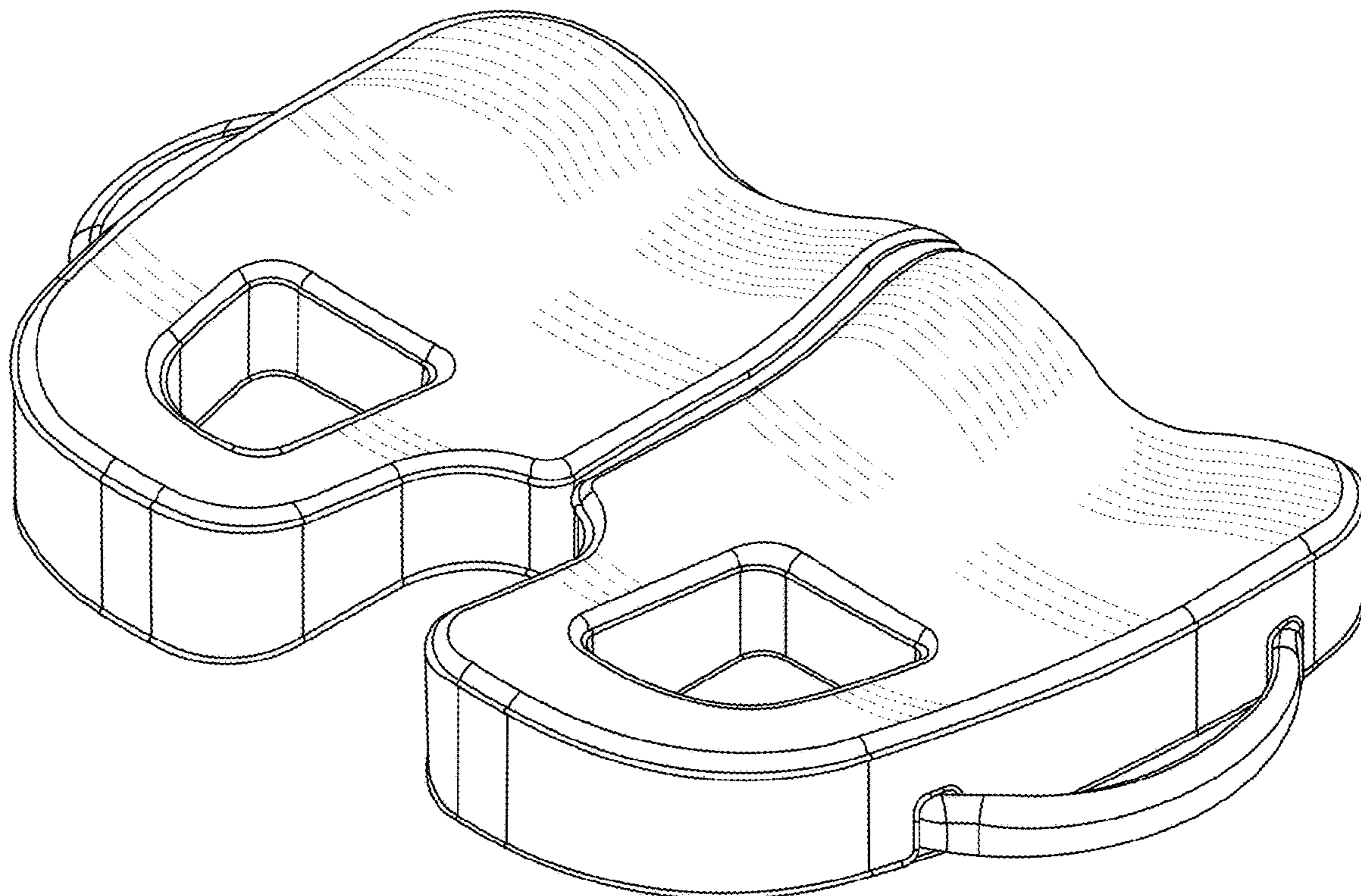

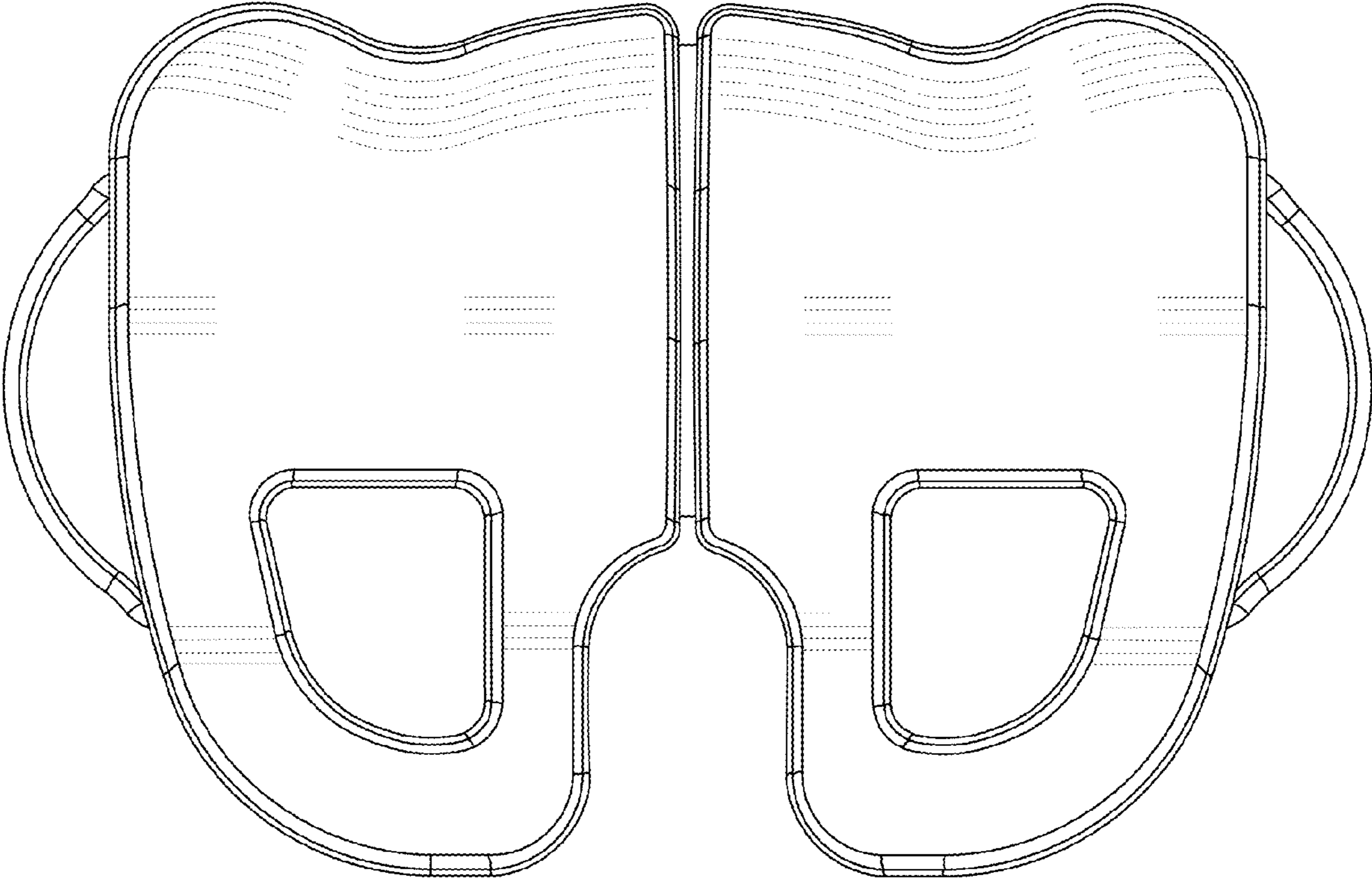

FIG. 1

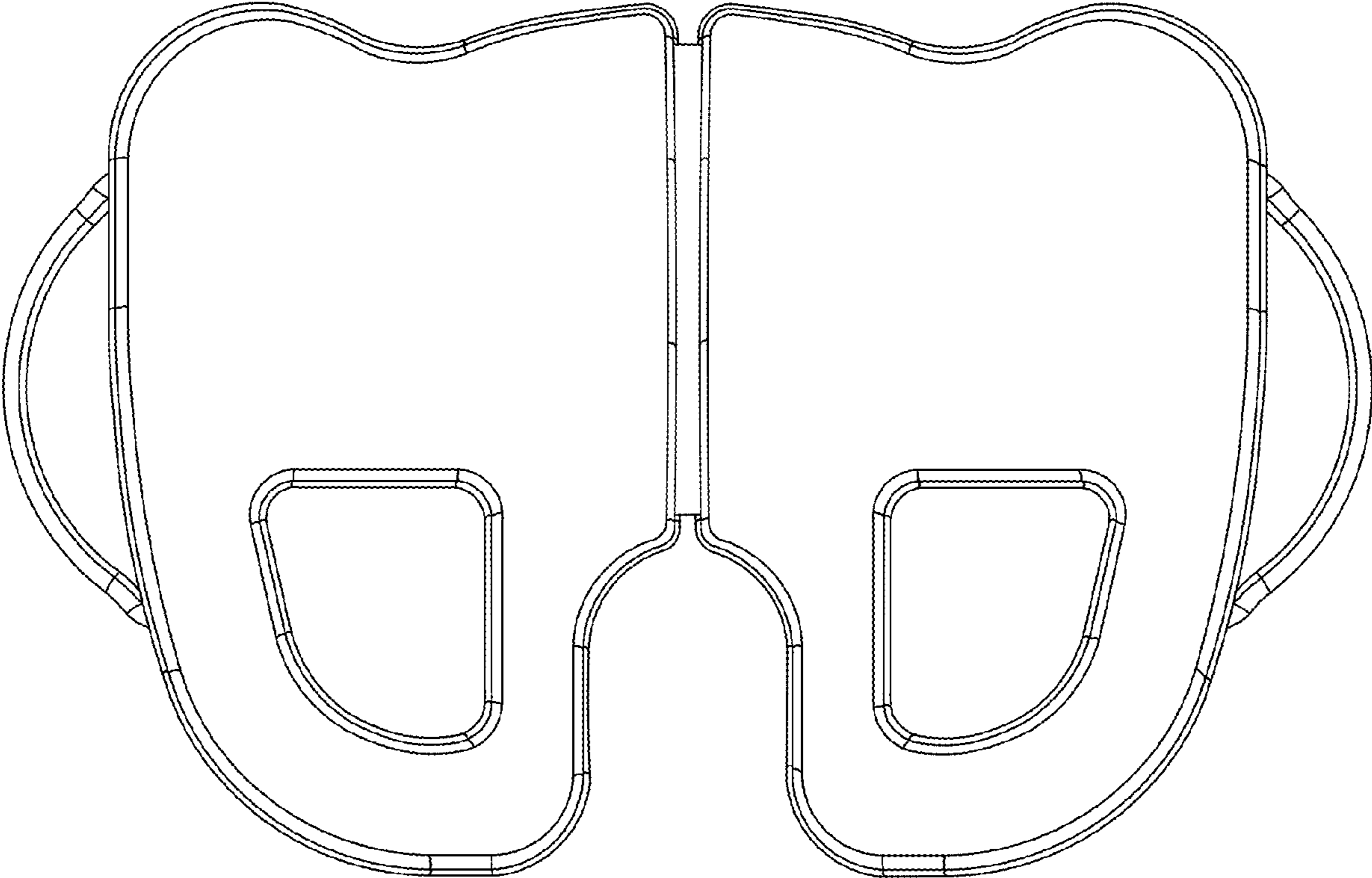

FIG. 2

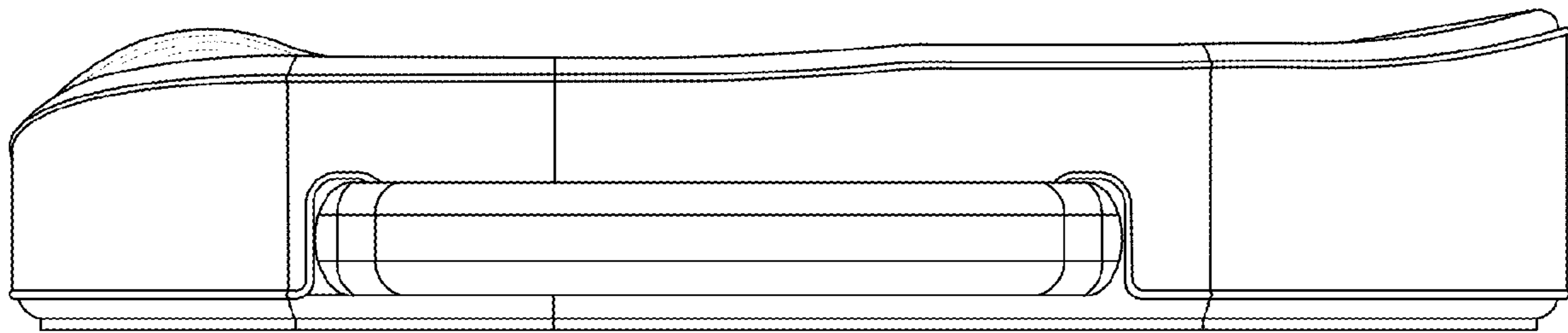

FIG. 3

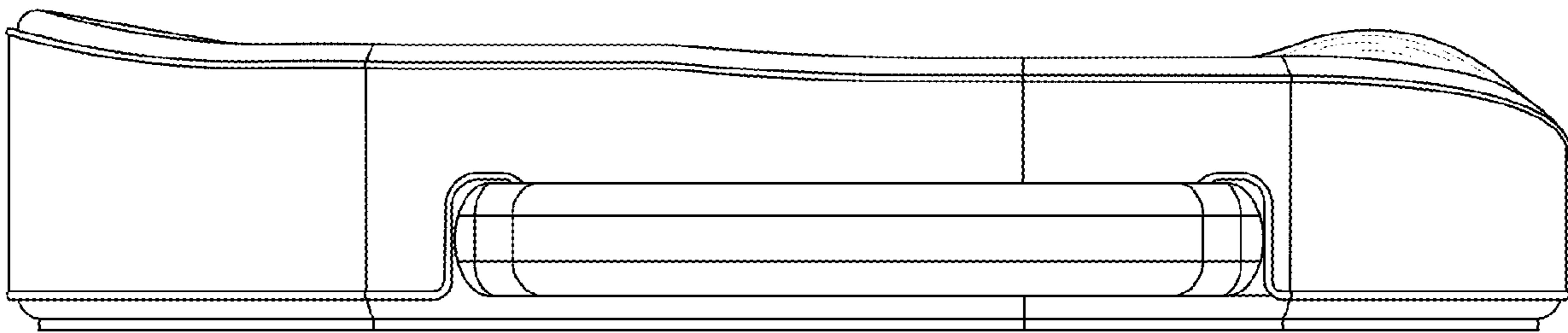

FIG. 4

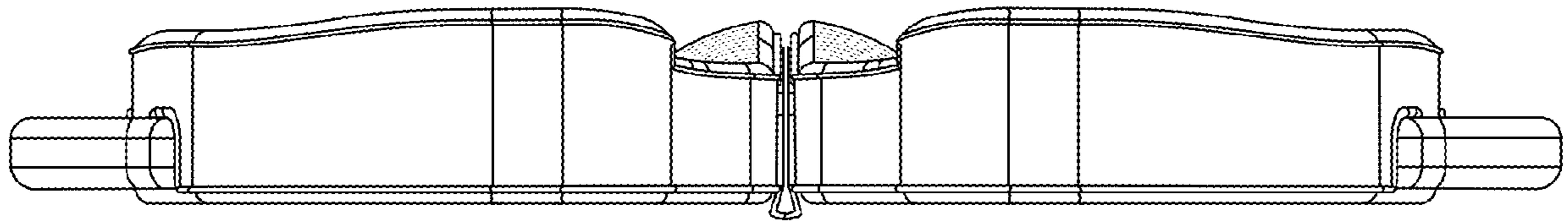

FIG. 5

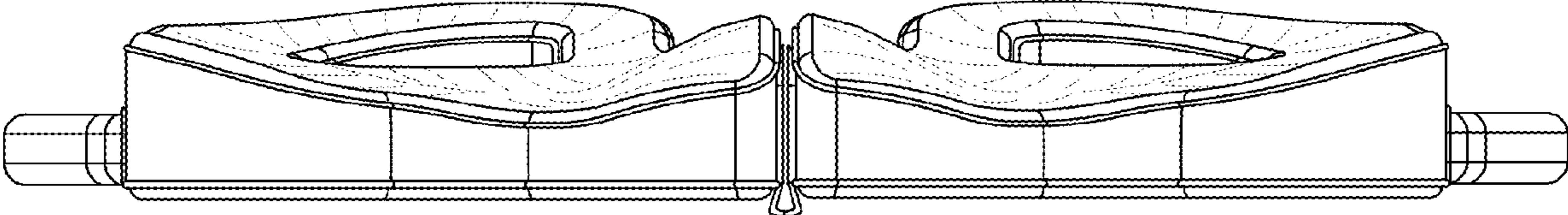

FIG. 6

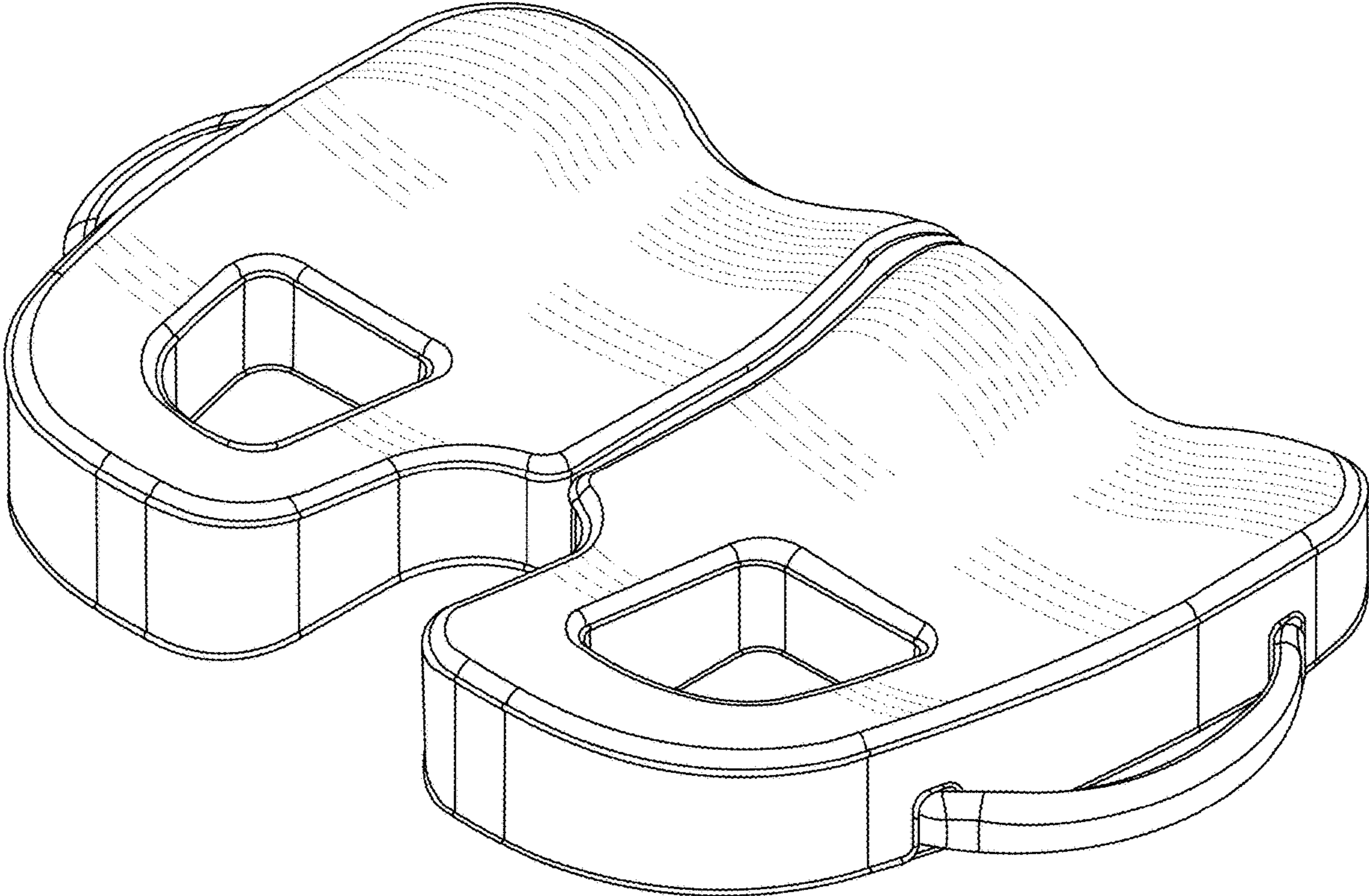

FIG. 7

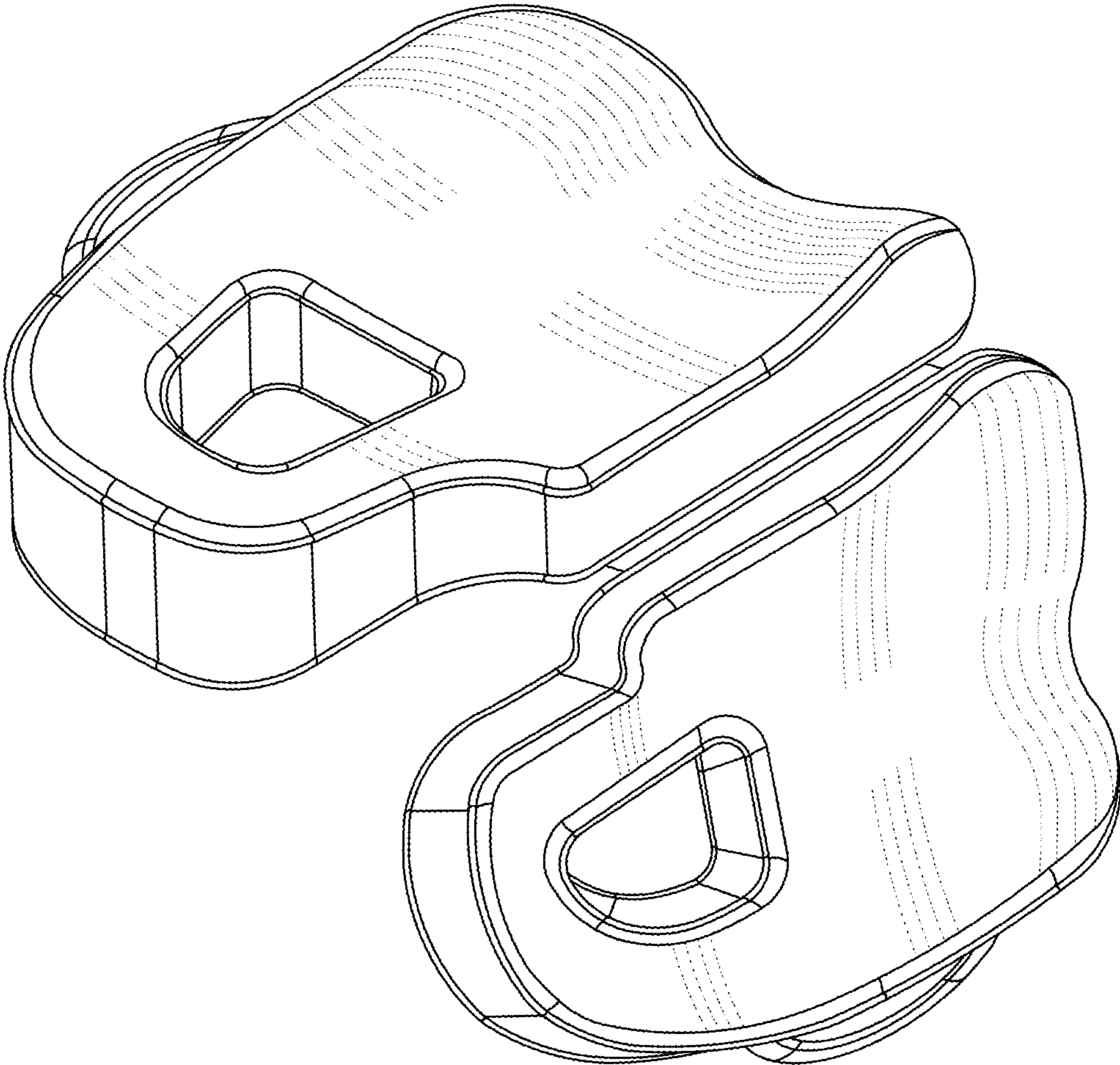

FIG. 8

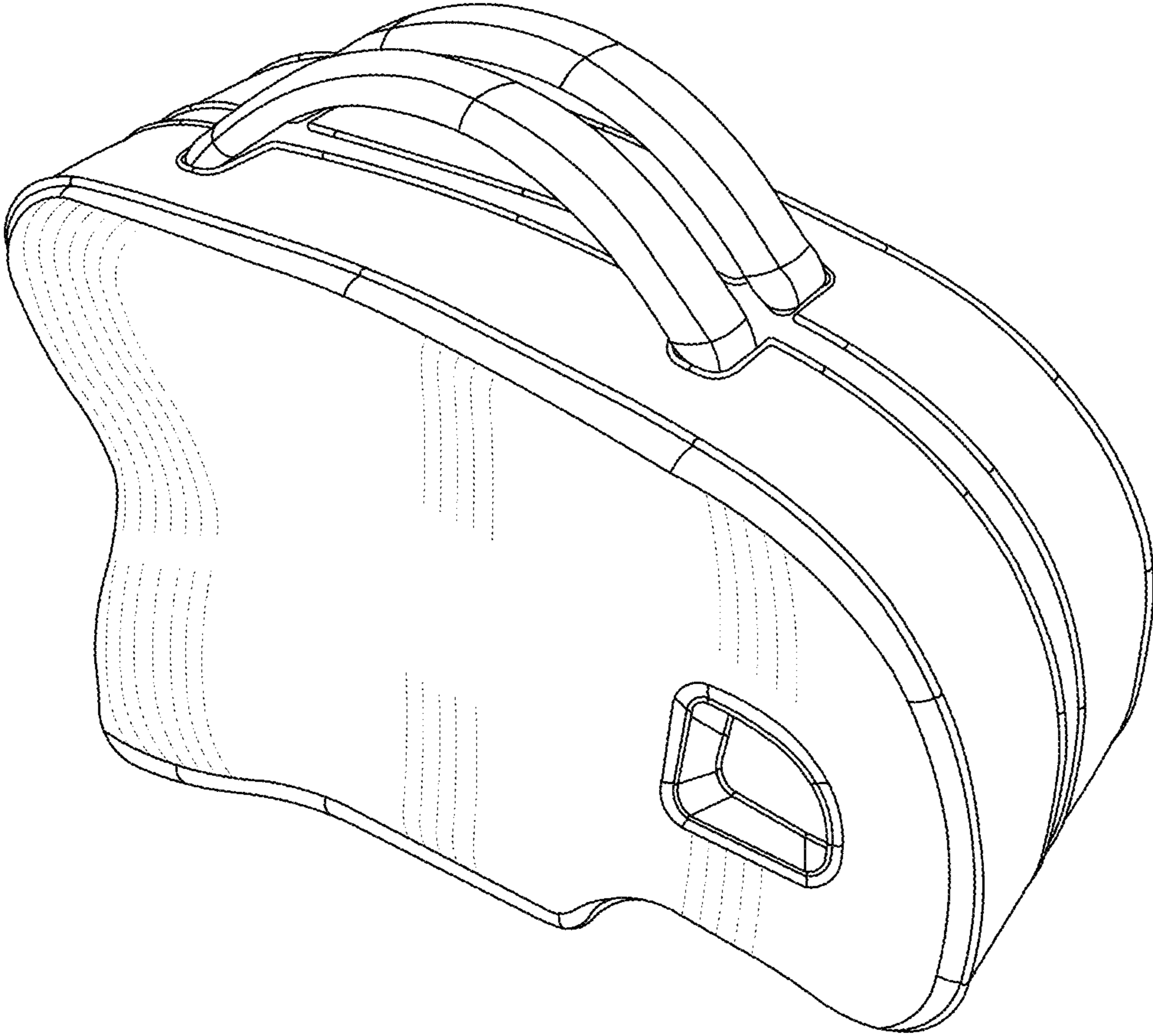

FIG. 9