



US00D920692S

(12) **United States Design Patent**
Li

(10) **Patent No.:** **US D920,692 S**

(45) **Date of Patent:** **** Jun. 1, 2021**

(54) **CHAIR**

(71) Applicant: **39F USA INC**, Rancho Cucamonga, CA (US)

(72) Inventor: **Yuehai Li**, Rancho Cucamonga, CA (US)

(**) Term: **15 Years**

(21) Appl. No.: **29/711,782**

(22) Filed: **Nov. 2, 2019**

(51) **LOC (13) Cl.** **06-01**

(52) **U.S. Cl.**
USPC **D6/360**

(58) **Field of Classification Search**
USPC D6/334, 349, 360, 361, 364, 365, 366, D6/367, 375, 378, 379, 380
CPC .. A47C 3/00; A47C 3/18; A47C 3/185; A47C 3/20; A47C 1/00; A47C 1/02; A47C 1/022; A47C 1/037; A47C 7/24; A47C 7/36; A47C 7/46; A47C 7/18; A47C 7/50; A47C 13/005; A47C 15/002; A47C 17/02; A47C 9/007

See application file for complete search history.

(56) **References Cited**

U.S. PATENT DOCUMENTS

D232,879 S * 9/1974 Samhammer D6/360
3,841,704 A * 10/1974 Platner A47C 3/12
297/452.55

D800,466 S *	10/2017	Ono	D6/360
D885,073 S *	5/2020	Wang	D6/374
D893,911 S *	8/2020	Gori	D6/374
D893,912 S *	8/2020	Wang	D6/375
D899,121 S *	10/2020	Yang	D6/360
D905,990 S *	12/2020	Li	D6/366
D906,700 S *	1/2021	Li	D6/334
D907,933 S *	1/2021	Li	D6/334
D911,729 S *	3/2021	Kubryk	D6/366

* cited by examiner

Primary Examiner — R. Johnson

(74) *Attorney, Agent, or Firm* — Feng Qian

(57) **CLAIM**

The ornamental design for a chair, as shown and described.

DESCRIPTION

FIG. 1 is a front perspective view of a chair showing my new design;

FIG. 2 is a front elevation view thereof;

FIG. 3 is a rear elevation view thereof;

FIG. 4 is a left-side elevation view thereof;

FIG. 5 is a right-side elevation view thereof;

FIG. 6 is a top plan view thereof; and,

FIG. 7 is a bottom plan view thereof.

1 Claim, 7 Drawing Sheets

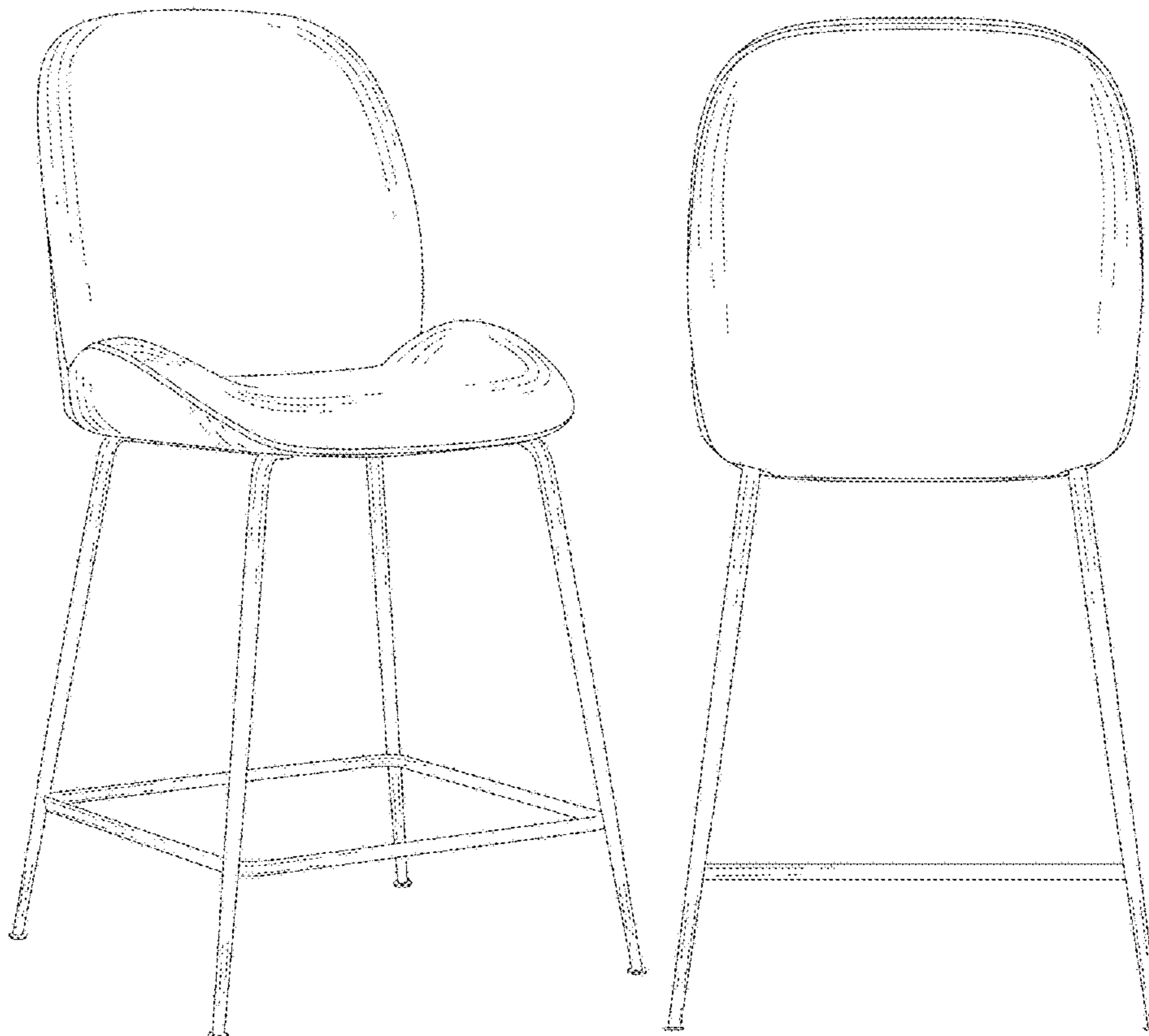

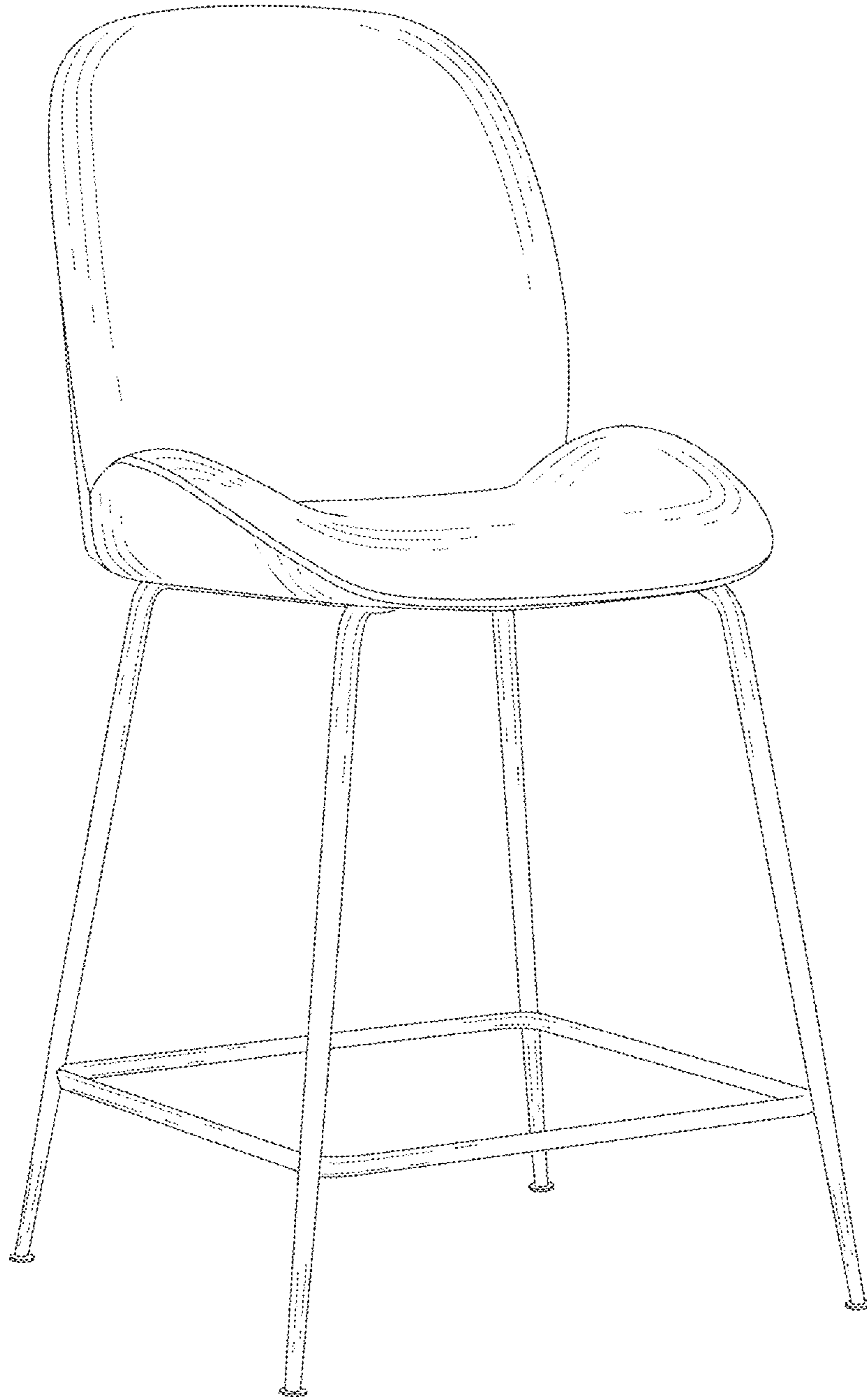

Fig.1

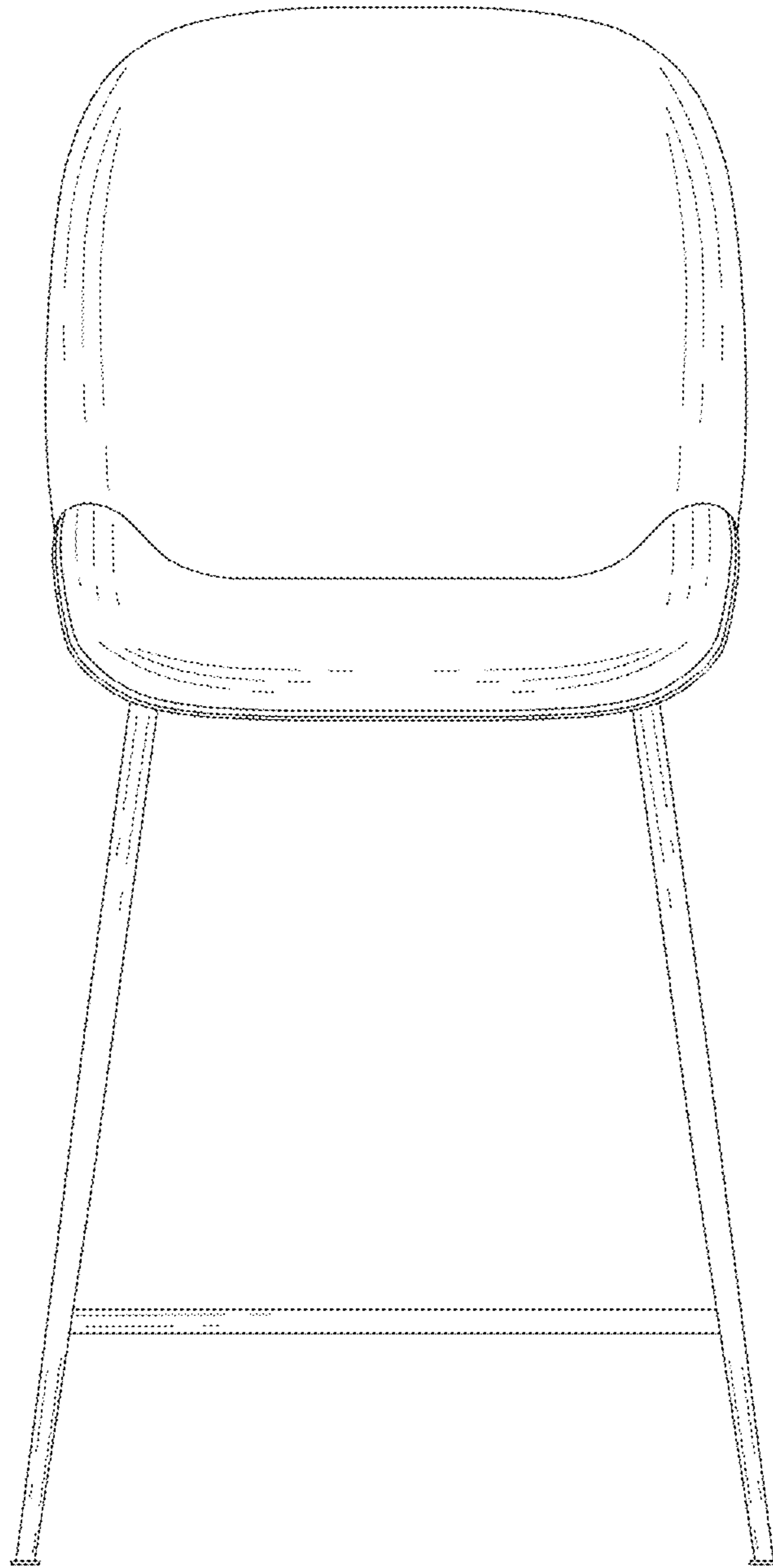

Fig.2

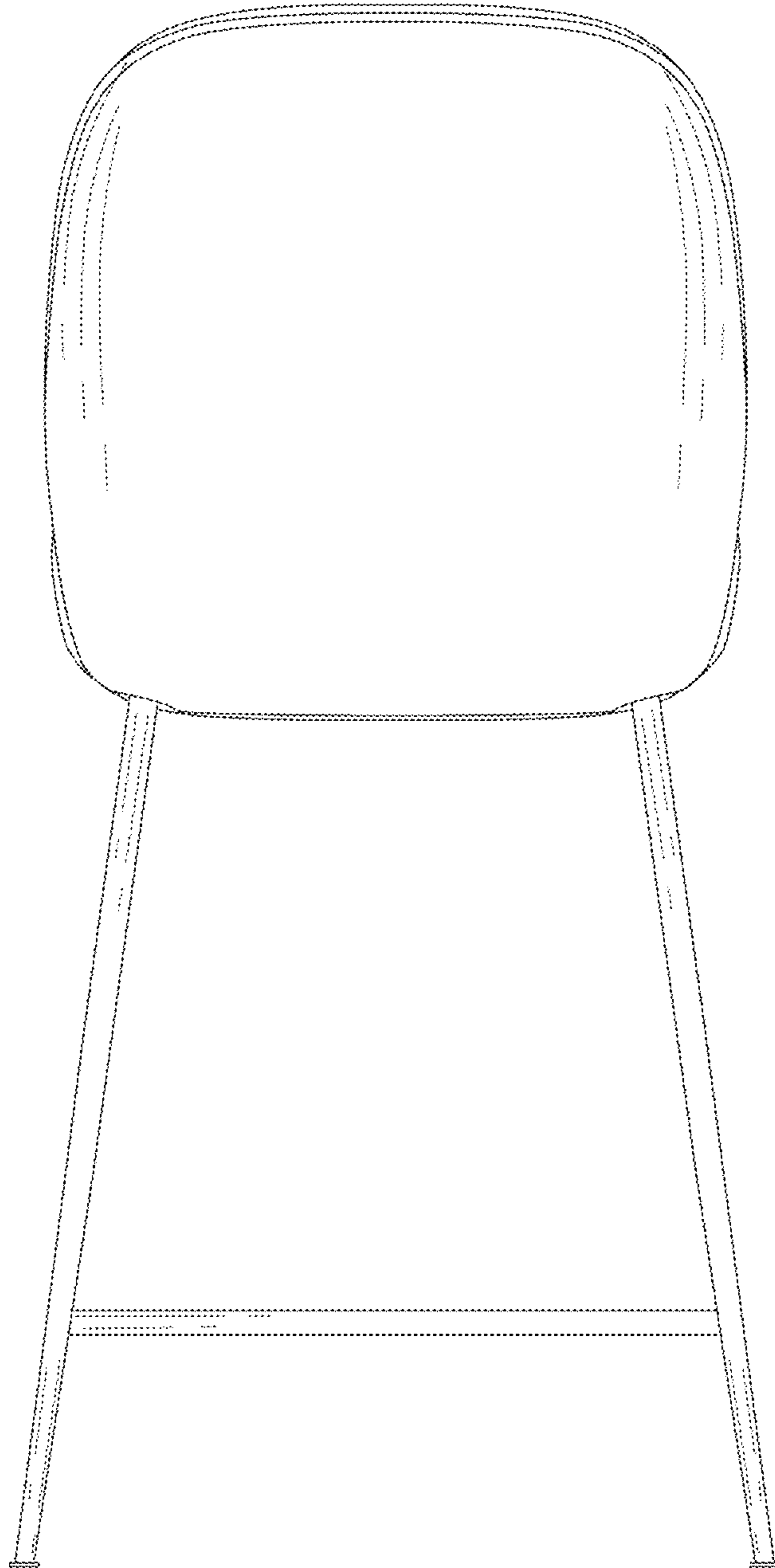

Fig.3

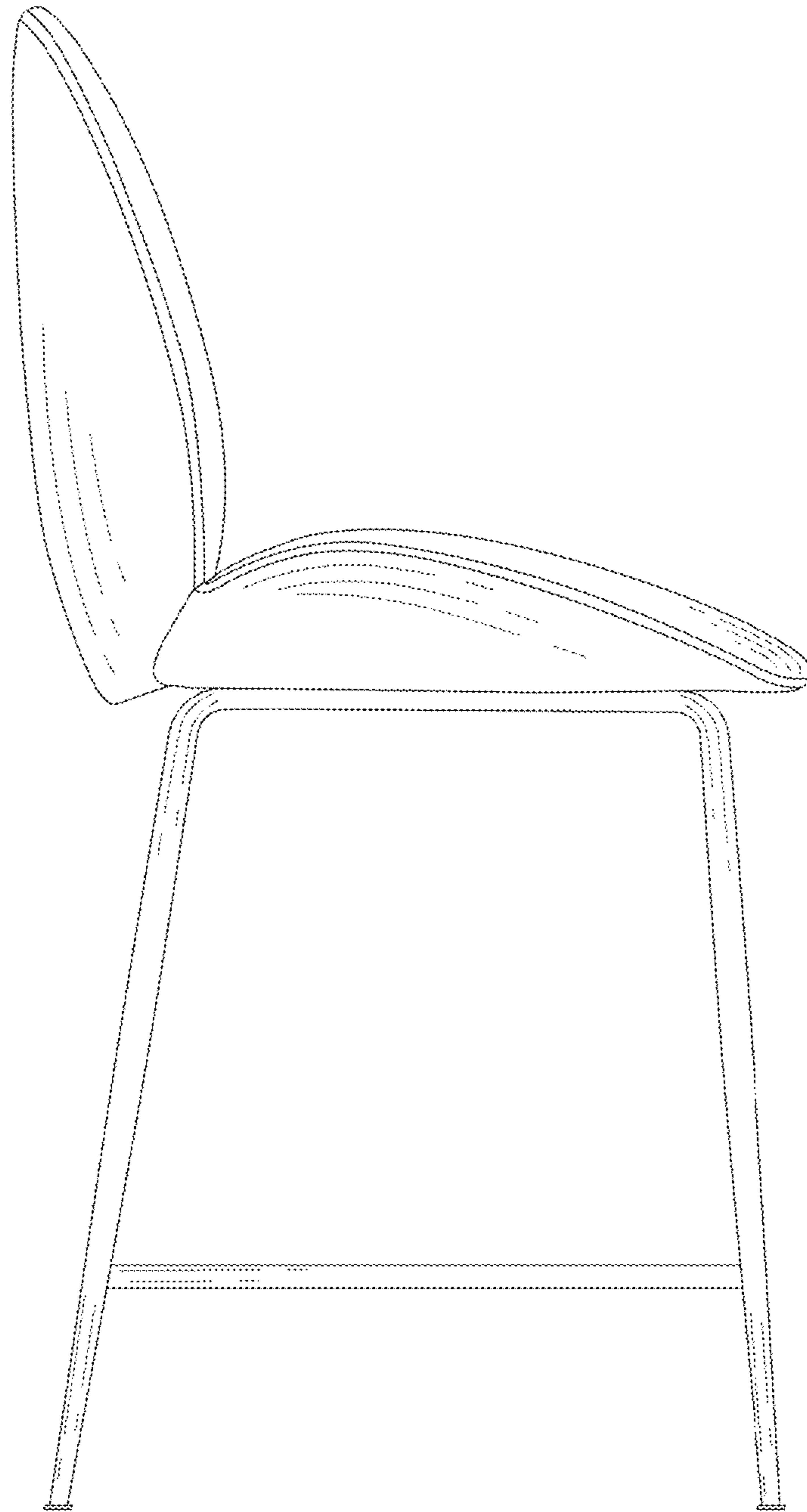

Fig.4

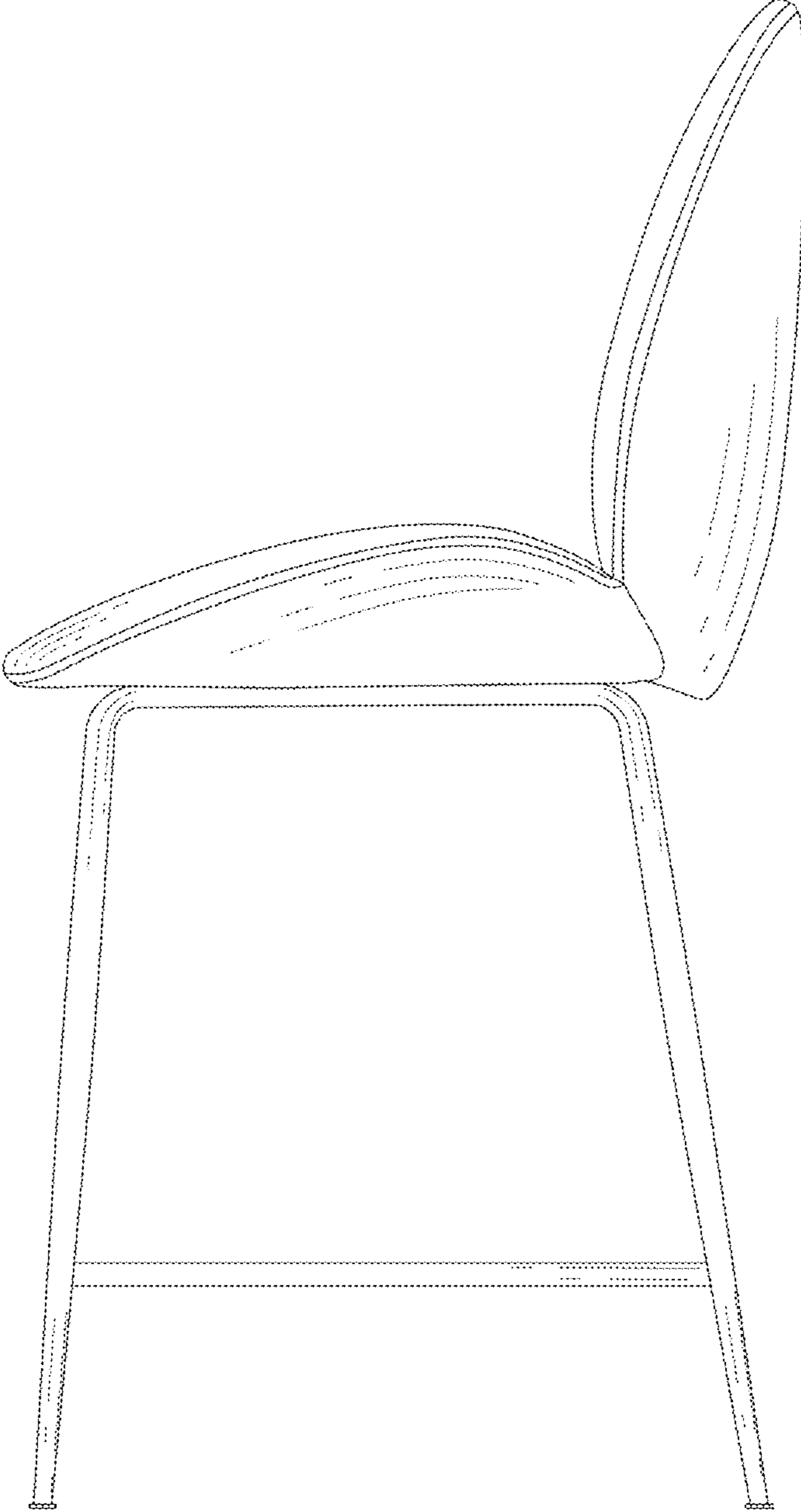

Fig.5

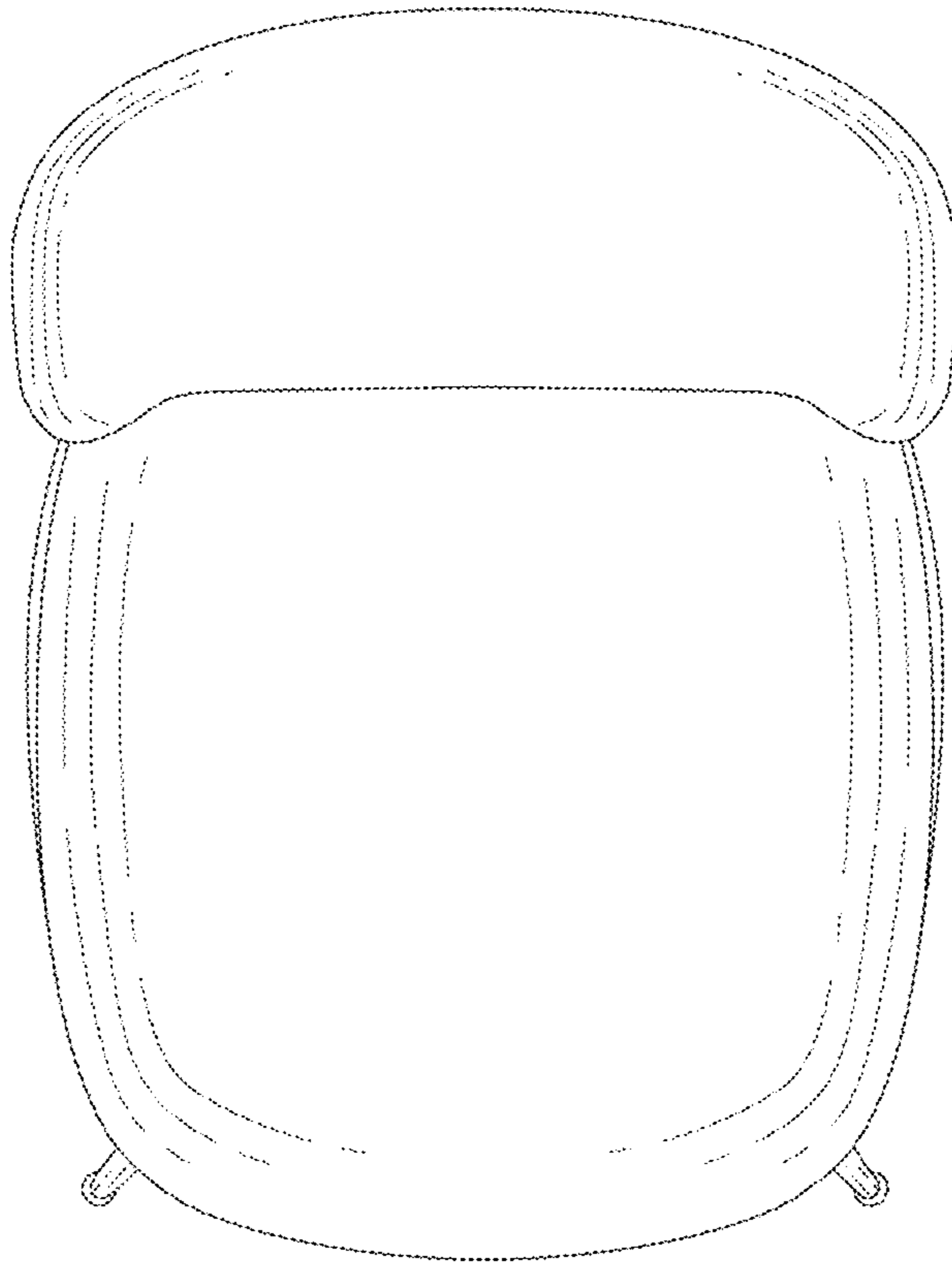

Fig.6

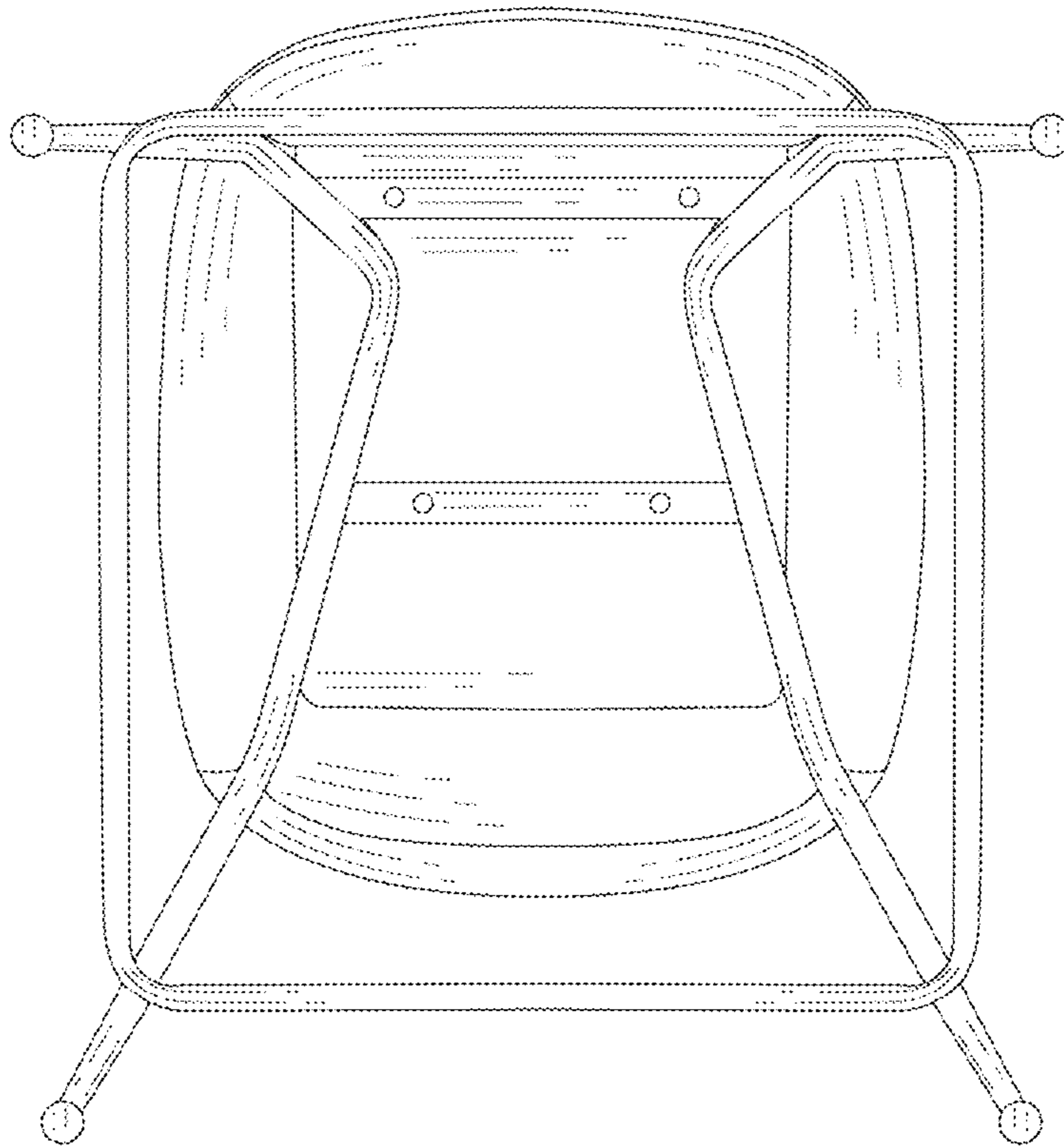

Fig.7