



US00D920634S

(12) **United States Design Patent**
Horsey

(10) **Patent No.:** **US D920,634 S**
(45) **Date of Patent:** **** Jun. 1, 2021**

(54) **BACK ACCESSIBLE GARMENT**

(71) Applicant: **Michele B. Horsey**, Little Rock, AR
(US)

(72) Inventor: **Michele B. Horsey**, Little Rock, AR
(US)

(**) Term: **15 Years**

(21) Appl. No.: **29/608,494**

(22) Filed: **Jun. 22, 2017**

(51) **LOC (13) Cl.** **02-02**

(52) **U.S. Cl.**
USPC **D2/860**

(58) **Field of Classification Search**
USPC D2/860, 742-744; 2/46, 79
CPC A41D 13/02; A41D 13/0512
See application file for complete search history.

(56) **References Cited**

U.S. PATENT DOCUMENTS

D291,640 S *	9/1987	Russo	D2/743
D298,380 S *	11/1988	Clutts, Sr.	D2/743
D461,624 S *	8/2002	Foster	D2/743
D505,535 S *	5/2005	Kern	D2/742
D538,008 S *	3/2007	Helbing	D2/743
D550,428 S *	9/2007	Kern	D2/742
D593,281 S *	6/2009	Pitchforth	D2/743
D598,181 S *	8/2009	Rowe	D2/743
D654,662 S *	2/2012	Lewis	D2/743
8,250,675 B2 *	8/2012	Duncan	A41D 1/086 2/227

D690,085 S *	9/2013	Grosbol	D2/743
2013/0152263 A1 *	6/2013	Hare	A41D 13/012 2/46
2018/0295904 A1 *	10/2018	Looper	A41D 13/02

* cited by examiner

Primary Examiner — Kevin K Rudzinski

Assistant Examiner — J. Thorn, Sr.

(74) *Attorney, Agent, or Firm* — Joe D. Calhoun

(57) **CLAIM**

I claim the ornamental design for a back accessible garment, as shown and described.

DESCRIPTION

FIG. 1 is a back perspective view of a back accessible garment, with the back access in the closed position.
 FIG. 2 is a right side elevation view thereof.
 FIG. 3 is a back side elevation view thereof.
 FIG. 4 is a front side elevation view thereof.
 FIG. 5 is a back side elevation view thereof, in a partially open configuration.
 FIG. 6 is a close-up view of the material encircled in FIG. 5, after the zipper is in a fully open configuration.
 FIG. 7 is a front side elevation view, in a fully open configuration.
 FIG. 8 is a right side elevation view thereof; and,
 FIG. 9 is a right side elevation view, in a squatting configuration.
 The broken lines form no part of the claimed design. The human arms, feet, head and undershirt depict environment and form no part of the claimed design.

1 Claim, 9 Drawing Sheets

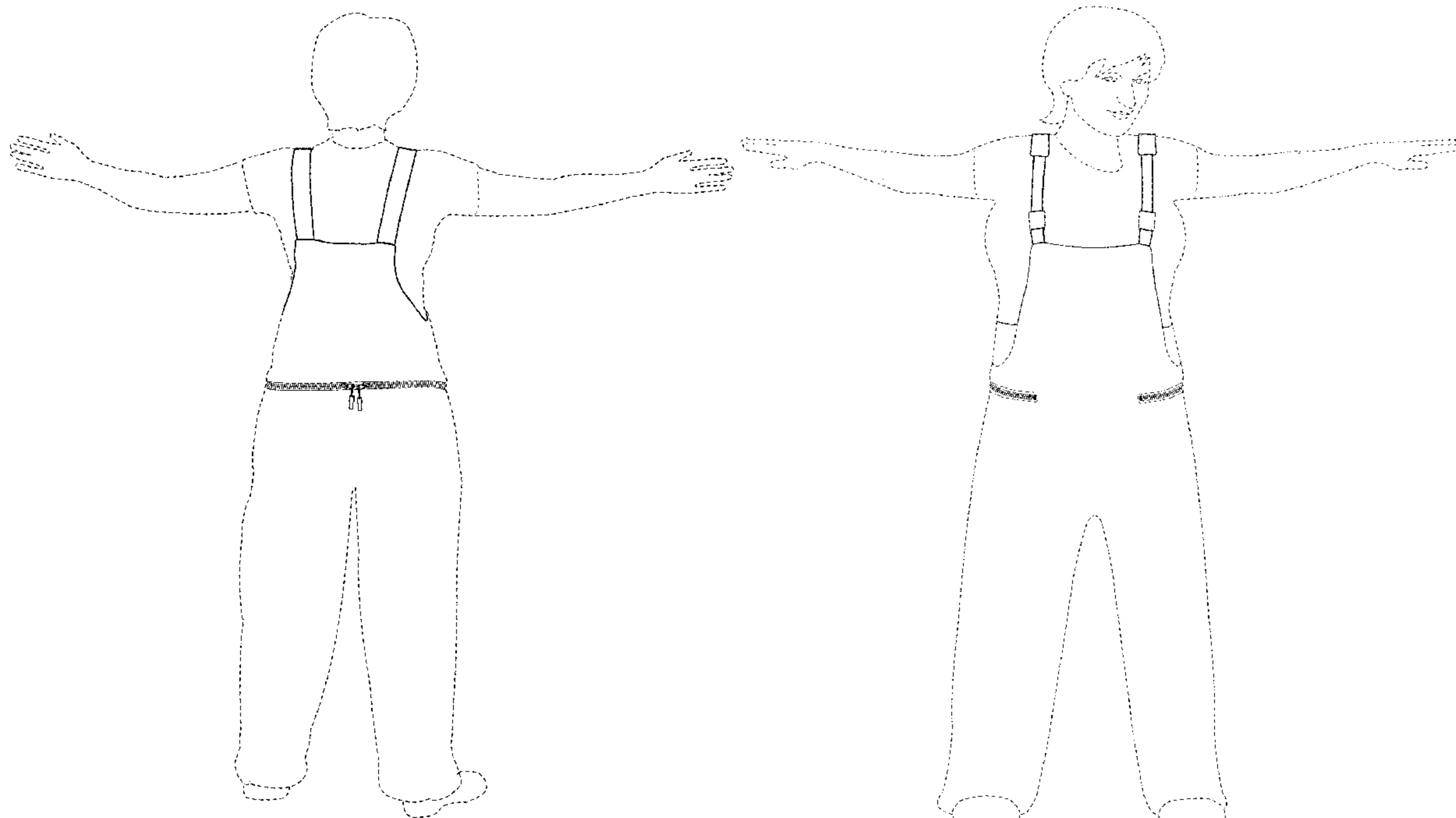

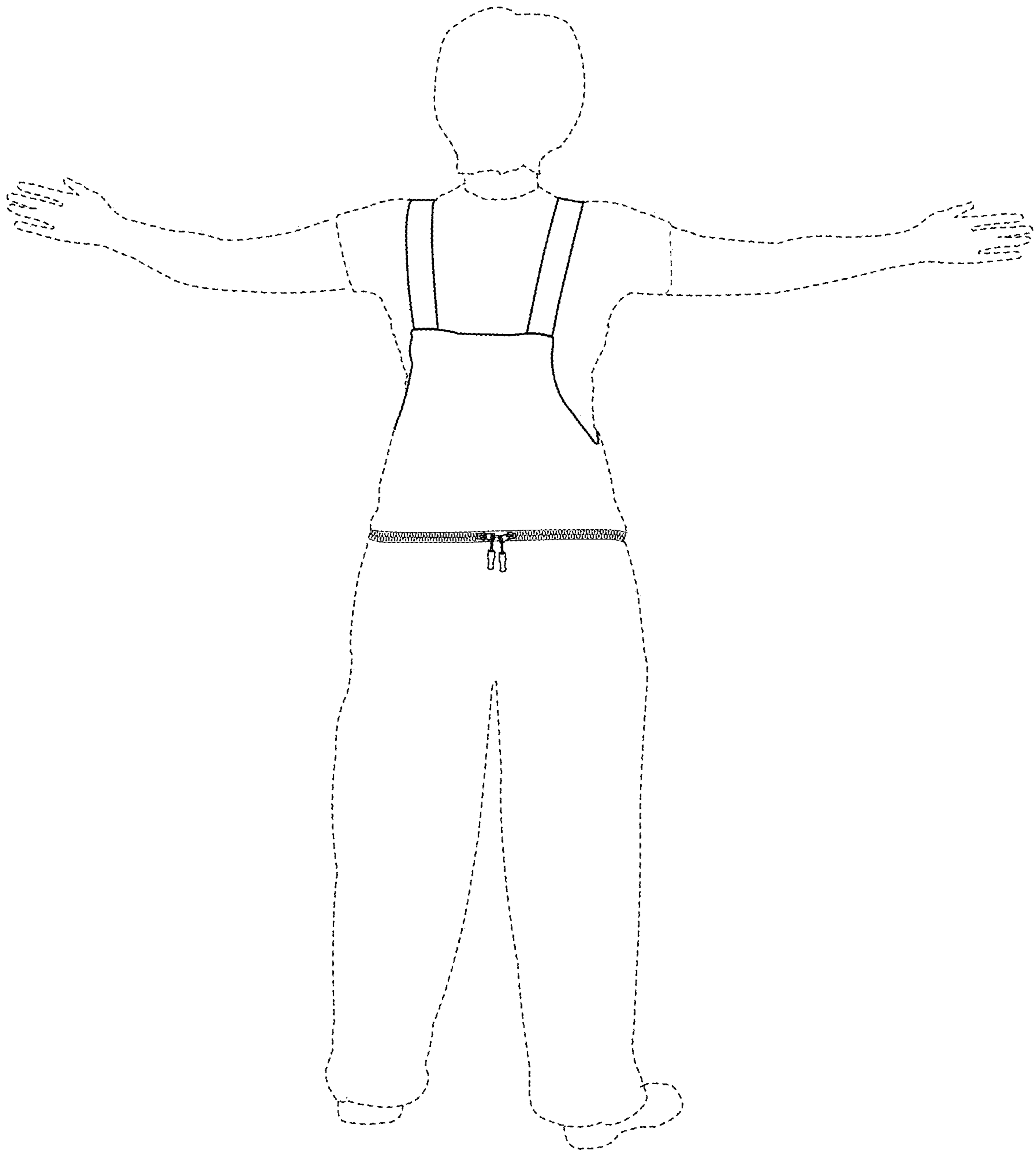

FIG. 1

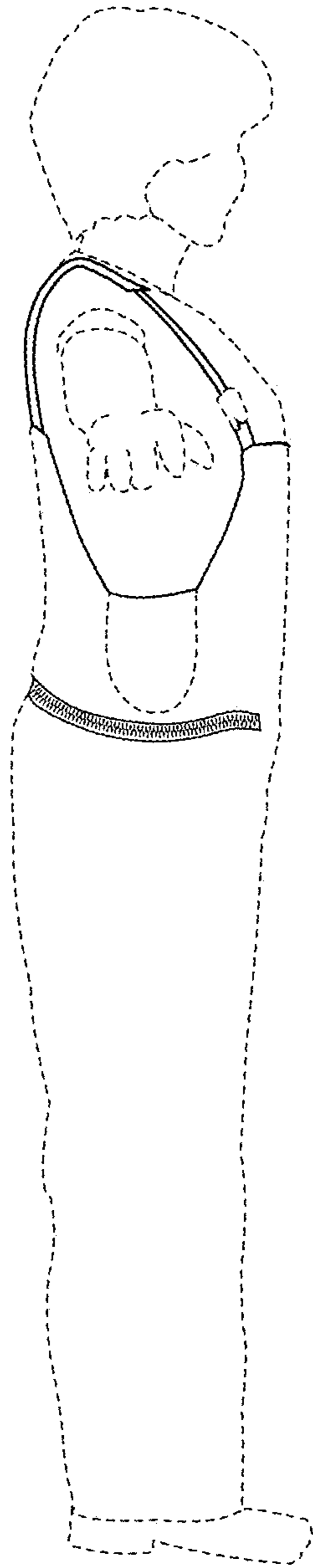

FIG. 2

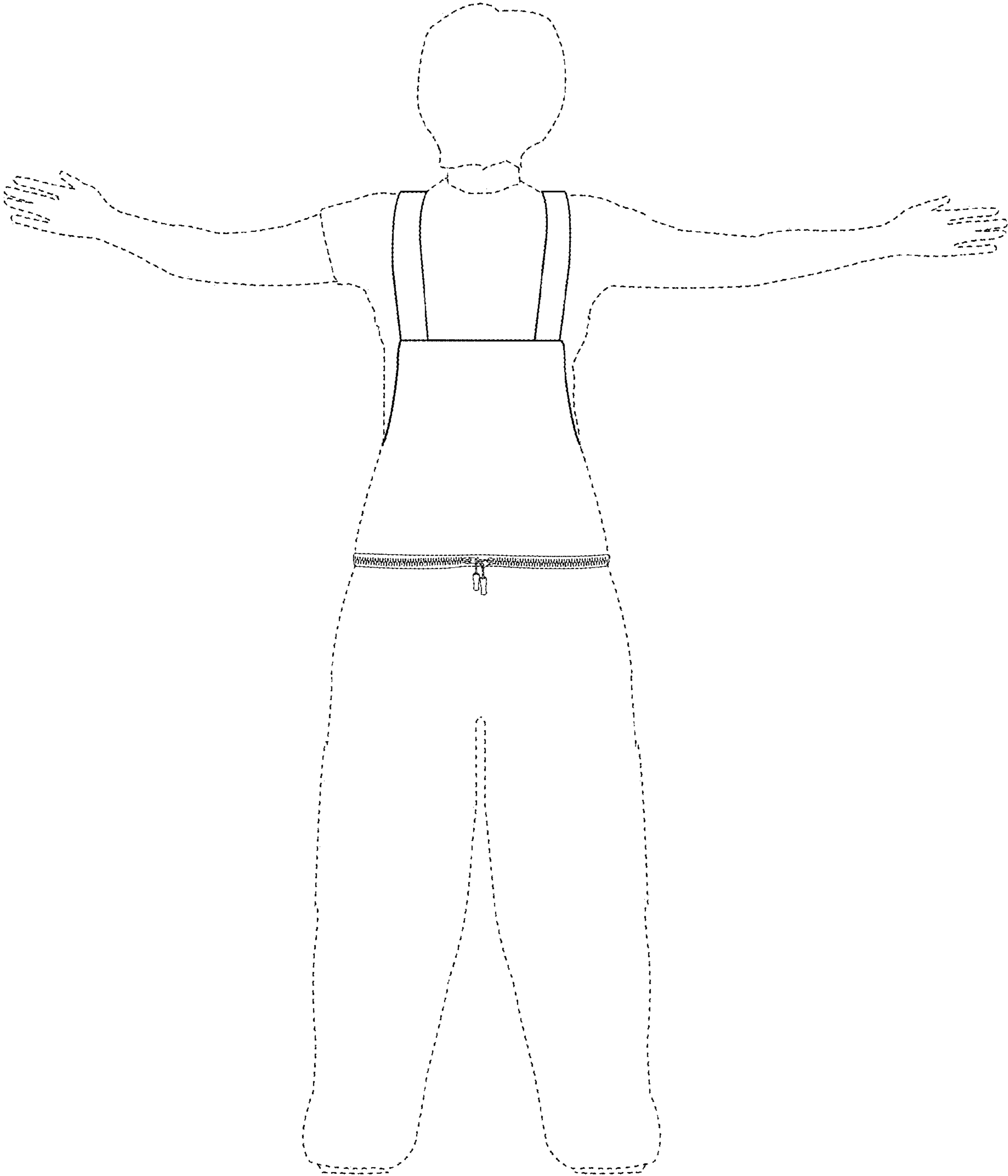

FIG. 3

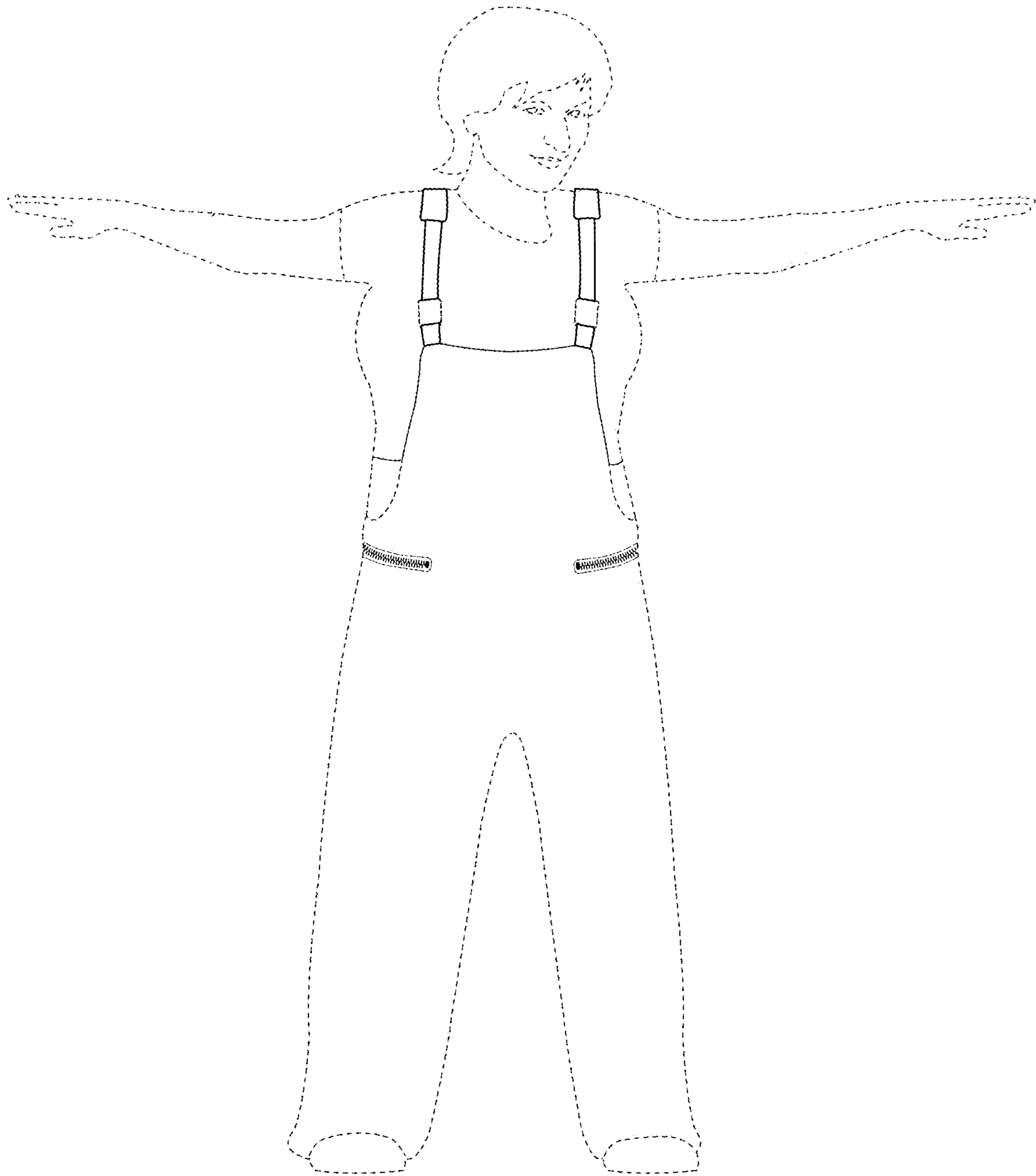

FIG. 4

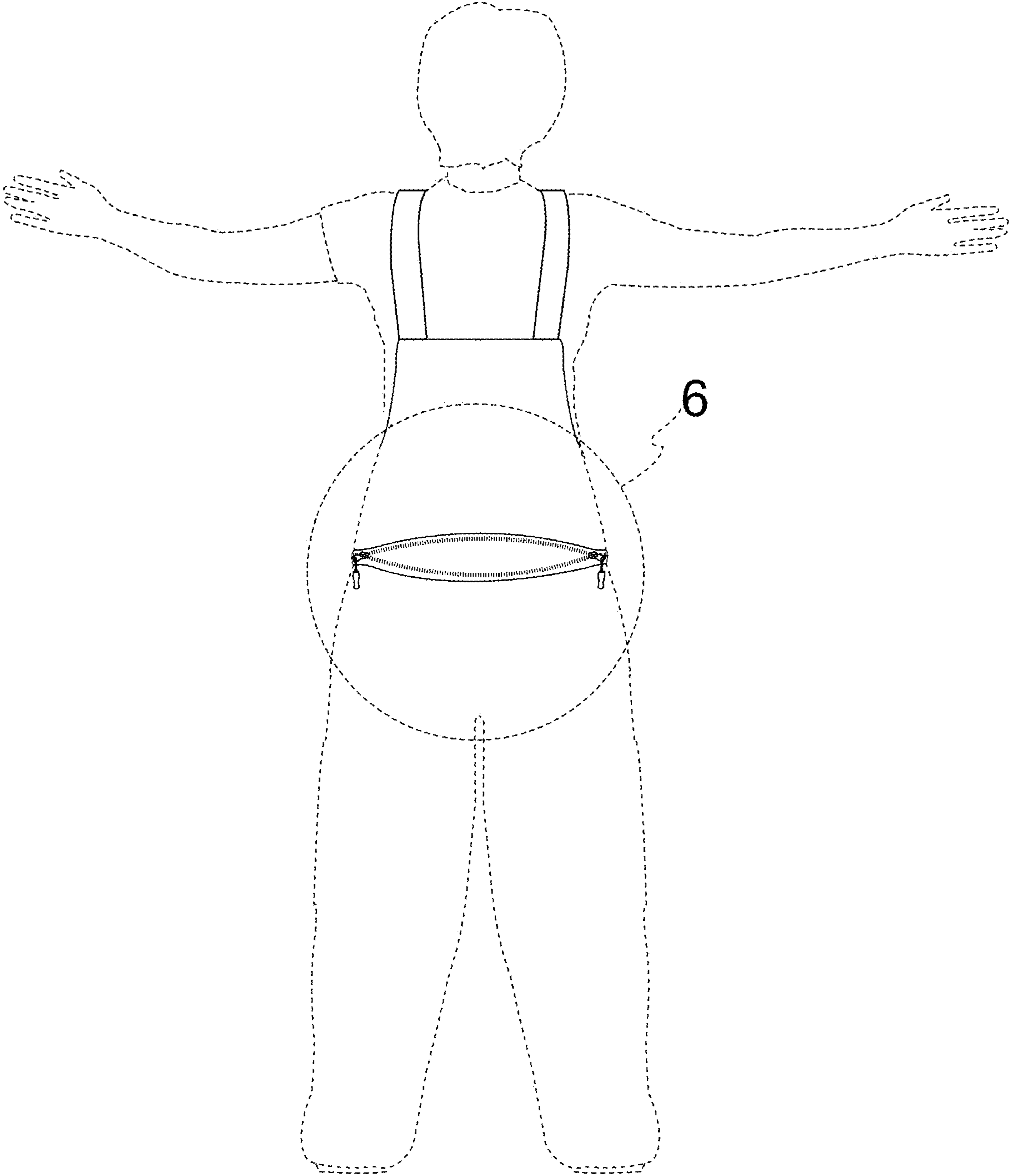

FIG. 5

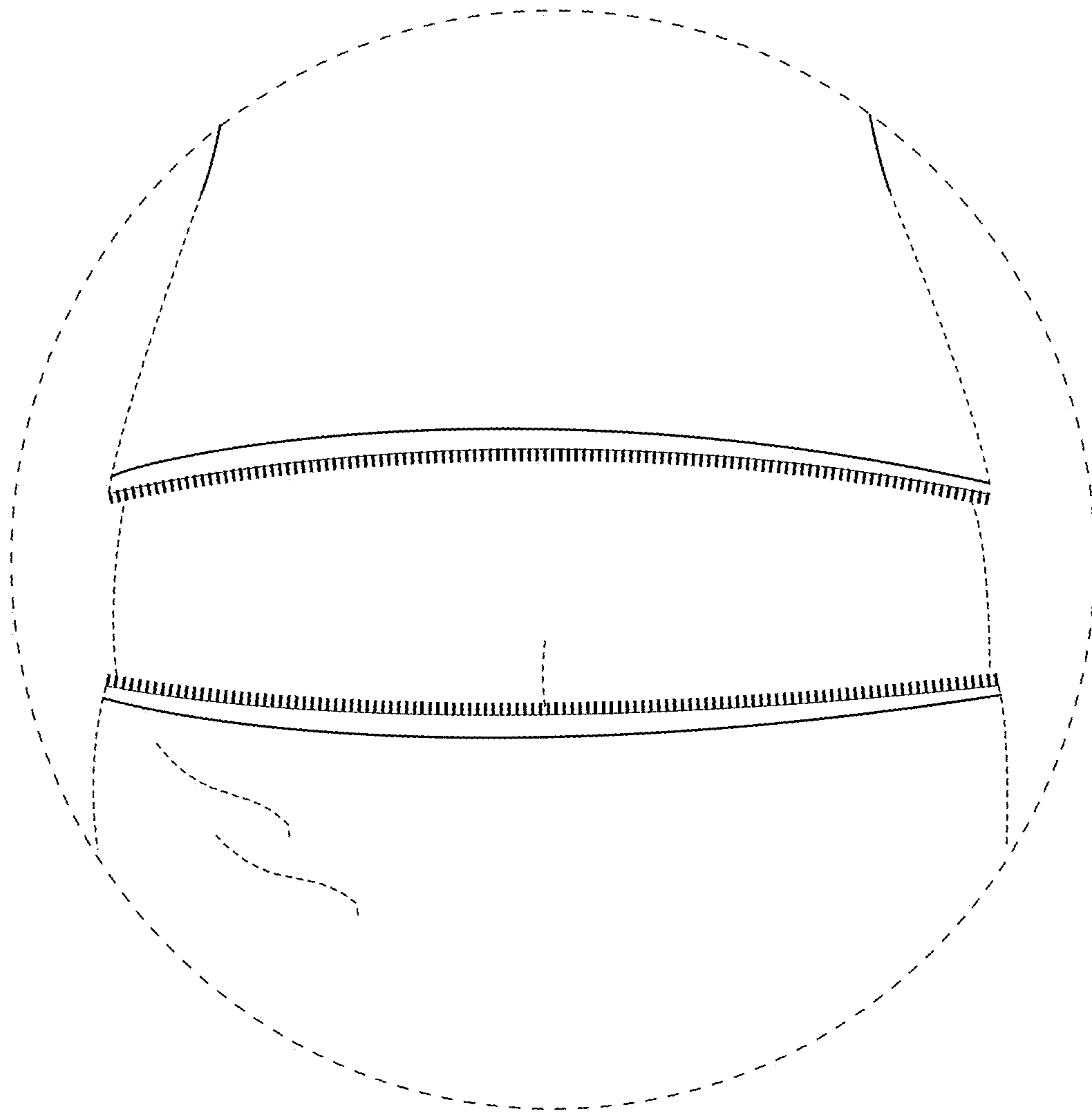

FIG. 6

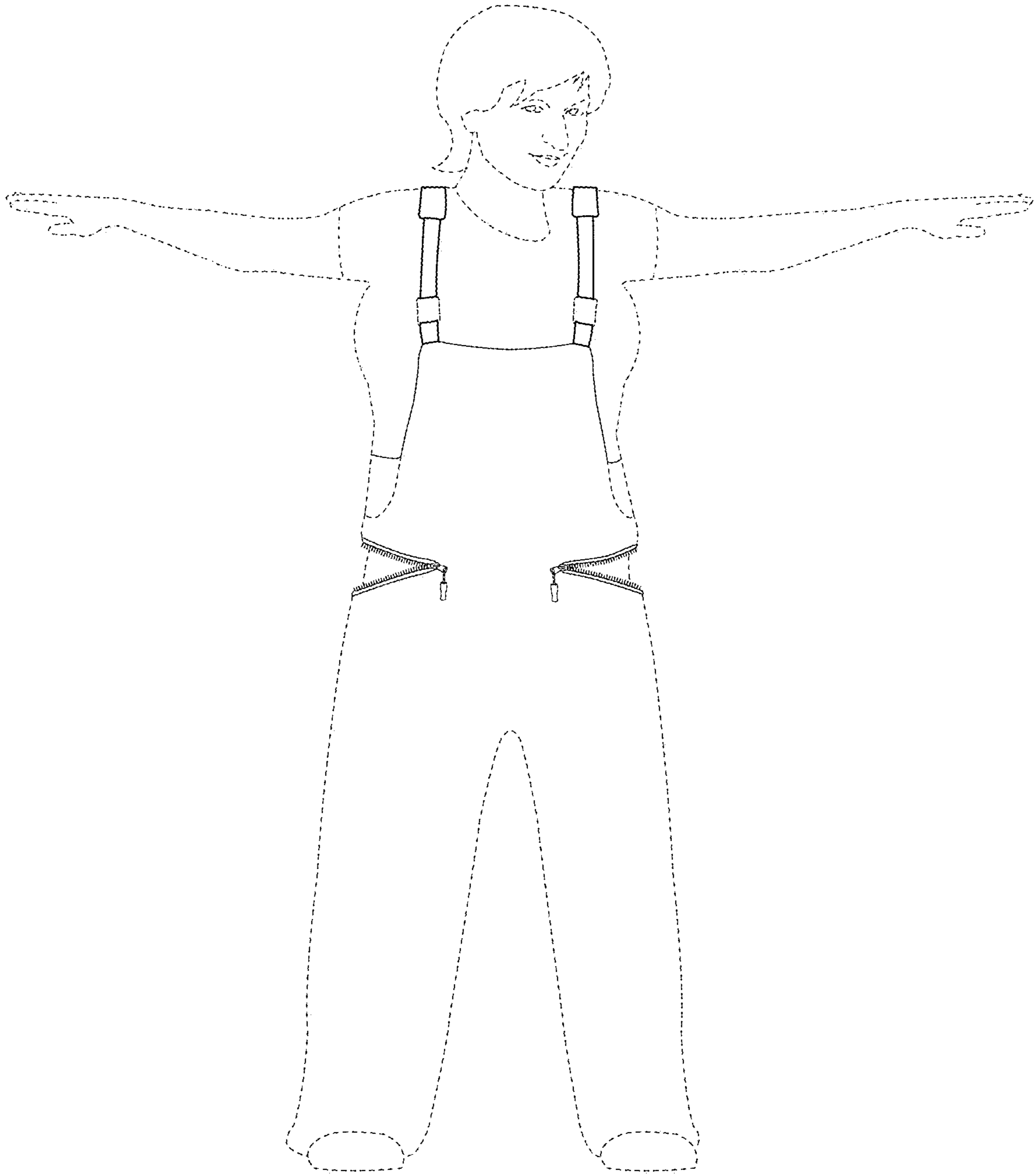

FIG. 7

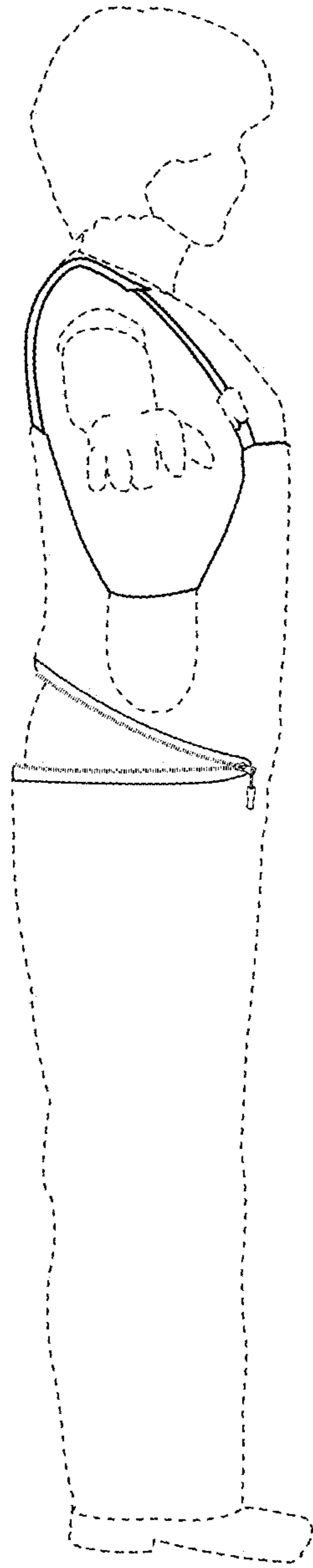

FIG. 8

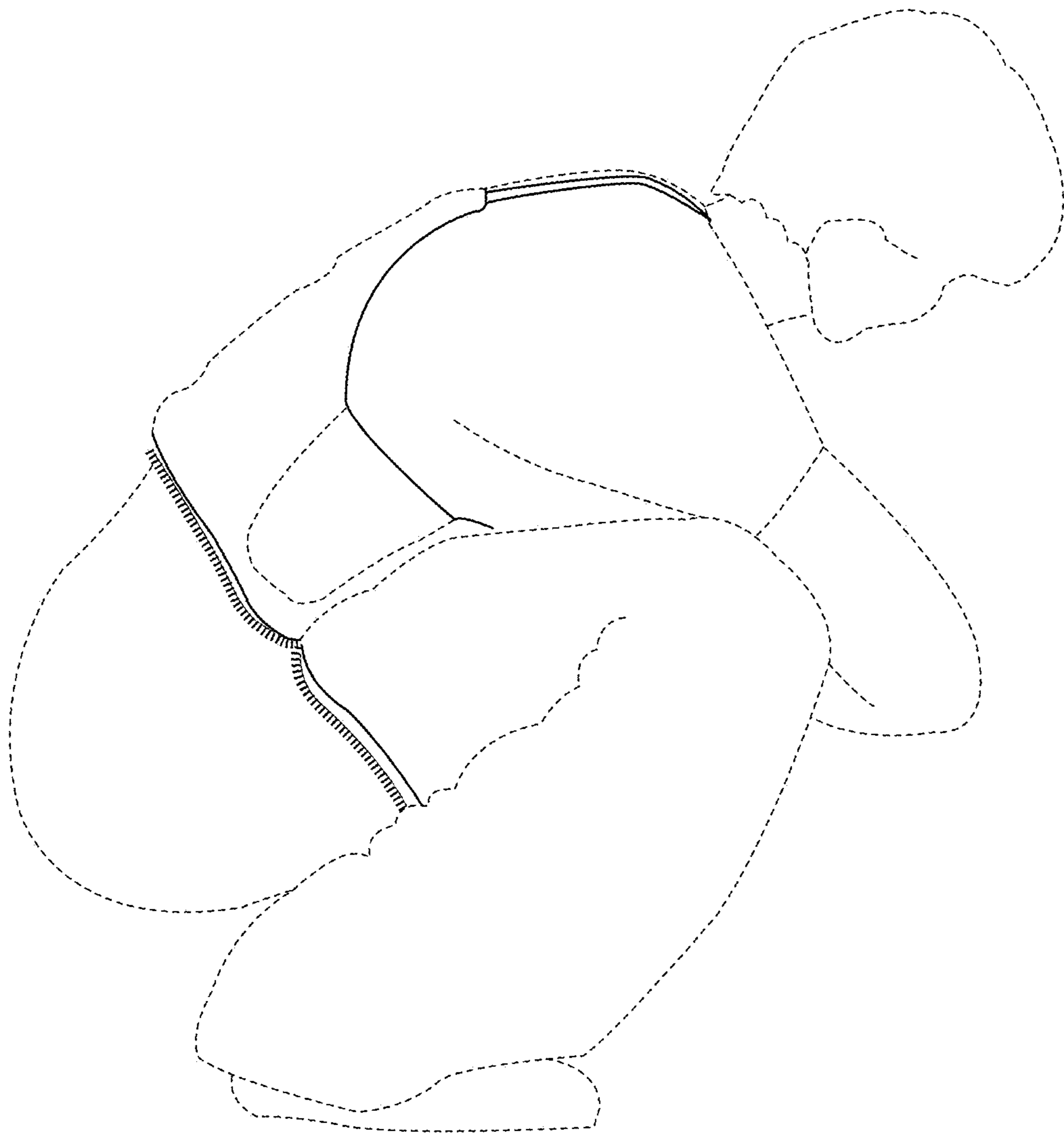

FIG. 9