



US00D920618S

(12) **United States Design Patent**
Cao

(10) **Patent No.:** **US D920,618 S**
(45) **Date of Patent:** **** May 25, 2021**

(54) **TROLLEY CART**

(71) Applicant: **Guohua Cao**, Guangdong (CN)

(72) Inventor: **Guohua Cao**, Guangdong (CN)

(**) Term: **15 Years**

(21) Appl. No.: **29/709,741**

(22) Filed: **Oct. 17, 2019**

(51) **LOC (13) Cl.** **12-02**

(52) **U.S. Cl.**
USPC **D34/21**

(58) **Field of Classification Search**
USPC D34/12-27; D3/304-315; D6/653.1,
D6/400, 684, 445
CPC A61G 12/001; B62B 3/00; B62B 3/002;
B62B 3/005
See application file for complete search history.

(56) **References Cited**

U.S. PATENT DOCUMENTS

D832,549 S	*	10/2018	Cao	D34/21
D846,824 S	*	4/2019	Cao	D34/21
D846,825 S	*	4/2019	Cao	D34/21
D850,753 S	*	6/2019	Cao	D34/21
D852,448 S	*	6/2019	Hu	D34/21
D858,928 S	*	9/2019	Cao	D34/21
D899,826 S	*	10/2020	Cheng	D6/675.1
D901,123 S	*	11/2020	Liu	D34/21

D901,816 S	*	11/2020	Liu	D34/21
D902,521 S	*	11/2020	Tsai	D34/21
2020/0231197 A1	*	7/2020	Liu	A47B 47/0083

OTHER PUBLICATIONS

Songmic Cart, announced Feb. 14, 2019 [online], [site visited Feb. 22, 2021], Available from internet, URL: https://www.amazon.com/SONGMICS-Rolling-Adjustable-Assembly-Bathroom/dp/B07NQHJL8M/ref=sr_1_7 (Year: 2019).*

* cited by examiner

Primary Examiner — George A Bugg
Assistant Examiner — Tamara L Hahn

(57) **CLAIM**

The ornamental design for a trolley cart, as shown.

DESCRIPTION

FIG. 1 is a front elevational view of a trolley cart showing my new design;
FIG. 2 is a rear elevational view thereof;
FIG. 3 is a left side view thereof;
FIG. 4 is a right side view thereof;
FIG. 5 is a top plan view thereof;
FIG. 6 is a bottom plan view thereof;
FIG. 7 is a perspective view thereof; and,
FIG. 8 is another perspective view thereof.

1 Claim, 7 Drawing Sheets

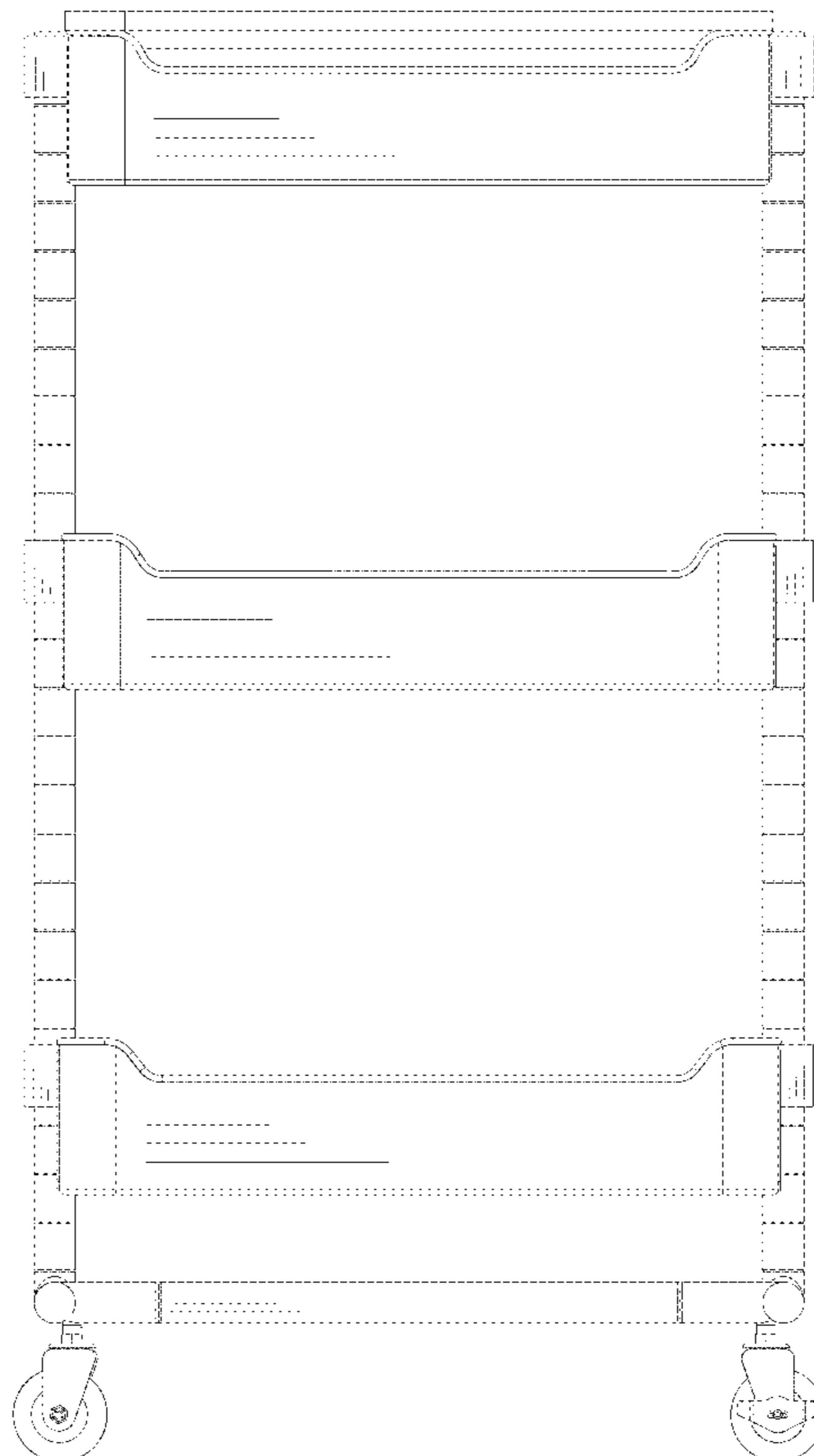

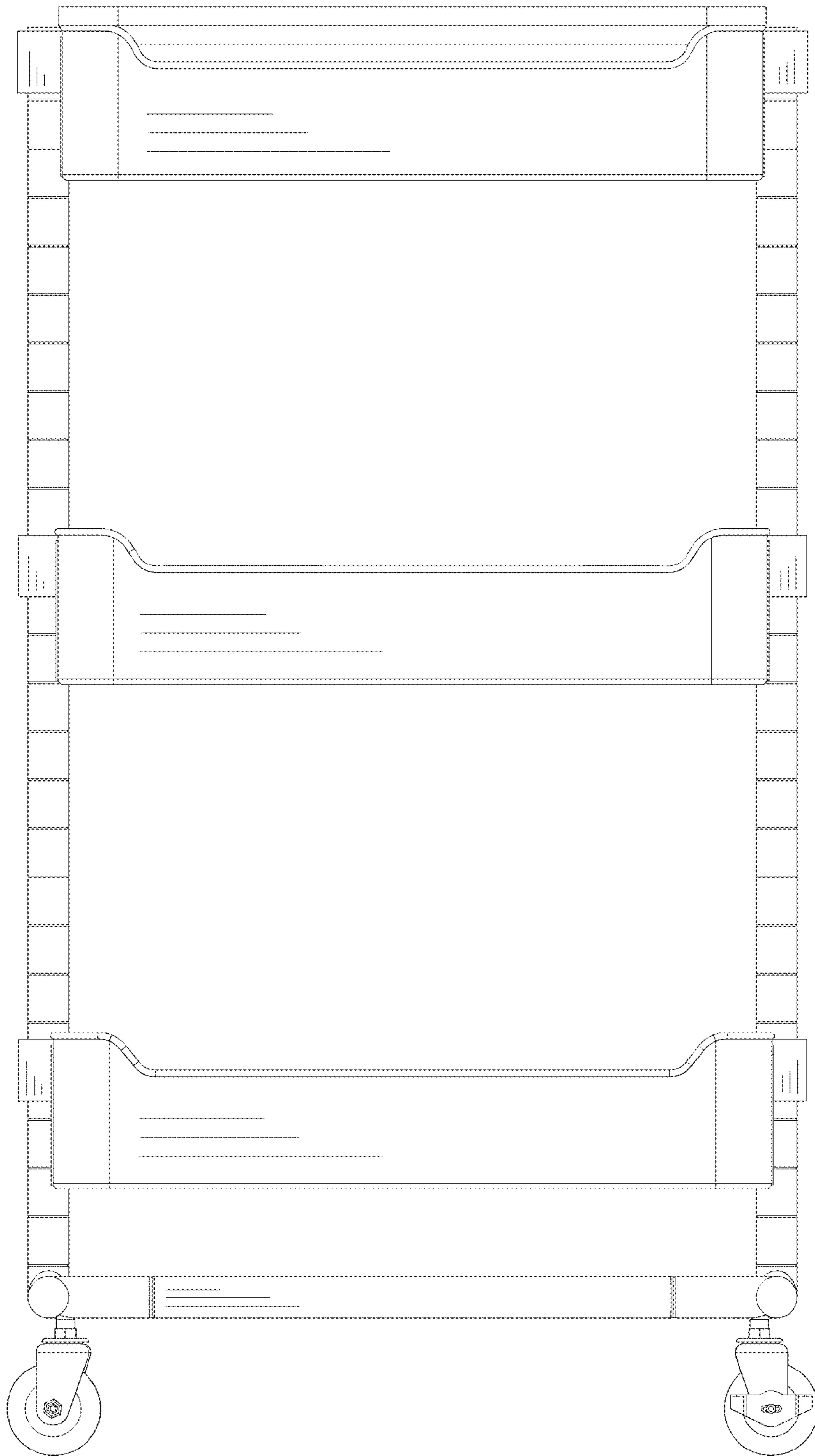

Fig. 1

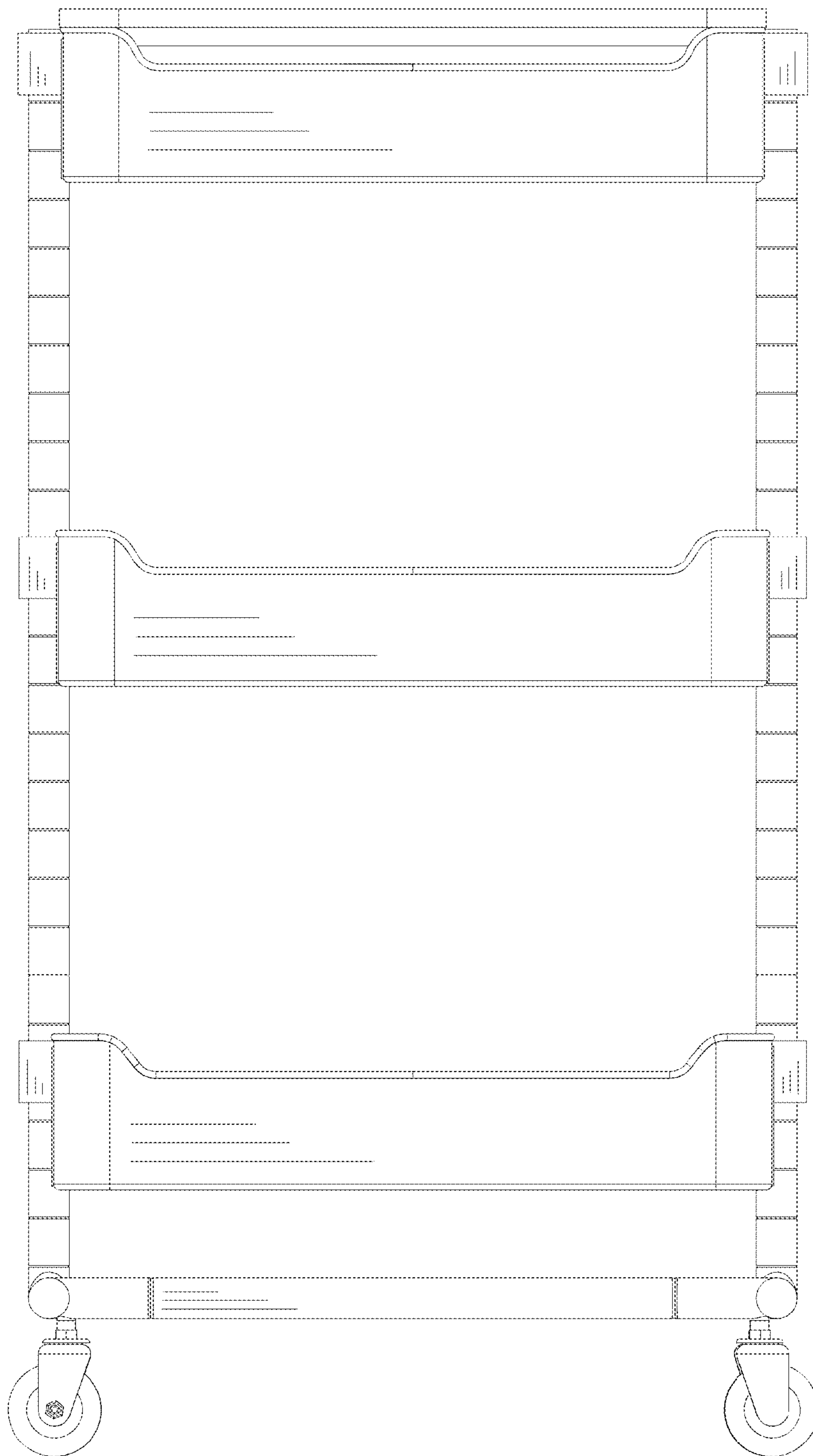

Fig. 2

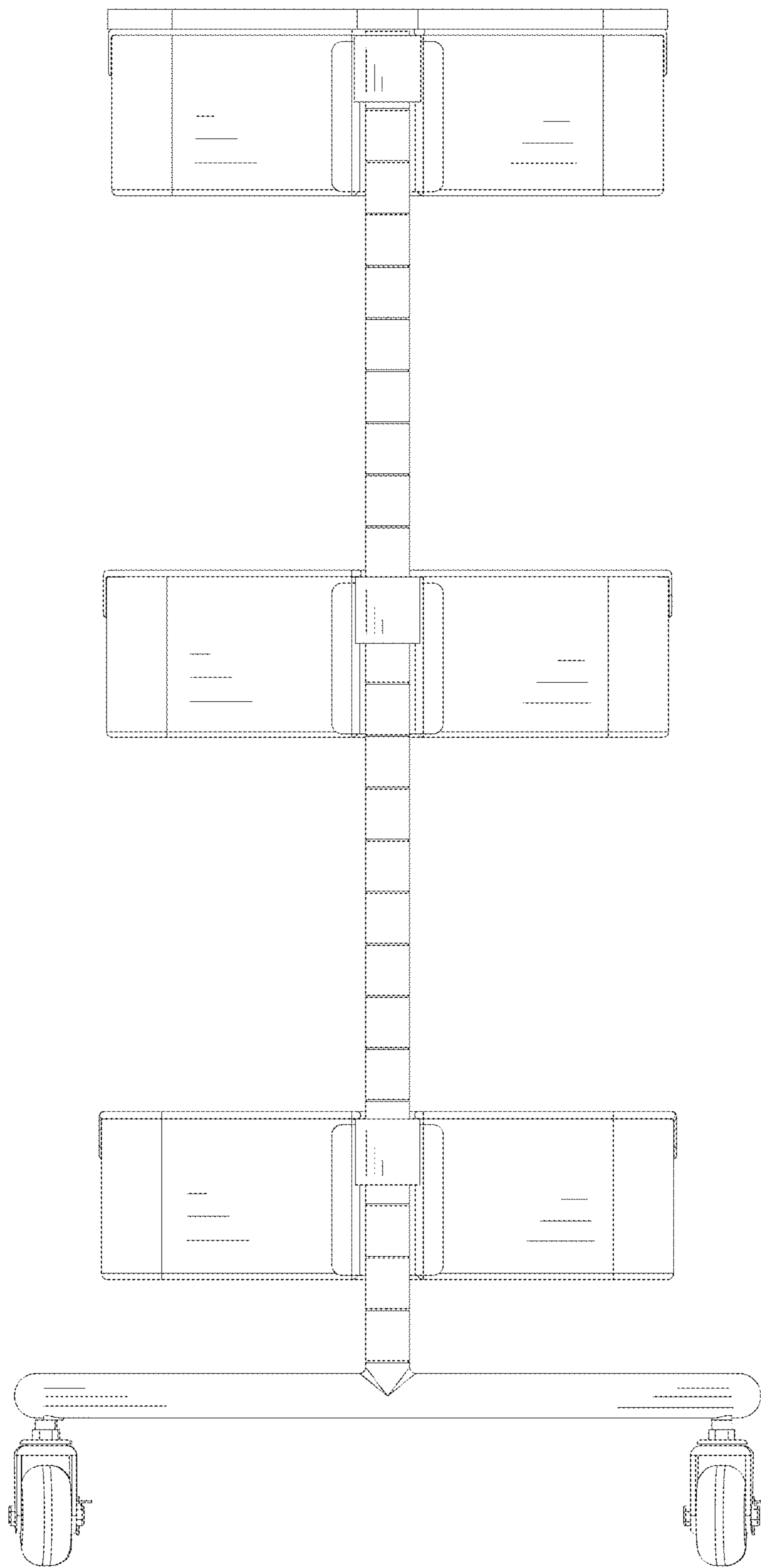

Fig. 3

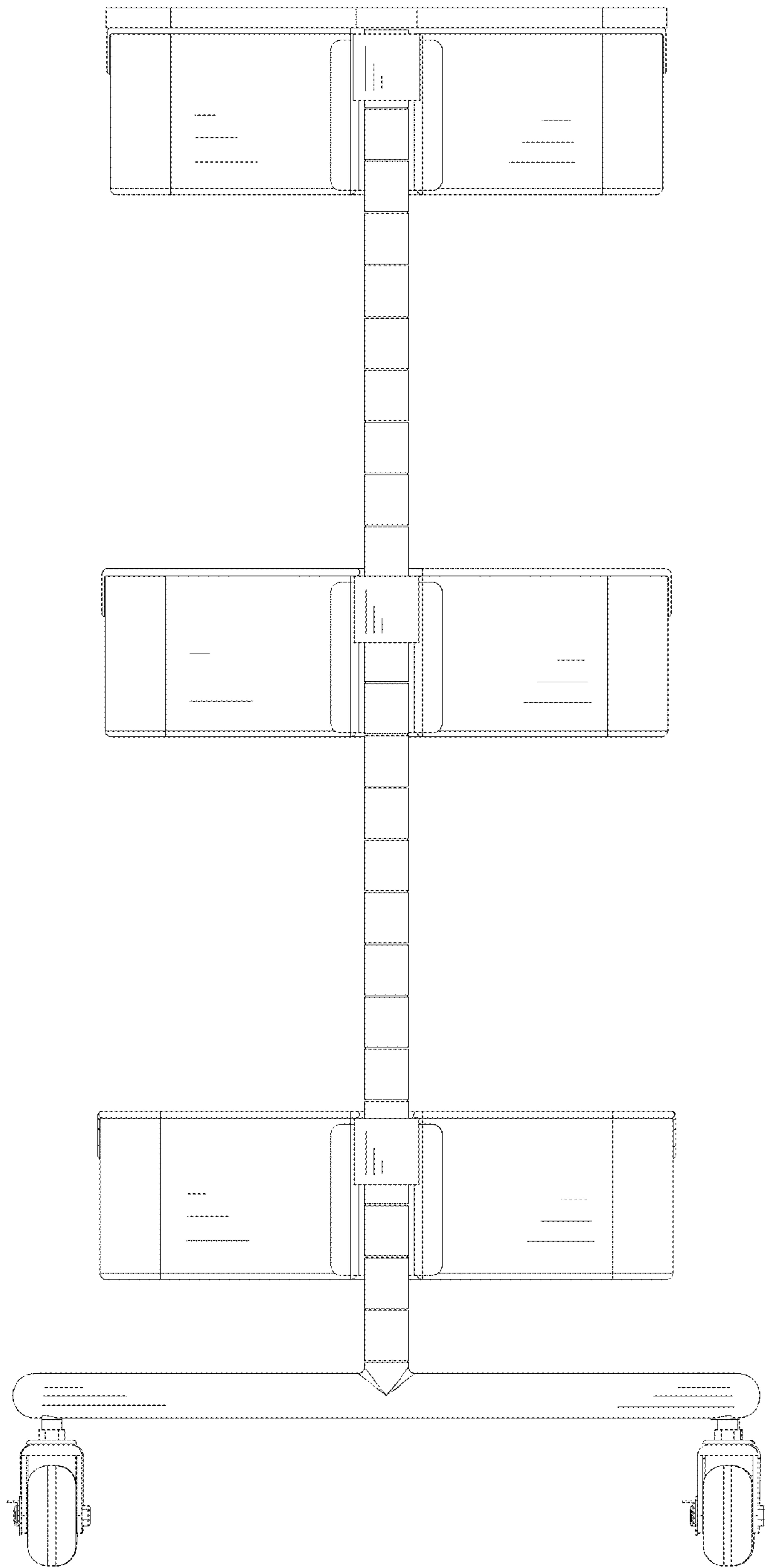

Fig. 4

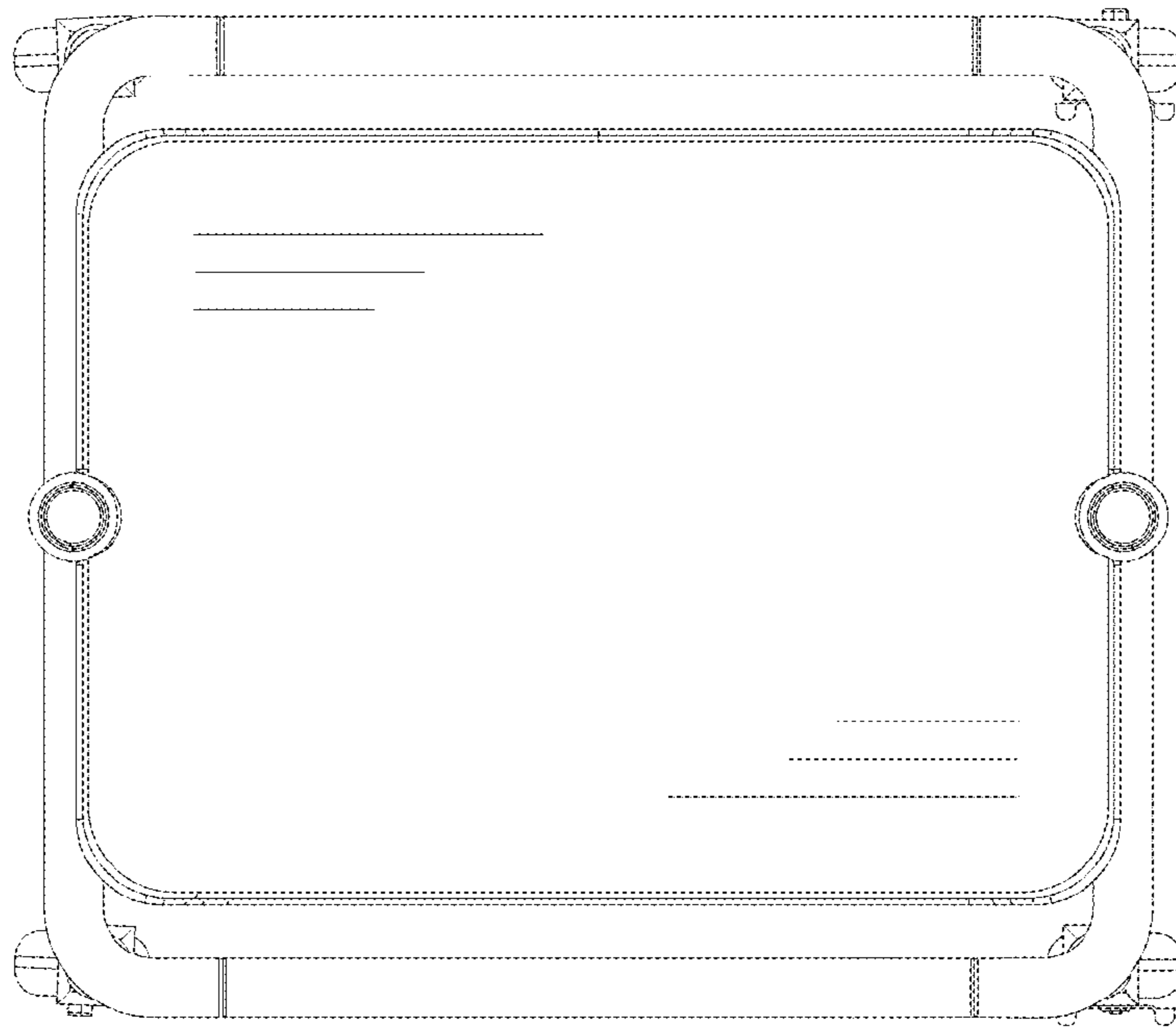

Fig. 5

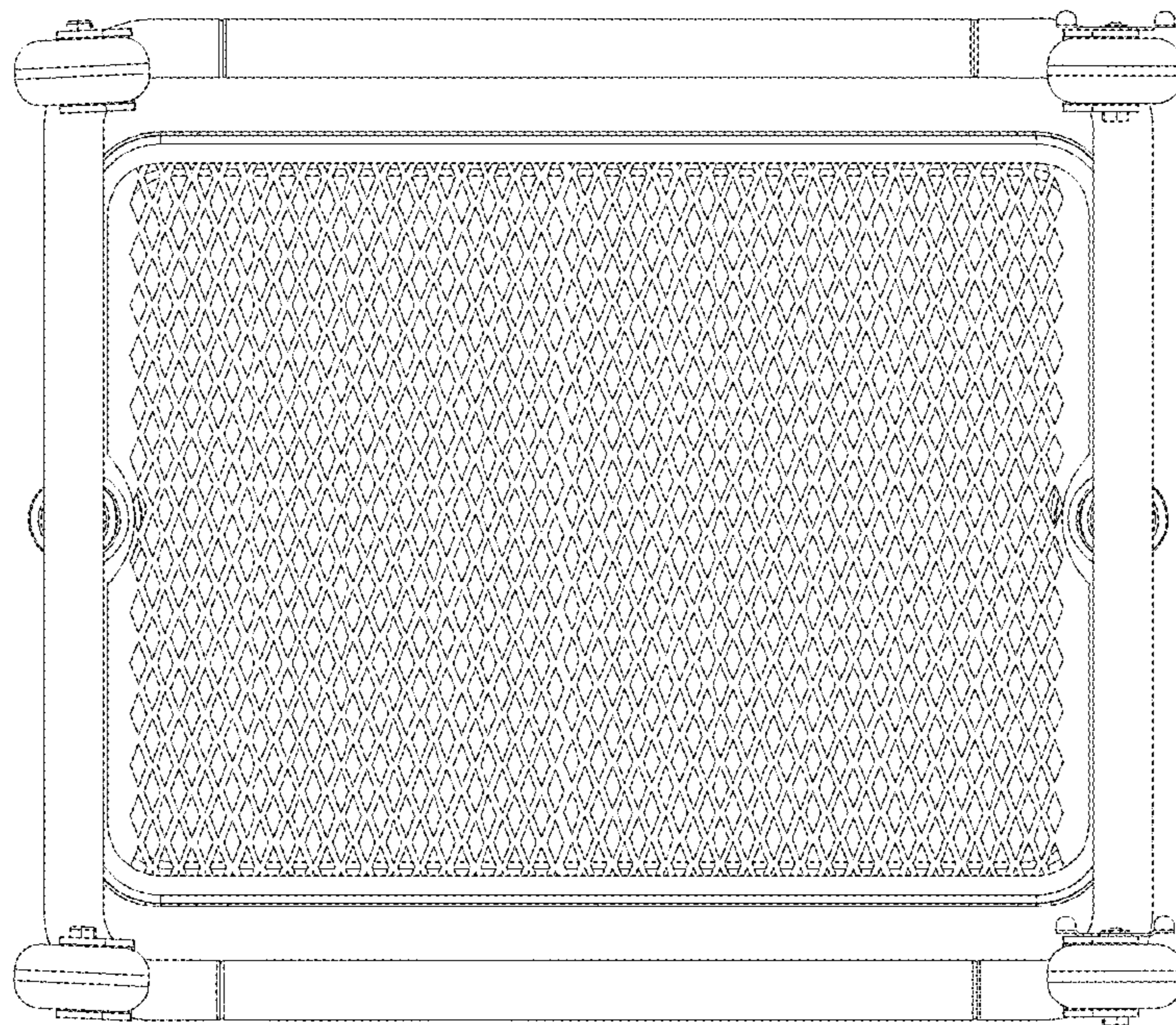

Fig. 6

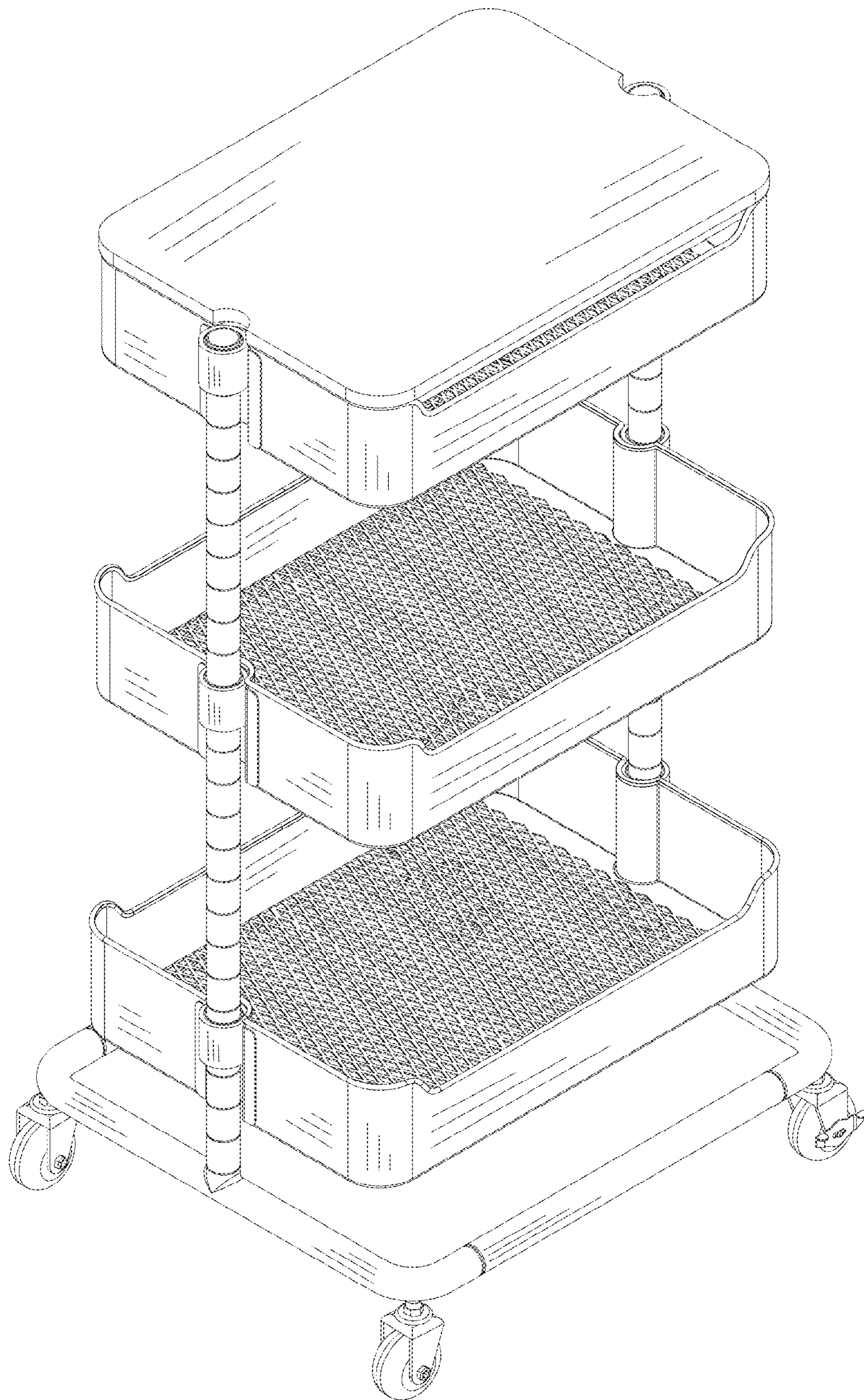

Fig. 7

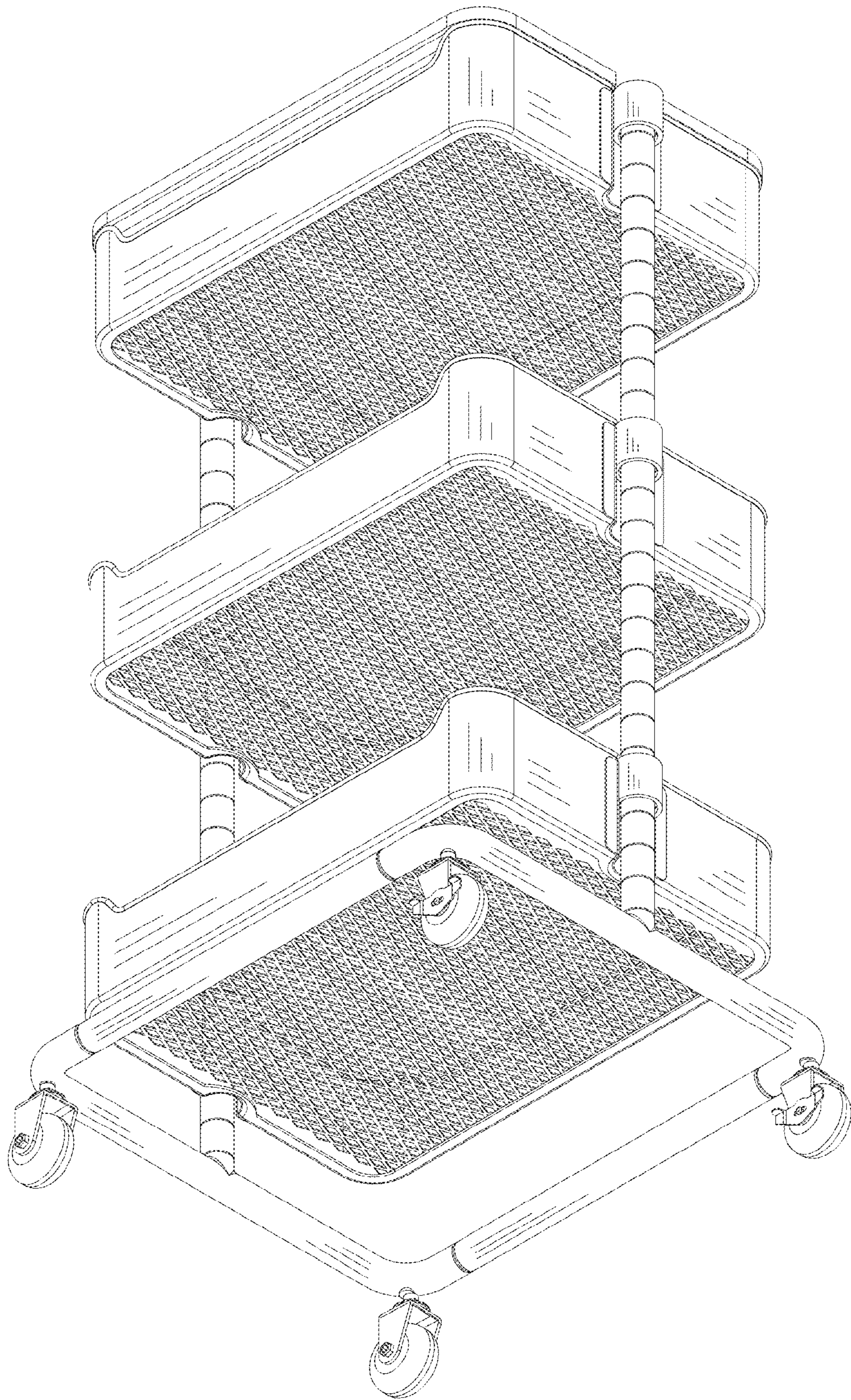

Fig. 8