



US00D920603S

(12) **United States Design Patent**  
**Huang**

(10) **Patent No.:** **US D920,603 S**

(45) **Date of Patent:** **\*\* May 25, 2021**

(54) **HANDHELD GARMENT STEAMER**

(71) Applicant: **Yun Huang**, Guangdong (CN)

(72) Inventor: **Yun Huang**, Guangdong (CN)

(\*\*) Term: **15 Years**

(21) Appl. No.: **29/695,883**

(22) Filed: **Jun. 24, 2019**

(51) **LOC (13) Cl.** ..... **15-05**

(52) **U.S. Cl.**  
USPC ..... **D32/17**

(58) **Field of Classification Search**  
USPC ..... D32/17, 18, 31, 35  
CPC ..... D06M 11/34; D06F 87/00; D06F 75/30;  
D06F 75/20; D06F 73/00; D06F 75/26;  
D06F 75/16; A61F 9/0026; B08B 9/00;  
B08B 3/00; A61L 2/07; F16L 37/40  
See application file for complete search history.

(56) **References Cited**

**U.S. PATENT DOCUMENTS**

|               |         |            |                       |
|---------------|---------|------------|-----------------------|
| D150,177 S *  | 7/1948  | Terraillon | D32/17                |
| D207,632 S *  | 5/1967  | Anderson   | D32/17                |
| D219,751 S *  | 1/1971  | Osrow      | D32/17                |
| D221,992 S *  | 9/1971  | Bluestein  | D32/17                |
| 3,620,055 A * | 11/1971 | Blachly    | D06F 75/30<br>68/222  |
| 3,654,780 A * | 4/1972  | Frank      | D06F 87/00<br>68/222  |
| D229,016 S *  | 11/1973 | Plasko     | D32/17                |
| D232,802 S *  | 9/1974  | Steinkamp  | D32/17                |
| D233,209 S *  | 10/1974 | Terraillon | D32/17                |
| 3,969,607 A * | 7/1976  | Osrow      | D06F 87/00<br>392/335 |
| 4,206,340 A * | 6/1980  | Osrow      | D06F 75/16<br>219/245 |
| D287,892 S *  | 1/1987  | Rosa       | D32/17                |
| D388,562 S *  | 12/1997 | Doria      | D32/17                |
| D421,670 S *  | 3/2000  | Schupp     | D32/17                |

|                |         |              |                        |
|----------------|---------|--------------|------------------------|
| 6,275,653 B1 * | 8/2001  | Montipo'     | B08B 9/00<br>392/405   |
| D465,309 S *   | 11/2002 | Foersterling | D32/35                 |
| 6,513,269 B2 * | 2/2003  | Kobayashi    | D06F 75/20<br>38/93    |
| D473,987 S *   | 4/2003  | Foersterling | D32/35                 |
| D481,183 S *   | 10/2003 | Mangano      | D32/17                 |
| 6,986,217 B2 * | 1/2006  | Leung        | D06F 73/00<br>38/77.83 |
| D516,759 S *   | 3/2006  | Lam          | D32/17                 |
| D587,866 S *   | 3/2009  | Mangano      | D32/17                 |
| D592,366 S *   | 5/2009  | Mangano      | D32/17                 |
| D598,614 S *   | 8/2009  | Lam          | D32/17                 |

(Continued)

**OTHER PUBLICATIONS**

Hand Garment Steamer [https://www.amazon.com/dp/B089QT4NSV/ref=sspa\\_dk\\_detail\\_4](https://www.amazon.com/dp/B089QT4NSV/ref=sspa_dk_detail_4) (Year: 2020).\*

(Continued)

*Primary Examiner* — Michelle E. Wilson  
*Assistant Examiner* — Richard E Yenchesky

(57) **CLAIM**

I claim the ornamental design for a handheld garment steamer, as shown and described.

**DESCRIPTION**

FIG. 1 is a front view of a handheld garment steamer showing my new design;  
FIG. 2 is a rear elevational view thereof;  
FIG. 3 is a left side elevational view thereof;  
FIG. 4 is a right side elevational view thereof;  
FIG. 5 is a top plan view thereof;  
FIG. 6 is a bottom plan view thereof; and,  
FIG. 7 is a perspective view thereof.  
The broken lines shown depict environment that forms no part of the claimed design.

**1 Claim, 7 Drawing Sheets**

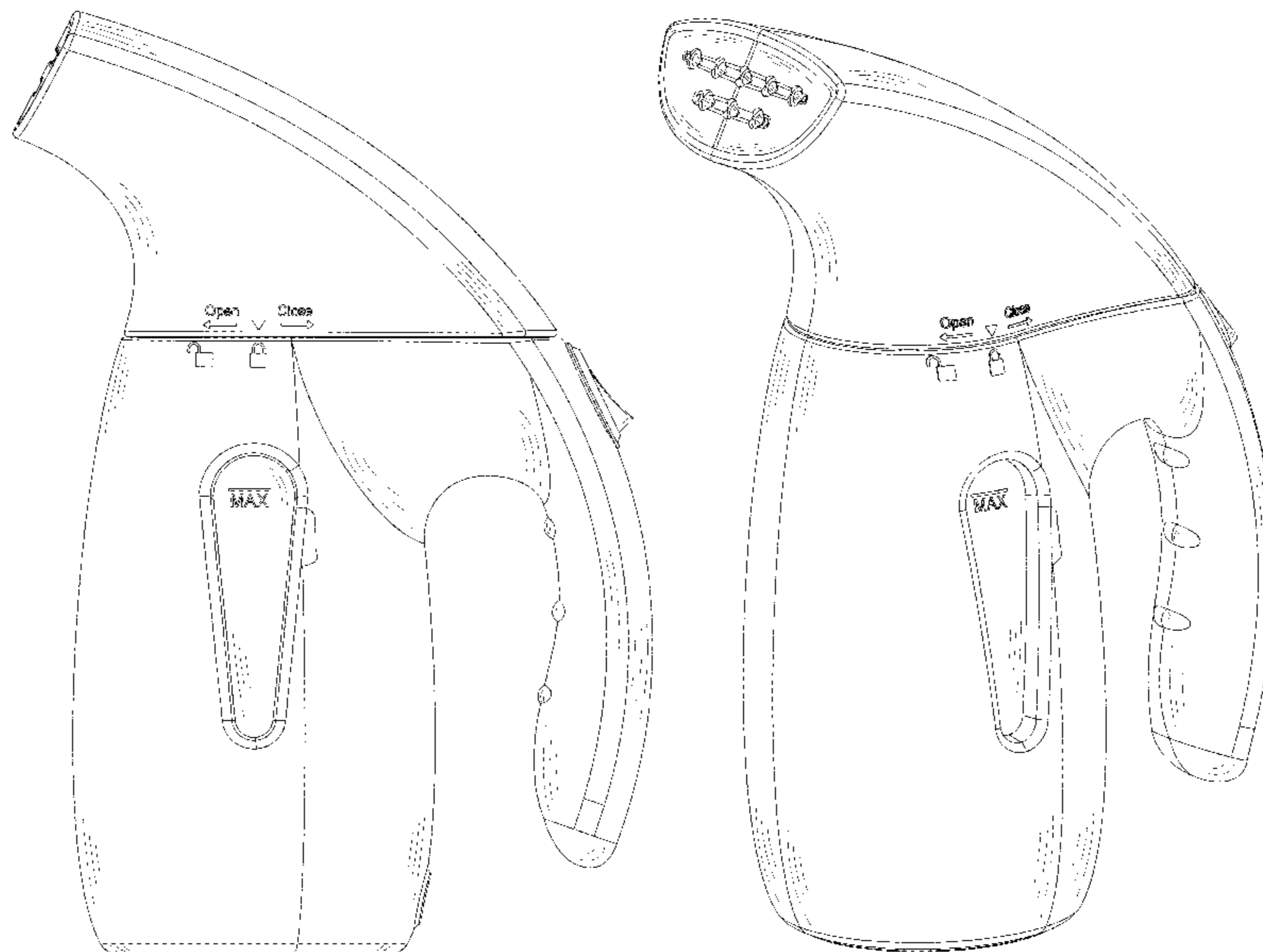

(56)

**References Cited**

U.S. PATENT DOCUMENTS

7,661,212 B2 \* 2/2010 Hahn ..... D06F 75/20  
 38/81  
 D611,208 S \* 3/2010 Lam ..... D32/17  
 7,721,474 B2 \* 5/2010 Jiang ..... D06F 75/26  
 38/77.7  
 D620,208 S \* 7/2010 Mangano ..... D32/17  
 D620,651 S \* 7/2010 Enervold ..... D32/17  
 D623,363 S \* 9/2010 Ediger ..... D32/17  
 D634,493 S \* 3/2011 Breit ..... D32/17  
 D648,494 S \* 11/2011 Vrdoljak ..... D32/17  
 D674,564 S \* 1/2013 Mangano ..... D32/17  
 D707,902 S \* 6/2014 Mangano ..... D32/17  
 D716,007 S \* 10/2014 Mangano ..... D32/17  
 D725,326 S \* 3/2015 Spencer ..... D32/17  
 D734,575 S \* 7/2015 Zeng ..... D32/18  
 D753,354 S \* 4/2016 Casini ..... D32/17  
 D771,331 S \* 11/2016 Chaklos ..... D32/17  
 D820,540 S \* 6/2018 Cartwright ..... D32/31  
 D821,668 S \* 6/2018 Cartwright ..... D32/31

D844,263 S \* 3/2019 Ediger ..... D32/17  
 2005/0125934 A1 \* 6/2005 Reese ..... F16L 37/40  
 15/320  
 2008/0022480 A1 \* 1/2008 Lee ..... B08B 3/00  
 15/320  
 2010/0024492 A1 \* 2/2010 Leung ..... D06F 73/00  
 68/222  
 2010/0269287 A1 \* 10/2010 Vrdoljak ..... A61L 2/07  
 15/322  
 2018/0200106 A1 \* 7/2018 Zoumalan ..... A61F 9/0026  
 2020/0362505 A1 \* 11/2020 Razouki ..... D06M 11/34

OTHER PUBLICATIONS

Portable Garment Steamer [https://www.amazon.com/hOmeLabs-Handheld-Steamer-Clothes-Portable/dp/B07XFR31SL/ref=pd\\_di\\_sccai\\_1](https://www.amazon.com/hOmeLabs-Handheld-Steamer-Clothes-Portable/dp/B07XFR31SL/ref=pd_di_sccai_1) (Year: 2020).\*  
 Handheld Steamer <https://www.yoybuy.com/pd/allshHIBbZ1MBMb9l7cT.html> (Year: 2020).\*

\* cited by examiner

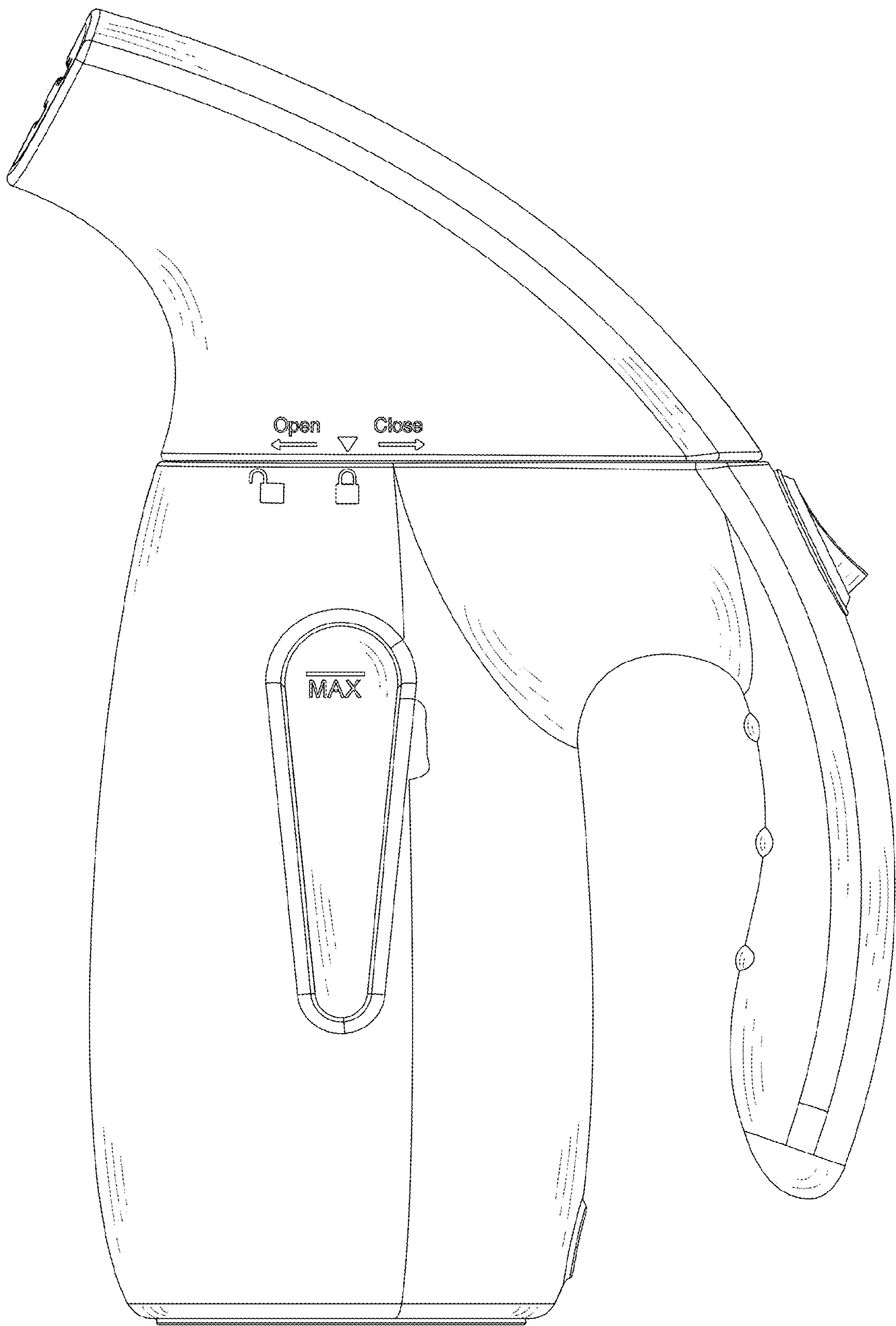

FIG. 1

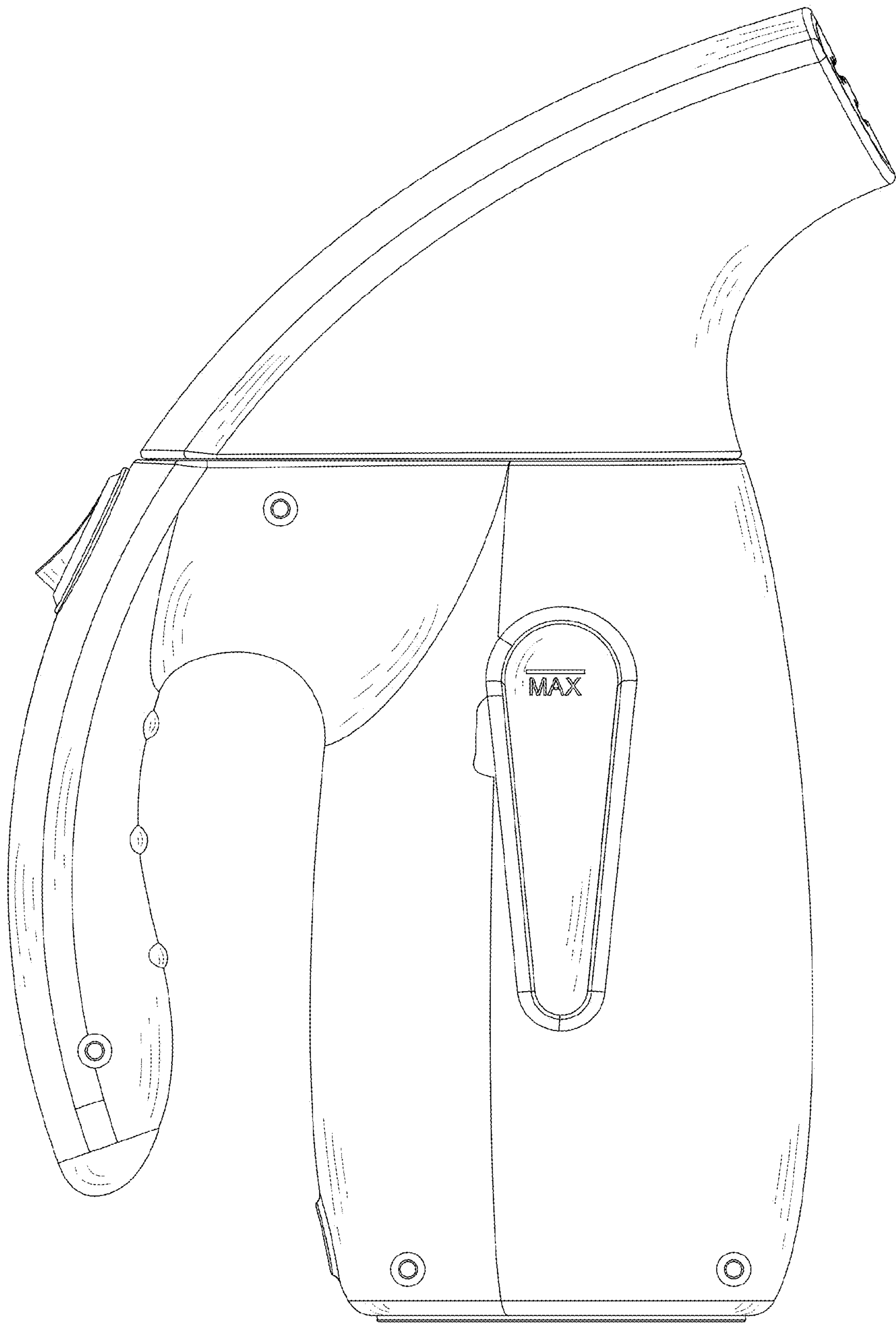

FIG. 2



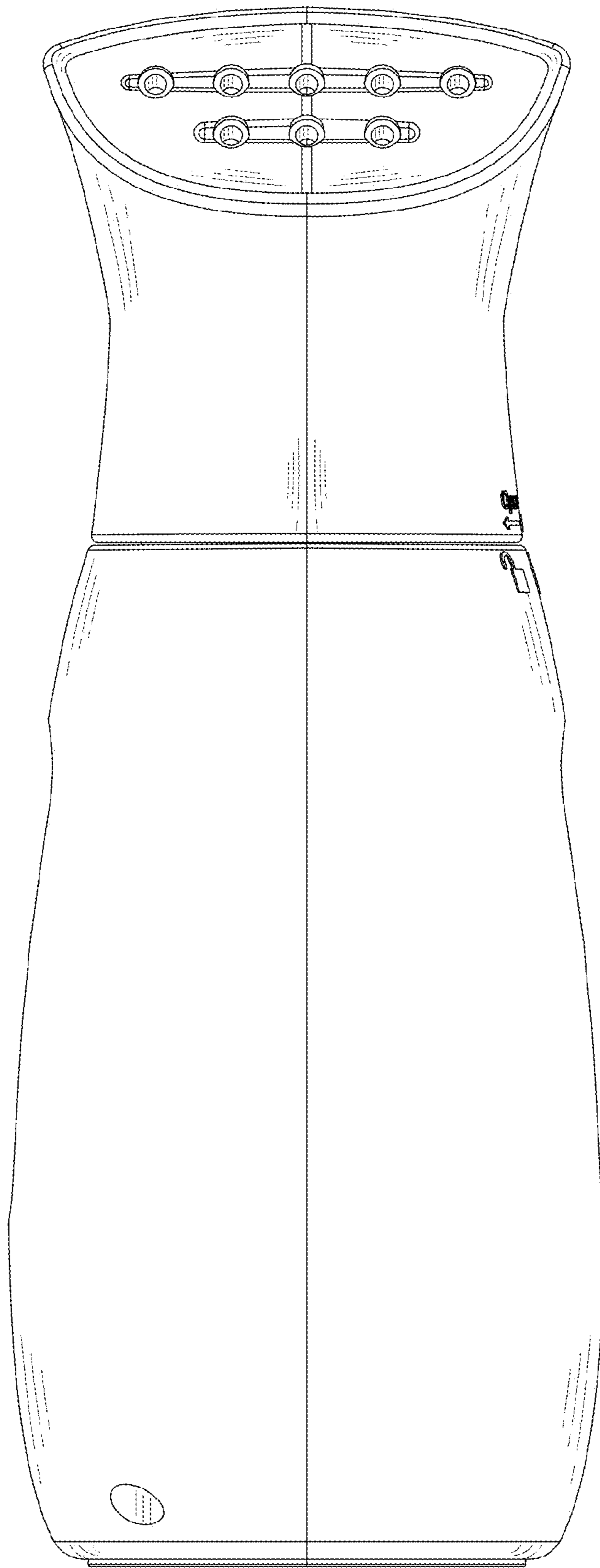

FIG. 3

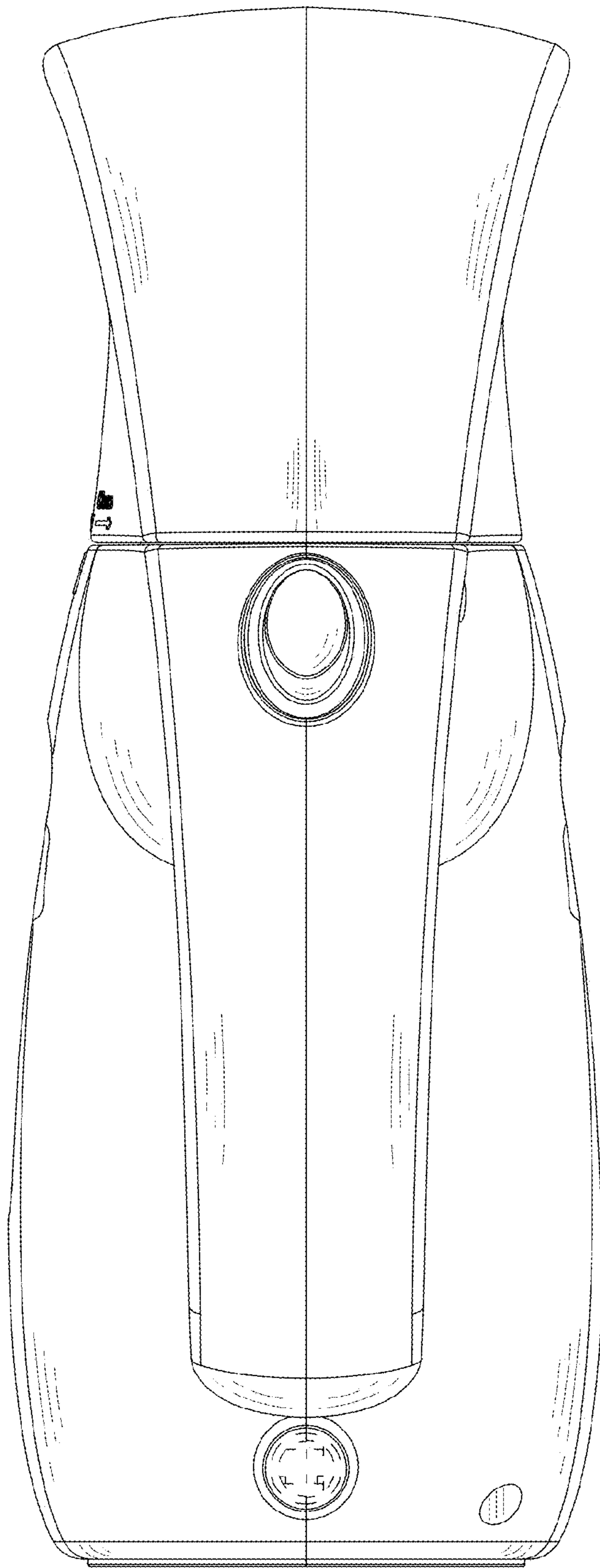

FIG. 4

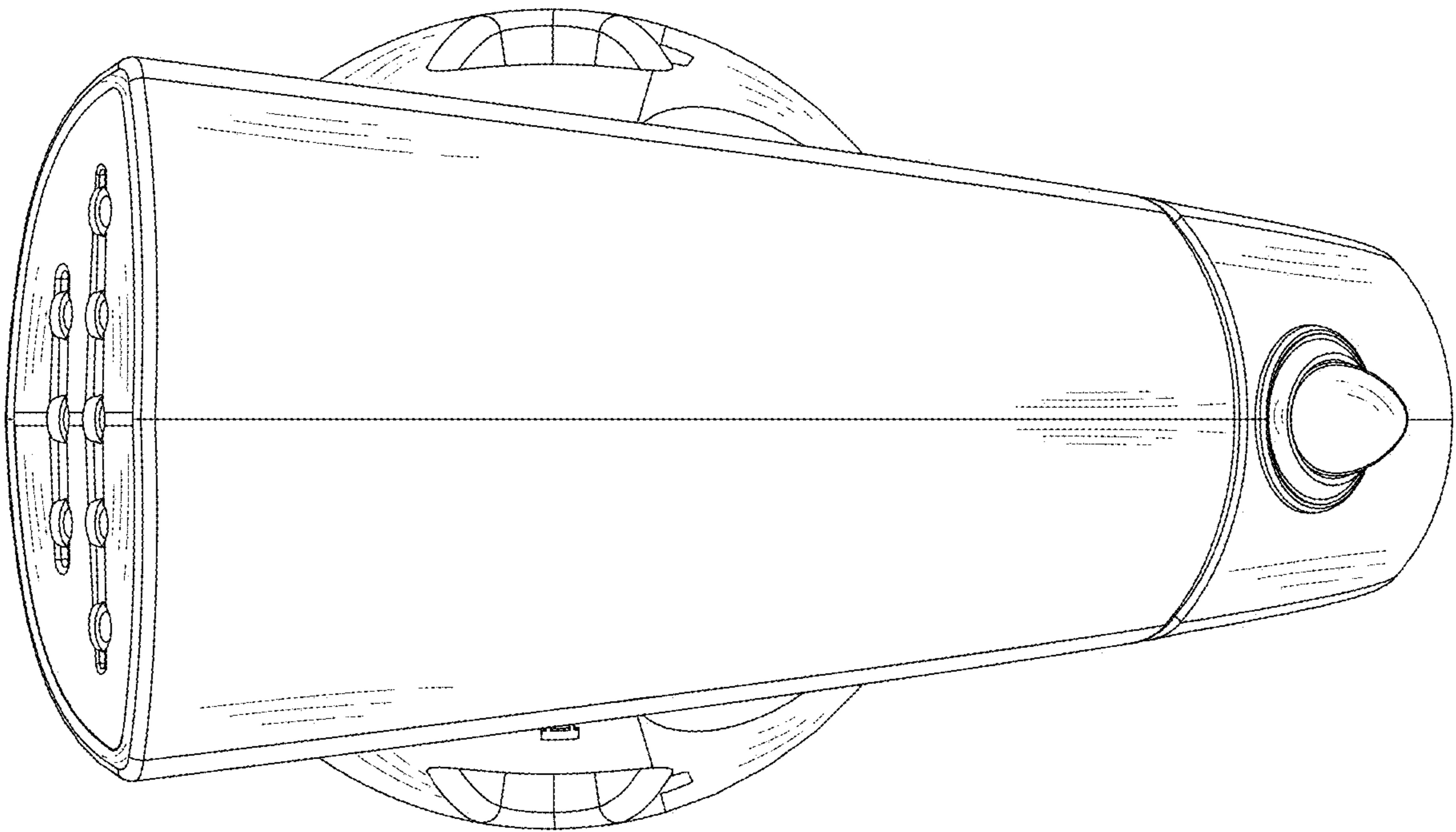

FIG. 5

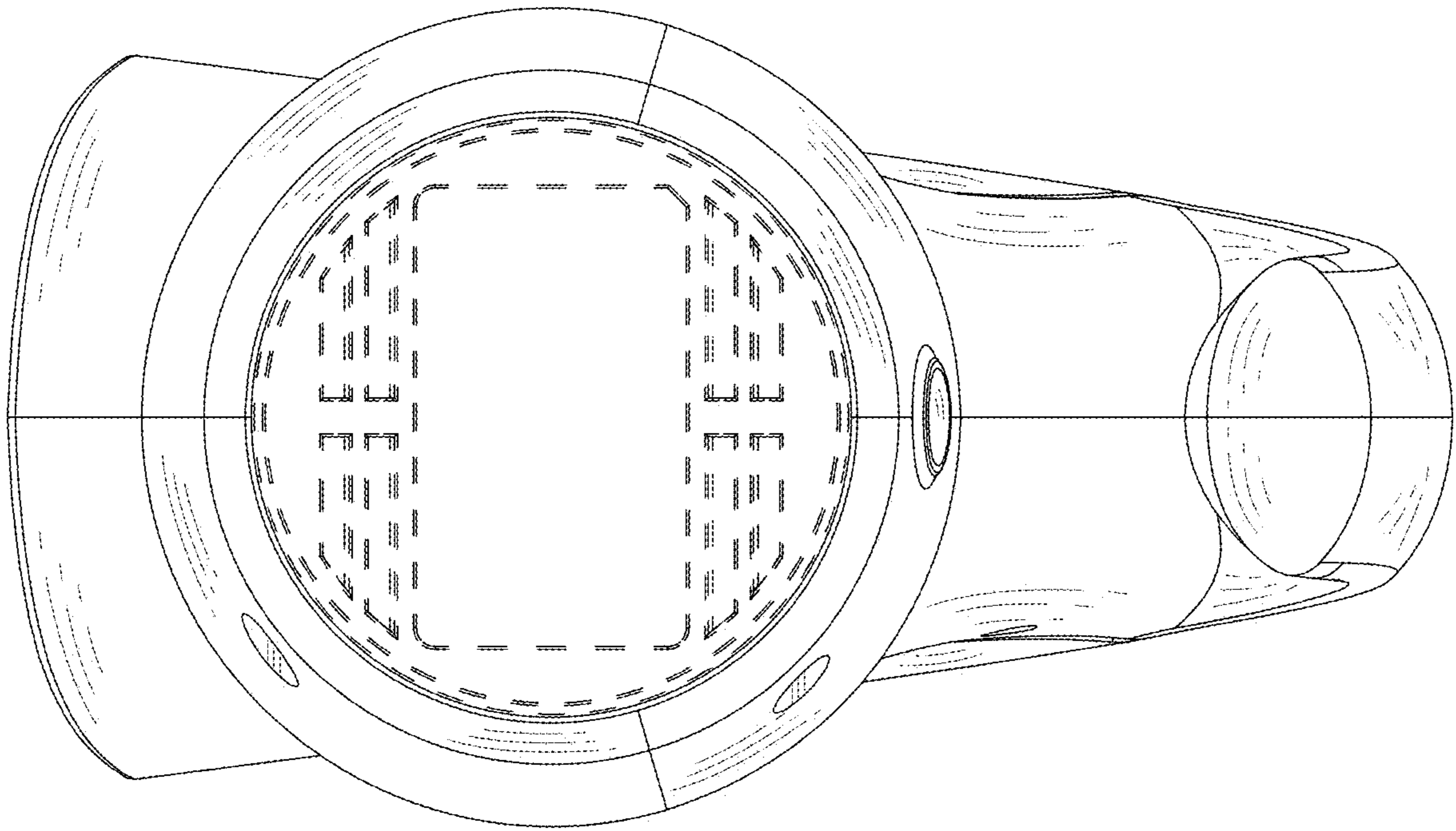

FIG. 6



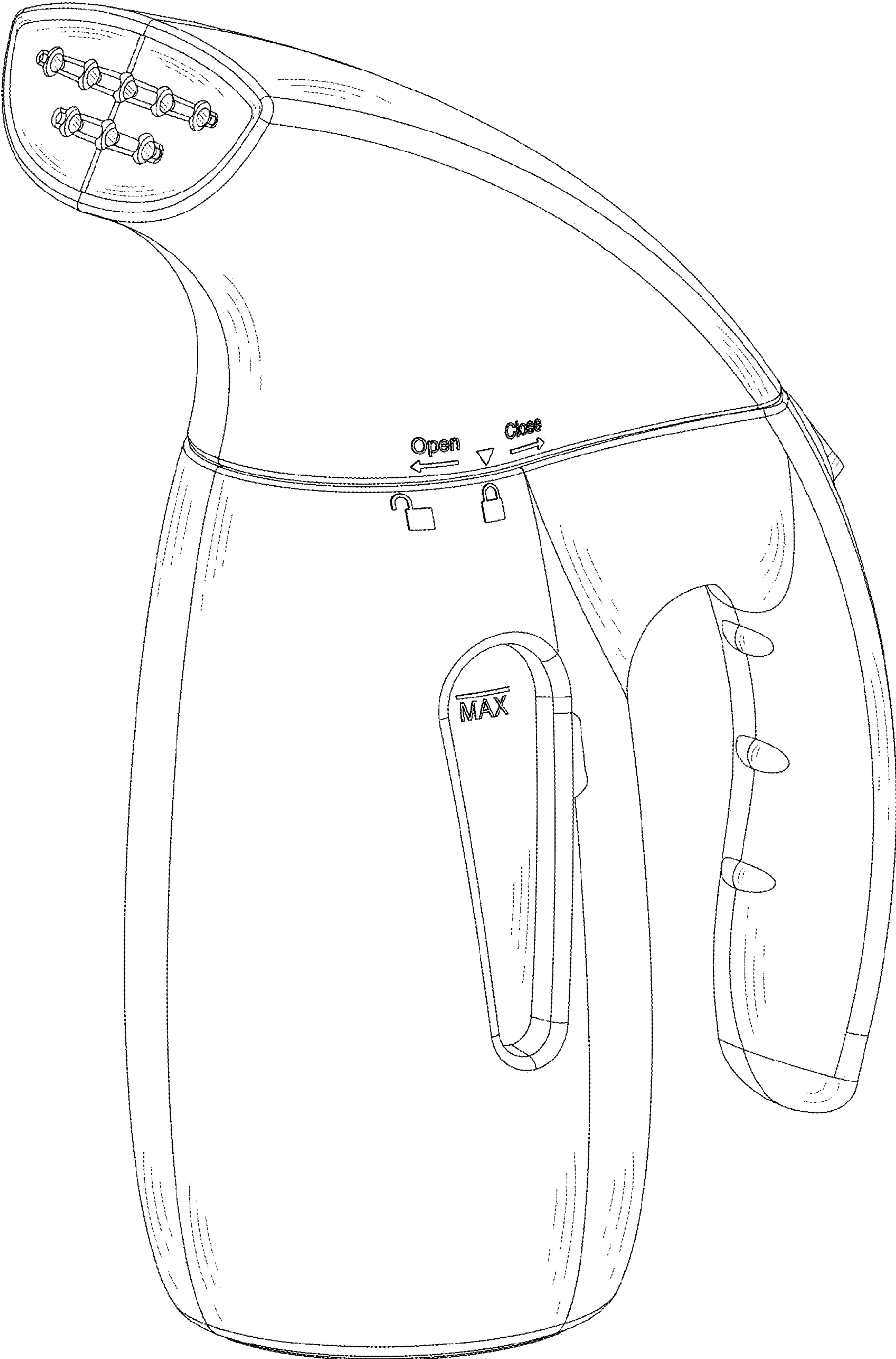

FIG. 7