



US00D920563S

(12) **United States Design Patent**
Xie et al.

(10) **Patent No.:** **US D920,563 S**

(45) **Date of Patent:** **** May 25, 2021**

(54) **LED CEILING LIGHT**

(71) Applicant: **Shenzhen Homi Lighting Co., Ltd.**,
Guangdong (CN)

(72) Inventors: **Pei-Zhu Xie**, Shenzhen (CN); **Hong Li**,
Shenzhen (CN)

(**) Term: **15 Years**

(21) Appl. No.: **29/688,466**

(22) Filed: **Apr. 22, 2019**

(30) **Foreign Application Priority Data**

Mar. 4, 2019 (CN) 201930085691.3

(51) **LOC (13) Cl.** **26-05**

(52) **U.S. Cl.**
USPC **D26/89**

(58) **Field of Classification Search**
USPC D26/24, 63, 71, 72, 74, 75-78, 80-92,
D26/118-120, 122, 131.142, 149;
D13/134; D10/111-115

CPC F21V 23/003; F21V 23/023; F21V 29/71;
F21V 29/713; F21V 29/717; F21V 29/73;
F21V 29/74; F21V 29/745; F21V 29/75;
F21V 29/76; F21V 1/02; F21V 5/00;
F21Y 2115/10; F21S 8/02; F21S 8/04;
F21S 8/026; F21S 8/033; F21S 8/036;
F21S 8/086; F21S 9/03; F21S 9/037
See application file for complete search history.

(56) **References Cited**

U.S. PATENT DOCUMENTS

D509,016 S * 8/2005 Benghozi D26/74
D509,617 S * 9/2005 Benghozi D26/74
D641,517 S * 7/2011 Sprengers D26/89
D779,106 S * 2/2017 Krueckeberg D26/89
D852,402 S * 6/2019 Zhu D26/89
D888,313 S * 6/2020 Xie D26/74

OTHER PUBLICATIONS

24102 Gunn Sal Led Oyster Light (available online Mar. 16, 2019)
Retrieved from the internet Sep. 14, 2020 from URL: https://ledlightsdownunder.com.au/products/24102-gunn-sal-led-oyster-light-sl211125cswsl-discus?_pos=5&_sid=5e9f39124&_ss=r.
SAL Discus SL2111 Dimmable Slim Led Oyster (available online)
Retrieved from the internet Sep. 14, 2020 from URL: <https://www.bestbuylighting.com.au/products/sal-discus-sl2111-dimmable-super-slim-led-oyster>[Sep. 14, 2020 2:34:48 PM].
LED Ceiling Light CL01-12-18W wall mounted Light led oyster light (available online) Retrieved from the internet Sep. 14, 2020 from URL: www.aoneled.com/LED-ceiling-light/led-ceiling-light-cl01-12-18w.html.*

* cited by examiner

Primary Examiner — Kevin K Rudzinski

Assistant Examiner — Richard Kearney

(74) *Attorney, Agent, or Firm* — Prakash Nama; Global IP Services, PLLC

(57) **CLAIM**

The ornamental design for an LED ceiling light, as shown and described.

DESCRIPTION

FIG. 1 is a front elevational view of the LED ceiling light; FIG. 2 is a rear elevational view thereof; FIG. 3 is a left side elevational view thereof; FIG. 4 is a right side elevational view thereof; FIG. 5 is a top plan view thereof; FIG. 6 is a bottom plan view thereof; and, FIG. 7 is a perspective view projecting toward the rear thereof.

The broken lines illustrate portions of the LED ceiling light that form no part of the claimed design.

1 Claim, 7 Drawing Sheets

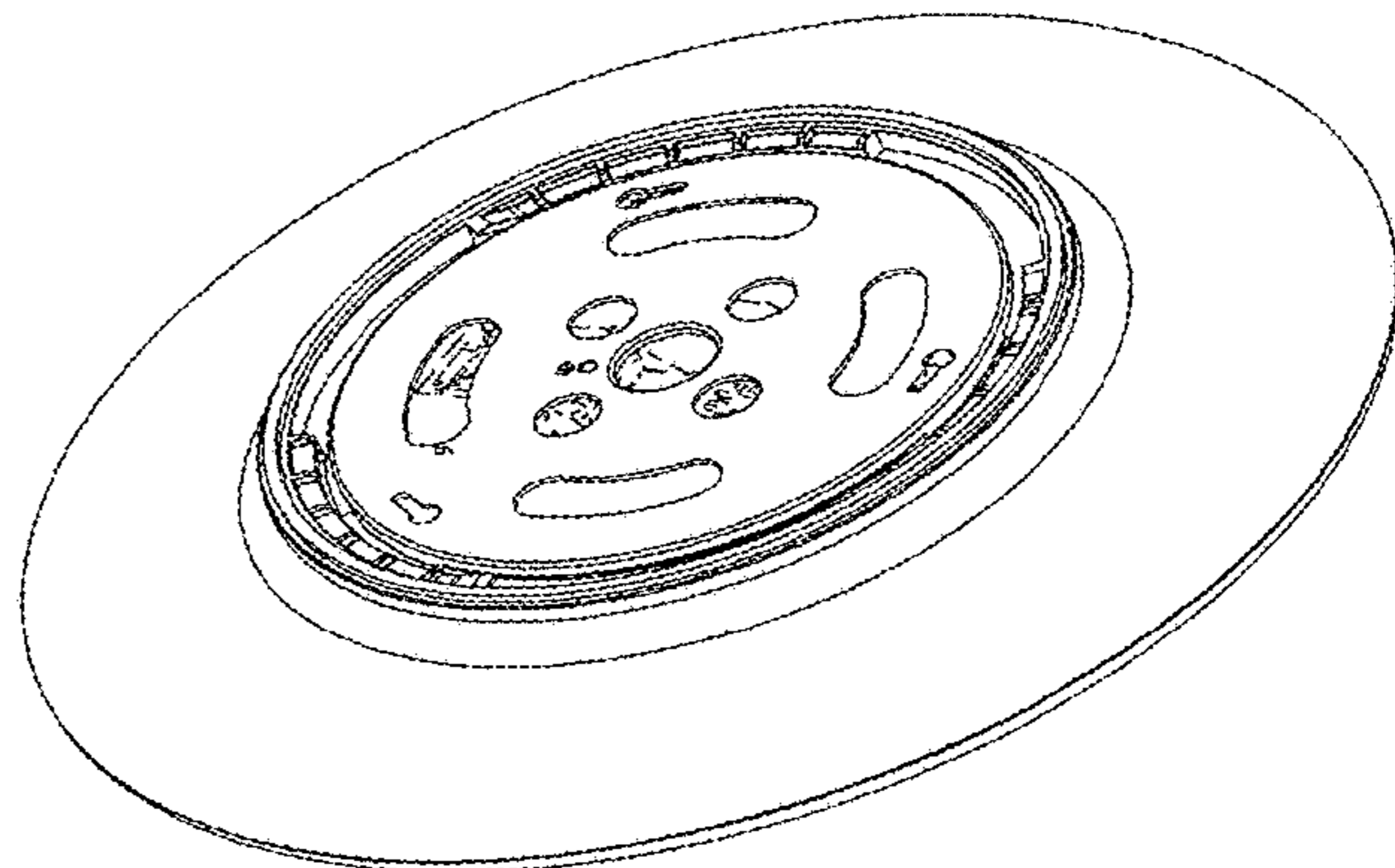
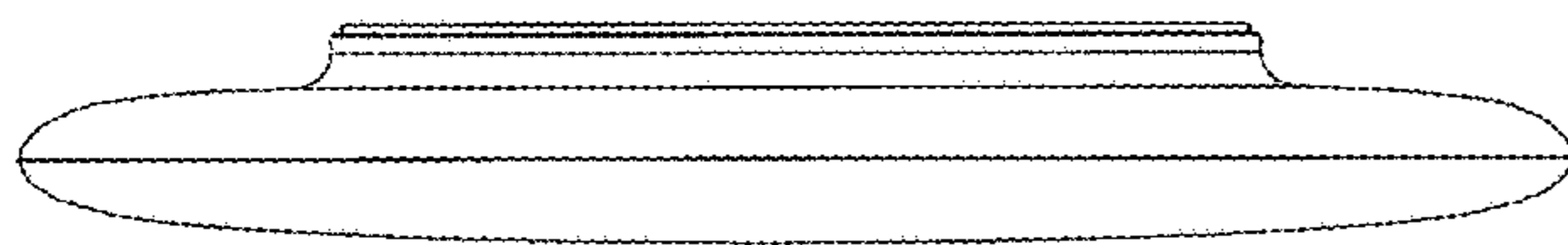

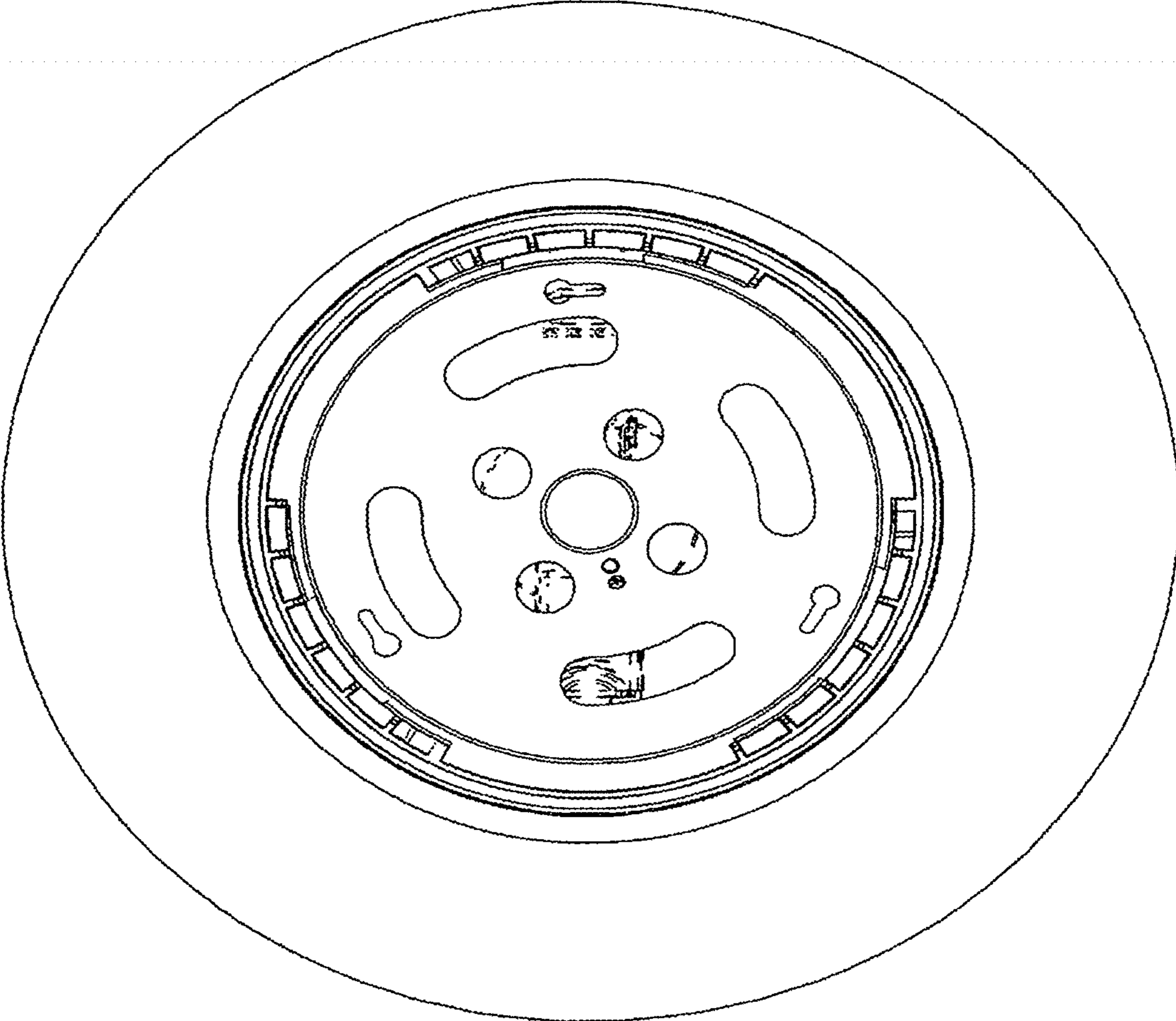

FIG. 1

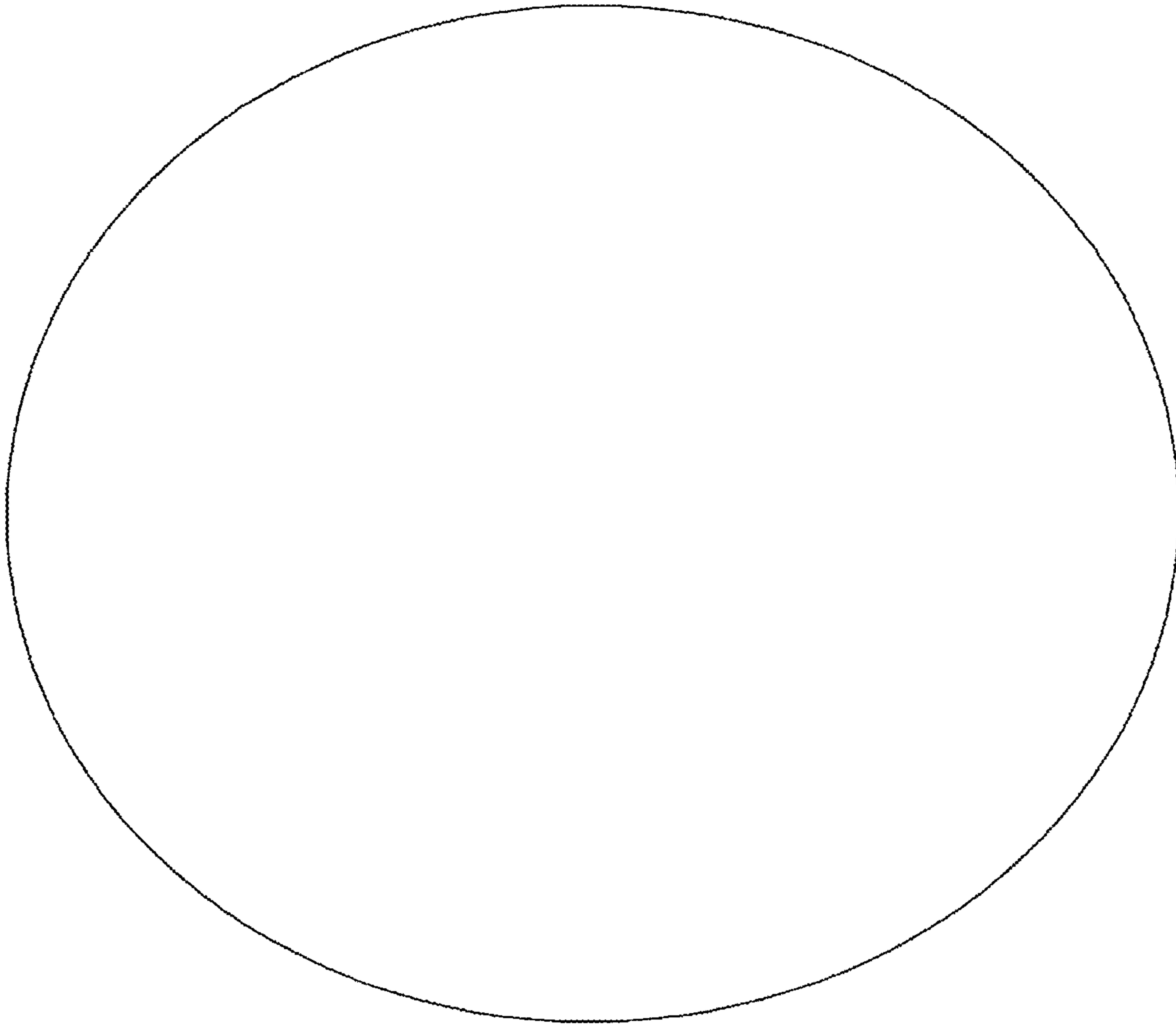

FIG. 2

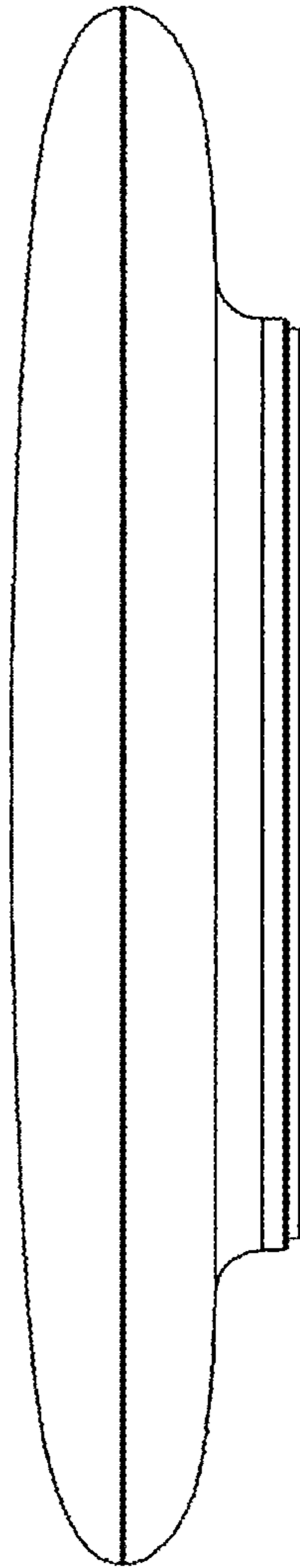

FIG. 3

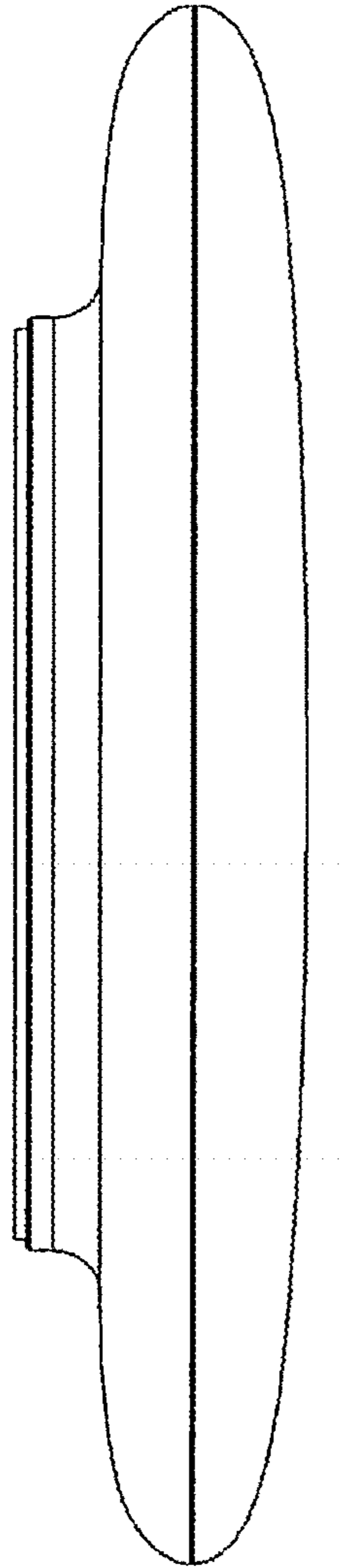

FIG. 4

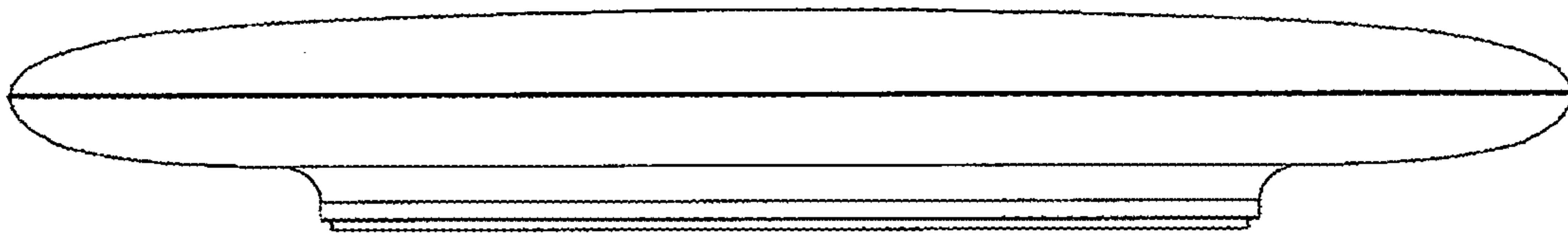

FIG. 5

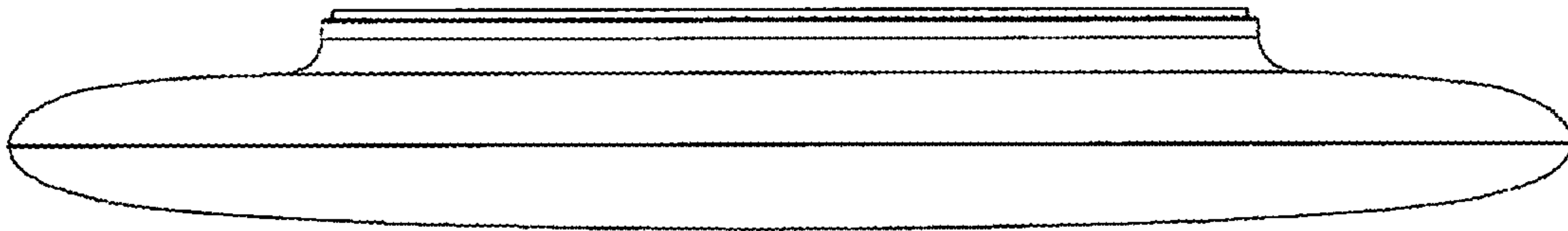

FIG. 6

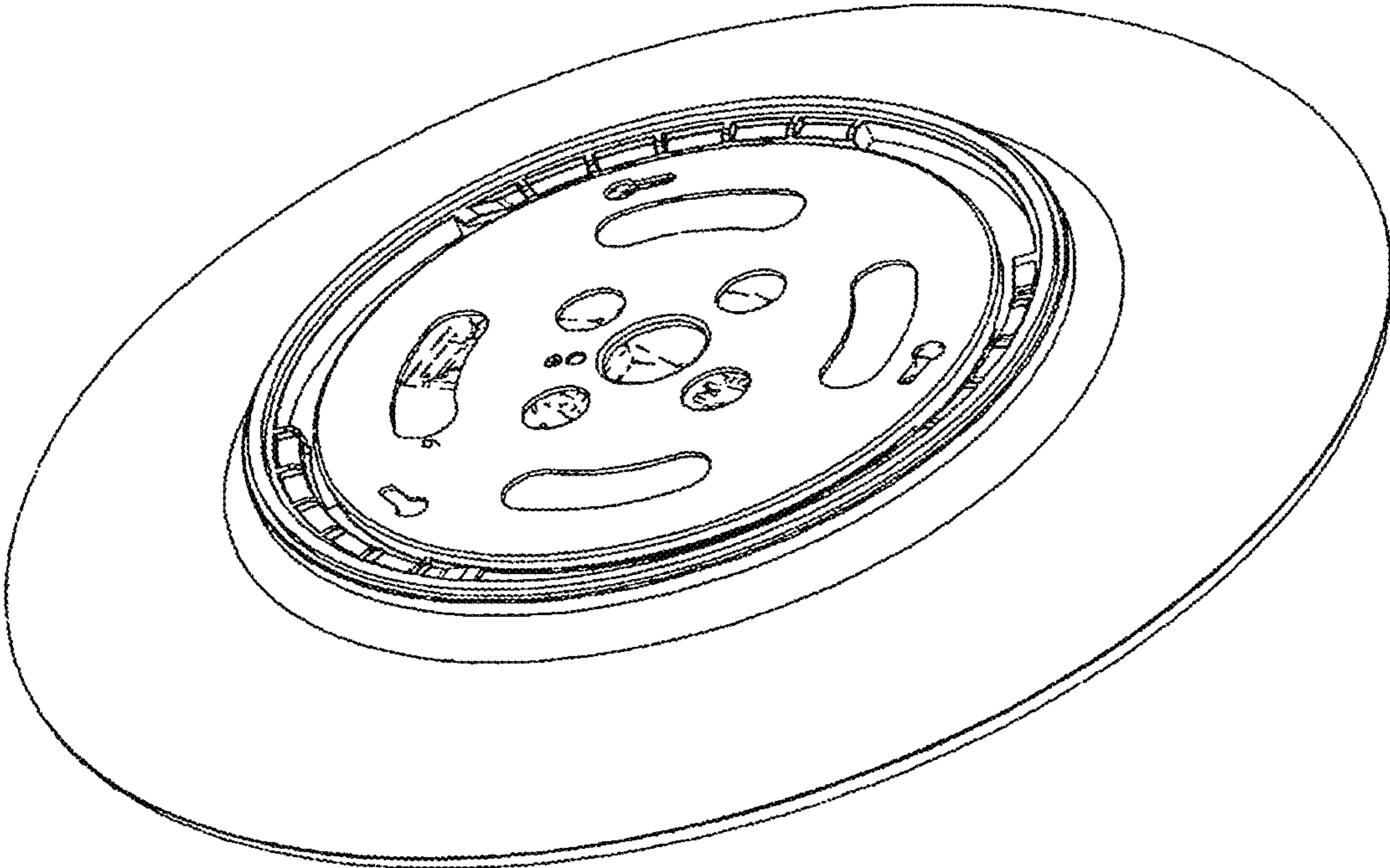

FIG. 7