



US00D920530S

(12) **United States Design Patent** (10) **Patent No.:** **US D920,530 S**
Sedic (45) **Date of Patent:** **** May 25, 2021**

(54) **PERSONAL MASSAGER**
(71) Applicant: **Filip Sedic**, Stockholm (SE)
(72) Inventor: **Filip Sedic**, Stockholm (SE)
(73) Assignee: **LELO Inc.**, San Jose, CA (US)
(**) Term: **15 Years**
(21) Appl. No.: **29/706,282**
(22) Filed: **Sep. 19, 2019**
(51) **LOC (13) Cl.** **28-03**
(52) **U.S. Cl.**
USPC **D24/215**
(58) **Field of Classification Search**
USPC D24/200, 211, 212, 213, 214, 215
CPC .. A61H 19/32; A61H 19/40; A61H 2205/087;
A61H 19/34; A61H 21/00; A61H
2201/1652
See application file for complete search history.

(56) **References Cited**
U.S. PATENT DOCUMENTS
D605,779 S * 12/2009 Murison D24/215
D652,942 S * 1/2012 Murison D24/215
D653,349 S * 1/2012 Chong D24/215
D665,092 S * 8/2012 Sedic D24/215
D665,094 S * 8/2012 Sedic D24/215
D681,219 S * 4/2013 Chen D24/215
D681,224 S * 4/2013 Chen D24/215
D681,225 S * 4/2013 Chen D24/215
D685,917 S * 7/2013 Chen D24/215
D685,918 S * 7/2013 Chen D24/215
D688,381 S * 8/2013 Marshall D24/215
D693,935 S * 11/2013 Chen D24/215
D693,936 S * 11/2013 Chen D24/215
D697,631 S * 1/2014 Marshall D24/215
D700,347 S * 2/2014 Sedic D24/215
D702,363 S * 4/2014 Tai D24/215

D712,054 S * 8/2014 Tai A61H 19/40
D24/215
D712,059 S * 8/2014 Sedic D24/215
D727,524 S * 4/2015 Qian D24/215
D727,525 S * 4/2015 Qian D24/215
D732,683 S * 6/2015 Zhang D24/215
D739,547 S * 9/2015 Cheung D24/215
D739,548 S * 9/2015 Cheung D24/215
D739,951 S * 9/2015 Tai D24/215
D743,570 S * 11/2015 Cheung D24/215
D761,429 S * 7/2016 Sedic D24/141
D764,056 S * 8/2016 Sedic D24/141
D771,828 S * 11/2016 Sedic D24/215
D771,830 S * 11/2016 Sedic D24/215
D772,422 S * 11/2016 Sedic D24/215
D796,055 S * 8/2017 Chen D24/215
D802,761 S * 11/2017 Sedic D24/141
9,889,064 B1 * 2/2018 Olivares A61H 23/02
D817,507 S * 5/2018 Cheung D24/215
D818,143 S * 5/2018 Cheung D24/215

(Continued)

Primary Examiner — Cynthia Ramirez
Assistant Examiner — Michael A Maharajh
(74) *Attorney, Agent, or Firm* — Evan Feldstein

(57) **CLAIM**
I claim the ornamental design for a personal massager, as shown and described.

DESCRIPTION
FIG. 1 is a perspective view of a personal massager.
FIG. 2 is a left side view of the personal massager.
FIG. 3 is a right side view of the personal massager.
FIG. 4 is a rear view of the personal massager.
FIG. 5 is a front view of the personal massager.
FIG. 6 is a bottom view of the personal massager; and,
FIG. 7 is a top view of the personal massager.
The broken lines are directed to environment and are for illustrative purposes only; the broken lines form no part of the claimed design.

1 Claim, 7 Drawing Sheets

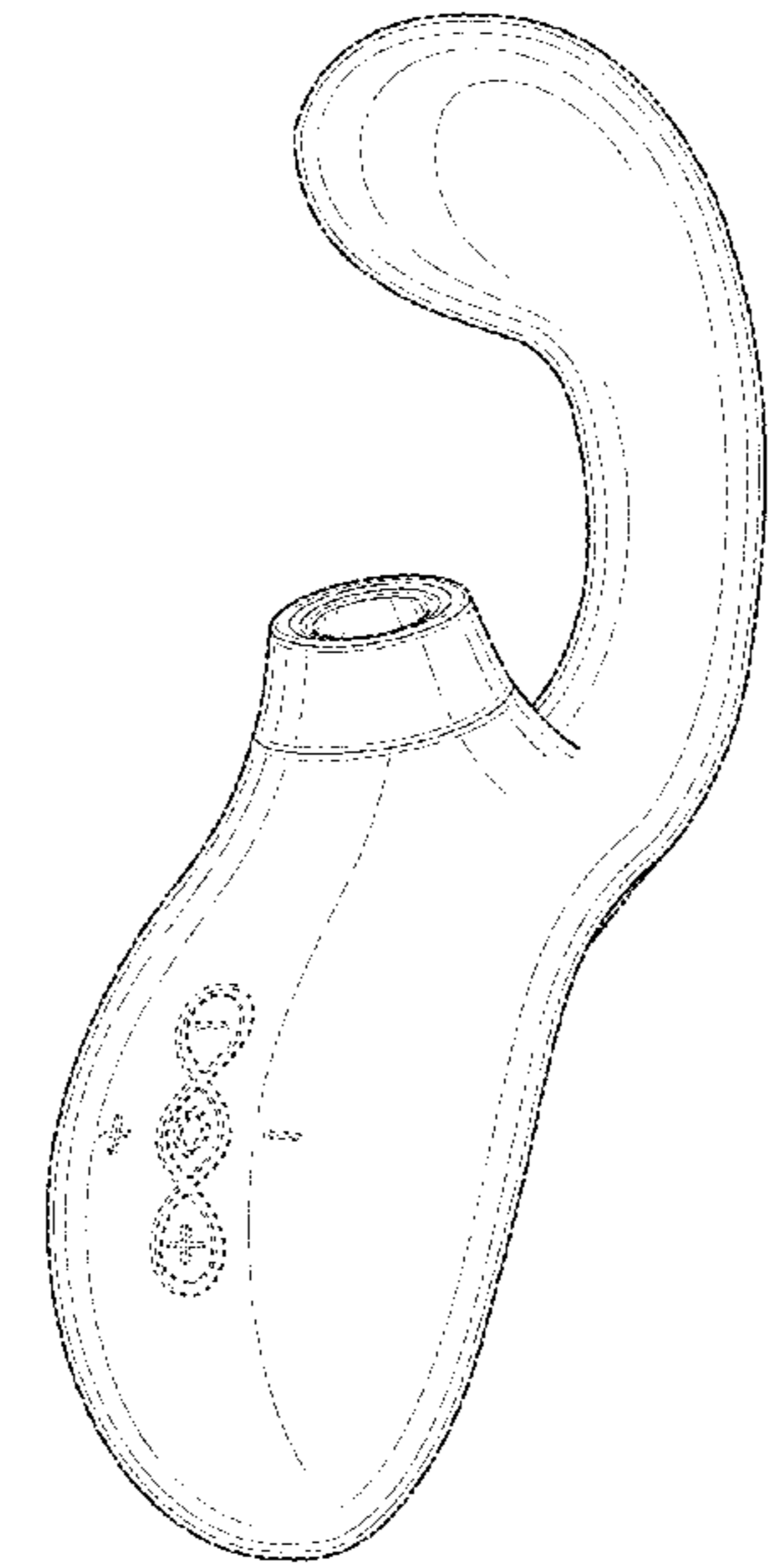

(56)

References Cited

U.S. PATENT DOCUMENTS

D818,144	S *	5/2018	Cheung	D24/215
D827,135	S *	8/2018	Sedic	D24/141
D829,922	S *	10/2018	Sedic	D24/215
D854,179	S *	7/2019	Cheung	D24/215
D854,181	S *	7/2019	Wei	D24/215
D854,702	S *	7/2019	Cheung	D24/215
D877,352	S *	3/2020	Jouffret	D24/215
D879,990	S *	3/2020	Qiu	D24/215
D879,992	S *	3/2020	Li	D24/215
D882,806	S *	4/2020	Takashima	D24/214
D884,206	S *	5/2020	Haddock	D24/215
D884,914	S *	5/2020	Gao	D24/215
D898,912	S *	10/2020	Xie	D24/141
D898,937	S *	10/2020	Haddock	D24/215
2013/0331745	A1 *	12/2013	Sedic	A61H 19/44 601/46
2015/0231024	A1 *	8/2015	Sedic	A61H 23/0263 600/38
2018/0140504	A1 *	5/2018	Chang	A61H 99/00
2018/0185237	A1 *	7/2018	Baetica	G08C 17/02

* cited by examiner

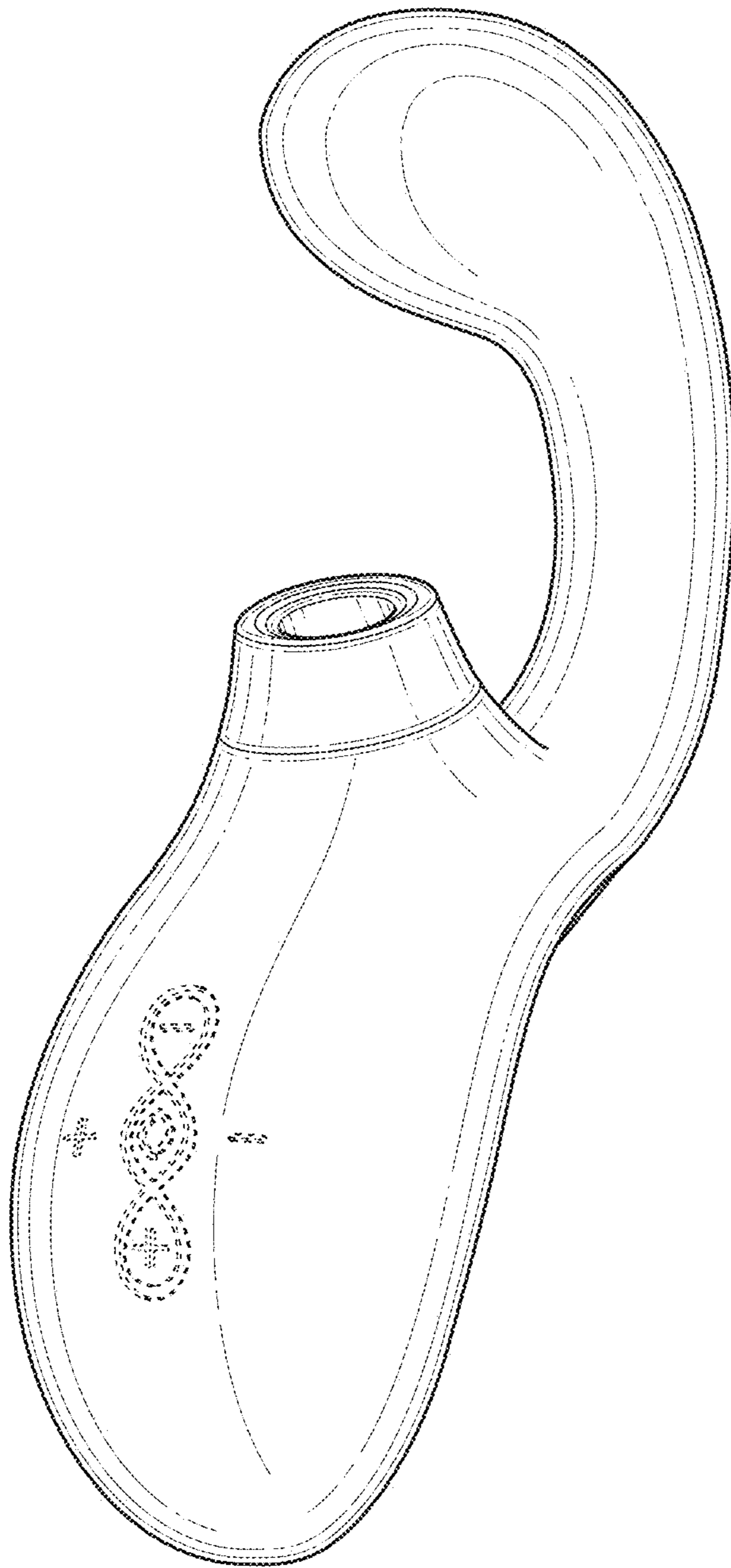

FIG. 1

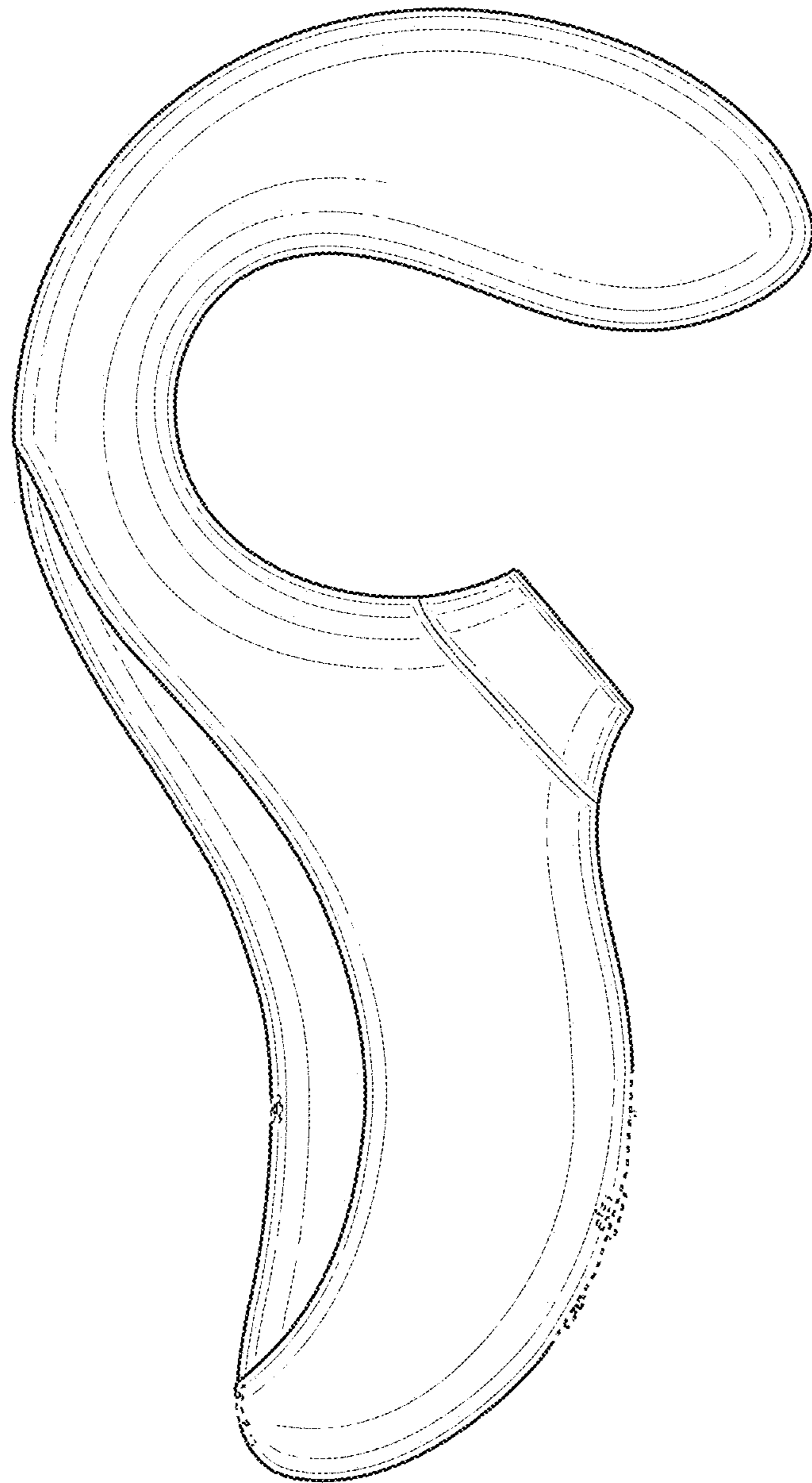

FIG. 2

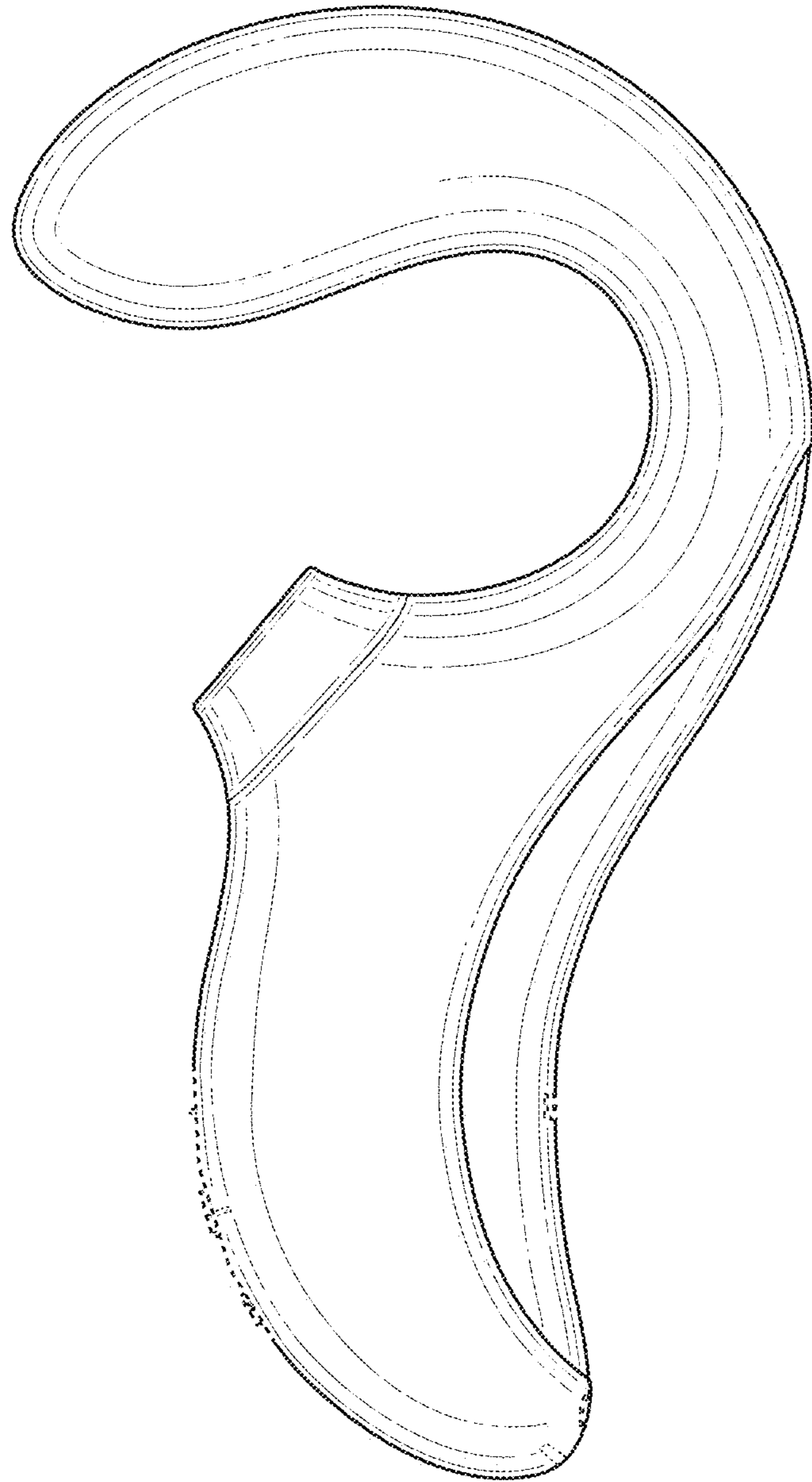

FIG. 3

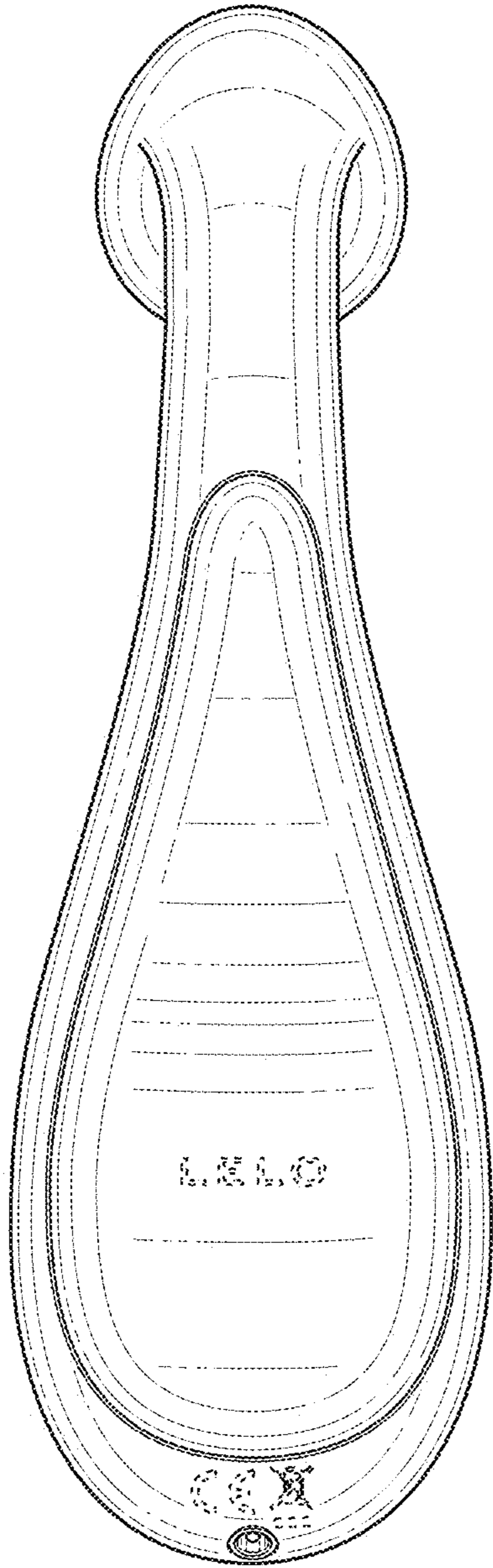

FIG. 4

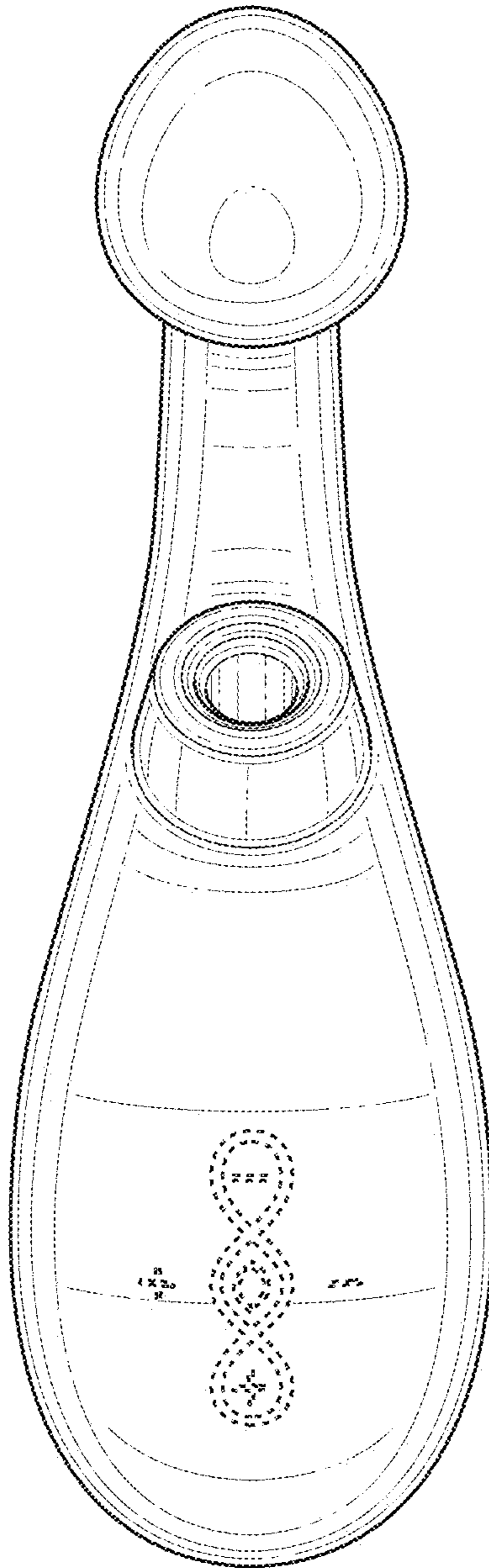

FIG. 5

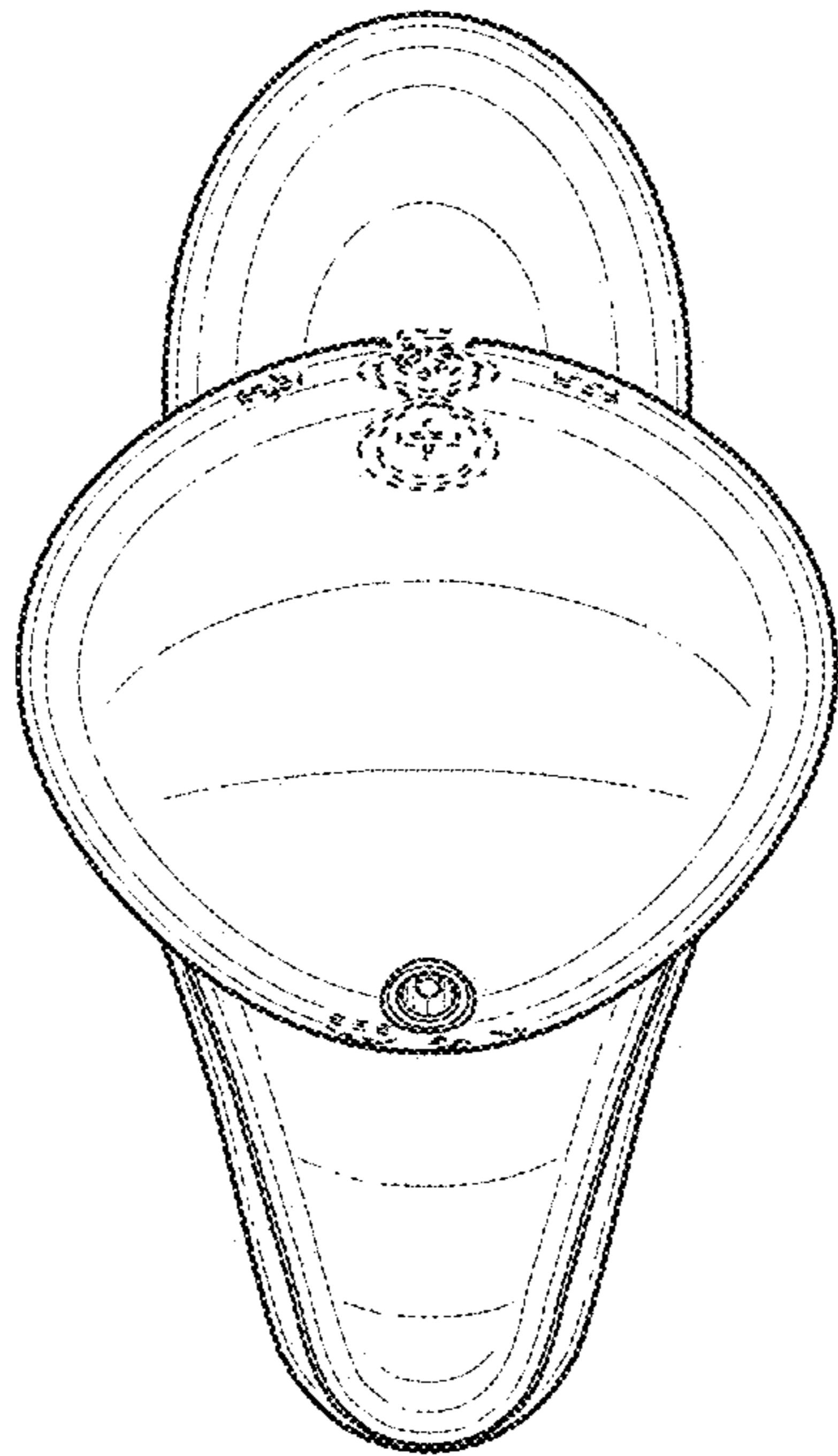

FIG. 6

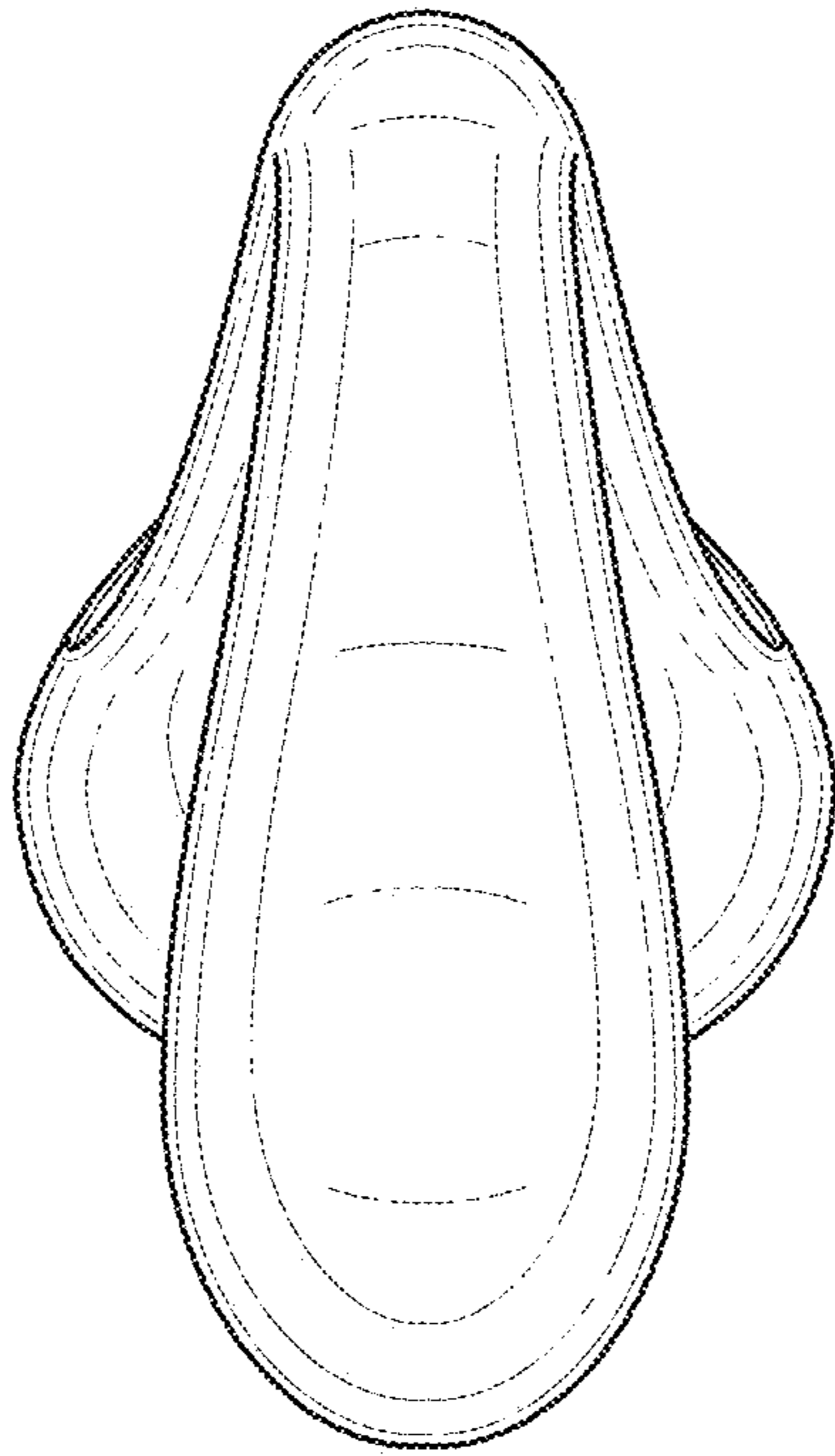

FIG. 7