



US00D920466S

(12) **United States Design Patent** (10) **Patent No.:** **US D920,466 S**
Hamnvik (45) **Date of Patent:** **** May 25, 2021**

(54) **GAS CONTAINER** 7,255,245 B2 * 8/2007 Oliveira F17C 1/04
 220/586
 (71) Applicant: **Hexagon Ragasco AS**, Raufoss (NO) 7,699,188 B2 * 4/2010 Oliveira F17C 13/084
 220/586
 (72) Inventor: **Per Vidar Hamnvik**, Gjøvik (NO) 7,735,506 B2 * 6/2010 Horton, III B65D 88/78
 137/1
 (73) Assignee: **Hexagon Ragasco AS**, Raufoss (NO) D621,471 S * 8/2010 Bock D23/202
 8,162,167 B2 * 4/2012 Da Silva F17C 3/08
 220/560.04
 (**) Term: **15 Years** D666,691 S * 9/2012 Higgins D23/202
 D701,286 S * 3/2014 Sandvoid D23/202
 (21) Appl. No.: **35/507,801** D728,732 S * 5/2015 Higgins D23/202
 D759,785 S * 6/2016 Hamnvik D23/202
 (22) Filed: **Mar. 26, 2019** D812,186 S * 3/2018 Aguiar D23/206
 D827,764 S * 9/2018 Mangeot-Gehin D23/202
 (80) **Hague Agreement Data** D845,435 S * 4/2019 Pedrosa D23/225
 D890,294 S * 7/2020 De Biasi D23/207
 Int. Filing Date: **Mar. 26, 2019**
 Int. Reg. No.: **DM/203873**
 Int. Reg. Date: **Mar. 26, 2019**
 Int. Reg. Pub. Date: **Nov. 15, 2019**

* cited by examiner

Primary Examiner — Richard E Chilcot
(74) *Attorney, Agent, or Firm* — Christian D. Abel

(30) **Foreign Application Priority Data**
 Sep. 27, 2018 (NO) 20180854
 (51) **LOC (13) Cl.** **23-01**
 (52) **U.S. Cl.**
 USPC **D23/202**
 CPC **F17C 13/06** (2013.01)
 (58) **Field of Classification Search**
 USPC D23/200, 202–207, 211.1–211.2, 213
 CPC F17C 13/06; F17C 13/123; F17C 1/00;
 F17C 1/005; F17C 2223/0123; F17C
 2223/035; F17C 2223/036; F02M
 37/0076; Y10S 220/901; Y10S 220/905
 See application file for complete search history.

(56) **References Cited**
 U.S. PATENT DOCUMENTS
 D337,367 S * 7/1993 McKenzie D23/202
 6,386,384 B1 * 5/2002 Chohfi F17C 13/06
 206/0.6

(57) **CLAIM**
 The ornamental design for a gas container, as shown and described.

DESCRIPTION
 1. Gas container
 1.1 : Perspective from above
 1.2 : Top
 1.3 : Left
 1.4 : Front
 1.5 : Right
 1.6 : Back
 1.7 : Bottom
 1.8 : Perspective from below

1 Claim, 8 Drawing Sheets

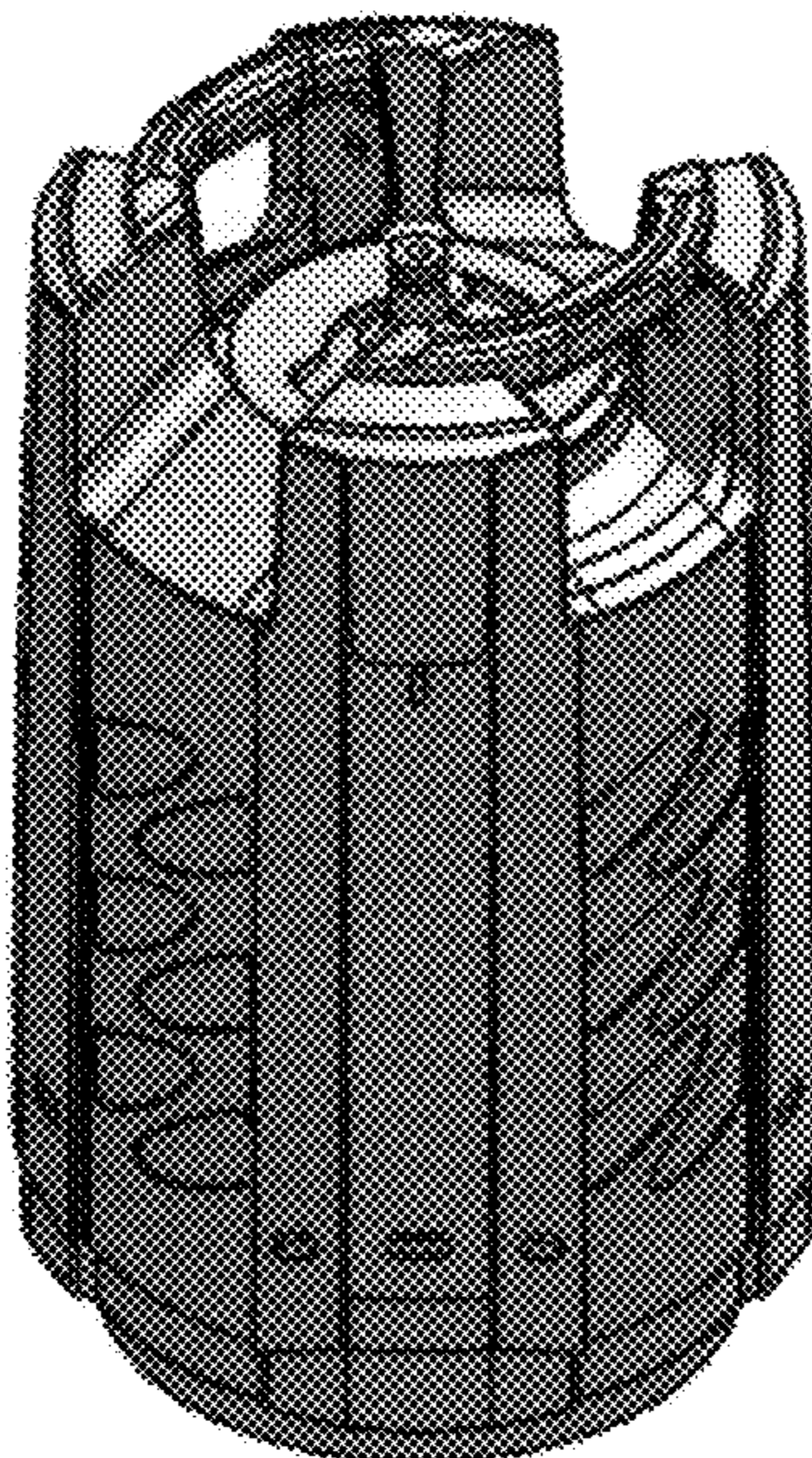

1.1

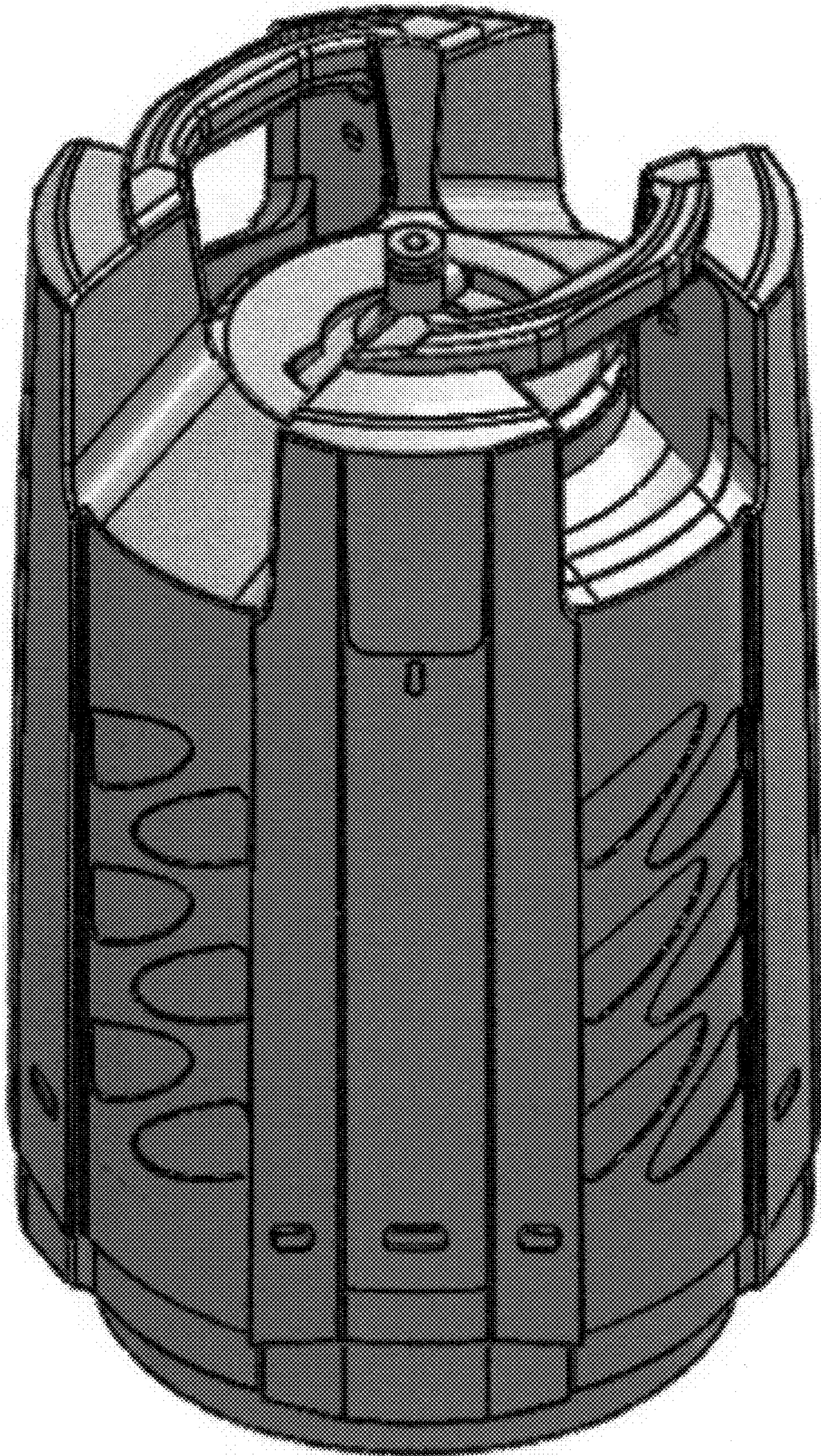

1.2

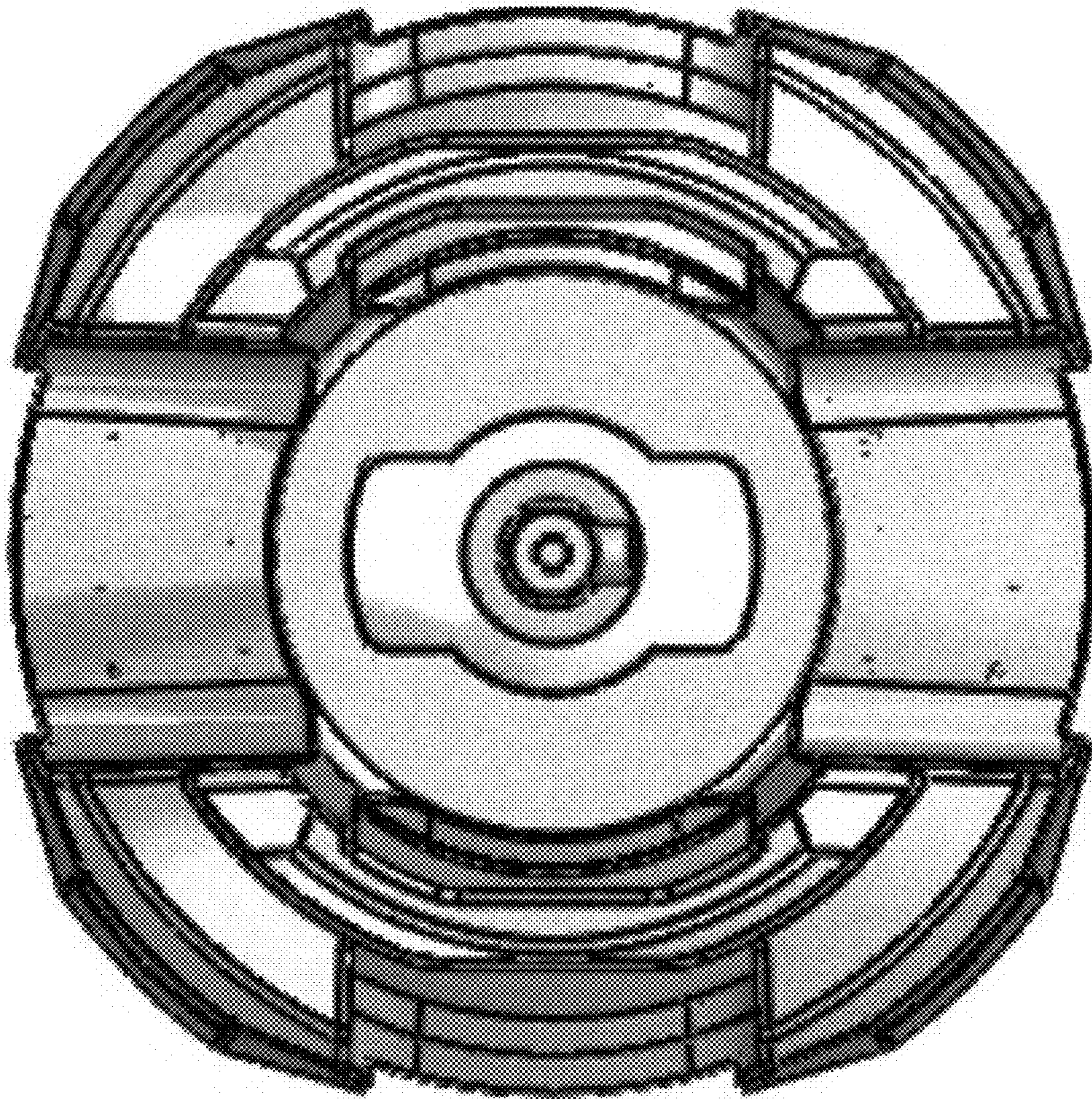

1.3

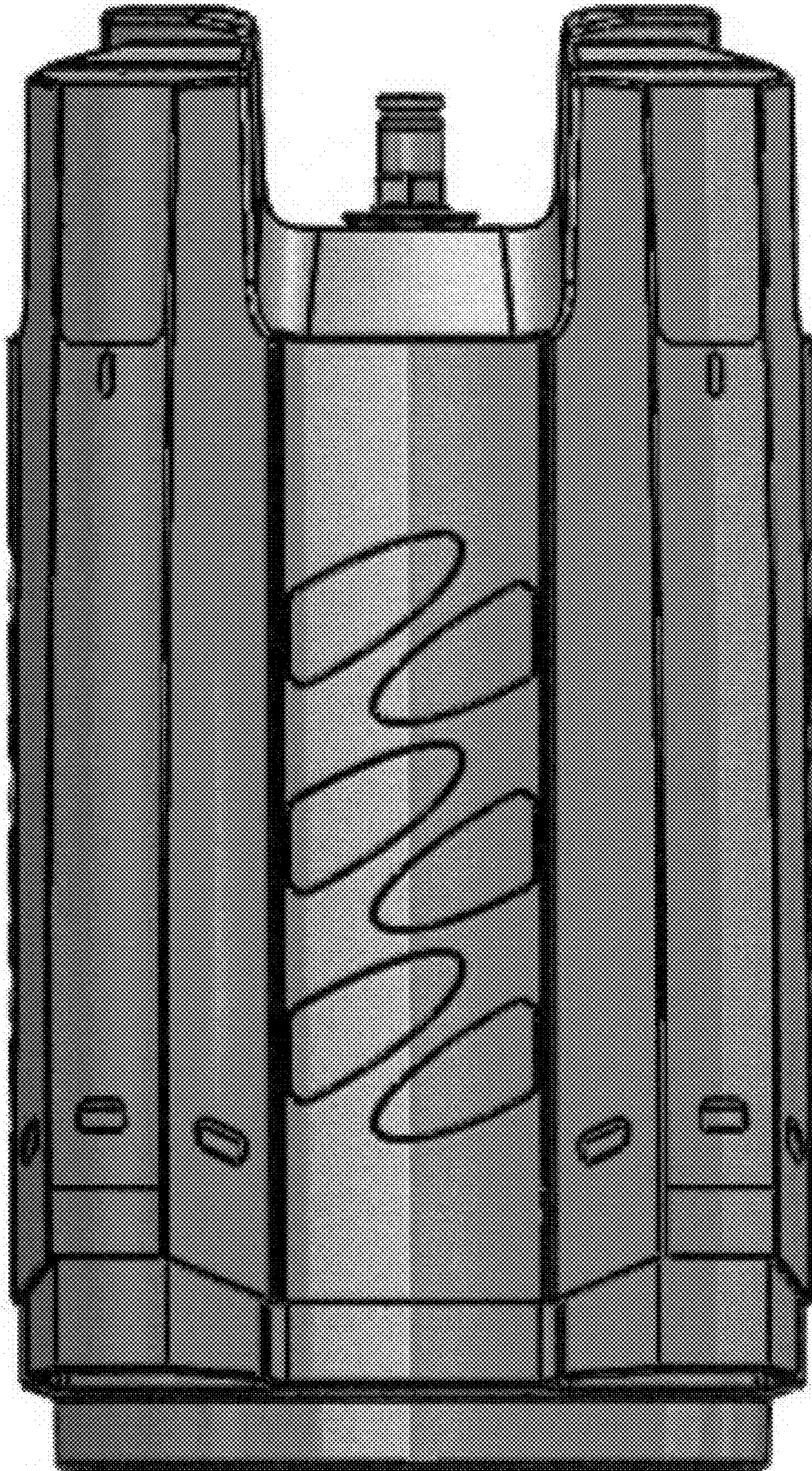

1.4

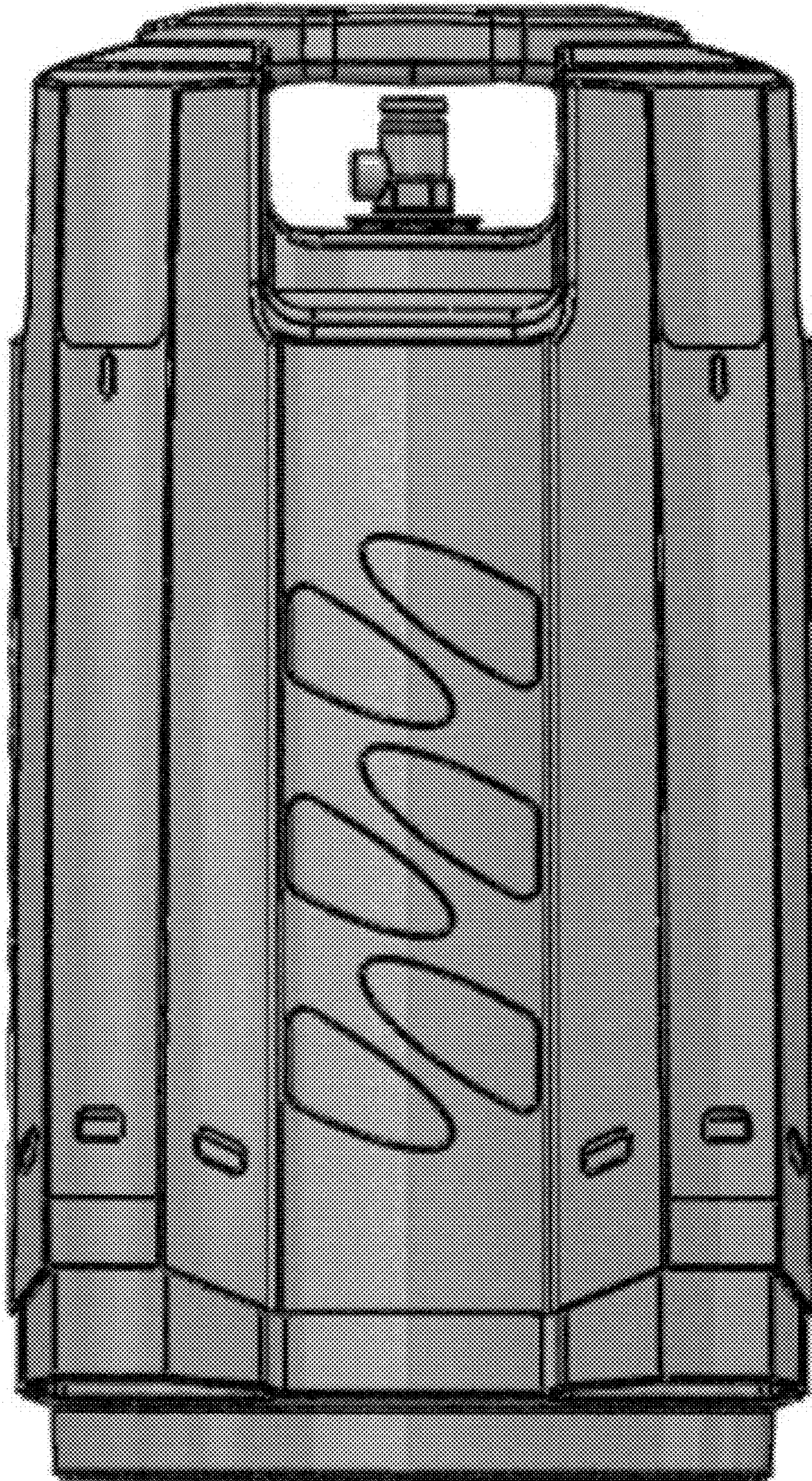

1.5

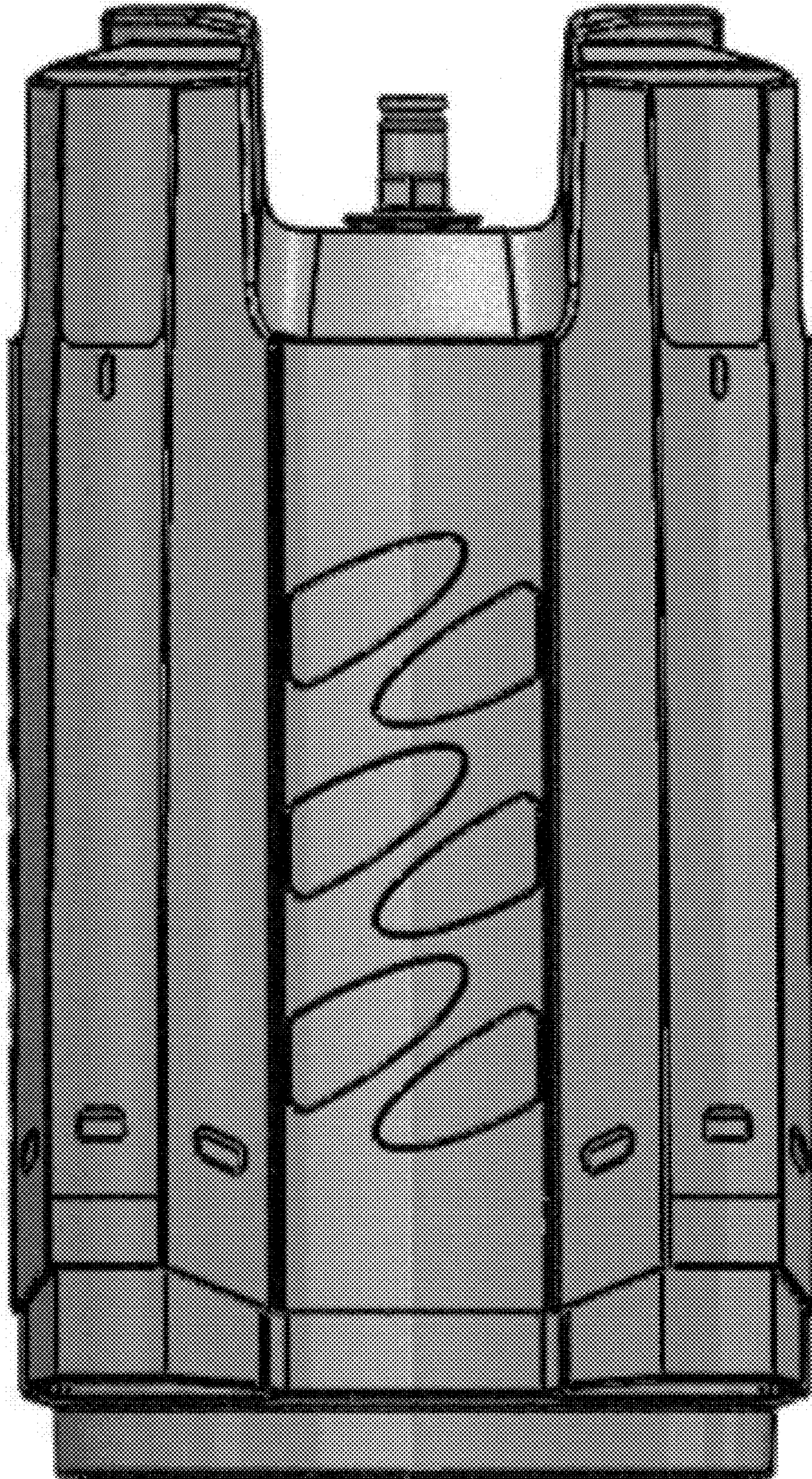

1.6

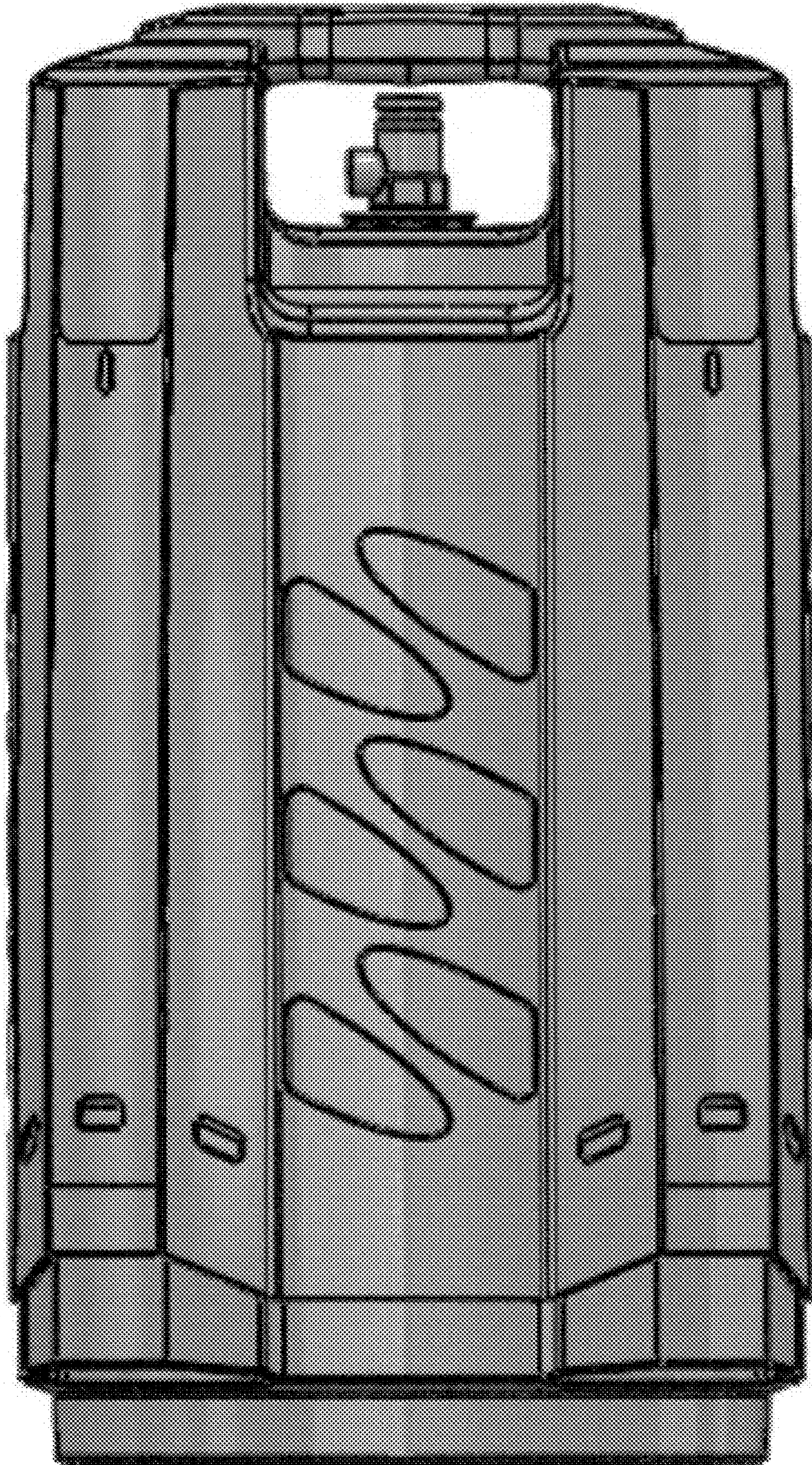

1.7



1.8

