



US00D920452S

(12) **United States Design Patent**  
**Parsons et al.**

(10) **Patent No.:** **US D920,452 S**

(45) **Date of Patent:** **\*\* May 25, 2021**

(54) **GOLF CLUB HEAD**

(71) Applicant: **PARSONS XTREME GOLF, LLC**,  
Scottsdale, AZ (US)

(72) Inventors: **Robert R. Parsons**, Scottsdale, AZ  
(US); **Michael R. Nicolette**, Scottsdale,  
AZ (US)

(73) Assignee: **PARSONS XTREME GOLF, LLC**,  
Scottsdale, AZ (US)

(\*\*) Term: **15 Years**

(21) Appl. No.: **29/703,623**

(22) Filed: **Aug. 28, 2019**

**Related U.S. Application Data**

(63) Continuation-in-part of application No. 29/693,326,  
filed on May 31, 2019, now abandoned.

(51) **LOC (13) Cl.** ..... **21-02**

(52) **U.S. Cl.**  
USPC ..... **D21/736**

(58) **Field of Classification Search**  
USPC ..... D21/736-746, 759  
CPC ..... A63B 53/00; A63B 53/04; A63B 53/007;  
A63B 53/065; A63B 53/0487; A63B  
60/00; A63B 60/46

See application file for complete search history.

(56) **References Cited**

**U.S. PATENT DOCUMENTS**

723,534 A	3/1903	Knight
922,444 A	5/1909	Youds
RE19,178 E	5/1934	Spiker
4,043,562 A	8/1977	Shillington
4,340,230 A	7/1982	Churchward
4,754,977 A	7/1988	Sahm
4,869,507 A	9/1989	Sahm
4,964,641 A	10/1990	Miesch
D335,317 S	5/1993	Shearer
D335,692 S	5/1993	Antonious
D336,757 S	6/1993	Antonious

5,275,412 A	1/1994	Innes	
D350,582 S	9/1994	Miansian et al.	
D359,330 S	* 6/1995	Channell	D21/741
5,429,366 A	7/1995	McCabe	
D363,101 S	10/1995	Sturm	
5,489,097 A	2/1996	Simmons	
D368,751 S	4/1996	Rife	
D369,393 S	4/1996	Oku	
D365,864 S	10/1996	Strum	
5,571,053 A	11/1996	Lane	
D378,688 S	4/1997	Cameron, Jr.	
D381,382 S	* 7/1997	Fenton, Jr.	D21/743
D385,609 S	10/1997	Cameron	
5,683,307 A	11/1997	Rife	
D388,143 S	12/1997	Huan-Chiang	
D389,207 S	1/1998	Cameron	
D398,685 S	9/1998	Masuda	
D399,274 S	* 10/1998	Bradford	D21/736
D399,290 S	10/1998	Sizemore, Jr.	
D399,911 S	10/1998	Sanchez	
5,839,974 A	11/1998	McAllister	
D405,836 S	2/1999	Nicolette et al.	
D409,701 S	5/1999	Ashcraft et al.	
5,924,938 A	7/1999	Hines	
6,007,434 A	12/1999	Baker	
D422,041 S	* 3/2000	Bradford	D21/736
D422,655 S	4/2000	Hicks	
6,050,903 A	4/2000	Lake	
D426,276 S	6/2000	Besnard et al.	
D431,854 S	10/2000	Cameron	
D432,192 S	10/2000	Hicks	
D436,151 S	1/2001	Nicolette et al.	
D437,374 S	2/2001	Cameron	
D441,820 S	5/2001	Nicolette et al.	
D443,668 S	6/2001	Nicolette et al.	
D443,905 S	6/2001	Nicolette et al.	
D444,833 S	7/2001	Nicolette	
6,257,994 B1	7/2001	Antonious	
6,264,571 B1	7/2001	Lekavich	
D449,664 S	10/2001	Beebe et al.	
D449,865 S	10/2001	Fife, Jr. et al.	
D450,799 S	11/2001	Nicolette et al.	
D451,973 S	12/2001	Wells et al.	
6,348,014 B1	2/2002	Chiu	
6,354,959 B1	3/2002	Nicolette	
6,394,910 B1	5/2002	McCarthy	
D472,949 S	4/2003	Serrano	
D474,821 S	5/2003	Weft et al.	
D474,949 S	5/2003	Schaffeld et al.	
6,652,390 B2	* 11/2003	Bradford	A63B 60/02 473/341
D483,086 S	12/2003	Schweigert	
D486,872 S	2/2004	Schweigert et al.	

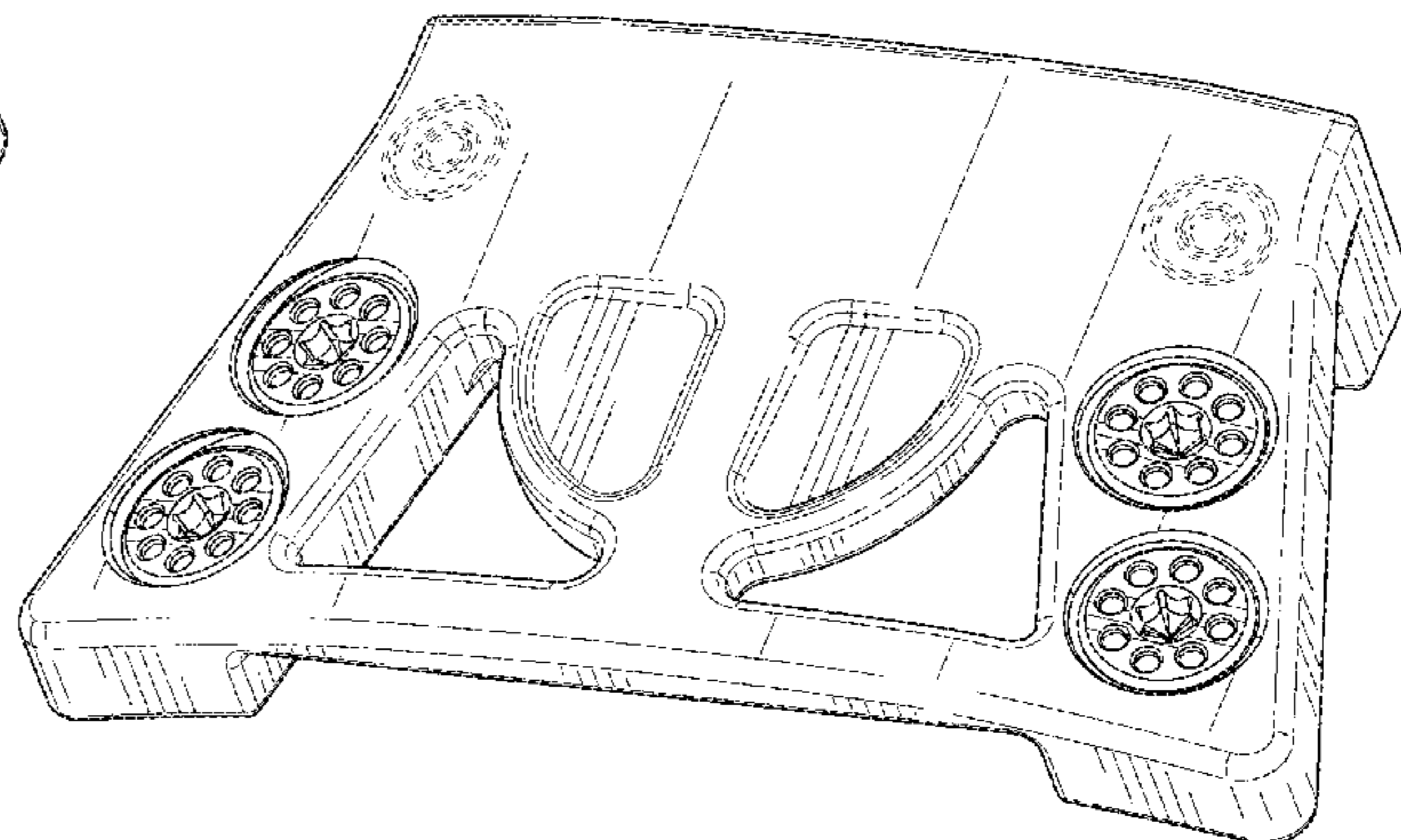
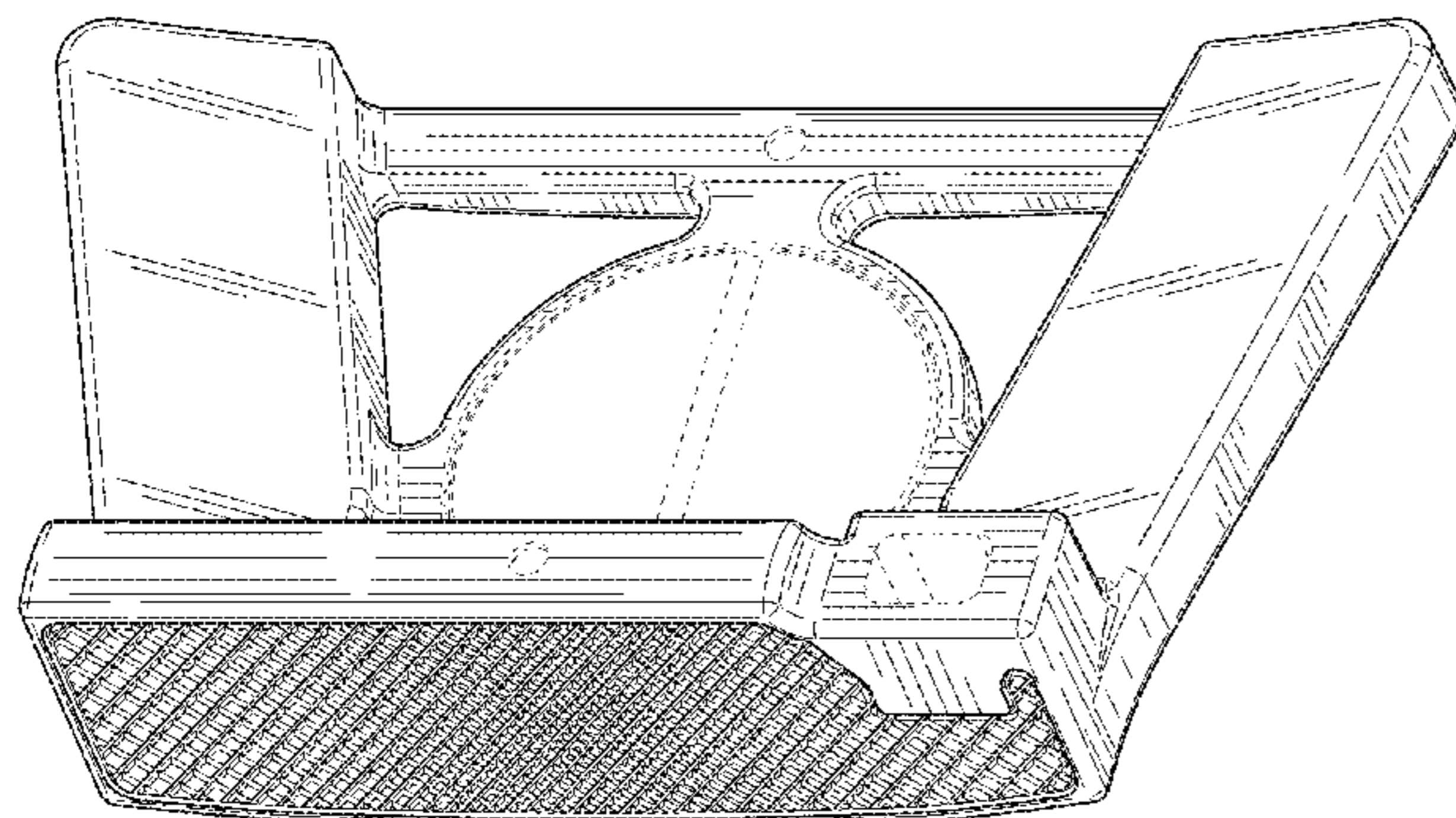



# US D920,452 S

D488,200 S	4/2004	Morgulis		D715,388 S	10/2014	Serrano
D498,276 S	11/2004	Schweigert et al.		8,900,064 B2 *	12/2014	Franklin ..... A63B 53/0487 473/251
6,902,496 B2	6/2005	Solheim		D722,350 S	2/2015	Schweigert
D512,116 S	11/2005	Miraflor et al.		D722,351 S	2/2015	Parsons et al.
6,988,955 B2	1/2006	Stoakes		D722,352 S	2/2015	Nicolette et al.
6,988,956 B2	1/2006	Cover		D723,120 S	2/2015	Nicolette
D520,083 S	5/2006	Parr		D724,164 S	3/2015	Schweigert et al.
D520,584 S *	5/2006	Karlsen .....	D21/743	D725,208 S	3/2015	Schweigert
D531,242 S	10/2006	Adams		D726,265 S	4/2015	Nicolette
7,125,341 B1	10/2006	D Eath		D726,270 S *	4/2015	Rollinson ..... D21/759
D532,067 S	11/2006	Soracco		D726,846 S	4/2015	Schweigert
7,153,220 B2	12/2006	Lo		D730,462 S	5/2015	Becktor
D534,595 S	1/2007	Hasebe		D732,122 S	6/2015	Becktor
7,156,752 B1	1/2007	Bennett		D732,618 S	6/2015	Nivanh
D536,401 S	2/2007	Kawami		D733,234 S	6/2015	Nicolette
D536,403 S	2/2007	Kawami		D738,447 S	9/2015	Schweigert
D538,371 S	3/2007	Kawami		D738,449 S	9/2015	Schweigert
7,204,765 B2	4/2007	Cover		D739,487 S	9/2015	Schweigert
D542,869 S	5/2007	Adams		9,144,717 B2 *	9/2015	Franklin ..... A63B 53/007
D542,873 S *	5/2007	Oldknow .....	D21/759	D741,426 S	10/2015	Schweigert
D543,598 S	5/2007	Kuan et al.		D748,213 S	1/2016	Parsons et al.
D543,601 S	5/2007	Kawami		D748,215 S	1/2016	Parsons et al.
D555,219 S	11/2007	Lin		D753,252 S	4/2016	Schweigert
D556,277 S	11/2007	Broom		D893,655 S *	8/2020	Schweigert ..... D21/759
7,309,297 B1	12/2007	Solari		D906,453 S *	12/2020	Agrella ..... D21/743
D561,854 S	2/2008	Morris		D906,457 S *	12/2020	Lambeth ..... D21/759
7,331,876 B2	2/2008	Klein		D907,146 S *	1/2021	Cyruulik ..... D21/736
7,351,162 B2	4/2008	Soracco		D907,147 S *	1/2021	Agrella ..... D21/743
D569,460 S *	5/2008	Walker .....	D21/743	2004/0138003 A1	7/2004	Grace
D569,461 S	5/2008	Morris		2004/0180730 A1	9/2004	Franklin
D569,930 S	5/2008	Nehrbas		2006/0052178 A1	3/2006	Franklin
7,396,289 B2	7/2008	Soracco		2006/0094522 A1	5/2006	Tang
D577,086 S	8/2008	Nicolette et al.		2006/0223649 A1	10/2006	Rife
D577,085 S	9/2008	Nicolette et al.		2007/0129163 A1	6/2007	Solari
D579,506 S	10/2008	Nicolette et al.		2007/0135229 A1	6/2007	Lo
D579,995 S	11/2008	Nicolette et al.		2007/0142122 A1	6/2007	Bonneau
D582,497 S	12/2008	Rollinson		2007/0207875 A1	9/2007	Kuan
7,473,189 B2	1/2009	Schweigert		2007/0238548 A1	10/2007	Johnson
7,491,131 B2	2/2009	Vinton		2008/0139333 A1	6/2008	Klein
D595,793 S	7/2009	Rollinson		2008/0146372 A1	6/2008	John
D599,425 S	9/2009	Laub		2008/0176672 A1	7/2008	Roach
D600,762 S *	9/2009	Serrano .....	D21/743	2009/0029800 A1	1/2009	Jones
D600,763 S	9/2009	Cameron		2010/0255922 A1	10/2010	Lueders
7,744,485 B2	6/2010	Jones		2011/0165959 A1	7/2011	Klein
D619,666 S *	7/2010	DePaul .....	D21/743	2013/0165256 A1	6/2013	Stevenson
D620,993 S	8/2010	Laub		2013/0210537 A1	8/2013	Ainscough
D621,461 S	8/2010	Serrano		2015/0057100 A1	2/2015	Serrano
D623,709 S	9/2010	Serrano et al.		2015/0258390 A1	9/2015	Defrancesco, Jr.
7,867,104 B2 *	1/2011	Franklin ..... A63B 53/0487 473/251		2015/0306477 A1	10/2015	Parsons
D631,925 S	2/2011	Broom		2016/0016050 A1	1/2016	Rife
7,887,432 B2	2/2011	Jones		2018/0001163 A1	1/2018	Becktor
7,909,707 B2	3/2011	Klein		2018/0311545 A1 *	11/2018	Lambeth ..... B23P 15/00
7,918,745 B2	4/2011	Morris		2019/0175995 A1 *	6/2019	Krolloff ..... A63B 53/04
D638,891 S	5/2011	Nicolette et al.		2019/0175996 A1 *	6/2019	Krolloff ..... A63B 53/0487
7,942,758 B2	5/2011	Nakamura		2020/0061421 A1 *	2/2020	Krolloff ..... A63B 1/00
D642,643 S	8/2011	Nicolette et al.				
D643,485 S	8/2011	Nicolette et al.				
D645,104 S	9/2011	Nicolette et al.				
8,096,039 B2	1/2012	Soracco				
D653,718 S	2/2012	Stokke et al.				
D657,836 S *	4/2012	Oldknow .....	D21/759			
D657,837 S *	4/2012	Oldknow .....	D21/759			
D658,245 S *	4/2012	Oldknow .....	D21/736			
D661,753 S	6/2012	Cameron et al.				
D666,260 S	8/2012	Cynn				
8,303,434 B1 *	11/2012	DePaul ..... A63B 53/0487 473/341				
8,371,958 B2	2/2013	Treadwell				
8,376,876 B2	2/2013	Bennett				
D688,339 S	8/2013	Hilton et al.				
D688,341 S	8/2013	Rollinson				
D691,226 S	10/2013	Hilton et al.				
D699,308 S	2/2014	Rollinson				
8,696,492 B1	4/2014	Hocknell				
D704,782 S	5/2014	Rollinson				
8,721,472 B2	5/2014	Kuan				
8,790,193 B2	7/2014	Serrano				
D711,483 S	8/2014	Wong				

## FOREIGN PATENT DOCUMENTS

JP	2004223184 A	8/2004
JP	2005160691	6/2005
KR	200377377 Y1	3/2005
KR	200403045 Y1	12/2005
KR	20100065481 A	6/2010
KR	101773069 B1	5/2016

## OTHER PUBLICATIONS

U.S. Appl. No. 29/523,587, Schweigert, "Golf Club Head," filed Apr. 10, 2015.

TourSpecGolf (Gold's Factory Multi Weighted Custom Putter) [online]. Nov. 20, 2010 [retrieved Apr. 26, 2016] Retrieved from the internet: <URL: <http://www.tourspecgolf.com/blog/golds-factory-multi-weighted-custom-putter/>>.

Plugged in Golf (2015 Bettinardi Putters Review) [online]. Mar. 3, 2015 [retrieve Nov. 25, 2019] Retrieve from the internet: <URL: <https://pluggedingolf.com/2015-bettinardi-putters-review/>>.

\* cited by examiner

*Primary Examiner* — Mitchell I. Siegel

(57) **CLAIM**

The ornamental design for a golf club head, as shown and described.

**DESCRIPTION**

FIG. 1 is a top perspective view of a golf club head;  
FIG. 2 is a bottom perspective view of the golf club head of FIG. 1;  
FIG. 3 is a front elevational view of the golf club head of FIG. 1;  
FIG. 4 is a rear elevational view of the golf club head of FIG. 1;  
FIG. 5 is a top view of the golf club head of FIG. 1;  
FIG. 6 is a bottom view of the golf club head of FIG. 1;  
FIG. 7 is a left side view of the golf club head of FIG. 1;  
FIG. 8 is a right side view of the golf club head of FIG. 1;  
FIG. 9 is a top perspective view of a golf club head;  
FIG. 10 is a bottom perspective view of the golf club head of FIG. 9;  
FIG. 11 is a front elevational view of the golf club head of FIG. 9;  
FIG. 12 is a rear elevational view of the golf club head of FIG. 9;  
FIG. 13 is a top view of the golf club head of FIG. 9;

FIG. 14 is a bottom view of the golf club head of FIG. 9;  
FIG. 15 is a left side view of the golf club head of FIG. 9;  
FIG. 16 is a right side view of the golf club head of FIG. 9;  
FIG. 17 is a top perspective view of a golf club head;  
FIG. 18 is a bottom perspective view of the golf club head of FIG. 17;  
FIG. 19 is a front elevational view of the golf club head of FIG. 17;  
FIG. 20 is a rear elevational view of the golf club head of FIG. 17;  
FIG. 21 is a top view of the golf club head of FIG. 17;  
FIG. 22 is a bottom view of the golf club head of FIG. 17;  
FIG. 23 is a left side view of the golf club head of FIG. 17;  
FIG. 24 is a right side view of the golf club head of FIG. 17;  
FIG. 25 is a top perspective view of a golf club head;  
FIG. 26 is a bottom perspective view of the golf club head of FIG. 25;  
FIG. 27 is a front elevational view of the golf club head of FIG. 25;  
FIG. 28 is a rear elevational view of the golf club head of FIG. 25;  
FIG. 29 is a top view of the golf club head of FIG. 25;  
FIG. 30 is a bottom view of the golf club head of FIG. 25;  
FIG. 31 is a left side view of the golf club head of FIG. 25;  
and,  
FIG. 32 is a right side view of the golf club head of FIG. 25.  
The broken lines shown on the drawing figures form no part of the claimed design.

**1 Claim, 28 Drawing Sheets**



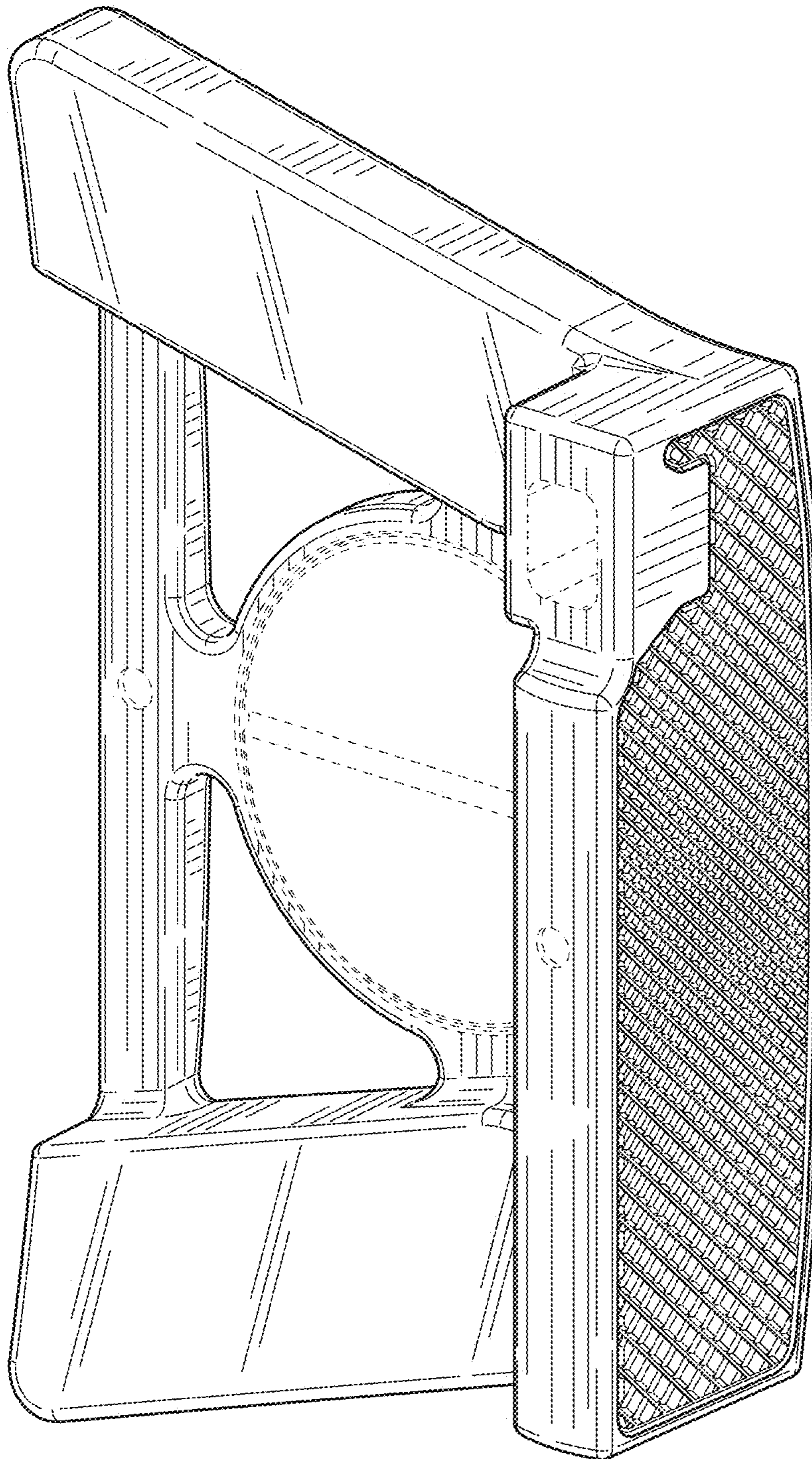

FIG. 1

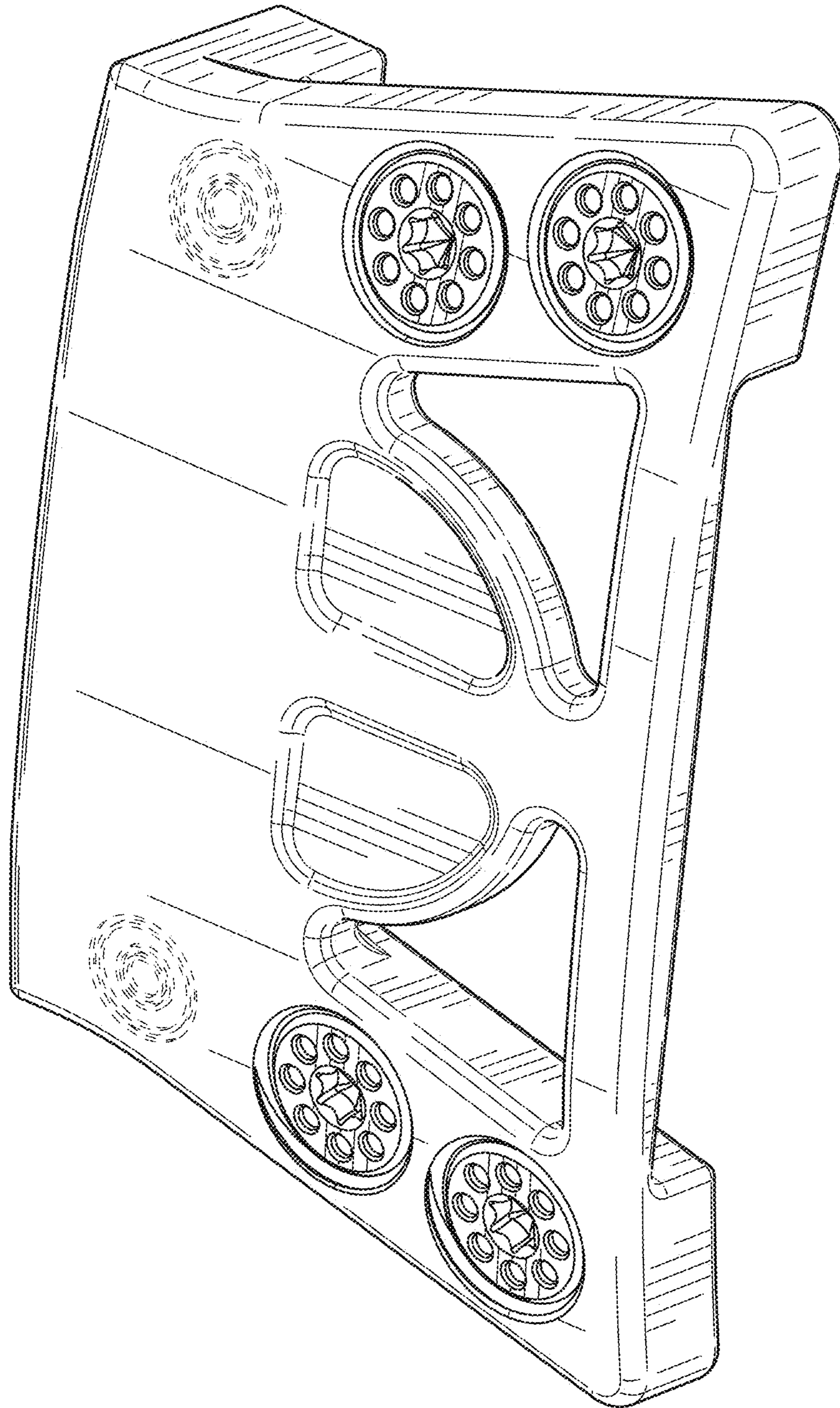

FIG. 2



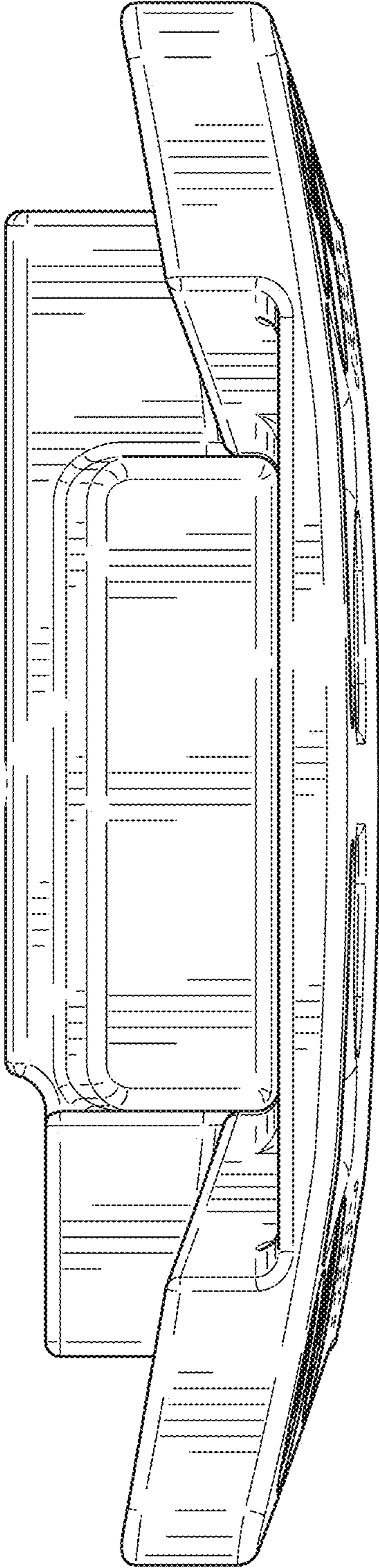

FIG. 3

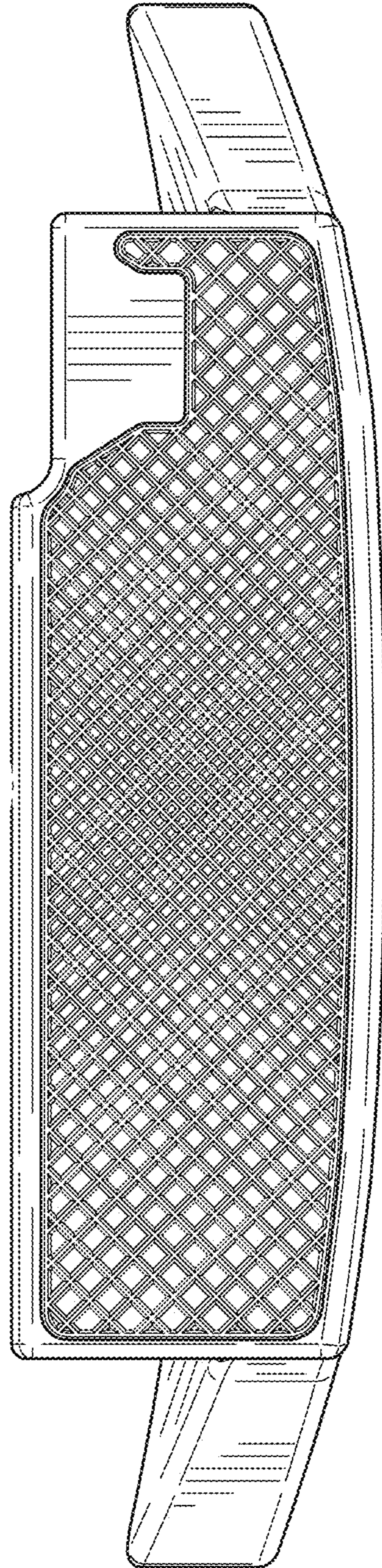

FIG. 4

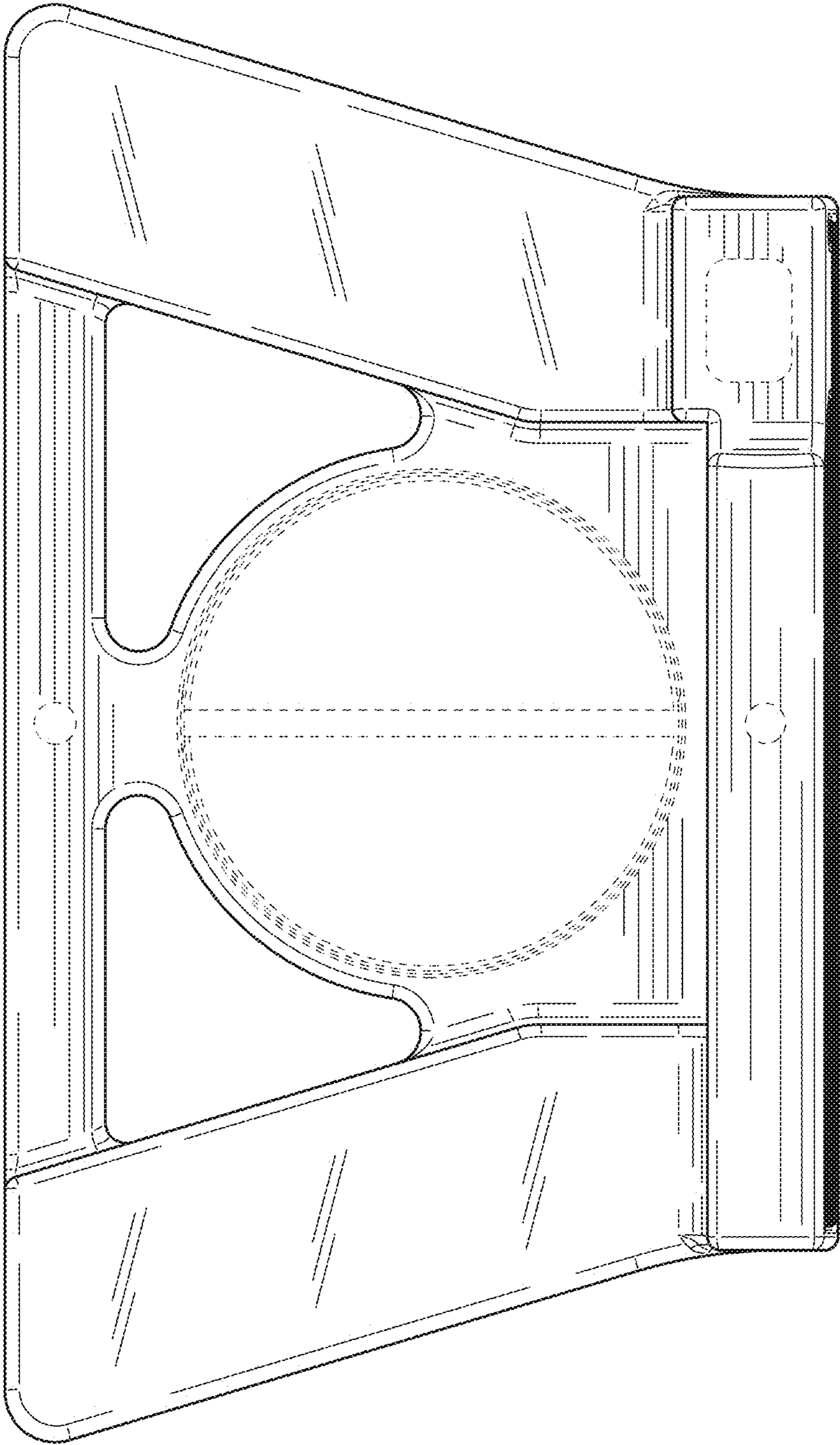

FIG. 5



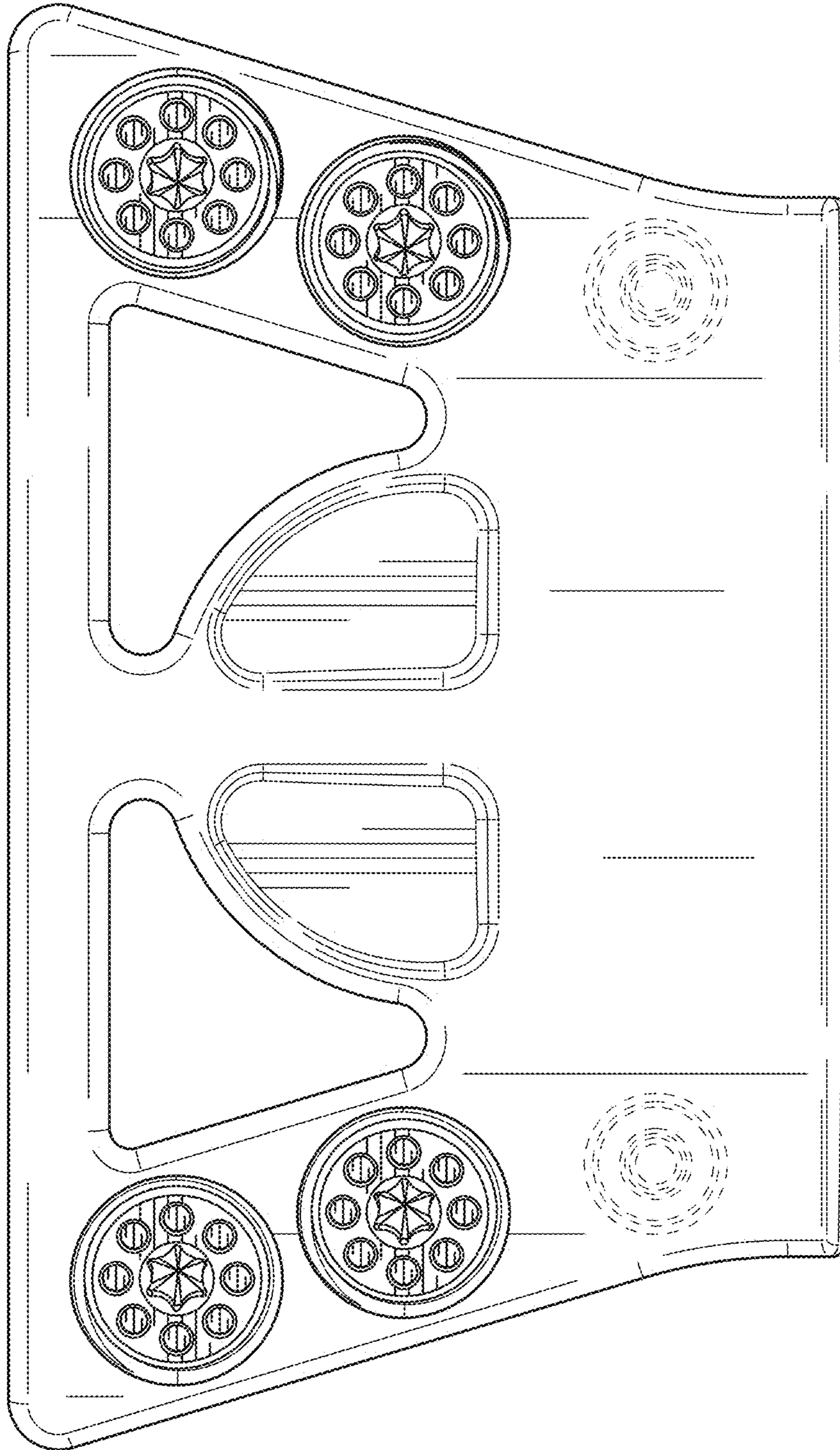

FIG. 6

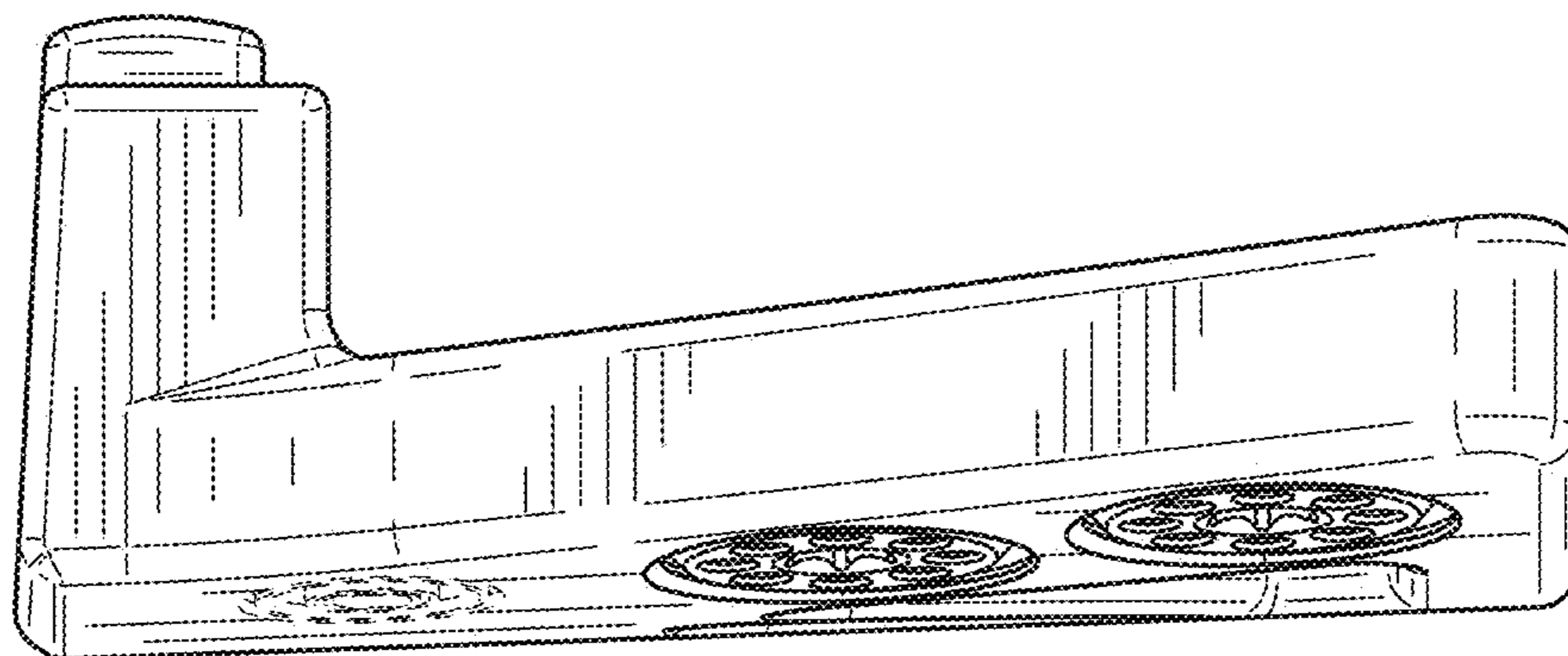

FIG. 7

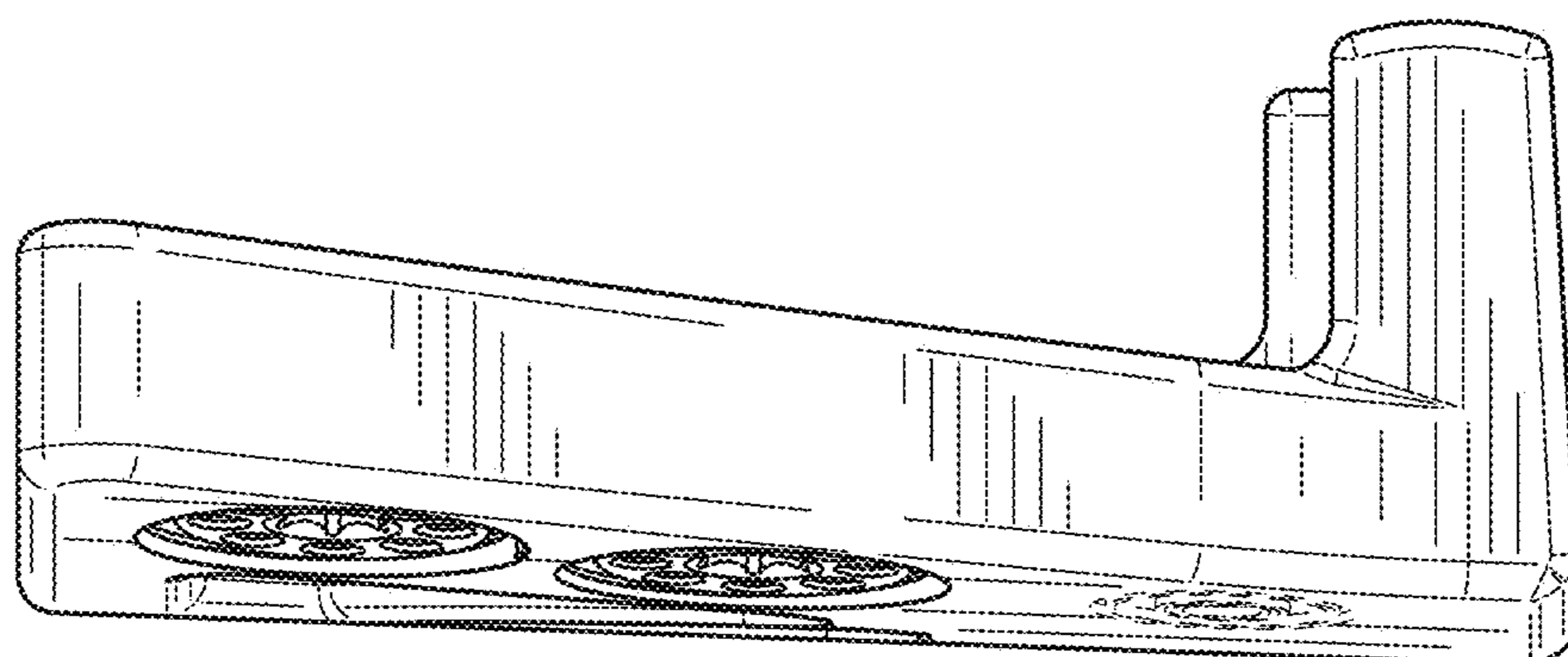

FIG. 8



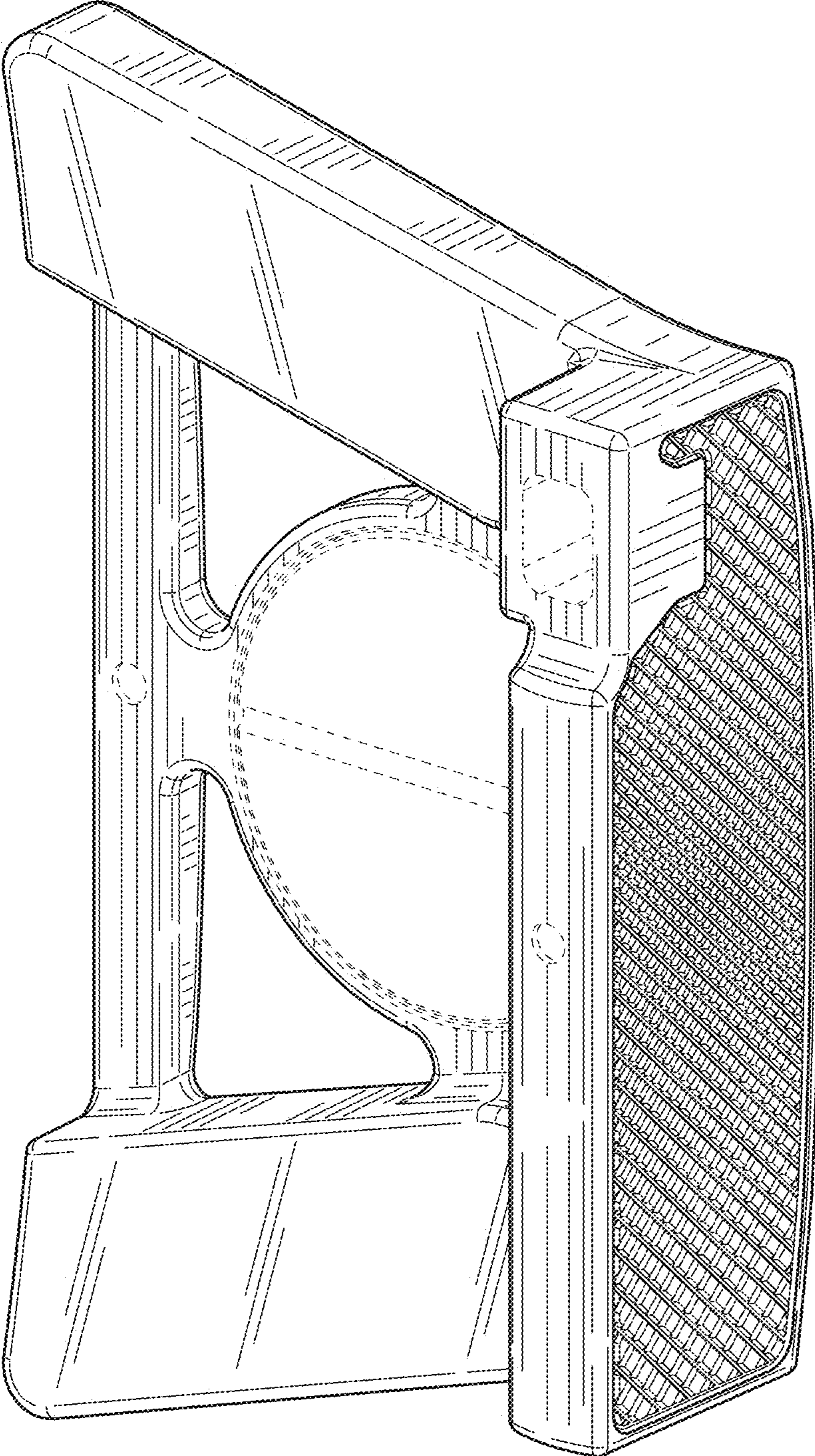

FIG. 9

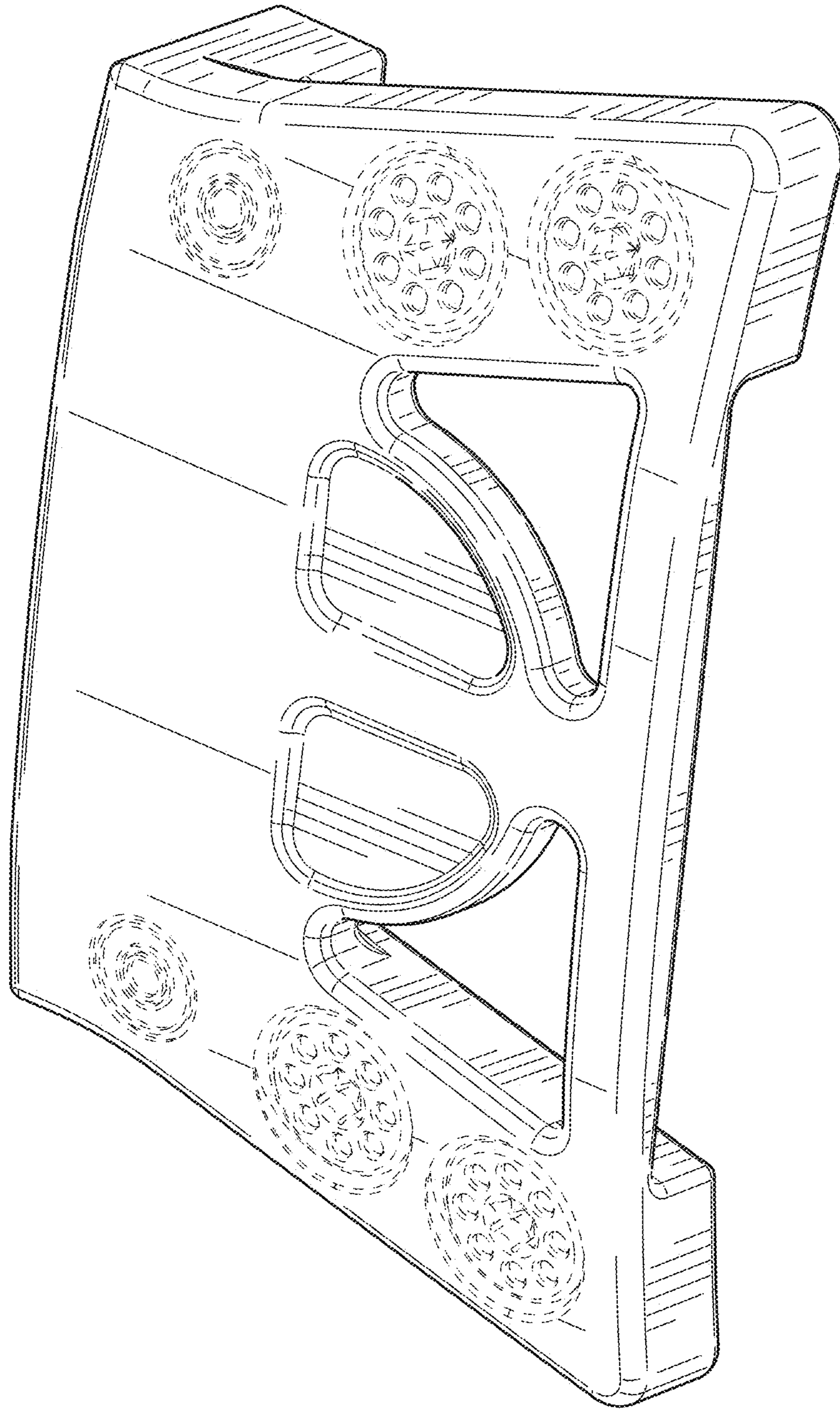

FIG. 10



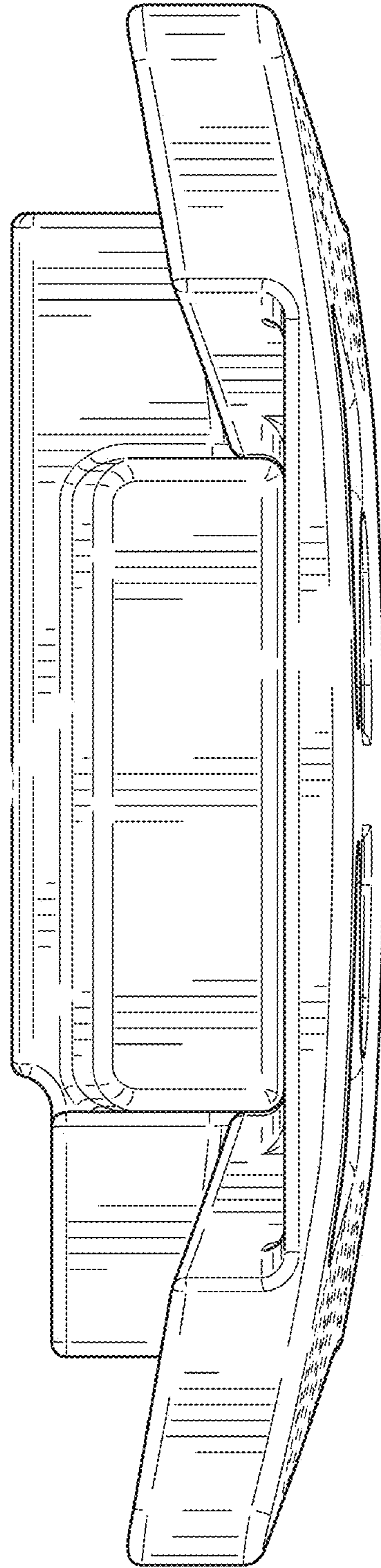

FIG. 11

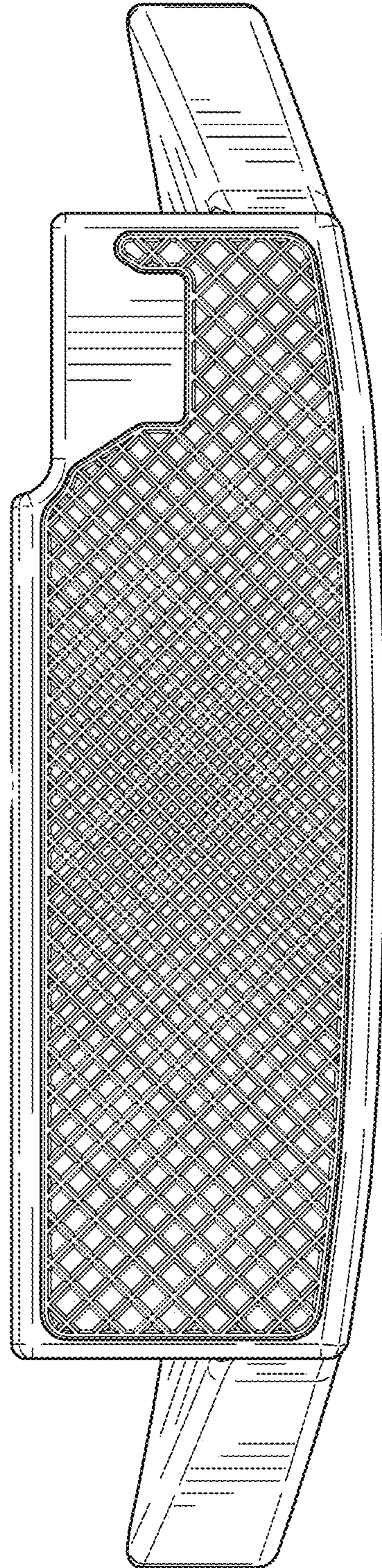

FIG. 12



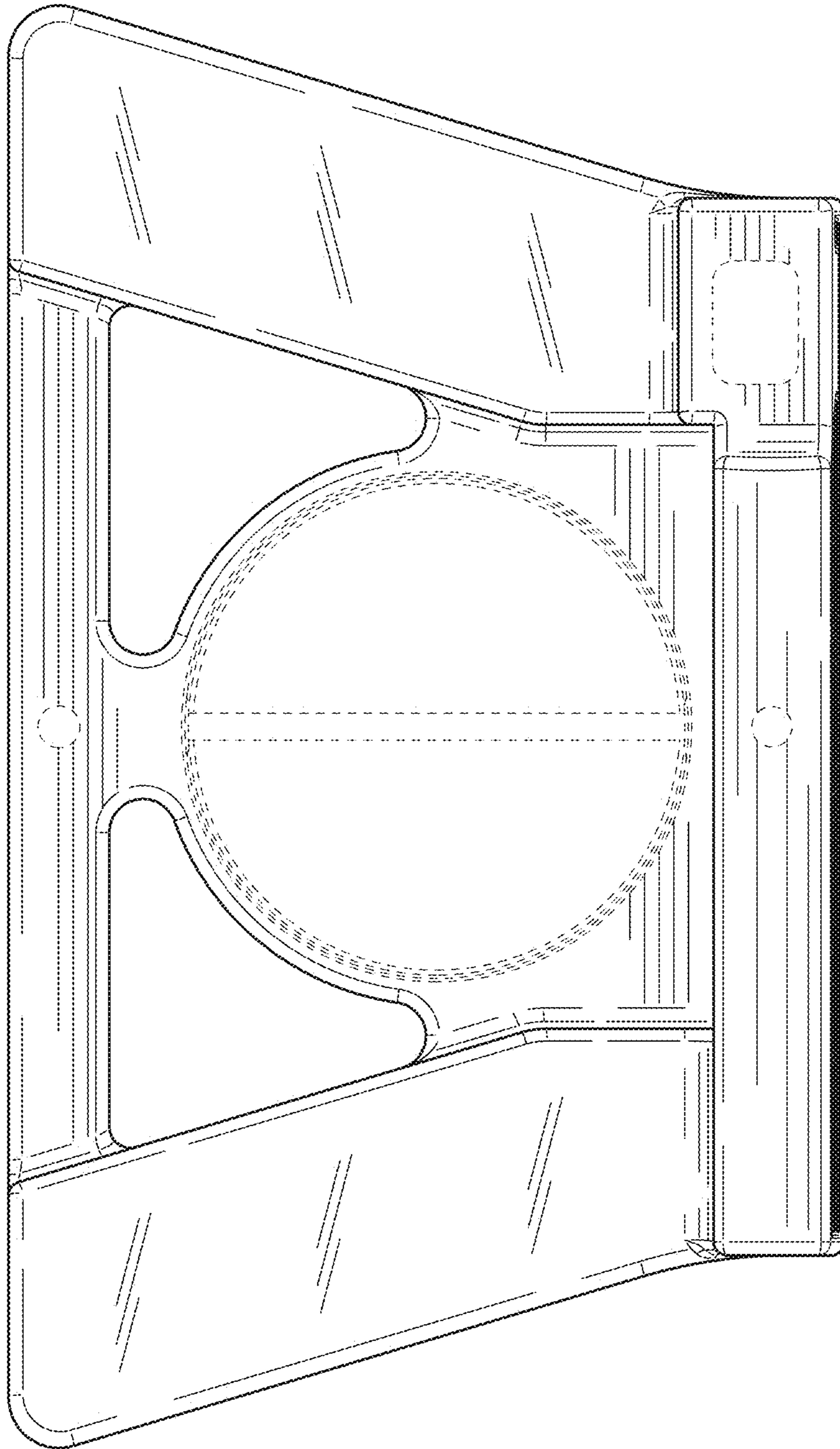

FIG. 13

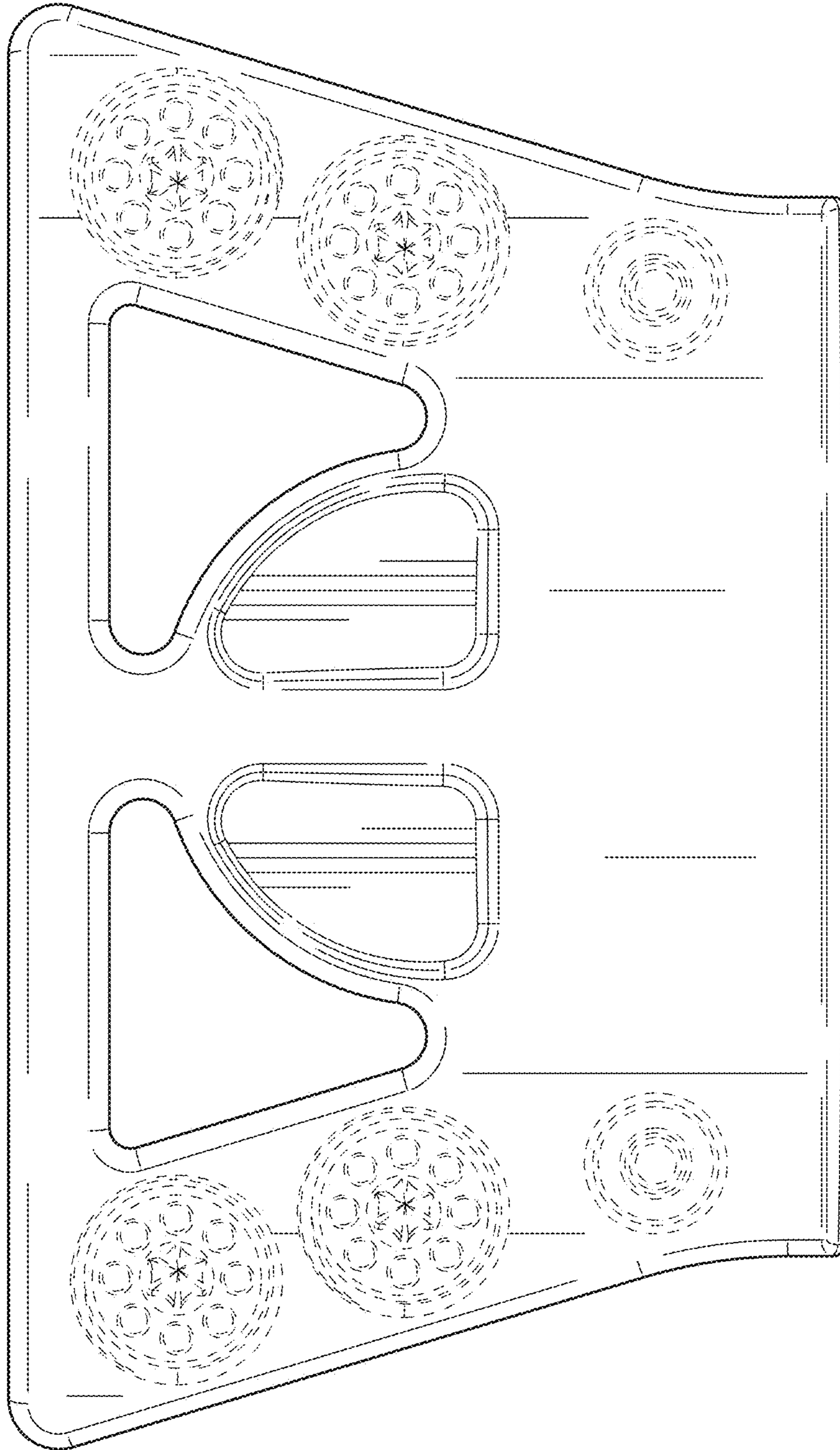

FIG. 14



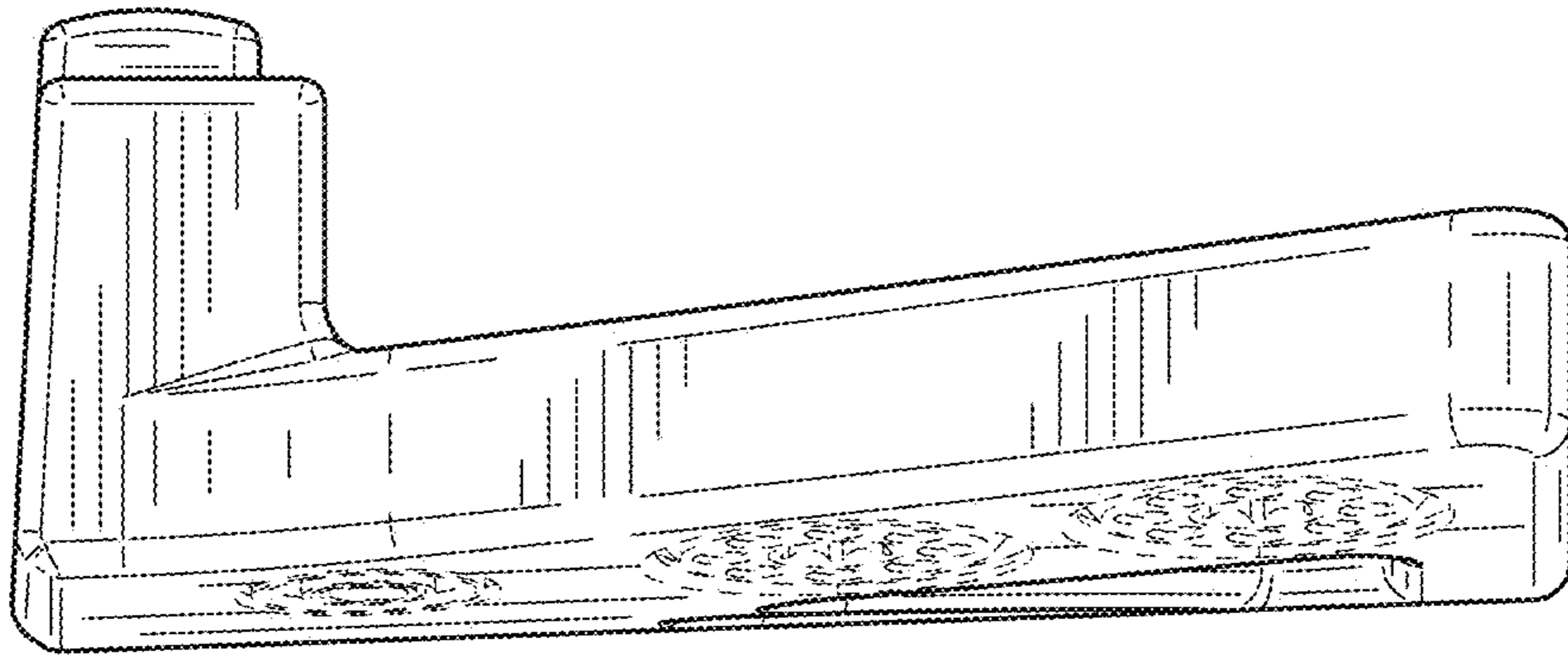

FIG. 15

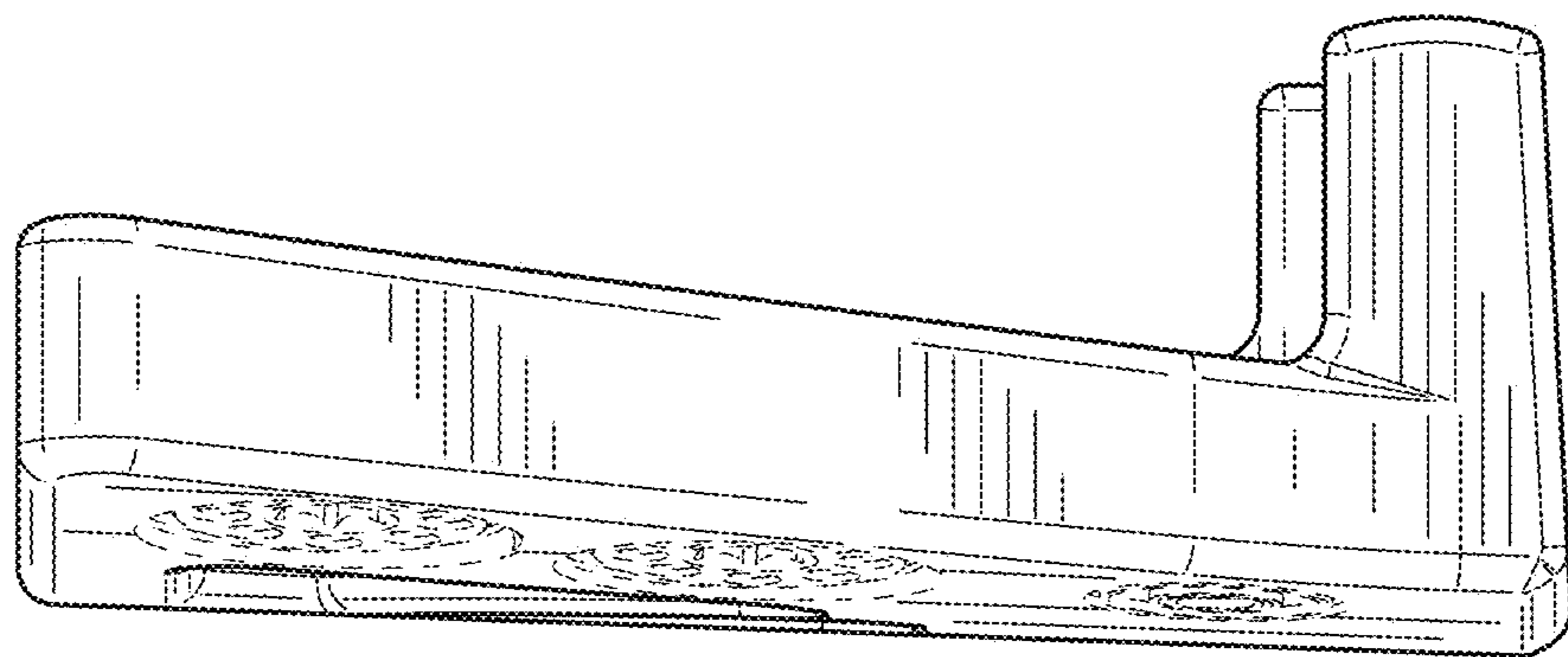

FIG. 16

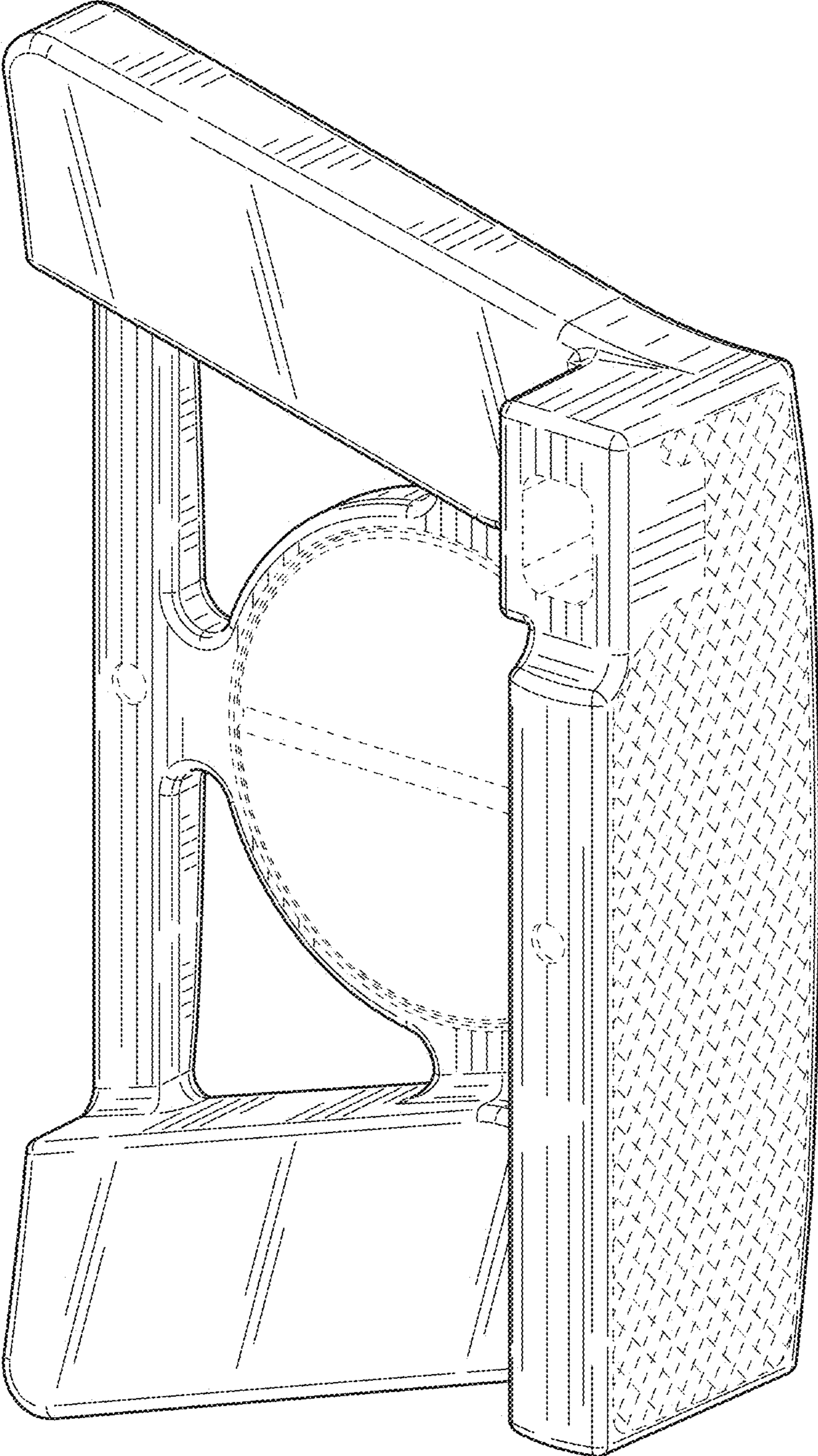

FIG. 17



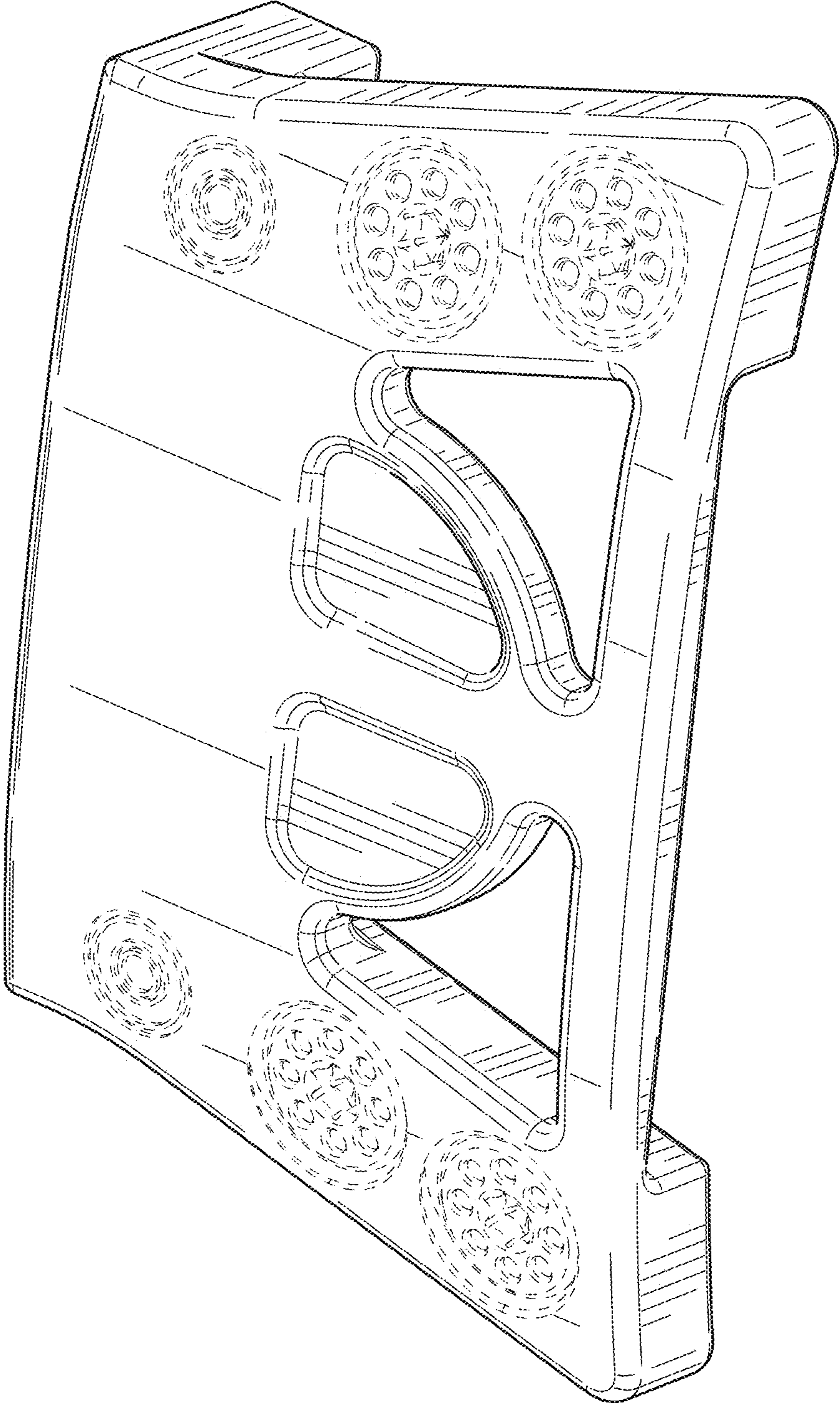

FIG. 18

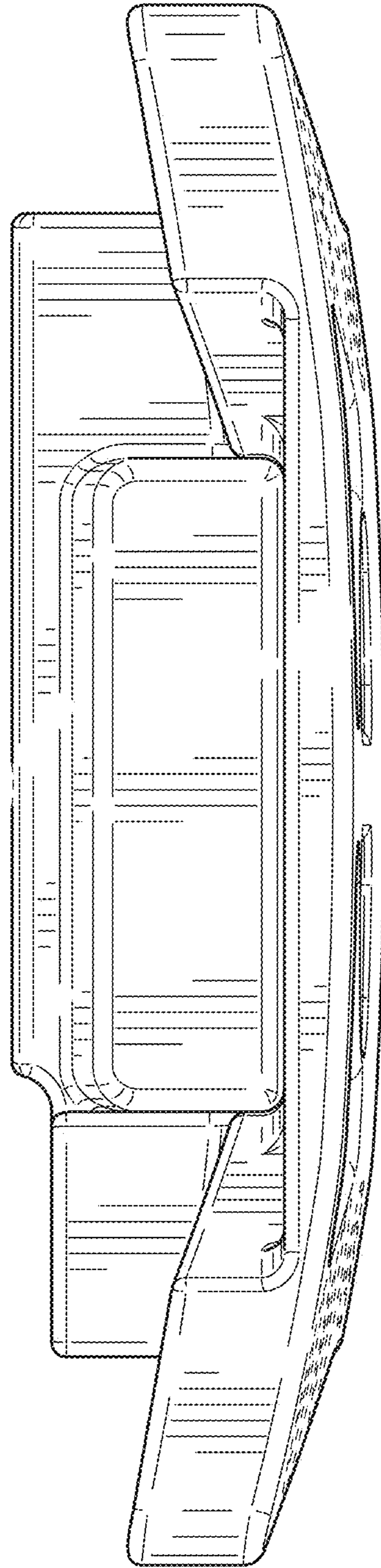

FIG. 19



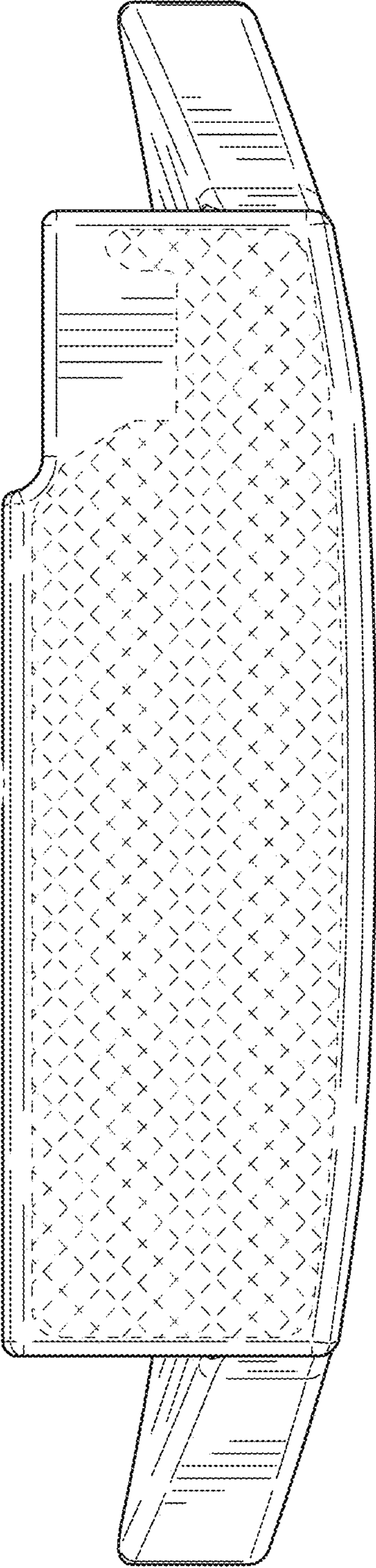

FIG. 20

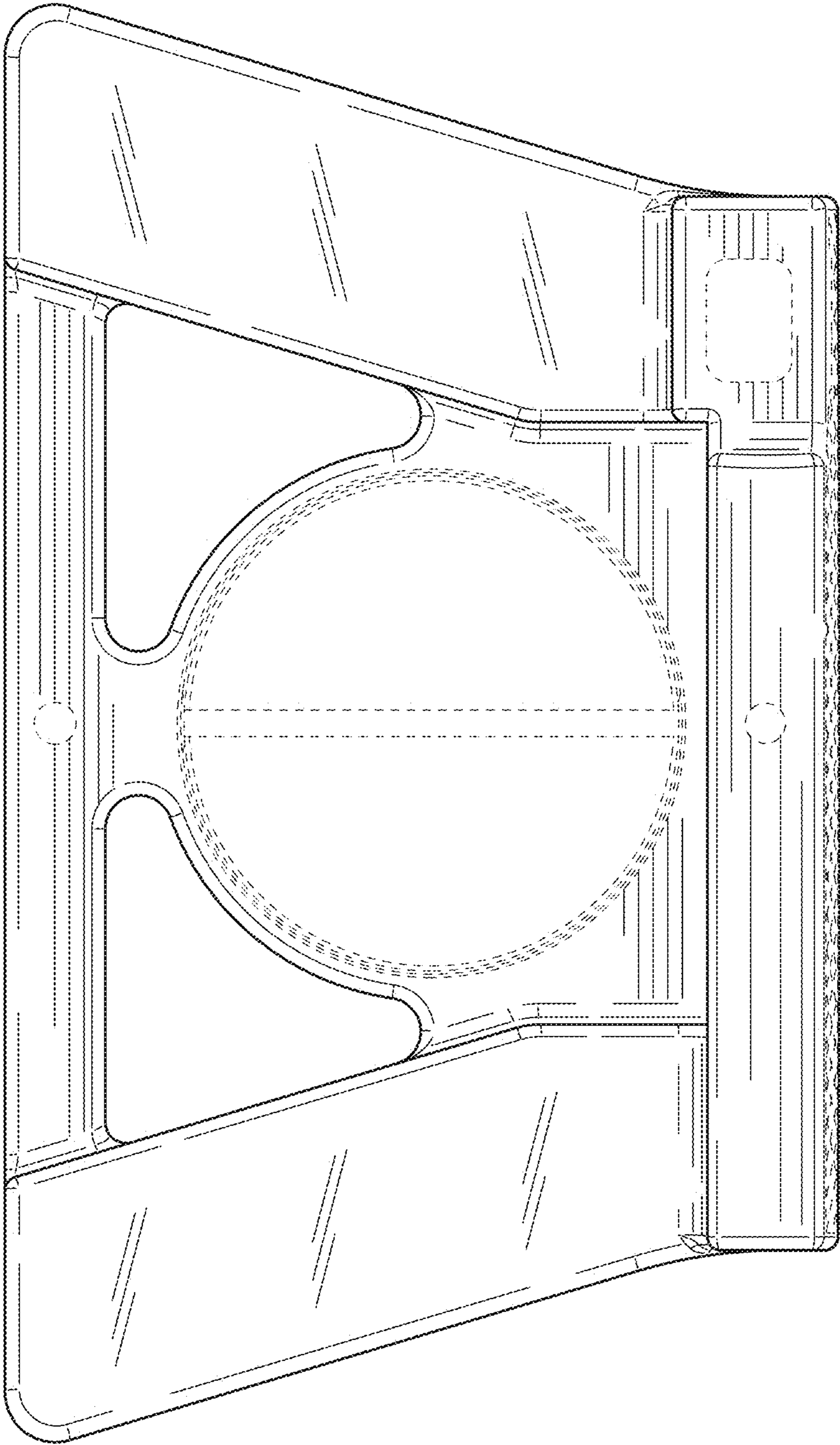

FIG. 21



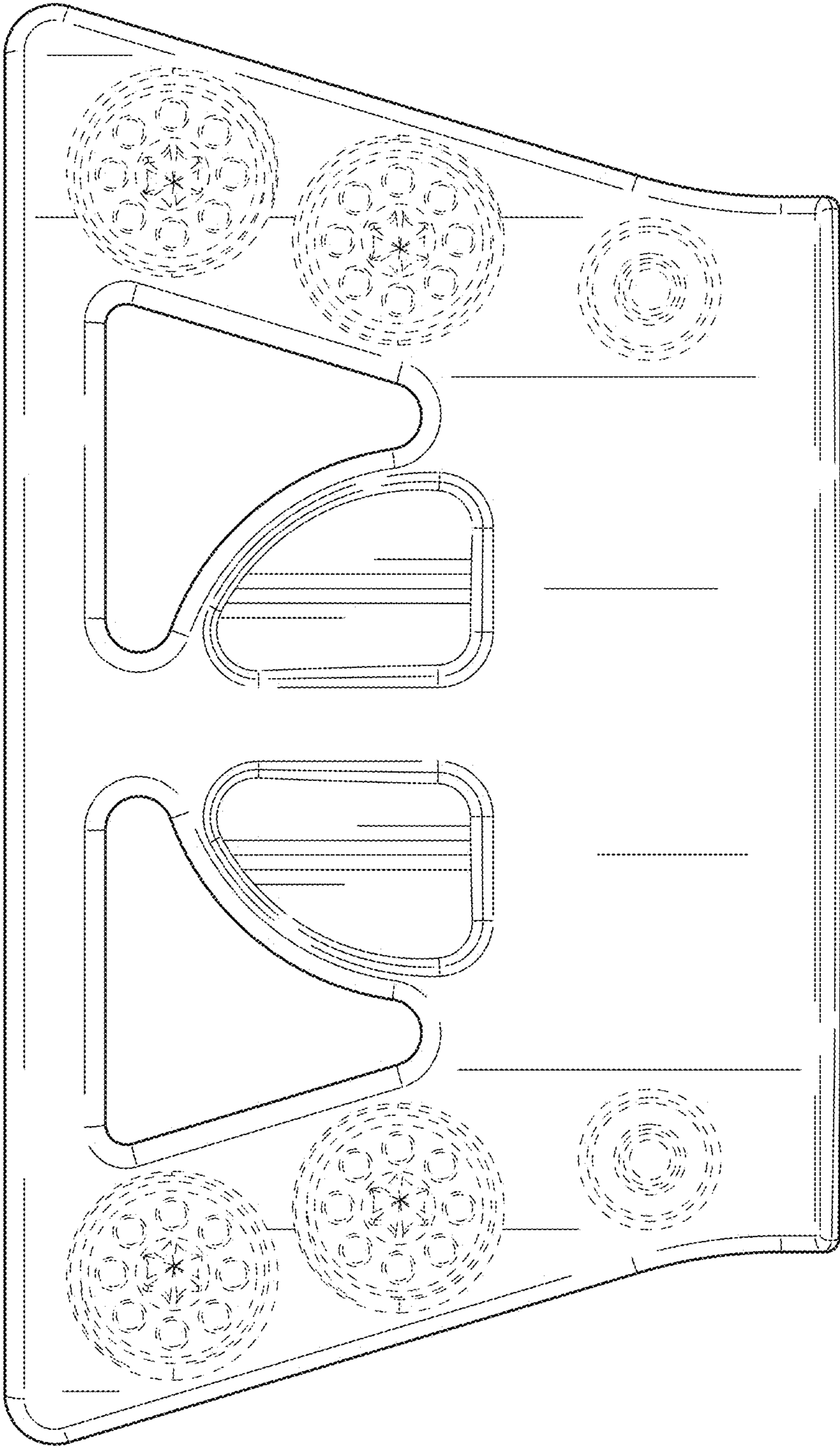

FIG. 22

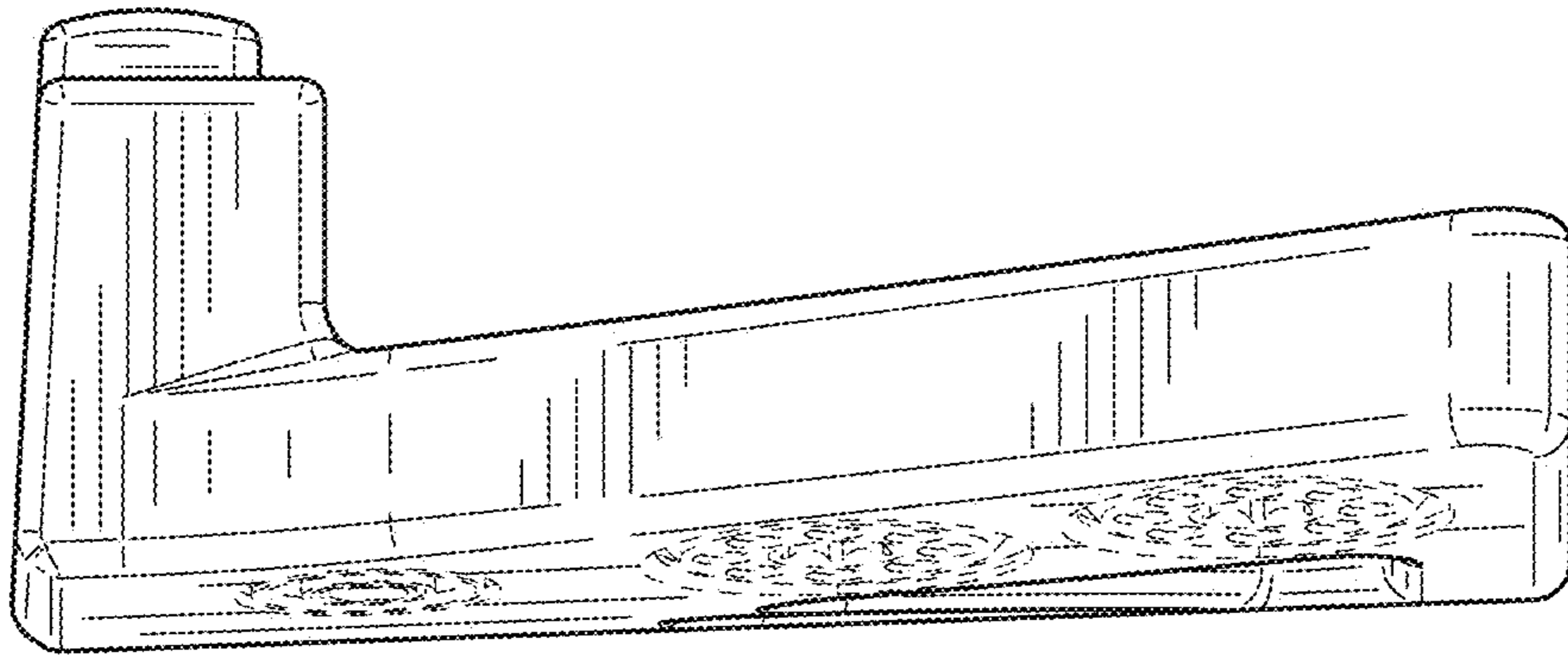

FIG. 23

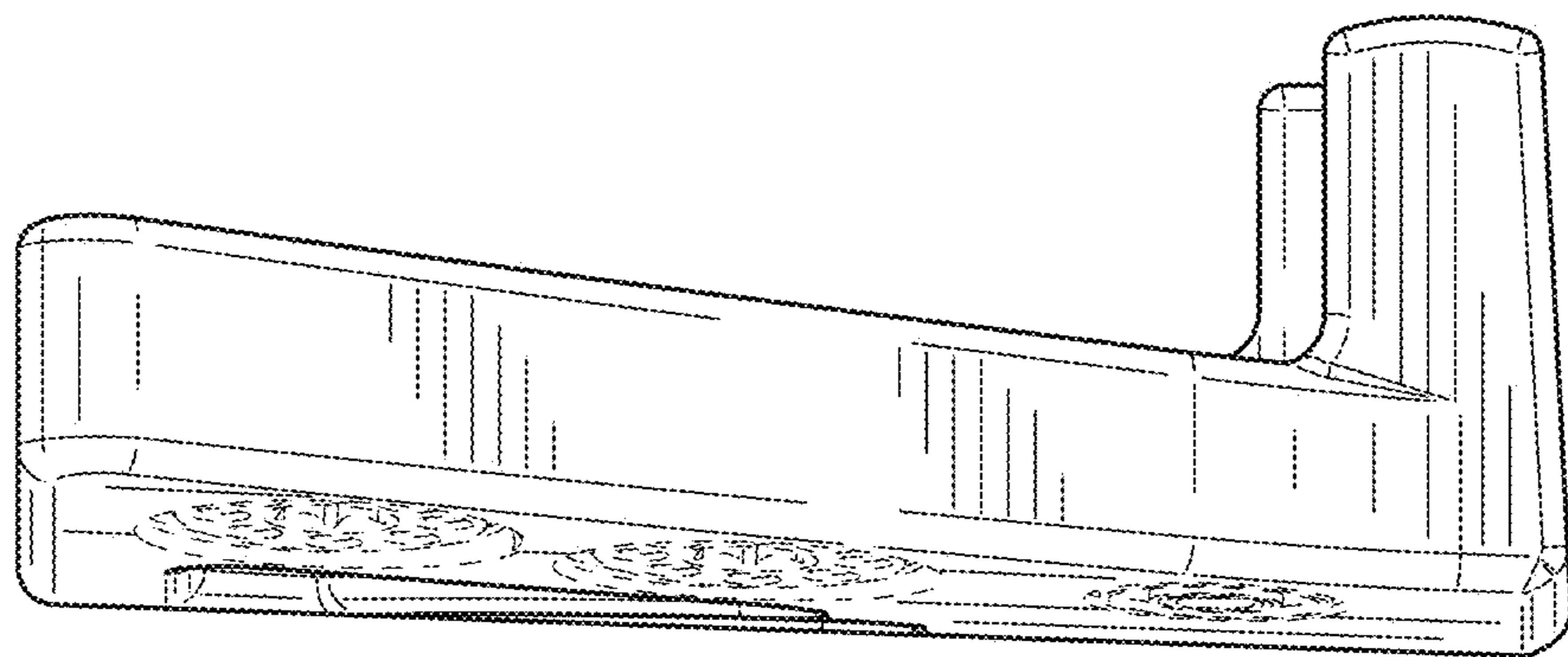

FIG. 24



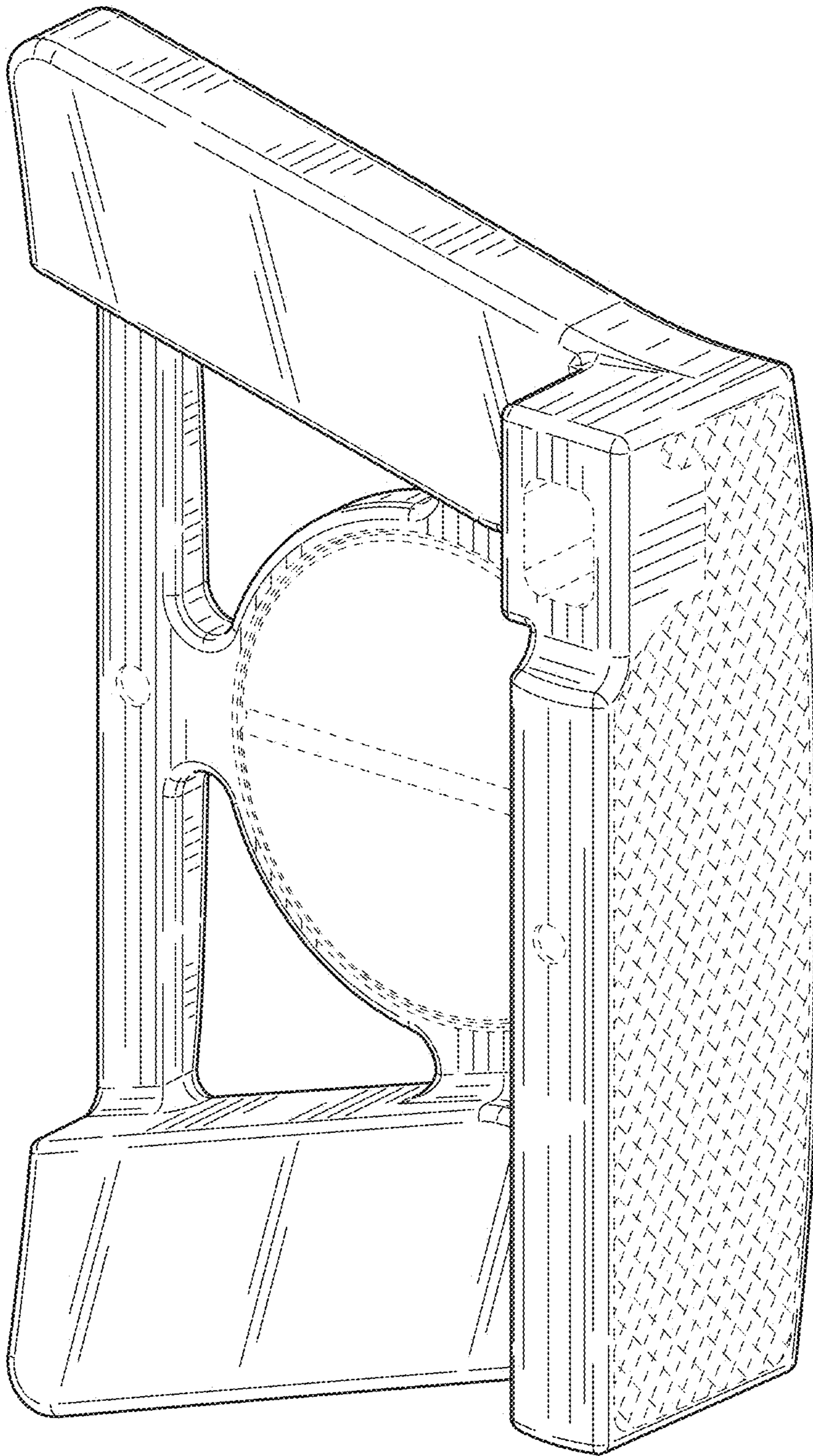

FIG. 25

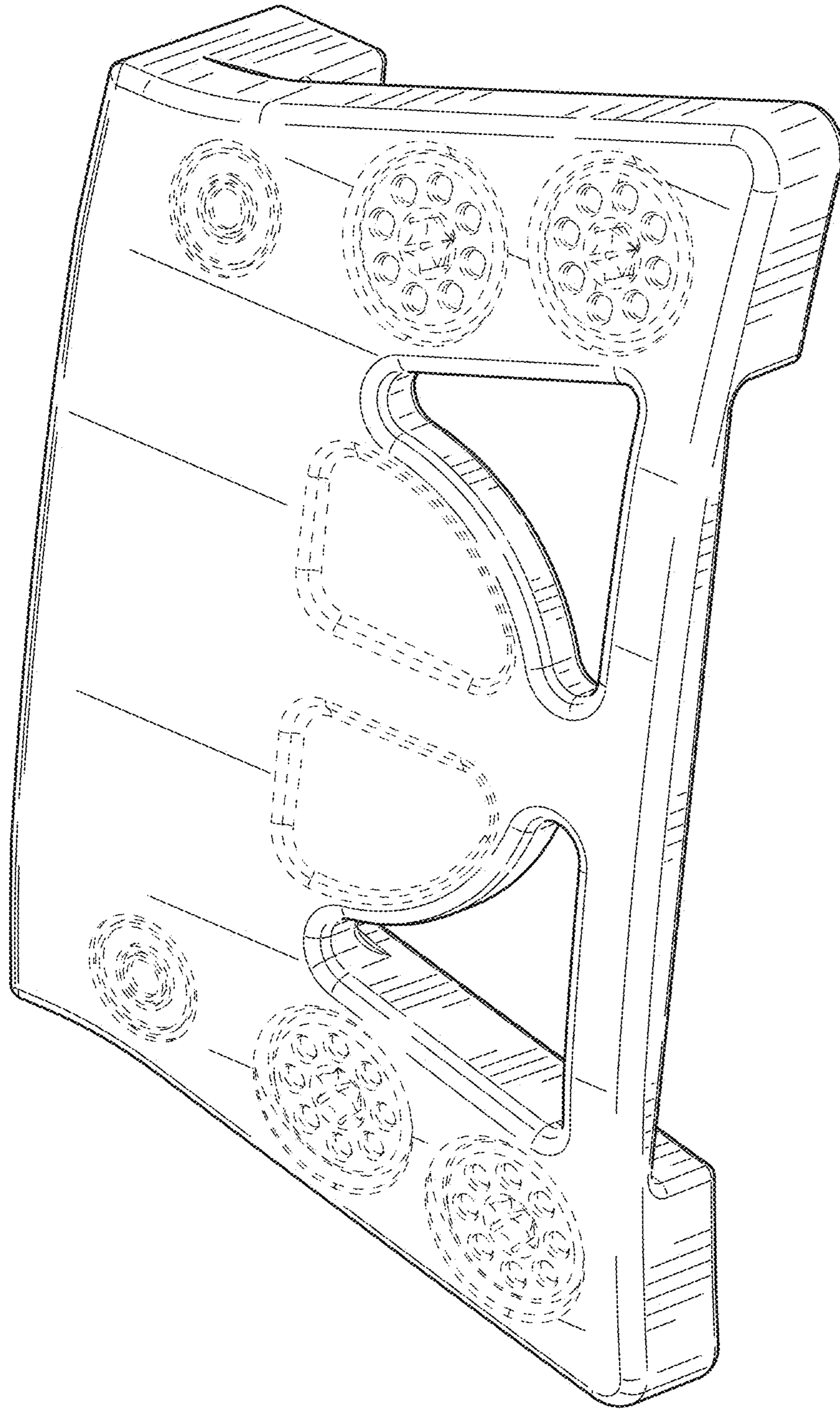

FIG. 26



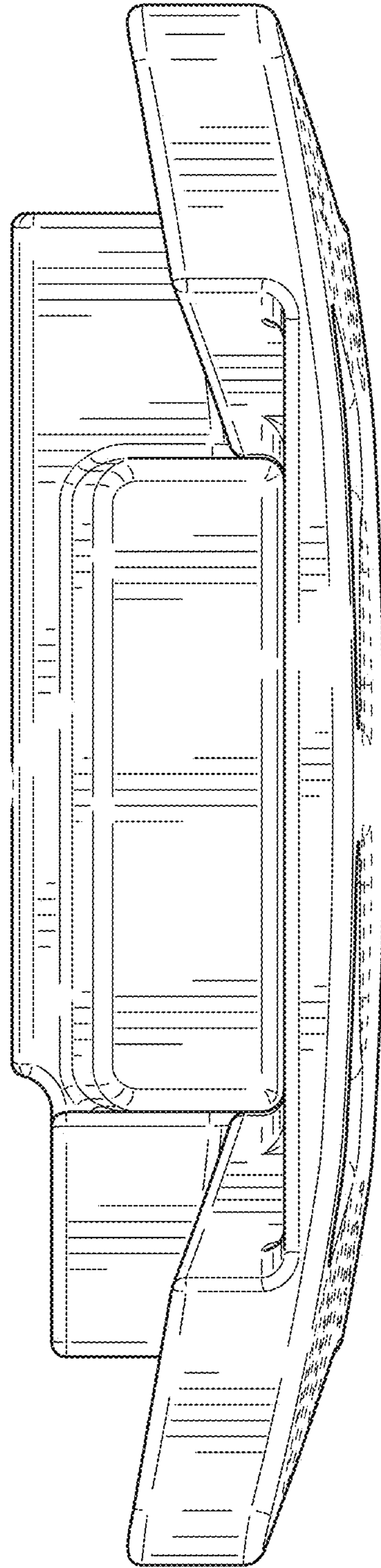

FIG. 27

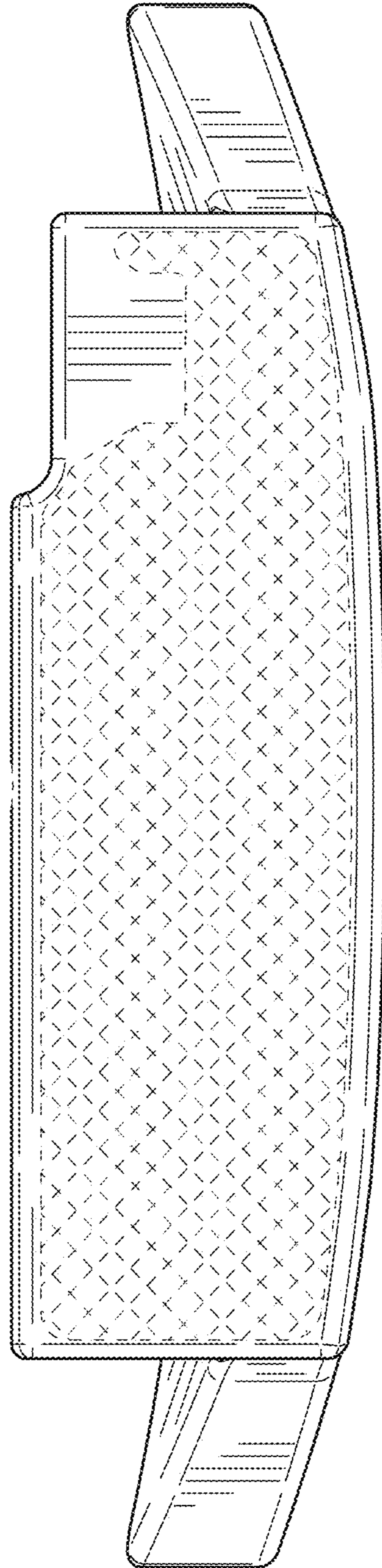

FIG. 28



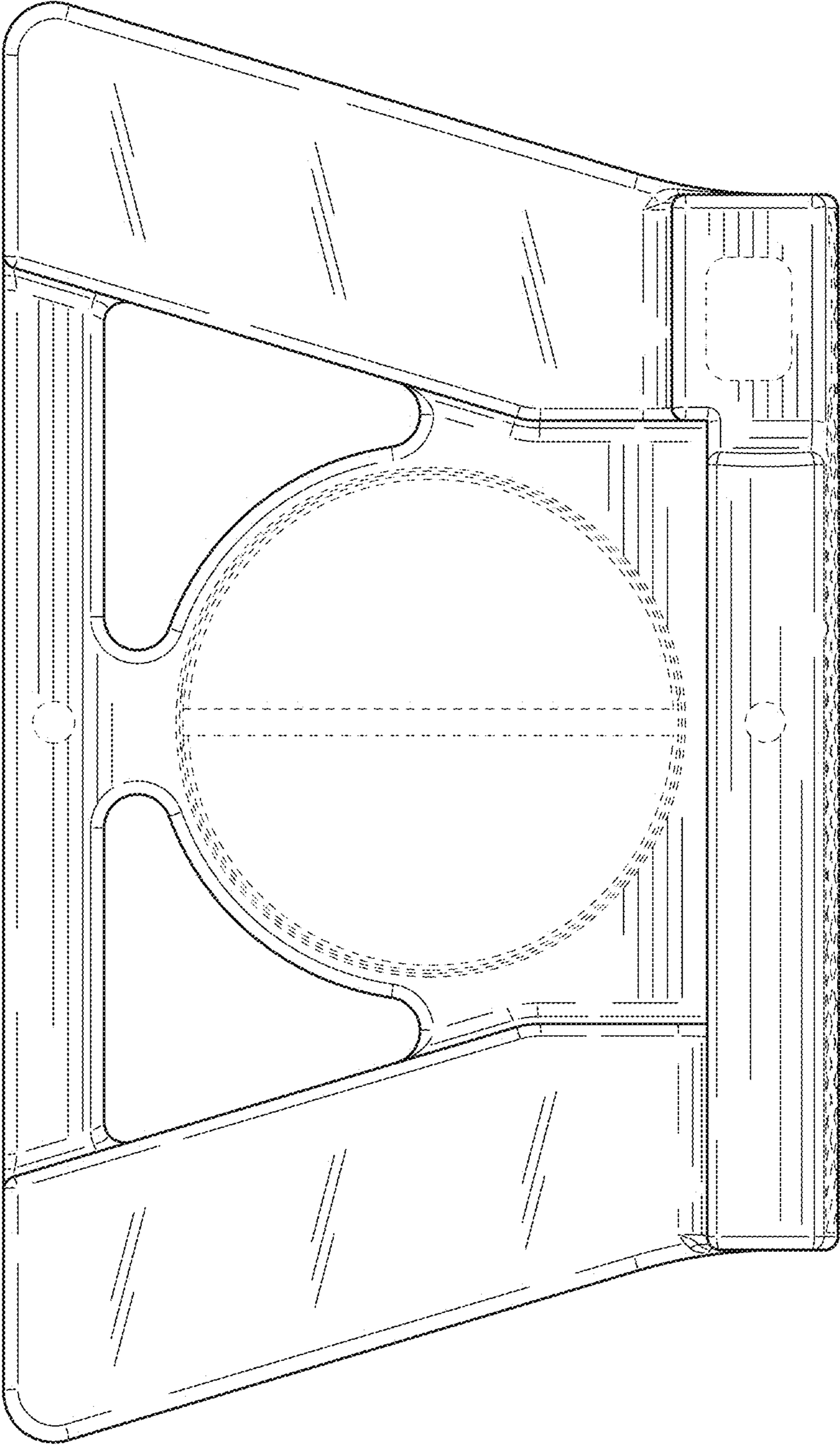

FIG. 29

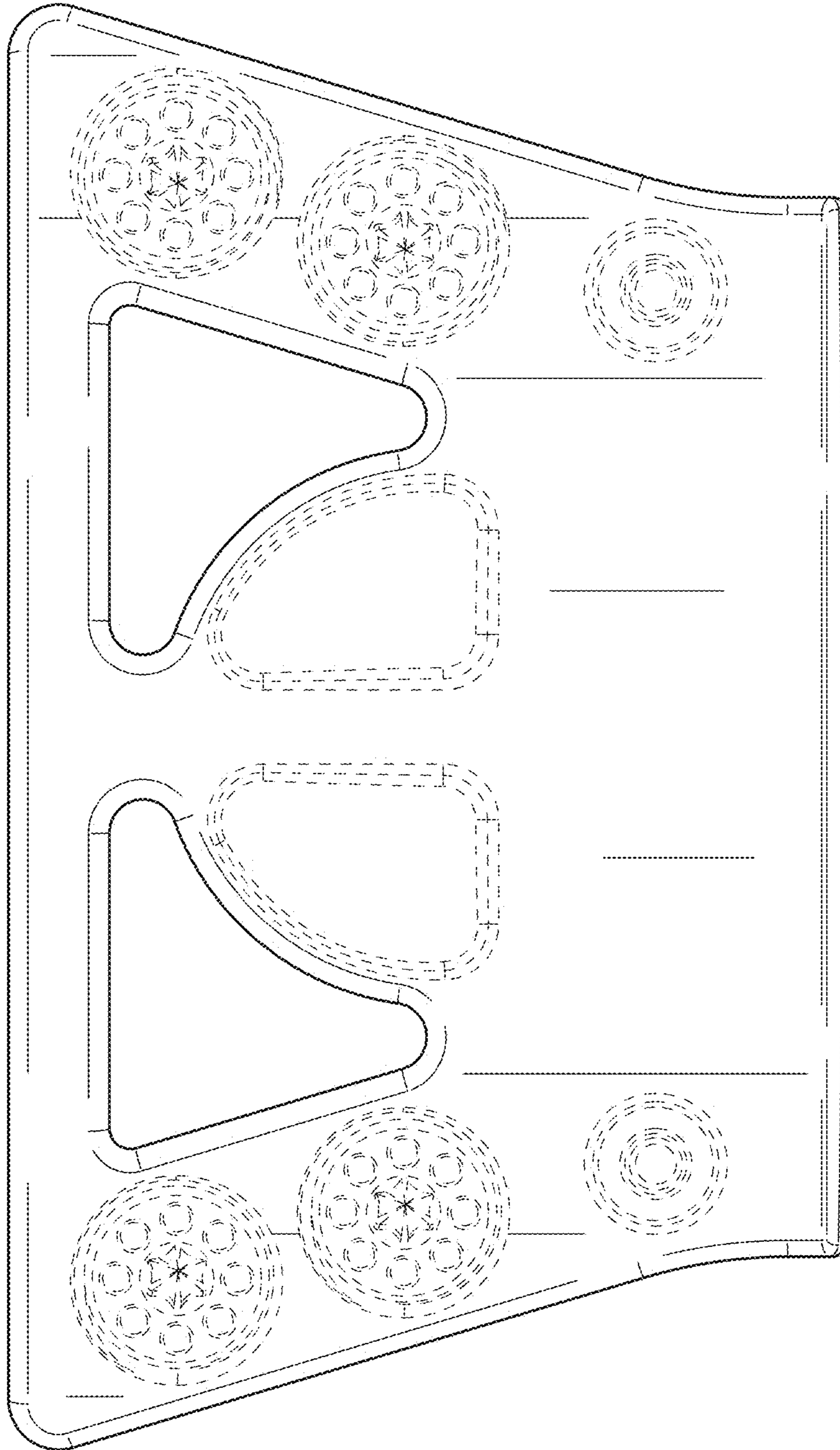

FIG. 30



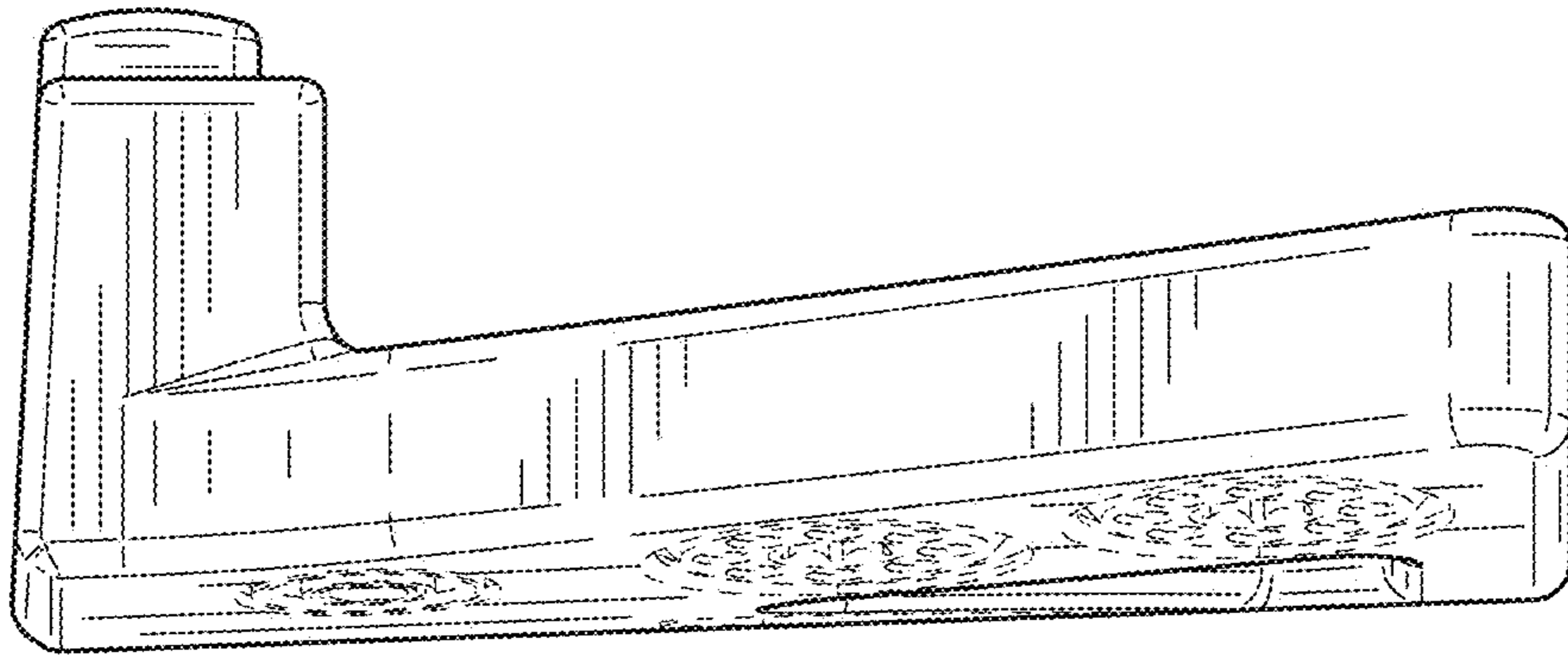

FIG. 31

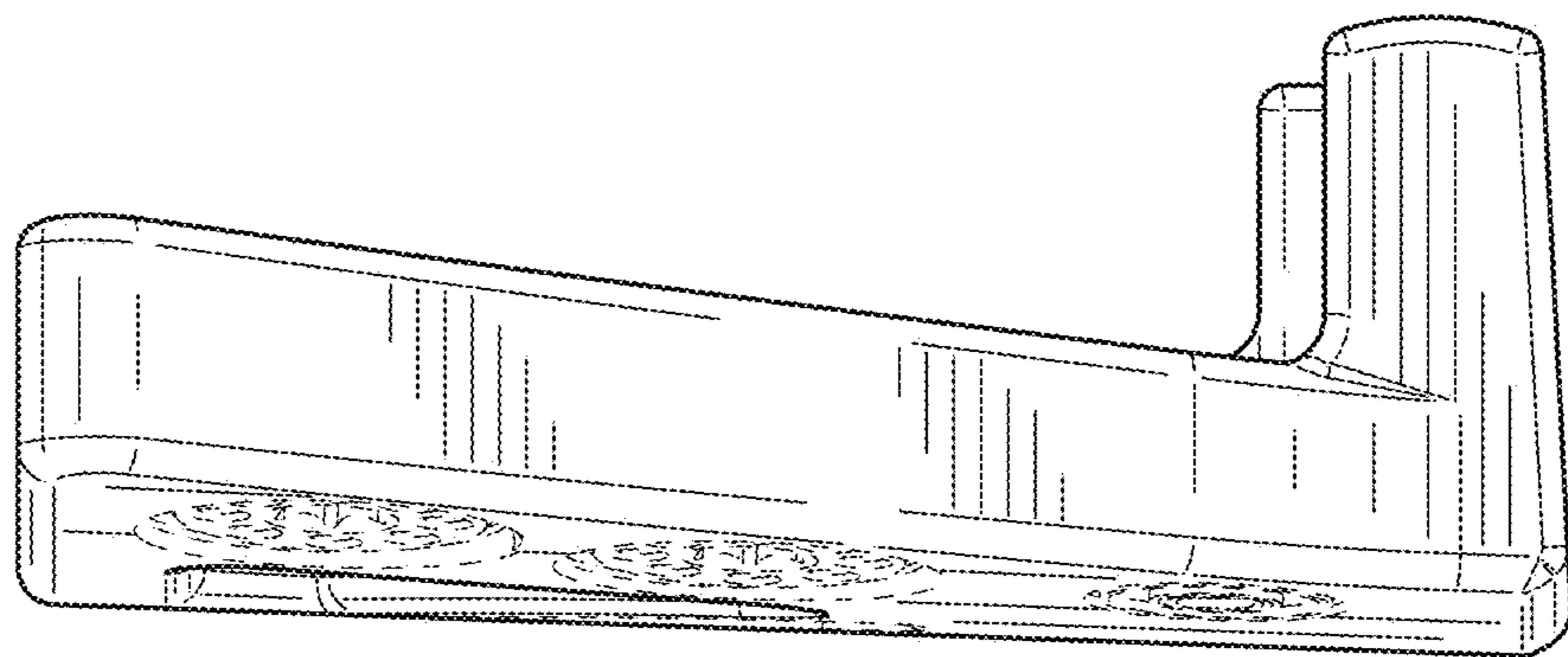

FIG. 32