



US00D920434S

(12) **United States Design Patent**  
**Hwang et al.**

(10) **Patent No.:** **US D920,434 S**  
(45) **Date of Patent:** **\*\* May 25, 2021**

- (54) **DIGITAL SIGNAGE**
- (71) Applicant: **LG ELECTRONICS INC.**, Seoul (KR)
- (72) Inventors: **Jungyeon Hwang**, Seoul (KR); **Yongho Lee**, Seoul (KR)
- (73) Assignee: **LG ELECTRONICS INC.**, Seoul (KR)
- (\*\*) Term: **15 Years**
- (21) Appl. No.: **35/508,186**
- (22) Filed: **Jun. 3, 2019**
- (80) **Hague Agreement Data**  
Int. Filing Date: **Jun. 3, 2019**  
Int. Reg. No.: **DM/204820**  
Int. Reg. Date: **Jun. 3, 2019**  
Int. Reg. Pub. Date: **Dec. 20, 2019**

D750,173 S \* 2/2016 Chen ..... G06F 1/20  
D20/10  
D771,844 S \* 11/2016 Hochman ..... G09F 15/0056  
D26/1  
D805,659 S \* 12/2017 Hochman ..... G09F 13/22  
D26/1  
9,854,613 B2 \* 12/2017 Son ..... H04W 76/11  
10,701,843 B1 \* 6/2020 Kim ..... H05K 7/20145  
2008/0024387 A1 \* 1/2008 Maskeny ..... G09F 9/3026  
345/1.1  
2008/0236045 A1 \* 10/2008 DeBlonk ..... G09F 13/22  
49/55  
2008/0263924 A1 \* 10/2008 Nearman ..... G09F 15/0056  
40/607.13

(Continued)

*Primary Examiner* — Mary Ann Calabrese  
(74) *Attorney, Agent, or Firm* — Birch, Stewart, Kolasch & Birch, LLP

- (30) **Foreign Application Priority Data**  
Dec. 3, 2018 (KR) ..... 30-2018-0056573
- (51) **LOC (13) Cl.** ..... **20-03**
- (52) **U.S. Cl.**  
USPC ..... **D20/42**
- (58) **Field of Classification Search**  
USPC ..... D20/10, 19, 39, 41, 42, 99; D10/113.4;  
D14/125, 126, 371  
CPC ..... G09F 7/00; G09F 7/02; G09F 7/16; G09F  
9/00; G09F 9/3026; G09F 9/33; G09F  
9/35; G09F 13/00; G09F 13/22; G09F  
15/00; G09F 15/0056; G09F 15/0068;  
G06F 3/14; H01R 13/514  
See application file for complete search history.

(57) **CLAIM**

The ornamental design for a digital signage, as shown and described.

**DESCRIPTION**

- 1. Digital signage
- 1.1 : Front perspective view
- 1.2 : Rear perspective view
- 1.3 : Front
- 1.4 : Back
- 1.5 : Left
- 1.6 : Right
- 1.7 : Top
- 1.8 : Bottom
- 1.9 : Reference view

The broken lines indicate portions of the article that form no part of the claimed design; view 1.9 shows one of the display units removed from the frame for the digital signage for clarity of illustration.

- (56) **References Cited**  
U.S. PATENT DOCUMENTS  
D417,468 S \* 12/1999 Van Genechten ..... D20/10  
8,879,243 B2 \* 11/2014 Lee ..... G09F 9/3026  
361/679.02

**1 Claim, 9 Drawing Sheets**

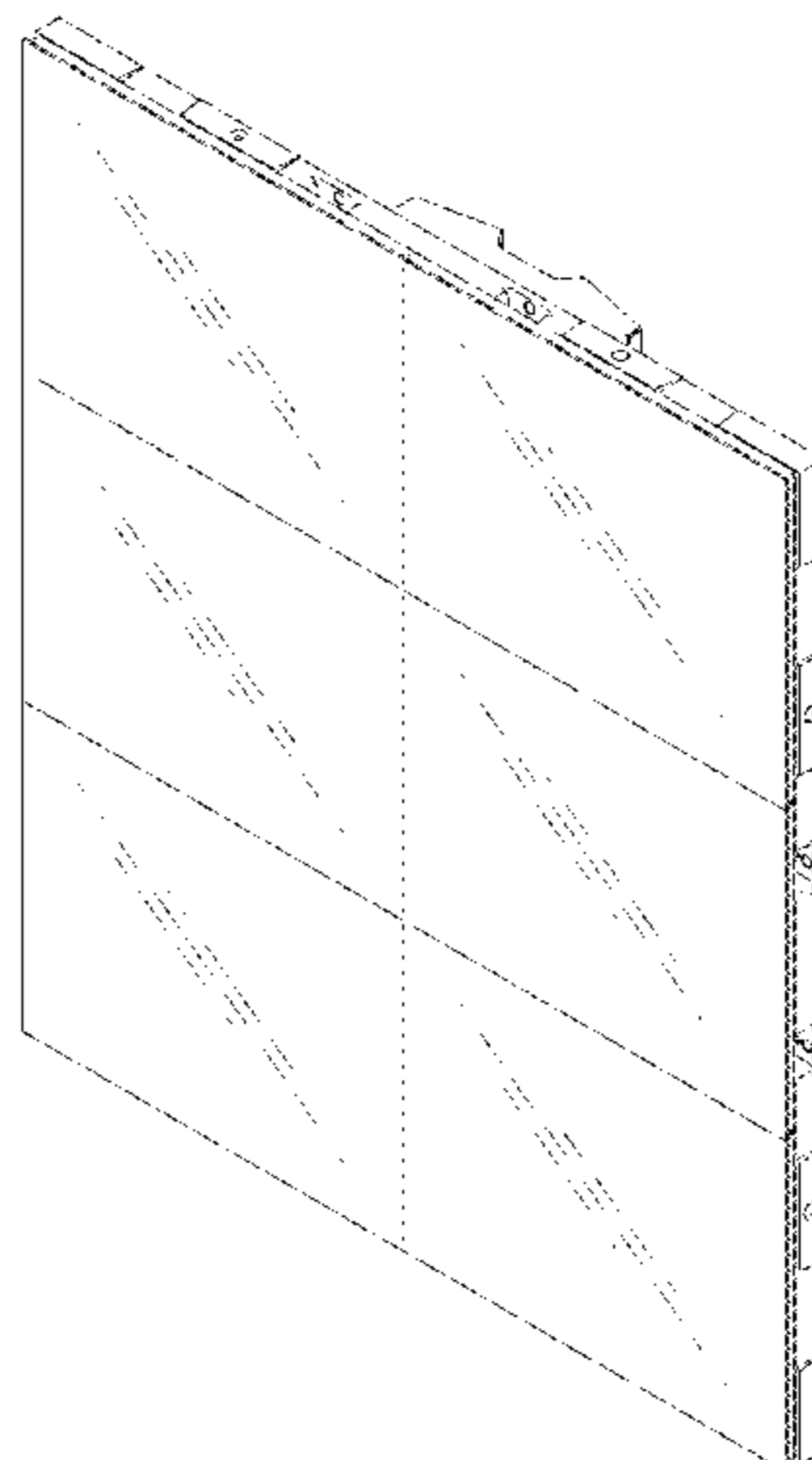

(56)

**References Cited**

U.S. PATENT DOCUMENTS

2008/0280464 A1\* 11/2008 Hsu ..... H01R 13/514  
439/71  
2014/0197123 A1\* 7/2014 McPhillips ..... A63J 1/02  
211/195  
2019/0066894 A1\* 2/2019 Zhu ..... H05K 1/111  
2019/0277377 A1\* 9/2019 Heo ..... H05K 5/0217  
2020/0063767 A1\* 2/2020 Jung ..... B25B 27/02  
2020/0310502 A1\* 10/2020 Cho ..... G06F 1/20

\* cited by examiner

1.1

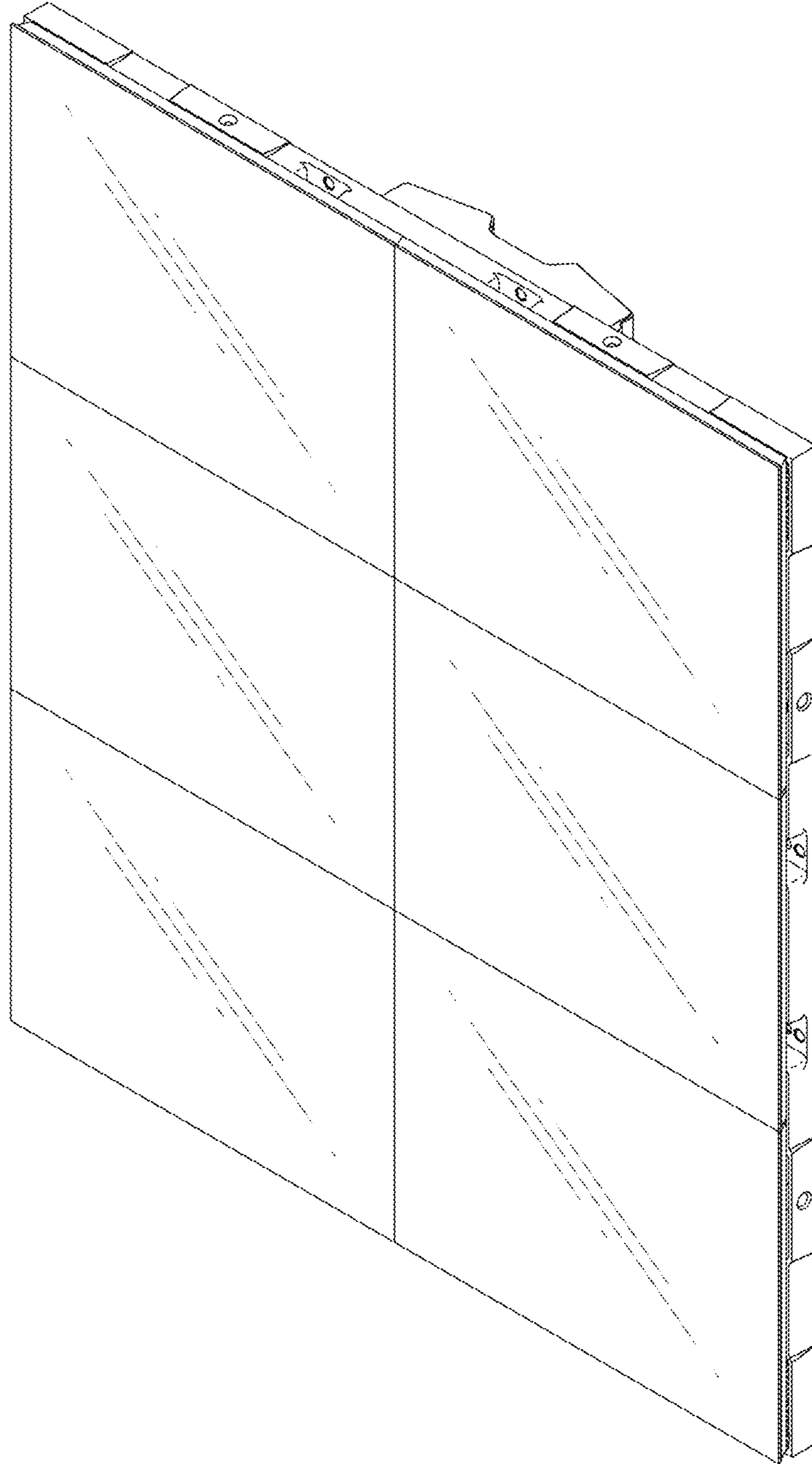



1.2

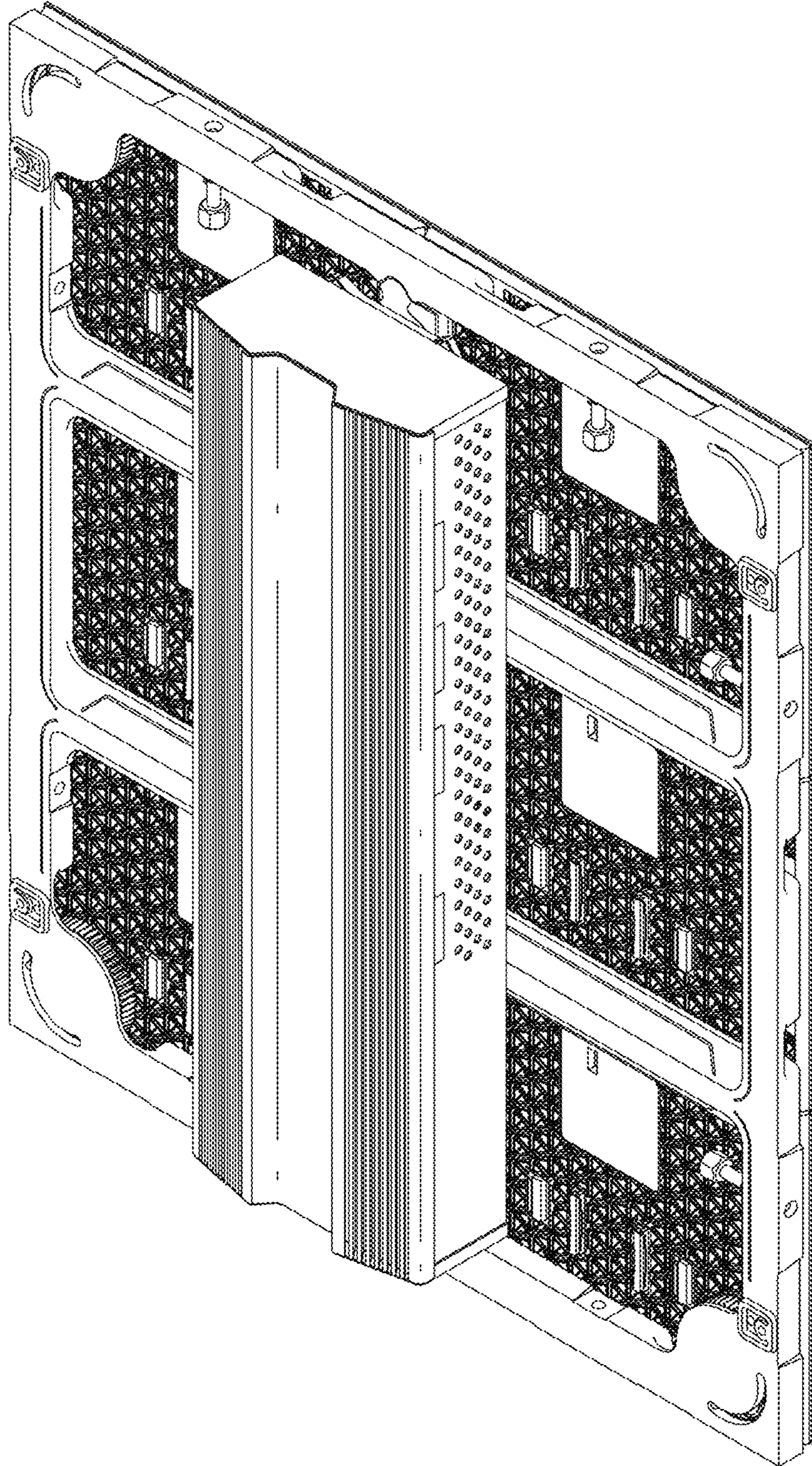

1.3

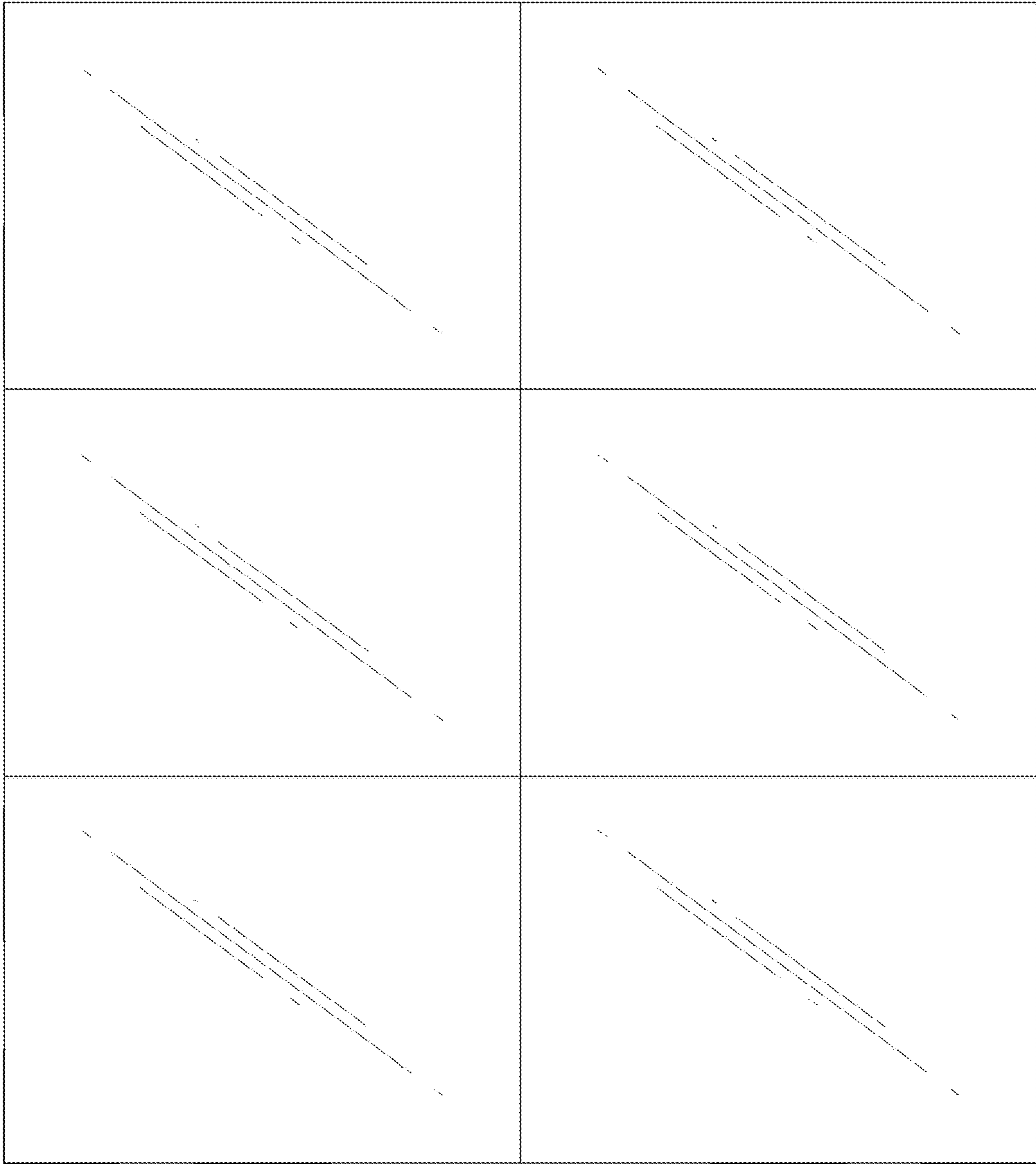



1.4

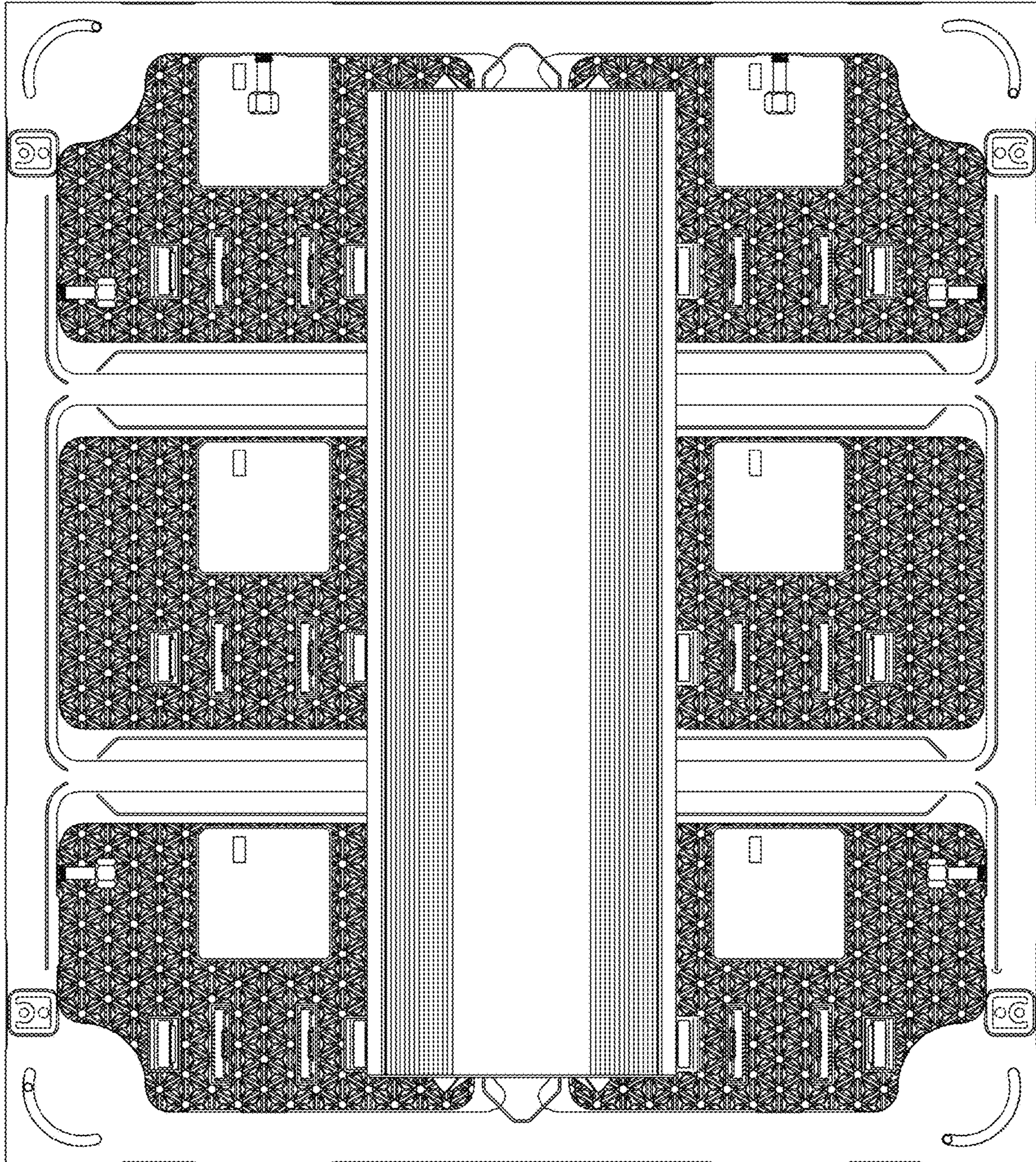



1.5

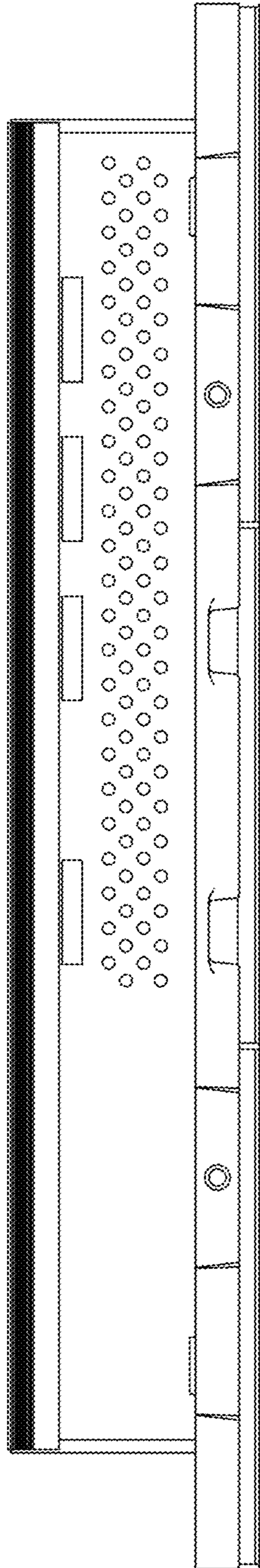

1.6

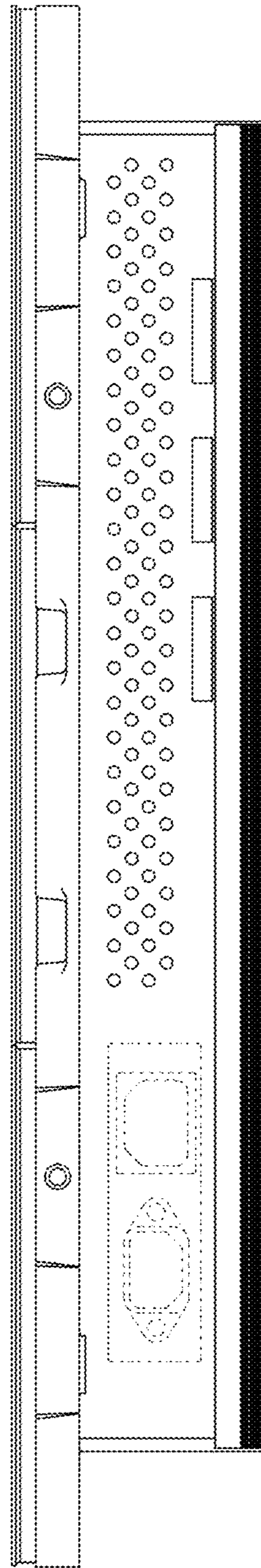



1.7

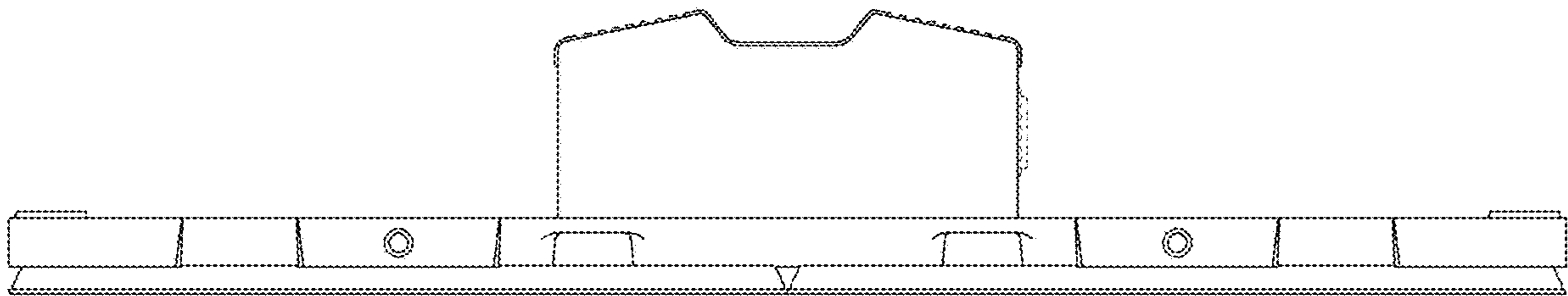

1.8

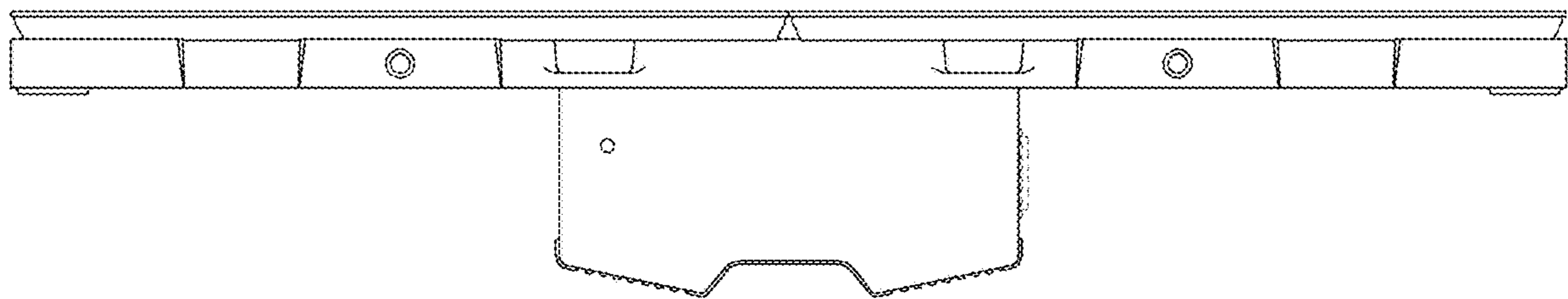



1.9

