

US00D920428S

(12) **United States Design Patent**  
**Casillas**

(10) **Patent No.:** **US D920,428 S**

(45) **Date of Patent:** **\*\* May 25, 2021**

(54) **FOLIO VIDEO BOOK WITH COVER INSERT**

(71) Applicant: **Formulated Lines LLC**, New Port Richey, FL (US)

(72) Inventor: **Kristy Casillas**, New Port Richey, FL (US)

(73) Assignee: **Formulated Lines LLC**, New Port Richey, FL (US)

(\*\*) Term: **15 Years**

(21) Appl. No.: **29/686,000**

(22) Filed: **Apr. 2, 2019**

(51) **LOC (13) Cl.** ..... **19-04**

(52) **U.S. Cl.**

USPC ..... **D19/26**; D14/345; D14/129; D19/2

(58) **Field of Classification Search**

USPC .. D14/126, 129, 130, 132, 133, 138 G, 140, D14/142, 336, 371, 372, 374, 375, 376, D14/380, 382, 383, 448, 451, 496, 345, D14/138 AB; D20/19, 40; D19/1, 2, 26, D19/59, 60, 76, 91, 100; D9/414, 418, D9/420, 433

CPC .... B42D 15/022; B42D 15/04; B42D 15/042; B42D 15/047; B42D 3/00; B42D 3/12; B42D 3/123; B42D 3/18; G09B 5/06; G09B 5/062; G06F 3/147; G09F 1/04; G09F 1/12; H04N 5/772

See application file for complete search history.

(56) **References Cited**

**U.S. PATENT DOCUMENTS**

D271,726 S \* 12/1983 Drake ..... D19/26  
4,636,881 A \* 1/1987 Brefka ..... G09B 5/062  
360/12  
D313,044 S \* 12/1990 Spak ..... D19/26  
D318,859 S \* 8/1991 Hollis ..... D14/345  
D321,175 S \* 10/1991 Tsuchiya ..... D19/60  
D326,446 S \* 5/1992 Wong ..... D14/345  
5,167,508 A \* 12/1992 McTaggart ..... G09B 5/062  
434/317

D334,210 S \* 3/1993 Menchetti ..... D19/2  
D339,139 S \* 9/1993 Jones ..... D14/130  
D344,069 S \* 2/1994 Marmie ..... D14/345  
D344,455 S \* 2/1994 Kornberg ..... D3/271.5  
5,290,190 A \* 3/1994 McClanahan ..... G09B 5/062  
434/317  
D354,483 S \* 1/1995 Yamazaki ..... D14/374  
D362,865 S \* 10/1995 Komuta ..... D14/345  
5,466,158 A \* 11/1995 Smith, III ..... G09B 5/062  
273/236  
D365,362 S \* 12/1995 Warren ..... D19/26  
D378,686 S \* 4/1997 Proctor ..... D14/345  
5,663,748 A \* 9/1997 Huffman ..... G06F 15/0283  
345/173  
D386,521 S \* 11/1997 Eisenbaum ..... D14/345  
D388,463 S \* 12/1997 Sullins ..... D19/83  
5,703,624 A \* 12/1997 van Kruistum ..... G06T 1/00  
345/169  
D391,987 S \* 3/1998 Jambhekar ..... D14/315  
D397,998 S \* 9/1998 Ambroe ..... D19/26  
D399,526 S \* 10/1998 Brady ..... D14/345  
D402,310 S \* 12/1998 Hendricks ..... D14/345  
5,847,698 A \* 12/1998 Reavey ..... G06F 15/0283  
345/173  
D410,028 S \* 5/1999 Fyffe ..... D14/345  
D413,889 S \* 9/1999 Nakano ..... D14/167  
D418,503 S \* 1/2000 Amron ..... D14/203.7  
D418,829 S \* 1/2000 Amron ..... D14/203.7  
D419,986 S \* 2/2000 Amron ..... D14/203.7  
D419,987 S \* 2/2000 Amron ..... D14/496  
D420,662 S \* 2/2000 Amron ..... D14/203.7  
D421,980 S \* 3/2000 Amron ..... D14/496  
D425,558 S \* 5/2000 Tarpenning ..... D14/336  
D425,885 S \* 5/2000 Amron ..... D14/203.7  
D428,004 S \* 7/2000 Colvin ..... D14/345  
D428,018 S \* 7/2000 Amron ..... D14/203.7  
D428,019 S \* 7/2000 Amron ..... D14/203.7  
D429,712 S \* 8/2000 Afshar-Ghochani ..... D14/142  
D429,761 S \* 8/2000 Ward ..... D19/26  
D430,117 S \* 8/2000 Sachs ..... D14/327  
D431,731 S \* 10/2000 Schwab ..... D3/201  
D434,400 S \* 11/2000 Rosen ..... D14/132  
D436,100 S \* 1/2001 Taylor ..... D14/226  
D437,593 S \* 2/2001 Keeler ..... D14/336  
D437,612 S \* 2/2001 Verdicchio ..... D19/26  
6,201,878 B1 \* 3/2001 Azima ..... B42D 15/022  
181/142  
D445,787 S \* 7/2001 Francis ..... D14/345  
D446,809 S \* 8/2001 Parker ..... D19/26  
D448,763 S \* 10/2001 Ikenaga ..... D14/345  
D449,606 S \* 10/2001 Lee ..... D14/345  
D454,870 S \* 3/2002 Lee ..... D14/341

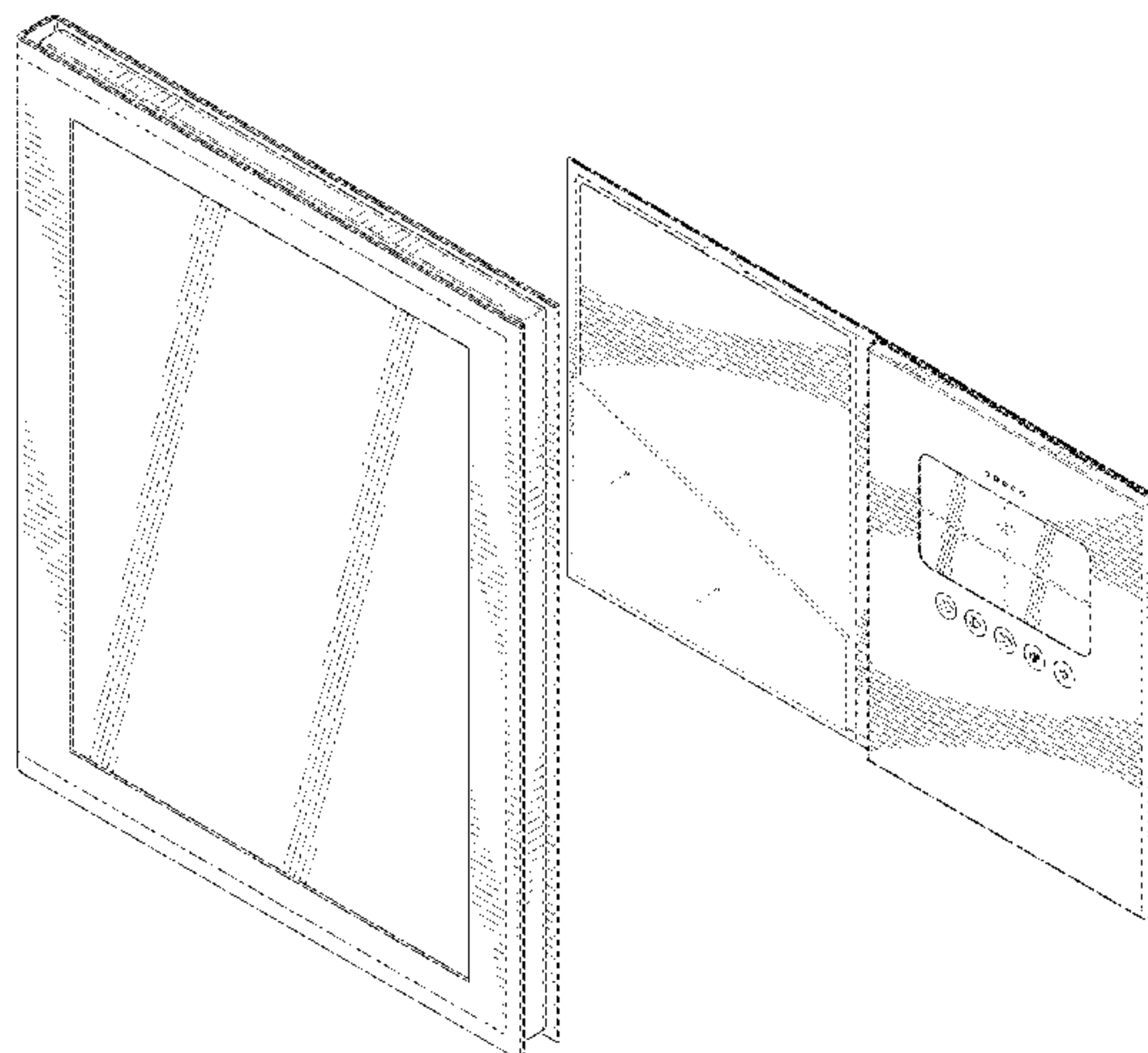



6,437,974 B1 \* 8/2002 Liu ..... G09F 9/35  
 248/917  
 D466,115 S \* 11/2002 Hawkins ..... D14/341  
 D468,349 S \* 1/2003 Scott ..... D19/26  
 6,525,706 B1 \* 2/2003 Rehkemper ..... G09B 5/06  
 345/87  
 6,646,672 B2 \* 11/2003 Feierbach ..... G06F 1/1616  
 348/14.01  
 D487,481 S \* 3/2004 Harris ..... D19/26  
 D489,367 S \* 5/2004 Lynch ..... D14/345  
 D490,807 S \* 6/2004 Murata ..... D14/345  
 D491,942 S \* 6/2004 Takahashi ..... D14/345  
 D494,968 S \* 8/2004 Yonekawa ..... D14/345  
 D495,693 S \* 9/2004 Yonekawa ..... D14/345  
 D499,095 S \* 11/2004 Balarezo ..... D14/345  
 D500,316 S \* 12/2004 Lynch ..... D14/345  
 D507,567 S \* 7/2005 Yonekawa ..... D14/345  
 D517,545 S \* 3/2006 Buckel ..... D14/345  
 D523,853 S \* 6/2006 Ishikawa ..... D14/345  
 D545,359 S \* 6/2007 Bramhall ..... D19/1  
 D547,372 S \* 7/2007 Bharna ..... D19/26  
 D549,283 S \* 8/2007 Bharna ..... D19/27  
 D580,432 S \* 11/2008 Yun ..... D14/345  
 D582,661 S \* 12/2008 Katsof ..... D3/201  
 D589,014 S \* 3/2009 Zhan ..... D14/132  
 D604,730 S \* 11/2009 Shih ..... D14/345  
 D616,929 S \* 6/2010 Krivanek ..... D19/1  
 D618,683 S \* 6/2010 Wilson ..... D14/371  
 D622,513 S \* 8/2010 Tang ..... D14/371  
 D628,569 S \* 12/2010 Guo ..... D14/341  
 D629,458 S \* 12/2010 Clegg ..... D19/1  
 D629,459 S \* 12/2010 Clegg ..... D19/1  
 D629,798 S \* 12/2010 Arie ..... D14/341  
 D629,843 S \* 12/2010 Tartarone ..... D19/26  
 D631,471 S \* 1/2011 Jensen ..... D14/315  
 D632,330 S \* 2/2011 Qiao ..... D19/1  
 D632,734 S \* 2/2011 Qiao ..... D19/1  
 D638,833 S \* 5/2011 Chuang ..... D14/345  
 D642,611 S \* 8/2011 Clegg ..... D19/1  
 D643,060 S \* 8/2011 Clegg ..... D19/1  
 D646,659 S \* 10/2011 Liberatore ..... D14/132  
 D647,559 S \* 10/2011 Clegg ..... D19/1  
 D647,560 S \* 10/2011 Naimi ..... D19/26  
 D649,588 S \* 11/2011 Clegg ..... D19/1  
 D649,589 S \* 11/2011 Clegg ..... D19/1  
 D651,616 S \* 1/2012 Kain ..... D14/496  
 D654,113 S \* 2/2012 Clegg ..... D19/1  
 D655,750 S \* 3/2012 Clegg ..... D19/1  
 D655,751 S \* 3/2012 Sato ..... D19/26  
 D657,417 S \* 4/2012 Naimi ..... D19/26  
 D659,754 S \* 5/2012 Rossiter ..... D19/1  
 D660,909 S \* 5/2012 Clegg ..... D19/1  
 D661,348 S \* 6/2012 Mayer ..... D19/1  
 D661,732 S \* 6/2012 Clegg ..... D19/1  
 D669,480 S \* 10/2012 Piedra ..... D14/440  
 D671,114 S \* 11/2012 Akana ..... D14/341  
 D680,067 S \* 4/2013 Nomi ..... D13/108  
 D681,054 S \* 4/2013 Koh ..... D14/496  
 D684,626 S \* 6/2013 Lam ..... D19/26  
 D685,341 S \* 7/2013 Cetera ..... D14/203.4  
 D685,342 S \* 7/2013 Cetera ..... D14/203.4  
 D690,275 S \* 9/2013 Seidl ..... D13/162  
 D691,653 S \* 10/2013 Benadon ..... D19/26  
 D699,181 S \* 2/2014 Hung ..... D13/108  
 D719,717 S \* 12/2014 Schweitzer ..... D1/121  
 D720,005 S \* 12/2014 Cofone ..... D19/26  
 D748,629 S \* 2/2016 Brown ..... D14/383  
 D749,055 S \* 2/2016 Lee ..... D14/204  
 D762,262 S \* 7/2016 Richardson ..... D19/1  
 D765,779 S \* 9/2016 Deckerd ..... D19/1  
 D770,448 S \* 11/2016 Endo ..... D14/371  
 9,491,876 B2 \* 11/2016 Weber ..... G06F 1/1616  
 D780,844 S \* 3/2017 Frommelt ..... D19/26  
 D790,007 S \* 6/2017 Knight ..... D19/1  
 D802,661 S \* 11/2017 Salatandre ..... D19/2  
 D809,470 S \* 2/2018 Dancsecs ..... D14/132  
 D809,471 S \* 2/2018 Dancsecs ..... D14/132  
 D813,312 S \* 3/2018 Mahbubani ..... D20/40  
 D822,106 S \* 7/2018 Mahbubani ..... D19/1

D822,658 S \* 7/2018 Okuley ..... D14/345  
 D850,440 S \* 6/2019 Gentle ..... D14/336  
 D859,400 S \* 9/2019 Konishi ..... D14/345  
 D862,456 S \* 10/2019 Nishizawa ..... D14/341  
 D882,392 S \* 4/2020 Haines ..... D9/420  
 D886,820 S \* 6/2020 Nishizawa ..... D14/345  
 D887,415 S \* 6/2020 Claudepierre ..... D14/440  
 D893,609 S \* 8/2020 Schiumarini ..... D19/26  
 2002/0054073 A1 \* 5/2002 Yuen ..... G06F 16/685  
 715/727  
 2005/0186547 A1 \* 8/2005 Yang ..... G09B 5/062  
 434/308  
 2005/0271354 A1 \* 12/2005 Yeh ..... H04N 5/772  
 386/219  
 2006/0134591 A1 \* 6/2006 Karat ..... B42D 15/022  
 434/308  
 2008/0289230 A1 \* 11/2008 Mandelbaum ..... B42D 15/022  
 40/124.01  
 2009/0211126 A1 \* 8/2009 Oh ..... G09F 1/04  
 40/124.03  
 2011/0066945 A1 \* 3/2011 Lee ..... H04N 5/772  
 715/719  
 2011/0214319 A1 \* 9/2011 Hsu ..... G09F 1/04  
 40/124.09  
 2011/0244438 A1 \* 10/2011 Legrand ..... G09B 5/062  
 434/317  
 2014/0041264 A1 \* 2/2014 Chambers ..... B42D 15/022  
 40/124.06  
 2017/0297360 A1 \* 10/2017 Milon ..... B42D 15/022

\* cited by examiner

*Primary Examiner* — Marie D. Fast Horse  
 (74) *Attorney, Agent, or Firm* — Larson & Larson, P.A.;  
 Frank Liebenow; Justin P. Miller

(57) **CLAIM**

The ornamental design for a folio video book with cover insert, as shown and described.

**DESCRIPTION**

FIG. 1 is a perspective view of a folio video book with cover insert showing my new design in a closed configuration; FIG. 2 is a front elevation view thereof in the closed configuration; FIG. 3 is a rear elevation view thereof in the closed configuration; FIG. 4 is a right side elevational view thereof in the closed configuration; FIG. 5 is a left side elevational view thereof in the closed configuration; FIG. 6 is a bottom plan view thereof in the closed configuration; FIG. 7 is a top plan view thereof in the closed configuration; FIG. 8 is an inside perspective view thereof in an open configuration; FIG. 9 is an inside front elevation view thereof in the open configuration; FIG. 10 is a rear elevation view thereof in the open configuration; FIG. 11 is a right side elevational view thereof in the open configuration; FIG. 12 is a left side elevational view thereof in the open configuration; FIG. 13 is a bottom plan view thereof in the open configuration; FIG. 14 is a top plan view thereof in the open configuration;

FIG. **15** is an inside perspective view of a second embodiment of my claimed design in the open configuration the difference consisting of disclaiming the video controls and speaker holes;

FIG. **16** is an inside front elevation view thereof in the open configuration;

FIG. **17** is a rear elevation view thereof in the open configuration;

FIG. **18** is a right side elevational view thereof in the open configuration;

FIG. **19** is a left side elevational view thereof in the open configuration;

FIG. **20** is a bottom plan view thereof in the open configuration; and,

FIG. **21** is a top plan view thereof in the open configuration. The folio video book with cover insert shows a rounded corner rectangular interior display with symbolic breaks in its height and width. The appearance of any portion of the article in between these broken lines, including the broken lines themselves, forms no part of the claimed design. All other broken lines depict portions of the folio video book with cover insert that form no part of the claimed design.

**1 Claim, 15 Drawing Sheets**



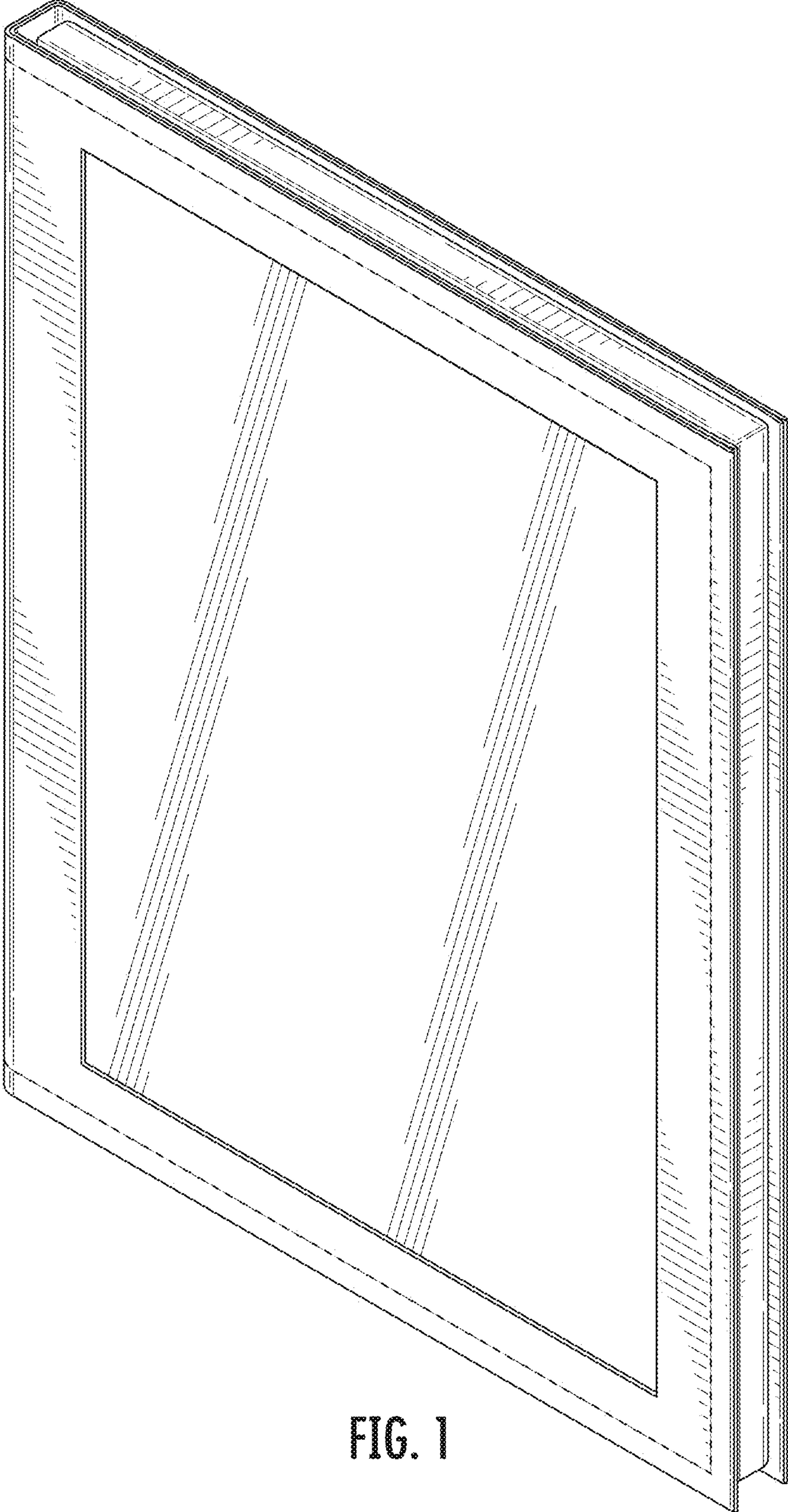

FIG. 1

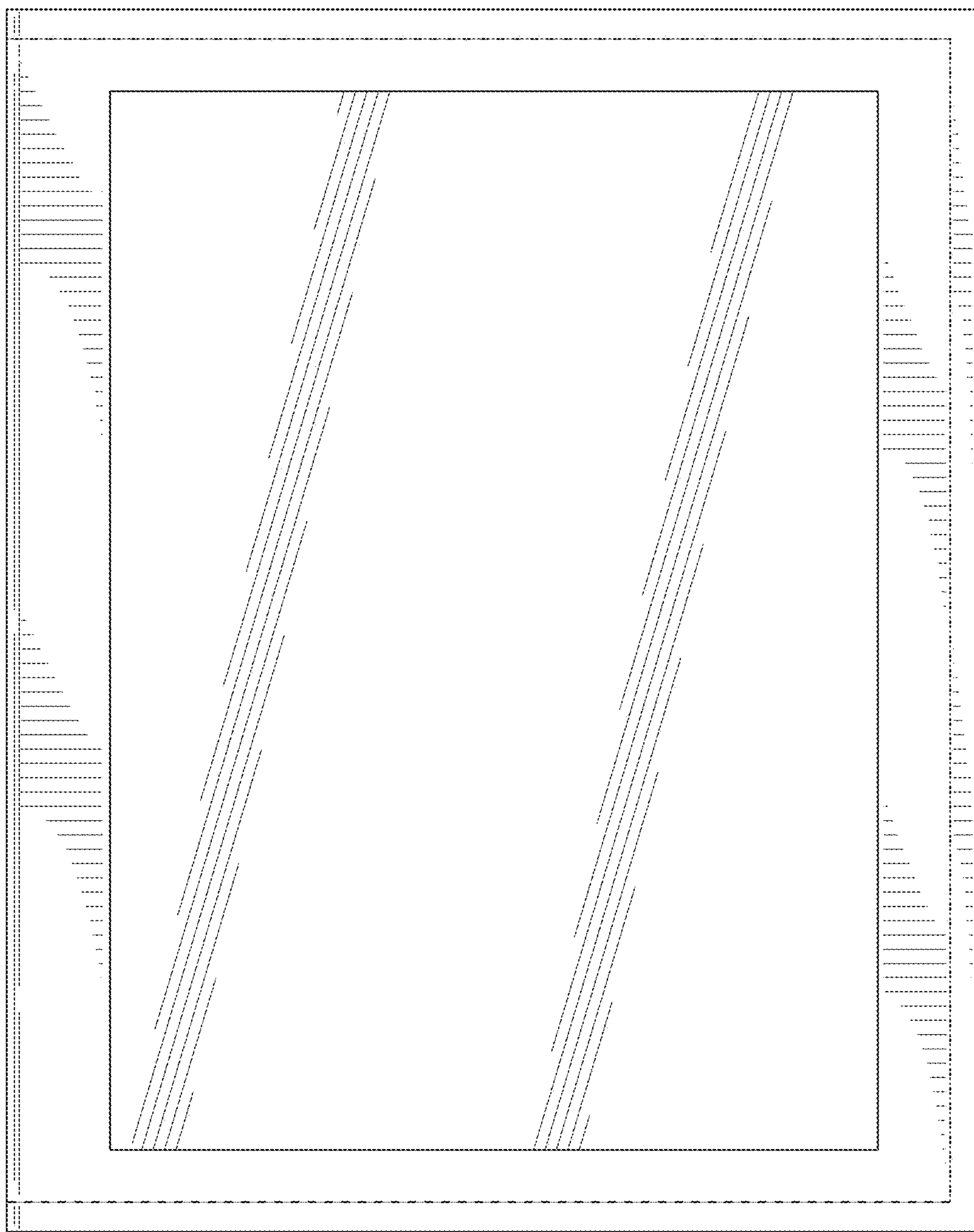

FIG. 2

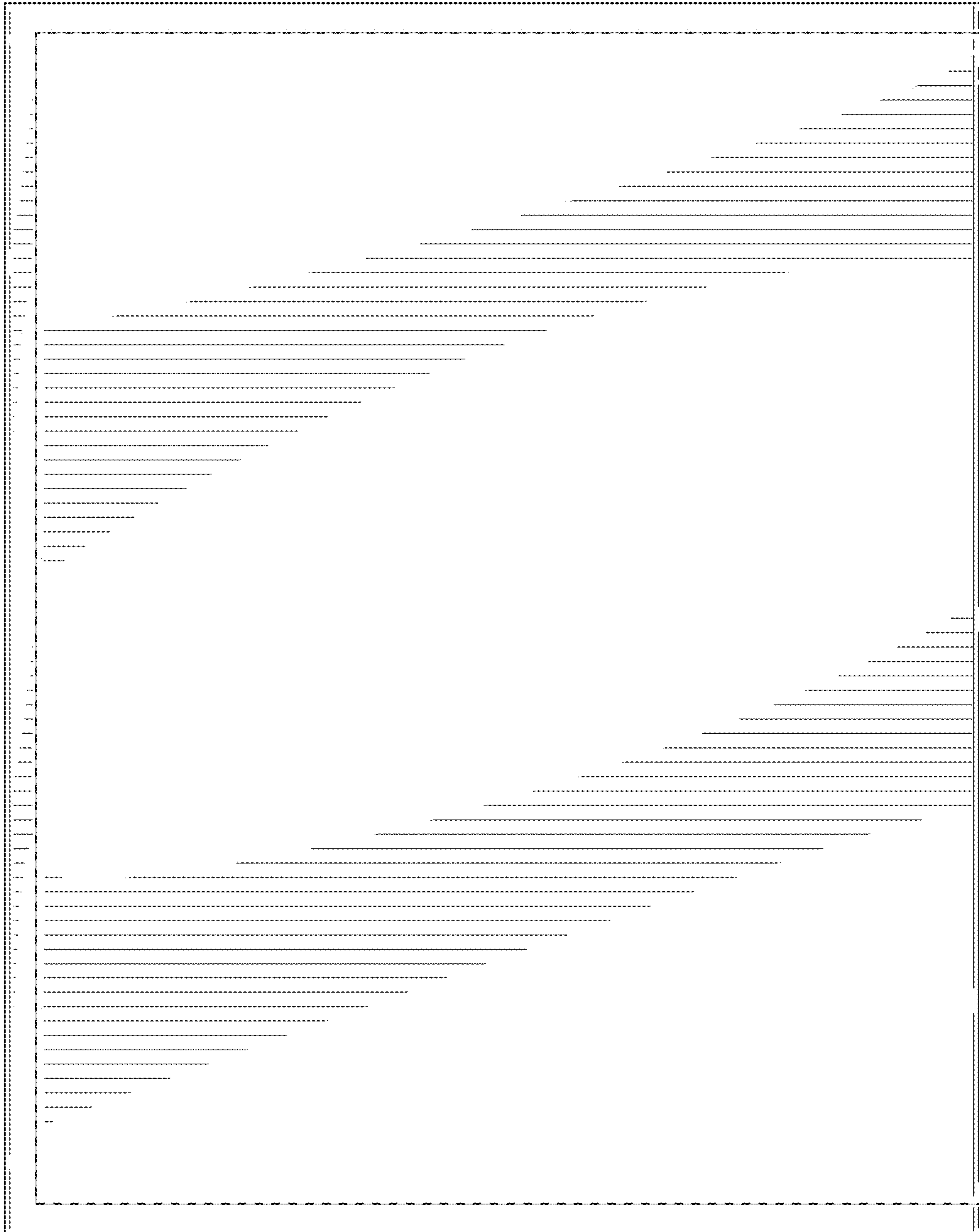

FIG. 3

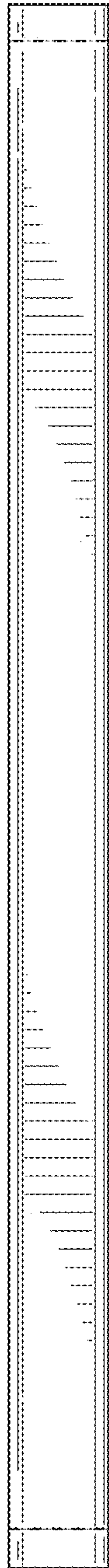

FIG. 4

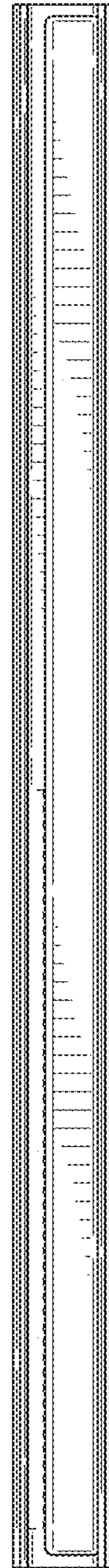

FIG. 5

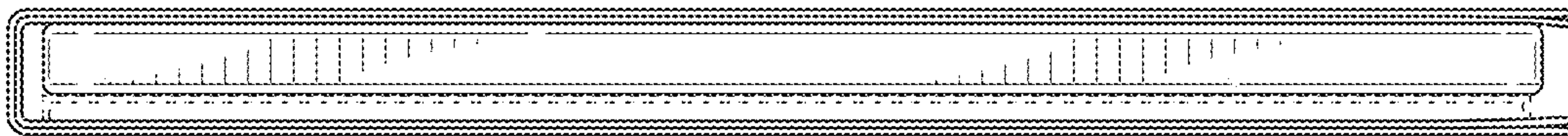

FIG. 6

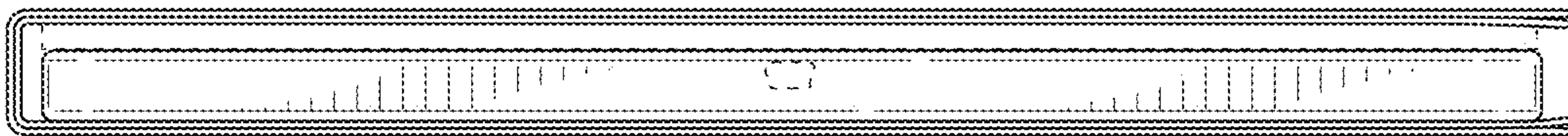

FIG. 7



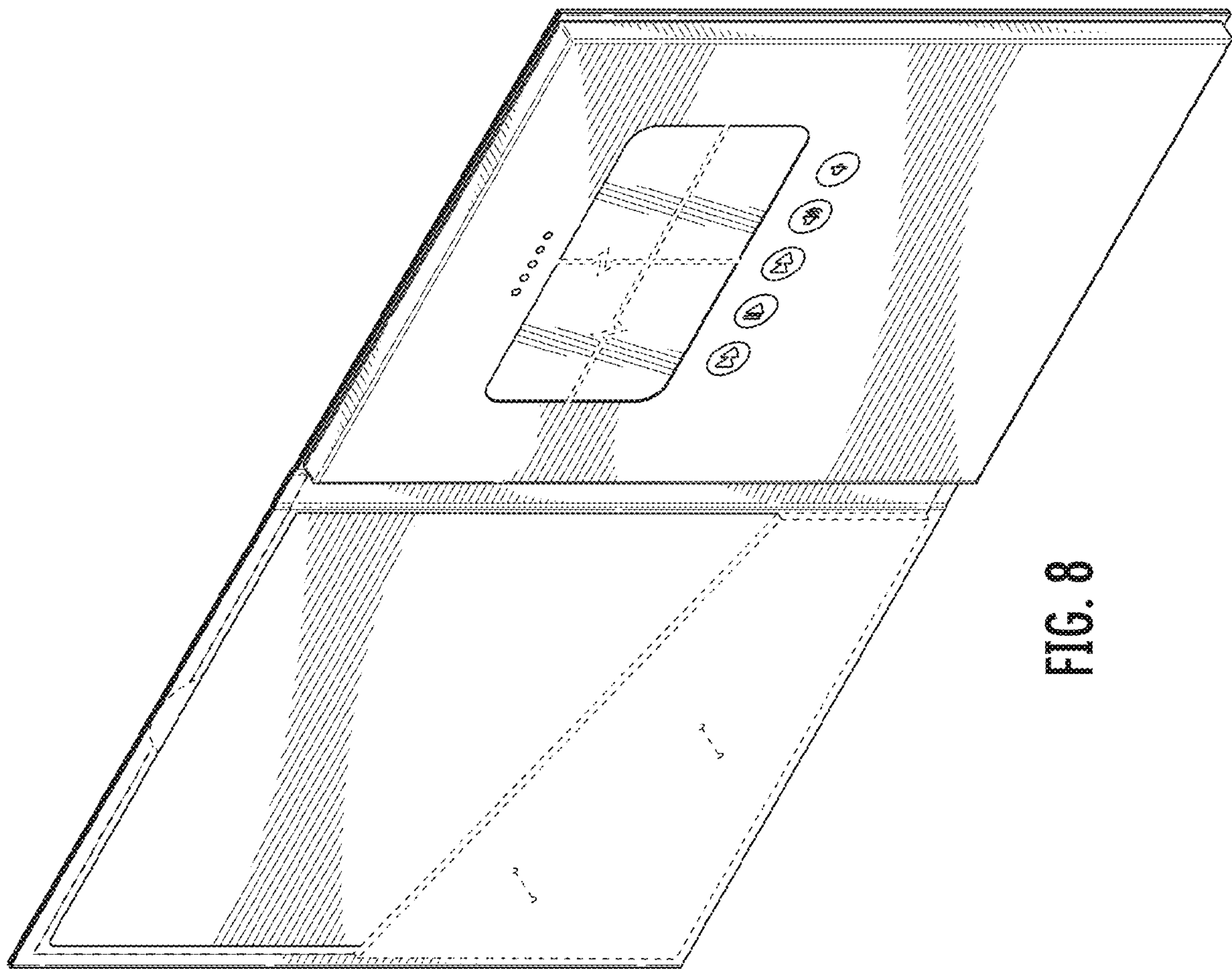

FIG. 8

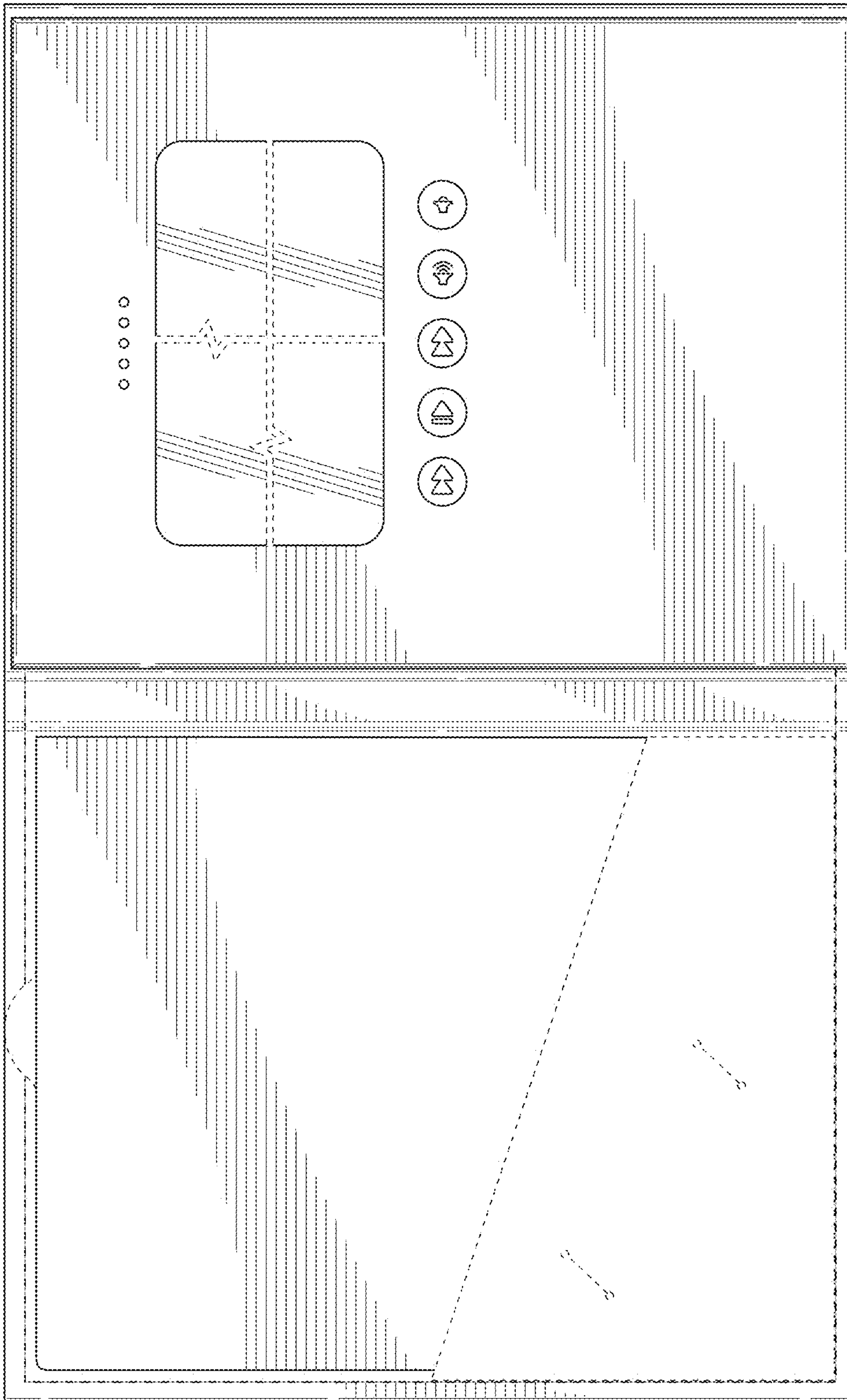

FIG. 9

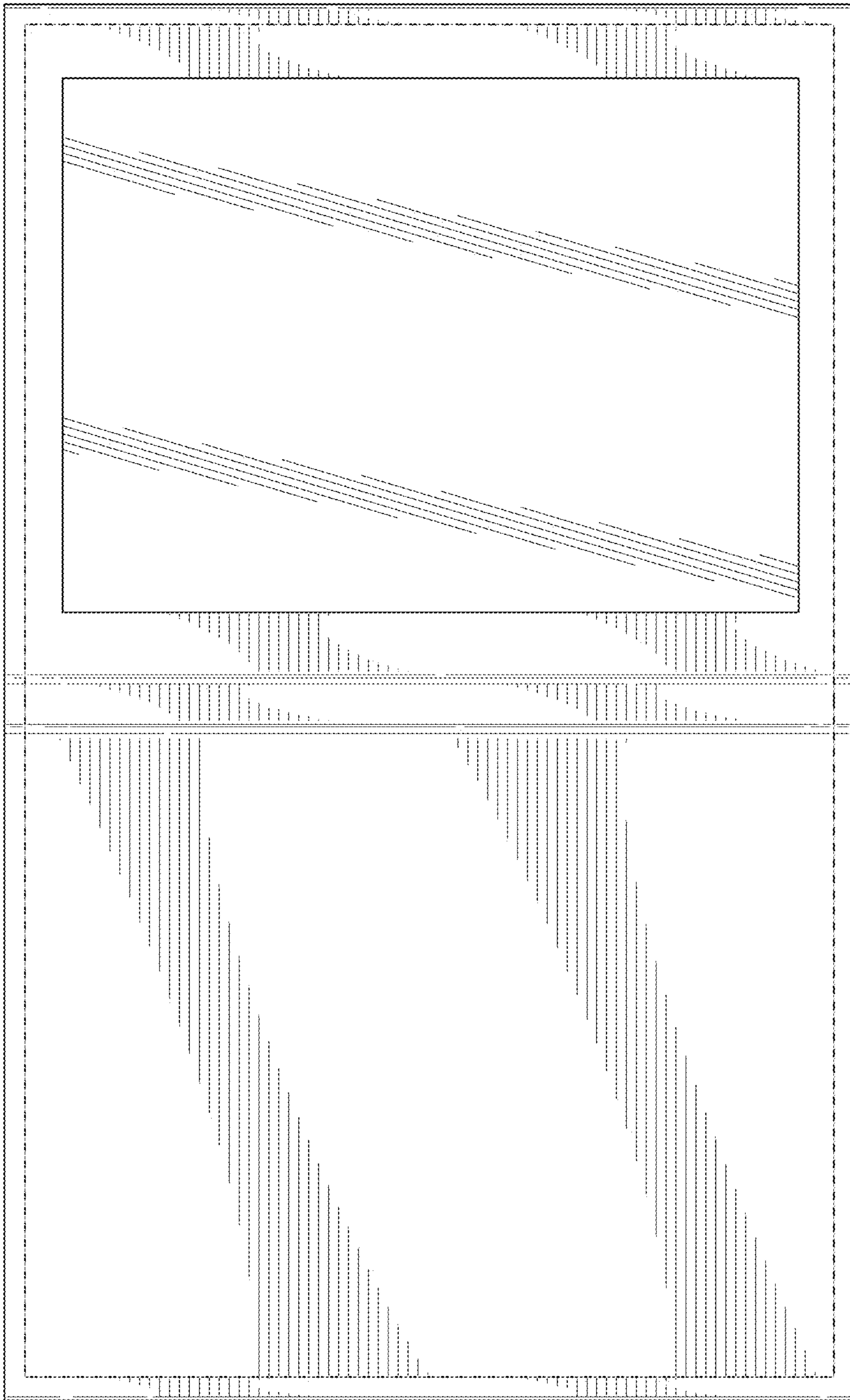

FIG. 10





FIG. 11

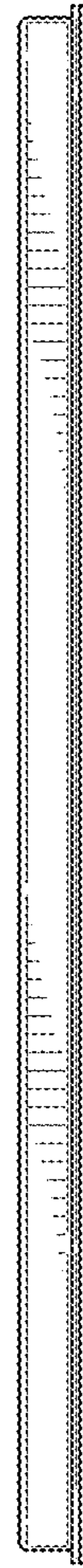

FIG. 12

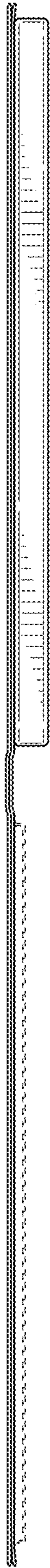

FIG. 13

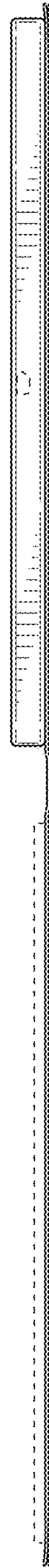
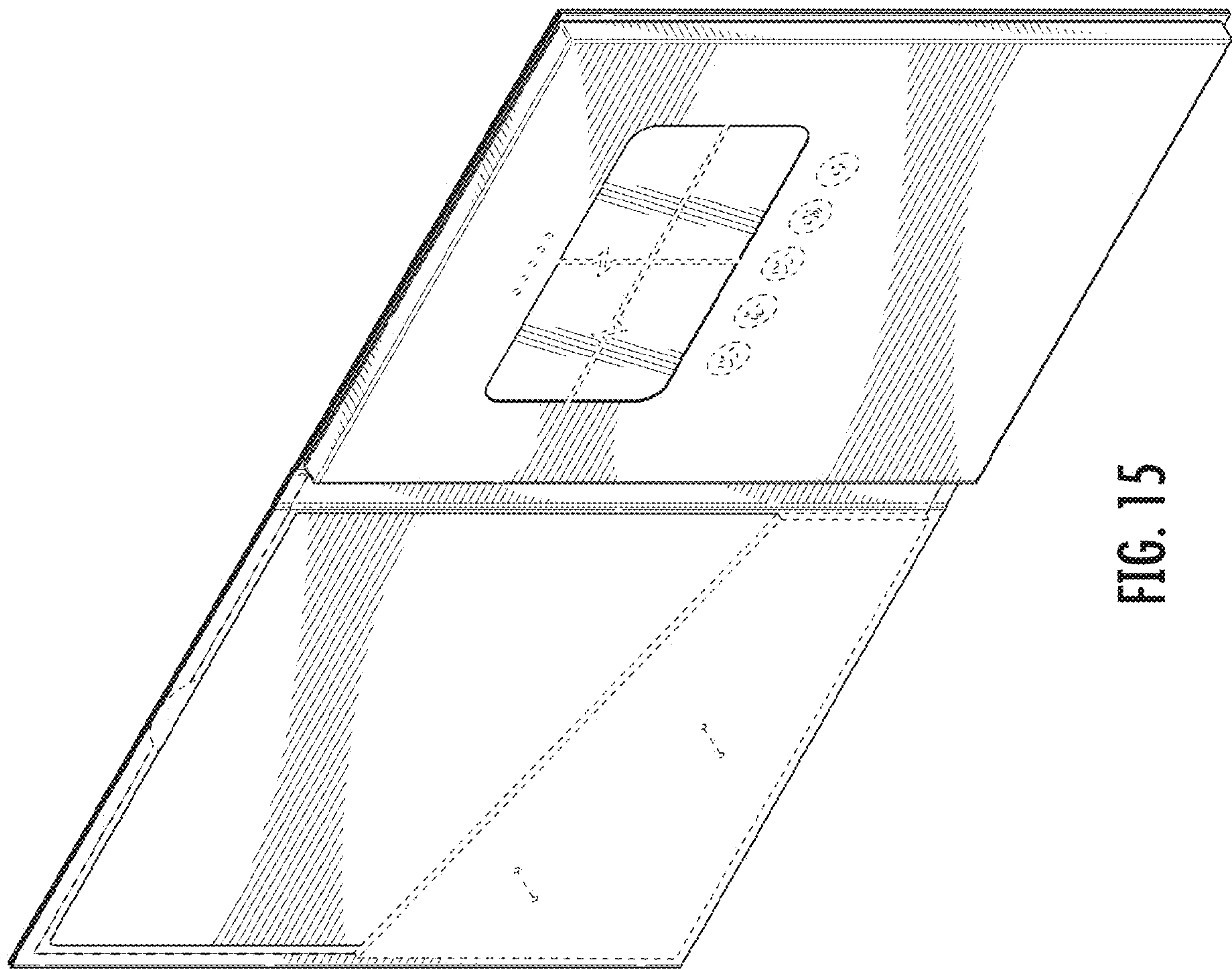

FIG. 14





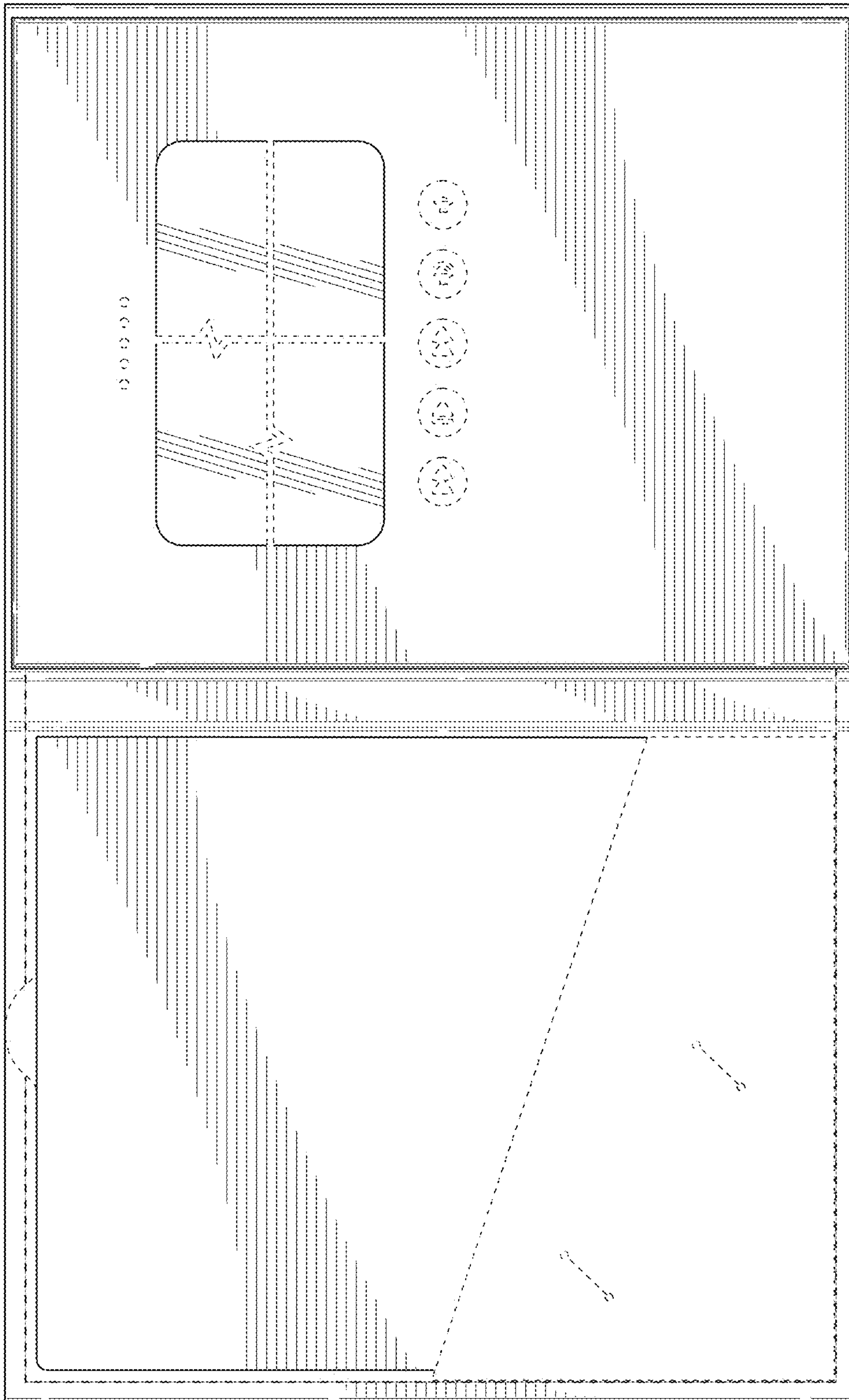

FIG. 16



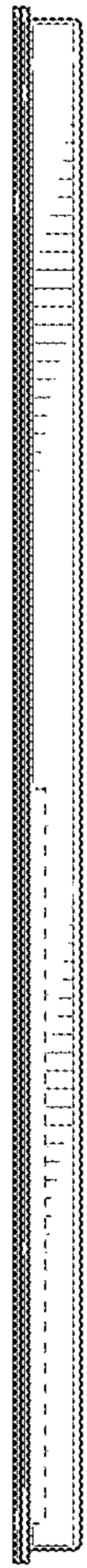

FIG. 18

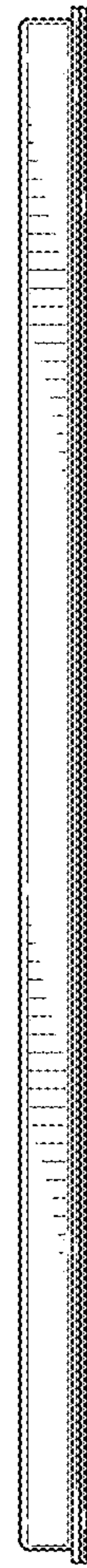

FIG. 19



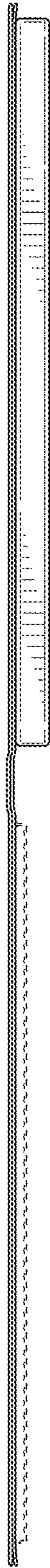

FIG. 20



FIG. 21