

US00D920178S

(12) **United States Design Patent** (10) **Patent No.:** **US D920,178 S**
Choi et al. (45) **Date of Patent:** **** May 25, 2021**

(54) **VEHICLE GRILLE**
 (71) Applicant: **GM GLOBAL TECHNOLOGY OPERATIONS LLC**, Detroit, MI (US)
 (72) Inventors: **Myeongseon Choi**, Incheon (KR);
Jaewook Jung, Gimpo-si (KR);
Youngho Jung, Gimpo-si (KR)
 (73) Assignee: **GM GLOBAL TECHNOLOGY OPERATIONS LLC**, Detroit, MI (US)
 (**) Term: **15 Years**
 (21) Appl. No.: **29/705,287**
 (22) Filed: **Sep. 11, 2019**
 (30) **Foreign Application Priority Data**

D603,755 S 11/2009 Peters
 D604,203 S 11/2009 O'Donnell
 D605,082 S 12/2009 Munson
 D605,083 S 12/2009 Manoogian, II et al.
 D605,977 S 12/2009 Zipfel et al.
 D605,978 S 12/2009 Wolff et al.
 D608,249 S 1/2010 Peters
 D608,690 S 1/2010 Folden et al.
 D608,691 S 1/2010 Zak, Jr. et al.
 D609,608 S 2/2010 Boniface et al.
 D611,387 S 3/2010 Thompson et al.
 D611,879 S 3/2010 Kim et al.
 D612,297 S 3/2010 Peters et al.
 D613,645 S 4/2010 Song et al.
 D615,458 S 5/2010 Thompson et al.
 D618,595 S 6/2010 Ware et al.
 D623,090 S 9/2010 Cox et al.
 D627,262 S 11/2010 Ikeda et al.
 D635,488 S 4/2011 Phipps
 D644,147 S 8/2011 Suh et al.
 D644,567 S 9/2011 Kozub
 D657,718 S 4/2012 Zipfel et al.
 D659,052 S 5/2012 Ware et al.

(Continued)

Mar. 27, 2019 (KR) 30-2019-0013969

(51) **LOC (13) Cl.** **12-16**
 (52) **U.S. Cl.**
 USPC **D12/163**
 (58) **Field of Classification Search**
 USPC D12/163, 196, 86, 90-92, 169, 190, 98,
 D12/164; 293/102, 113, 115, 117, 120,
 293/193.11; 296/180.1, 180.2; 180/68.1,
 180/68.6
 CPC B60R 19/52; B60K 11/08; B62D 25/08;
 B62B 9/16
 See application file for complete search history.

Primary Examiner — Melody N Brown

(57) **CLAIM**

The ornamental design for a vehicle grille, as shown and described.

DESCRIPTION

FIG. 1 is a front and left side perspective view of a vehicle grille showing our new design;
 FIG. 2 is a front elevation view thereof;
 FIG. 3 is a left side elevation view thereof;
 FIG. 4 is a right side elevation view thereof;
 FIG. 5 is a top plan view thereof;
 FIG. 6 is a rear elevation view thereof; and,
 FIG. 7 is a bottom plan view thereof.
 The broken lines in the drawings depict portions of the vehicle grille that form no part of the claimed design.

1 Claim, 7 Drawing Sheets

(56) **References Cited**
 U.S. PATENT DOCUMENTS
 D570,742 S 6/2008 Takagi et al.
 D592,105 S 5/2009 Dean et al.
 D597,447 S 8/2009 Folden
 D600,595 S 9/2009 Nakamura et al.
 D601,925 S 10/2009 O'Donnell

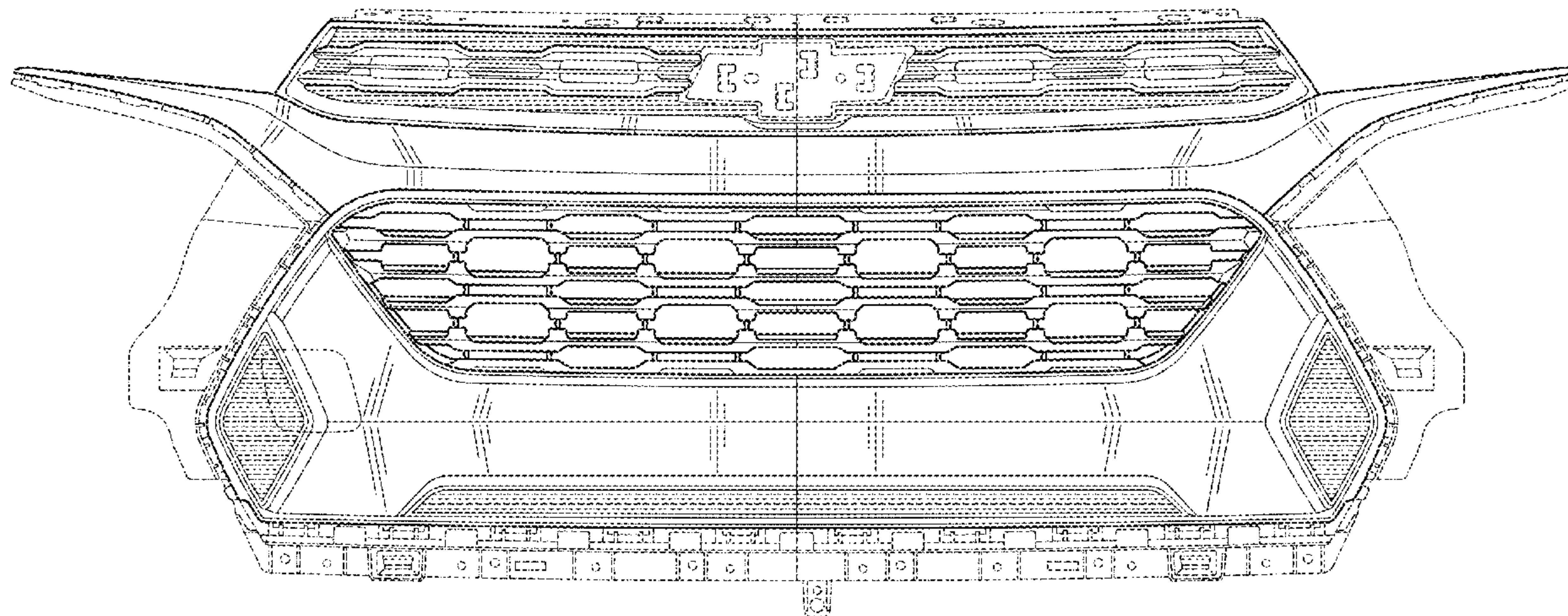

(56)

References Cited

U.S. PATENT DOCUMENTS

D659,053 S	5/2012	Ware et al.	D753,032 S	4/2016	Smith et al.
D668,182 S	10/2012	Barba Franco et al.	D753,033 S	4/2016	Thole et al.
D668,183 S	10/2012	Smart	D753,034 S	4/2016	Thole et al.
D678,820 S	3/2013	Son et al.	D753,035 S	4/2016	Boniface et al.
D678,821 S	3/2013	Ikeda et al.	D753,559 S	4/2016	McMahan et al.
D680,909 S	4/2013	Munson et al.	D753,560 S	4/2016	McMahan et al.
D680,910 S	4/2013	David	D753,567 S	4/2016	Boniface et al.
D684,899 S	6/2013	Baker	D754,571 S	4/2016	Boniface et al.
D686,536 S	7/2013	McCabe et al.	D754,572 S	4/2016	McMahan et al.
D692,798 S	11/2013	Thurber	D755,088 S	5/2016	McMahan et al.
D692,799 S	11/2013	Smith et al.	D756,869 S	5/2016	McMahan et al.
D696,157 S	12/2013	Loeb	D758,271 S	6/2016	McMahan et al.
D699,629 S	2/2014	Ikeda et al.	D764,975 S	8/2016	Aengenheyster
D700,871 S	3/2014	O'Donnell et al.	D764,976 S	8/2016	Aengenheyster
D703,103 S	4/2014	Lee	D767,449 S	9/2016	Pevovar et al.
D704,103 S	5/2014	Mack et al.	D767,450 S	9/2016	Lee et al.
D705,132 S	5/2014	Ware et al.	D767,451 S	9/2016	Kozub et al.
D705,699 S	5/2014	Ware et al.	D767,454 S	9/2016	McMahan et al.
D713,298 S	9/2014	Dyson	D767,458 S	9/2016	Kim
D713,764 S	9/2014	Ferlazzo et al.	D767,459 S	9/2016	Kim
D716,696 S	11/2014	Thole et al.	D767,460 S	9/2016	Kozub et al.
D716,706 S	11/2014	Thole et al.	D767,461 S	9/2016	Kozub et al.
D716,709 S	11/2014	Thole et al.	D771,528 S	11/2016	Smith et al.
D717,696 S	11/2014	Thole et al.	D771,529 S	11/2016	Thole et al.
D718,189 S	11/2014	Krieg et al.	D771,532 S	11/2016	Kapitonov
D718,683 S	12/2014	Thole et al.	D771,533 S	11/2016	Kapitonov
D722,282 S	2/2015	Loeb	D772,766 S	11/2016	Kozub et al.
D722,533 S	2/2015	Thole et al.	D772,767 S	11/2016	Kim
D722,534 S	2/2015	Munson et al.	D773,084 S	11/2016	Kapitonov
D724,510 S	3/2015	McMahan et al.	D773,086 S	11/2016	McCabe et al.
D725,001 S	3/2015	McMahan et al.	D774,226 S	12/2016	McCabe et al.
D726,591 S	4/2015	Jacob	D775,003 S	12/2016	Pevovar et al.
D730,776 S	6/2015	Smart	D775,007 S	12/2016	Thole et al.
D730,783 S	6/2015	Henriques et al.	D775,010 S	12/2016	Kim et al.
D732,427 S	6/2015	Loeb	D775,049 S	12/2016	Scheer et al.
D732,429 S	6/2015	Loeb	D775,549 S	1/2017	Karras
D732,430 S	6/2015	Loeb	D775,554 S	1/2017	Kapitonov
D732,431 S	6/2015	Loeb	D776,020 S	1/2017	Kapitonov
D732,432 S	6/2015	Aengenheyster	D776,581 S	1/2017	Pevovar et al.
D732,433 S	6/2015	Aengenheyster	D776,583 S	1/2017	Scheer et al.
D732,435 S	6/2015	Mackay	D776,841 S	1/2017	Kozub et al.
D733,002 S	6/2015	Loeb	D776,843 S	1/2017	McCabe et al.
D735,611 S	8/2015	Aengenheyster	D776,846 S	1/2017	Willett et al.
D735,627 S	8/2015	Smith	D777,359 S	1/2017	Kozub et al.
D736,451 S	8/2015	Smith	D777,360 S	1/2017	Kozub et al.
D739,306 S	9/2015	McMahan et al.	D777,361 S	1/2017	Kozub et al.
D739,317 S	9/2015	McMahan et al.	D777,604 S	1/2017	McNerney
D741,223 S	10/2015	Kim et al.	D777,605 S	1/2017	Ferlazzo et al.
D743,309 S	11/2015	Thole et al.	D777,620 S	1/2017	Pevovar et al.
D743,313 S	11/2015	Smith et al.	D777,621 S	1/2017	Kim
D743,314 S	11/2015	Thole et al.	D777,622 S	1/2017	Kozub et al.
D743,857 S	11/2015	McMahan et al.	D777,628 S	1/2017	Kozub et al.
D744,158 S	11/2015	Willett et al.	D777,955 S	1/2017	Willett et al.
D745,086 S	12/2015	Finos et al.	D778,212 S	2/2017	Kozub et al.
D745,719 S	12/2015	Boniface et al.	D778,215 S	2/2017	Kozub et al.
D745,725 S	12/2015	McMahan et al.	D780,064 S	2/2017	Smith et al.
D745,726 S	12/2015	McMahan et al.	D780,067 S	2/2017	Zipfel et al.
D745,837 S	12/2015	Smith et al.	D780,068 S	2/2017	Whitla et al.
D746,726 S	1/2016	Smith et al.	D780,077 S	2/2017	Kim et al.
D746,727 S	1/2016	Smith et al.	D780,081 S	2/2017	Lee
D746,728 S	1/2016	Smith et al.	D780,084 S	2/2017	Scheer et al.
D746,729 S	1/2016	Boniface et al.	D780,631 S	3/2017	Kozub et al.
D746,730 S	1/2016	Kim et al.	D780,644 S	3/2017	Kim et al.
D747,514 S	1/2016	McMahan et al.	D781,184 S	3/2017	Thole et al.
D747,515 S	1/2016	McMahan et al.	D781,192 S	3/2017	Kozub et al.
D747,819 S	1/2016	Thole et al.	D782,379 S	3/2017	Wassell
D749,021 S	2/2016	Boniface et al.	D783,482 S	4/2017	Smith et al.
D749,026 S	2/2016	Smith et al.	D784,213 S	4/2017	Karras
D749,027 S	2/2016	McMahan et al.	D784,223 S	4/2017	Lee
D749,246 S	2/2016	Thole et al.	D784,226 S	4/2017	Cheng
D749,249 S	2/2016	Thole et al.	D784,579 S	4/2017	Cheng et al.
D749,250 S	2/2016	Thole et al.	D784,877 S	4/2017	Lee
D749,985 S	2/2016	Kozub et al.	D784,886 S	4/2017	Smith et al.
D749,997 S	2/2016	McMahan et al.	D785,521 S	5/2017	Smith et al.
D750,001 S	2/2016	Thole et al.	D786,149 S	5/2017	Pevovar et al.
			D786,743 S	5/2017	Smith et al.
			D786,750 S	5/2017	Lee
			D787,446 S	5/2017	Cockerill
			D787,984 S	5/2017	Fang

(56)

References Cited

U.S. PATENT DOCUMENTS

D787,988 S	5/2017	Lee	D803,727 S	11/2017	Noone et al.
D787,989 S	5/2017	Kozub et al.	D803,731 S	11/2017	Zipfel
D787,990 S	5/2017	Kozub et al.	D804,370 S	12/2017	Kozub et al.
D787,992 S	5/2017	Lee	D804,371 S	12/2017	Whitla et al.
D787,993 S	5/2017	McCabe et al.	D804,372 S	12/2017	Kozub
D788,001 S	5/2017	Lee	D804,378 S	12/2017	Perkins
D788,641 S	6/2017	Arnold	D804,379 S	12/2017	McMahan
D788,644 S	6/2017	Mueller	D805,006 S	12/2017	Nakamura
D788,645 S	6/2017	Mueller	D805,013 S	12/2017	Whitla
D789,250 S	6/2017	Arnold	D805,014 S	12/2017	Zipfel
D789,260 S	6/2017	Smith	D805,441 S	12/2017	Karras
D789,575 S	6/2017	Willett	D805,964 S	12/2017	Whitla
D789,841 S	6/2017	Lee	D805,965 S	12/2017	Davis
D789,849 S	6/2017	Lee	D805,966 S	12/2017	Perkins
D791,018 S	7/2017	Mylenek	D805,985 S	12/2017	Nakamura
D791,644 S	7/2017	Fang	D807,232 S	1/2018	Bailie
D792,290 S	7/2017	Smith et al.	D807,239 S	1/2018	Perkins
D792,293 S	7/2017	McCabe et al.	D807,240 S	1/2018	Perkins
D792,294 S	7/2017	McCabe et al.	D807,241 S	1/2018	Perkins
D792,295 S	7/2017	McCabe et al.	D809,442 S	2/2018	Zipfel et al.
D792,815 S	7/2017	Kozub	D811,269 S	2/2018	Thompson et al.
D792,816 S	7/2017	Kozub	D811,942 S	3/2018	Jacob
D793,290 S	8/2017	Kozub	D811,957 S	3/2018	Whitla et al.
D793,292 S	8/2017	Lee	D811,958 S	3/2018	Zipfel et al.
D793,293 S	8/2017	Lee et al.	D811,959 S	3/2018	Perkins
D793,294 S	8/2017	Lee	D811,960 S	3/2018	Nakamura
D793,295 S	8/2017	McCabe et al.	D811,961 S	3/2018	Sullivan
D793,296 S	8/2017	Smith et al.	D811,962 S	3/2018	Sullivan
D793,297 S	8/2017	Smith et al.	D811,963 S	3/2018	Sullivan
D793,299 S	8/2017	Krieg et al.	D811,964 S	3/2018	Perkins
D793,300 S	8/2017	Krieg et al.	D811,965 S	3/2018	Moffett et al.
D793,301 S	8/2017	Kozub	D812,525 S	3/2018	Lee
D793,302 S	8/2017	Kozub	D812,526 S	3/2018	Zipfel et al.
D793,311 S	8/2017	Whitla et al.	D812,527 S	3/2018	Perkins
D793,590 S	8/2017	Kozub et al.	D812,528 S	3/2018	Nakamura
D793,591 S	8/2017	Kozub et al.	D813,098 S	3/2018	Thompson et al.
D793,917 S	8/2017	Kozub	D813,109 S	3/2018	Zipfel et al.
D793,918 S	8/2017	Kozub	D813,110 S	3/2018	Whitla et al.
D794,229 S	8/2017	Barry	D813,111 S	3/2018	Sullivan
D794,230 S	8/2017	Kozub	D813,116 S	3/2018	Park
D795,747 S	8/2017	Bailie	D813,117 S	3/2018	Sullivan
D795,757 S	8/2017	Pevovar et al.	D813,121 S	3/2018	Swanseger
D795,758 S	8/2017	Karras	D813,730 S	3/2018	Zipfel et al.
D795,759 S	8/2017	Kozub et al.	D813,731 S	3/2018	McMahan
D795,760 S	8/2017	Kozub et al.	D813,732 S	3/2018	Whitla et al.
D795,762 S	8/2017	Lee	D813,733 S	3/2018	Lee
D795,763 S	8/2017	Kozub	D813,734 S	3/2018	Nakamura
D796,088 S	8/2017	McCabe et al.	D813,740 S	3/2018	Park
D796,093 S	8/2017	Mainville	D813,741 S	3/2018	Perkins
D796,390 S	9/2017	Pevovar et al.	D813,742 S	3/2018	McMahan et al.
D797,537 S	9/2017	Cooper et al.	D813,743 S	3/2018	Lee
D797,603 S	9/2017	Noone et al.	D813,744 S	3/2018	Whitla et al.
D797,614 S	9/2017	Lee	D813,748 S	3/2018	Kim
D797,616 S	9/2017	Lee	D813,753 S	3/2018	Loeb
D797,624 S	9/2017	Nakamura	D813,754 S	3/2018	Loeb
D797,625 S	9/2017	Perkins	D813,755 S	3/2018	Loeb
D797,631 S	9/2017	Pevovar et al.	D813,756 S	3/2018	Loeb
D797,632 S	9/2017	Zipfel et al.	D813,757 S	3/2018	Kozub
D797,967 S	9/2017	Barry	D813,758 S	3/2018	Gonzales
D797,970 S	9/2017	Mainville	D813,759 S	3/2018	Perkins
D797,971 S	9/2017	Mainville	D814,369 S	4/2018	Loeb
D797,972 S	9/2017	Whitla et al.	D814,982 S	4/2018	Whitla et al.
D798,204 S	9/2017	Mainville	D814,983 S	4/2018	Whitla et al.
D799,384 S	10/2017	Kozub et al.	D815,570 S	4/2018	McMahan et al.
D799,385 S	10/2017	Kozub et al.	D815,572 S	4/2018	Perkins
D799,386 S	10/2017	Kozub et al.	D815,573 S	4/2018	Whitla et al.
D799,728 S	10/2017	Whitla et al.	D815,574 S	4/2018	Mainville
D801,236 S	10/2017	Kozub et al.	D815,985 S	4/2018	Mueller
D801,577 S	10/2017	Ruiz	D815,993 S	4/2018	Kozub et al.
D801,882 S	11/2017	Kozub et al.	D815,994 S	4/2018	Nakamura
D802,205 S	11/2017	Ruiz	D816,003 S	4/2018	Perkins
D802,478 S	11/2017	Perkins	D816,558 S	5/2018	McMahan et al.
D802,491 S	11/2017	Mainville	D816,559 S	5/2018	McMahan et al.
D802,496 S	11/2017	Mainville	D816,561 S	5/2018	McMahan
D802,502 S	11/2017	McMahan	D816,562 S	5/2018	Whitla et al.
			D816,563 S	5/2018	McMahan et al.
			D816,564 S	5/2018	Kim
			D816,565 S	5/2018	Kim
			D816,566 S	5/2018	Loeb

(56)

References Cited

U.S. PATENT DOCUMENTS

D817,836 S	5/2018	McMahan et al.	D840,565 S	2/2019	Whitla et al.
D818,156 S	5/2018	Kim et al.	D840,570 S	2/2019	Kim et al.
D818,157 S	5/2018	Zipfel et al.	D840,571 S	2/2019	Zipfel et al.
D818,158 S	5/2018	Zipfel et al.	D840,572 S	2/2019	Perkins
D818,159 S	5/2018	Zipfel et al.	D840,885 S	2/2019	Park Cheng
D818,160 S	5/2018	Perkins	D841,527 S	2/2019	Kozub et al.
D818,406 S	5/2018	McMahan et al.	D841,532 S	2/2019	Koo et al.
D818,876 S	5/2018	Whitla et al.	D841,540 S	2/2019	Koo et al.
D818,877 S	5/2018	Nakamura et al.	D841,541 S	2/2019	Krieg
D818,878 S	5/2018	McMahan et al.	D841,542 S	2/2019	Koo et al.
D818,892 S	5/2018	Lee	D841,547 S	2/2019	Zipfel et al.
D818,893 S	5/2018	Kim	D841,843 S	2/2019	Park
D818,903 S	5/2018	Zipfel et al.	D841,844 S	2/2019	Perkins
D818,906 S	5/2018	McMahan	D841,845 S	2/2019	Park
D818,907 S	5/2018	Whitla et al.	D842,306 S	2/2019	Lindo et al.
D818,915 S	5/2018	Kozub et al.	D842,178 S	3/2019	Pinazzo et al.
D818,922 S	5/2018	Whitla et al.	D843,023 S	3/2019	Whitla et al.
D819,505 S	6/2018	McMahan et al.	D843,024 S	3/2019	Hochmuth
D819,519 S	6/2018	Whitla et al.	D843,025 S	3/2019	Smith et al.
D821,617 S	6/2018	Perkins	D843,275 S	3/2019	Koo et al.
D822,550 S	7/2018	Wassell et al.	D843,280 S	3/2019	Thurber et al.
D822,551 S	7/2018	McMahan et al.	D843,616 S	3/2019	Smith et al.
D823,188 S	7/2018	Loeb	D843,617 S	3/2019	Smith et al.
D823,738 S	7/2018	Kim	D843,891 S	3/2019	Thompson et al.
D823,741 S	7/2018	Kim	D843,904 S	3/2019	Kim
D823,762 S	7/2018	Loeb	D844,184 S	3/2019	Whitla et al.
D823,763 S	7/2018	Koo et al.	D844,185 S	3/2019	Hochmuth
D824,811 S	8/2018	Mainville	D844,186 S	3/2019	Smith et al.
D824,812 S	8/2018	Loeb	D845,184 S	4/2019	Zipfel
D824,824 S	8/2018	Kim	D845,186 S	4/2019	Koo et al.
D824,825 S	8/2018	Loeb	D845,187 S	4/2019	Pinazzo et al.
D825,083 S	8/2018	Perkins	D845,188 S	4/2019	Pinazzo et al.
D825,388 S	8/2018	Karras et al.	D845,189 S	4/2019	Pinazzo et al.
D825,403 S	8/2018	Whitla et al.	D845,190 S	4/2019	Zipfel
D826,114 S	8/2018	Smith et al.	D845,196 S	4/2019	Kozub
D826,435 S	8/2018	Kim	D845,518 S	4/2019	Kozub
D826,803 S	8/2018	Smith et al.	D845,519 S	4/2019	Zipfel
D827,506 S	9/2018	McMahan et al.	D846,448 S	4/2019	Loeb
D827,508 S	9/2018	Whitla et al.	D846,457 S	4/2019	Koo et al.
D827,510 S	9/2018	Kim	D846,458 S	4/2019	Mack et al.
D827,527 S	9/2018	Loeb	D846,769 S	4/2019	Koo et al.
D828,246 S	9/2018	Loeb	D846,770 S	4/2019	Kozub
D828,261 S	9/2018	Moffett et al.	D846,771 S	4/2019	Zipfel
D828,935 S	9/2018	Hochmuth	D846,772 S	4/2019	Pinazzo et al.
D829,622 S	10/2018	Jacob	D847,027 S	4/2019	Loeb
D830,241 S	10/2018	Kozub	D847,028 S	4/2019	Loeb
D830,242 S	10/2018	Zipfel	D847,038 S	4/2019	Loeb
D830,252 S	10/2018	Swanseger	D847,041 S	4/2019	Blanski et al.
D830,258 S	10/2018	McMahan et al.	D847,042 S	4/2019	Pinazzo et al.
D830,261 S	10/2018	Jacob	D847,043 S	4/2019	Kozub
D830,589 S	10/2018	Henriques	D847,044 S	4/2019	Zipfel
D832,752 S	11/2018	Lee	D847,045 S	4/2019	Whitla et al.
D835,003 S	12/2018	Thompson et al.	D847,046 S	4/2019	Whitla et al.
D835,012 S	12/2018	Smith et al.	D847,047 S	4/2019	Krieg et al.
D836,502 S	* 12/2018	Koo D12/163	D847,390 S	4/2019	Koo et al.
D836,503 S	* 12/2018	Koo D12/163	D847,391 S	4/2019	Pinazzo et al.
D837,105 S	1/2019	Loeb	D847,392 S	4/2019	Zipfel
D837,109 S	1/2019	Kozub et al.	D847,699 S	5/2019	Kozub
D837,424 S	1/2019	Whitla et al.	D847,700 S	5/2019	Kozub
D838,015 S	1/2019	McMahan et al.	D847,701 S	5/2019	Kozub
D838,016 S	1/2019	McMahan et al.	D847,702 S	5/2019	Zipfel
D838,390 S	1/2019	McMahan et al.	D847,703 S	5/2019	Kozub
D838,391 S	1/2019	McMahan et al.	D847,704 S	5/2019	Zipfel
D839,157 S	1/2019	Smith et al.	D847,705 S	5/2019	Zipfel
D839,163 S	1/2019	Pinazzo et al.	D847,707 S	5/2019	Park Cheng et al.
D839,164 S	1/2019	Zipfel	D847,714 S	5/2019	Mack et al.
D839,460 S	1/2019	Zipfel et al.	D848,315 S	5/2019	Koo et al.
D840,068 S	2/2019	Zipfel et al.	D848,318 S	5/2019	McMahan et al.
D840,069 S	2/2019	Perkins	D848,320 S	5/2019	Pinazzo et al.
D840,285 S	2/2019	Mack et al.	D848,322 S	5/2019	Mack et al.
D840,286 S	2/2019	Mack et al.	D848,323 S	5/2019	Mack et al.
D840,293 S	2/2019	Koo et al.	D848,324 S	5/2019	Thurber et al.
D840,302 S	2/2019	O'Donnell et al.	D848,325 S	5/2019	Thurber et al.
D840,303 S	2/2019	Park Cheng	D848,647 S	5/2019	Kozub
D840,306 S	2/2019	Kozub	D848,908 S	5/2019	Krieg
			D848,909 S	5/2019	Lee
			D848,911 S	5/2019	De Leon
			D848,915 S	5/2019	Izard
			D849,627 S	5/2019	Zipfel

(56)

References Cited

U.S. PATENT DOCUMENTS

D849,629 S	5/2019	De Leon	
D849,630 S	5/2019	De Leon	
D850,341 S	6/2019	Riggs et al.	
D850,989 S	6/2019	Kozub	
D851,002 S	6/2019	Kozub	
D851,541 S	6/2019	Pinazzo	
D851,542 S	6/2019	Mack	
D851,547 S	6/2019	Mack et al.	
D851,548 S	6/2019	Mack et al.	
D851,549 S	6/2019	Mack et al.	
D851,550 S	6/2019	Mack et al.	
D851,551 S	6/2019	Mack et al.	
D851,552 S	6/2019	Mack et al.	
D851,555 S	6/2019	Whitla et al.	
D851,556 S	6/2019	Thurber et al.	
D851,557 S	6/2019	Thurber et al.	
D851,558 S	6/2019	Thurber et al.	
D851,559 S	6/2019	Thurber et al.	
D851,560 S	6/2019	Yong et al.	
D851,561 S	6/2019	Yong et al.	
D857,568 S *	8/2019	Lee	D12/163
D864,026 S *	10/2019	Lim	D12/91

* cited by examiner

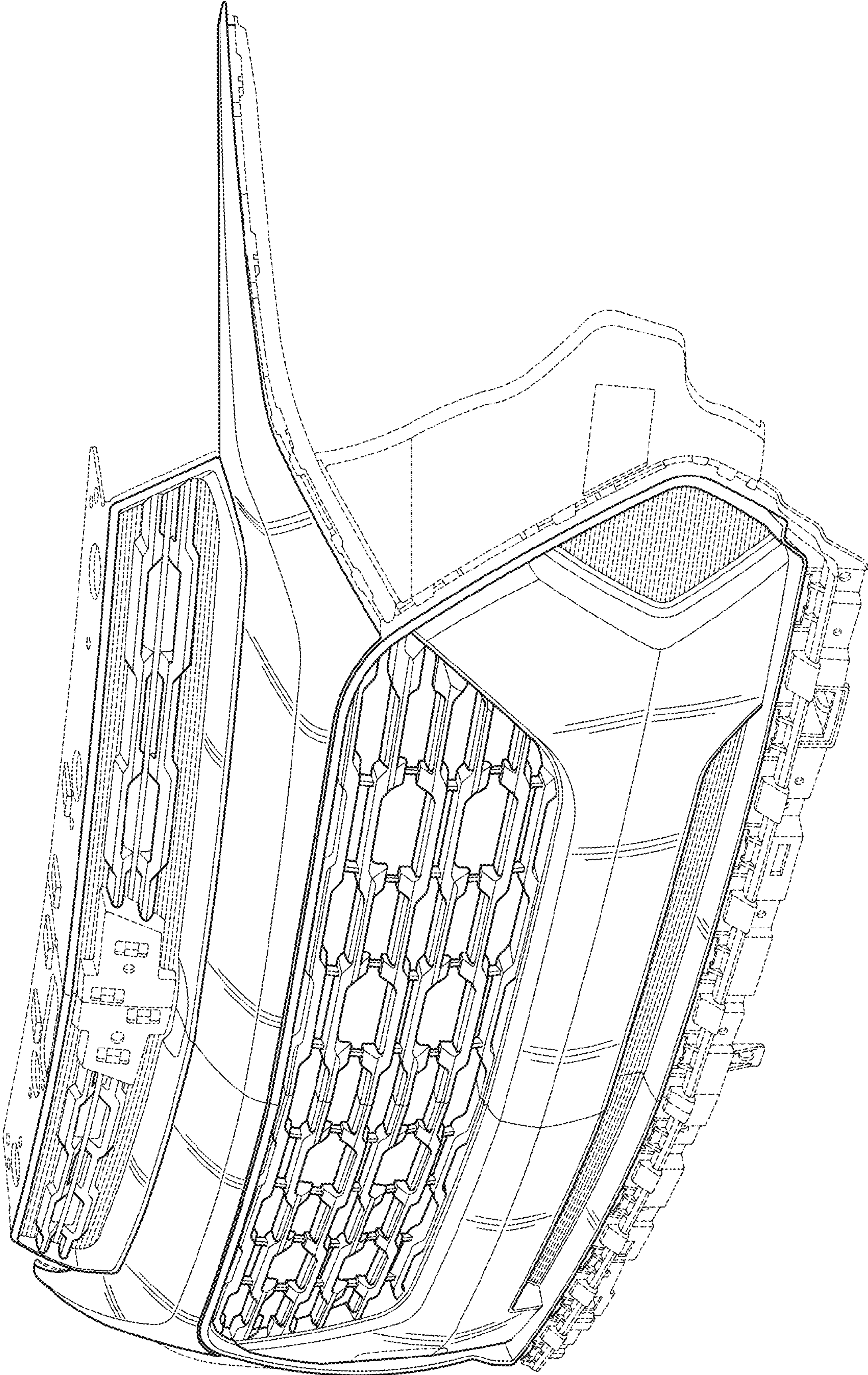

FIG. 1

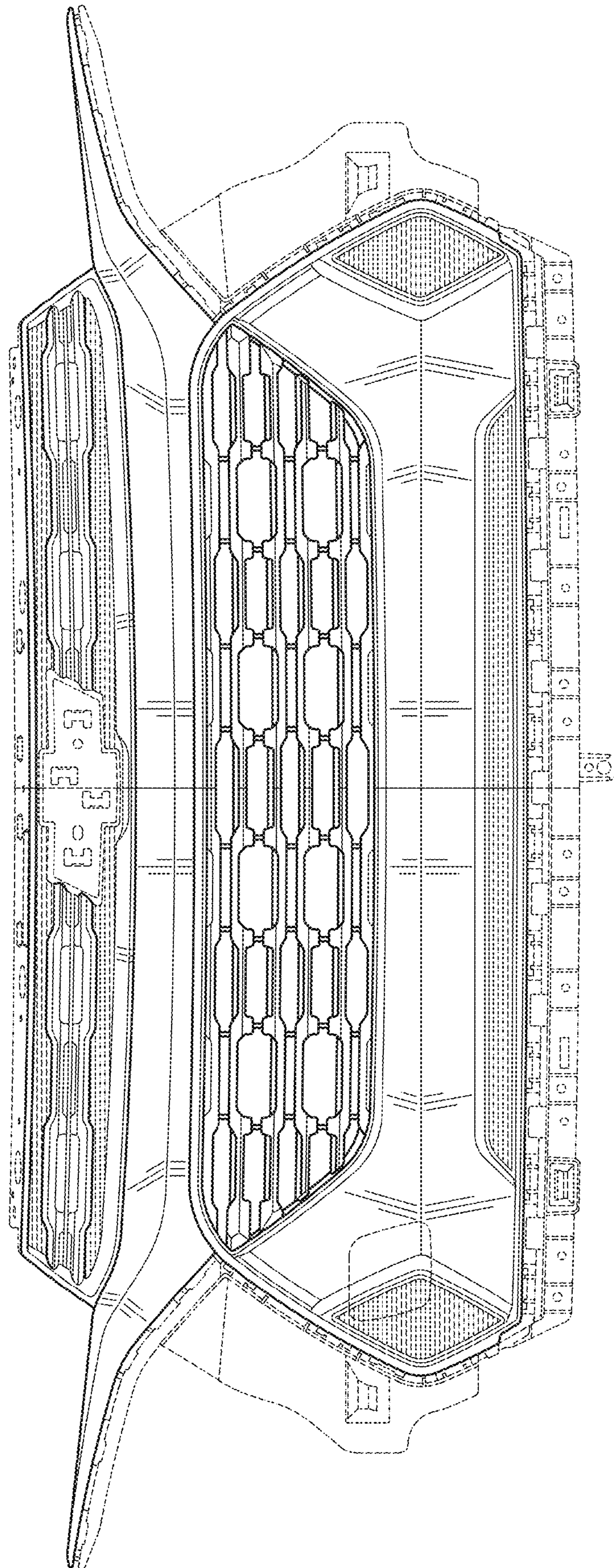

FIG. 2

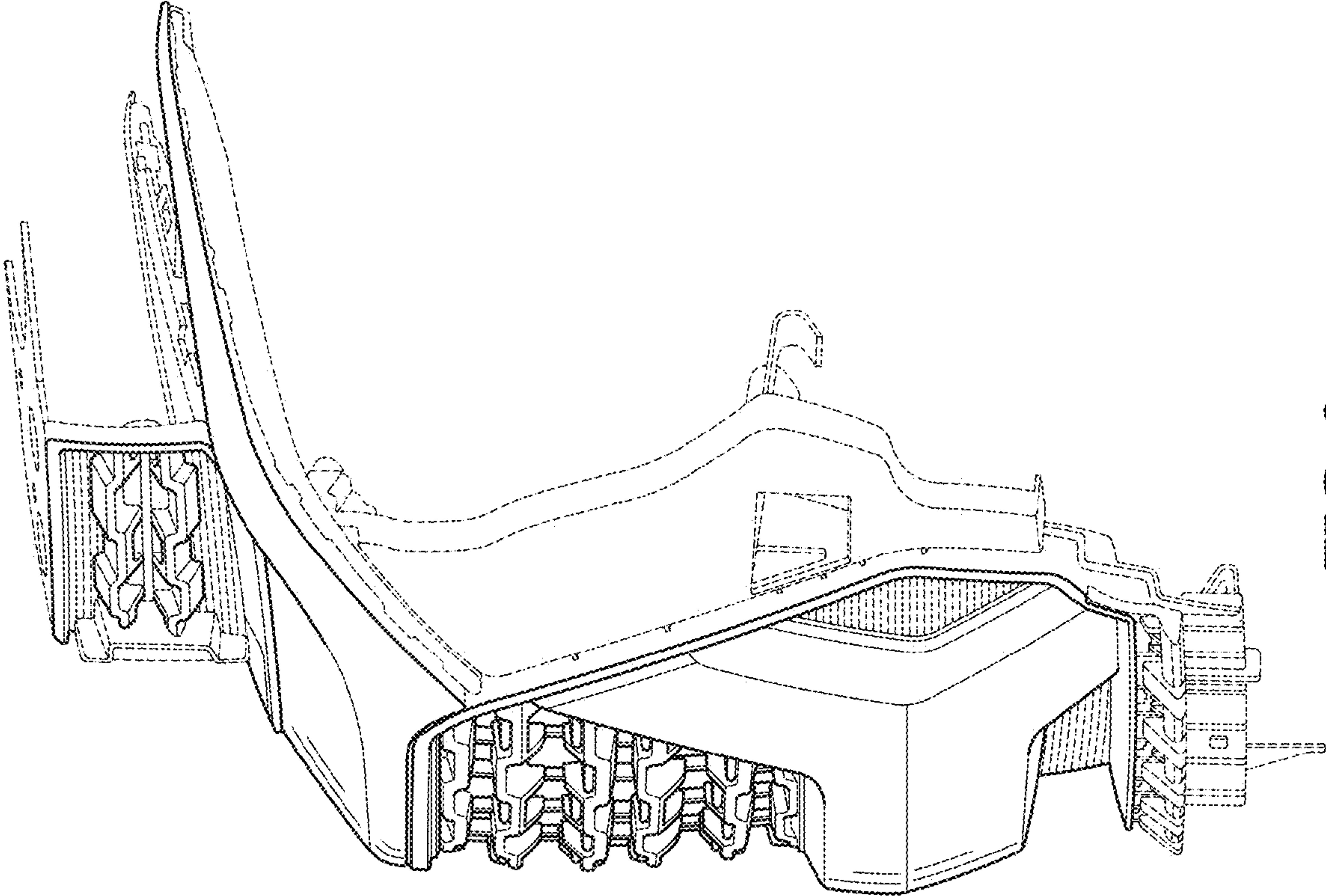

FIG. 3

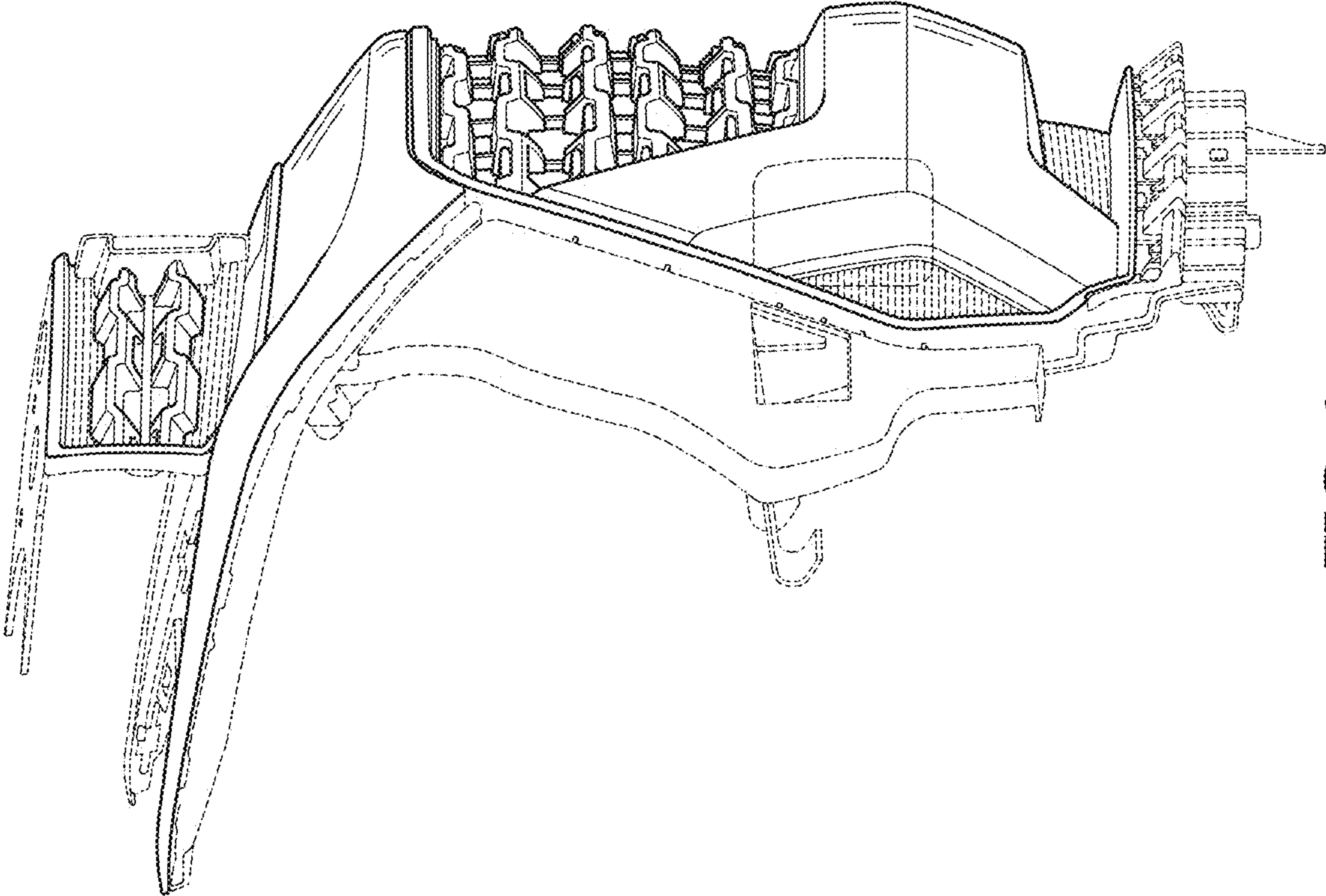

FIG. 4

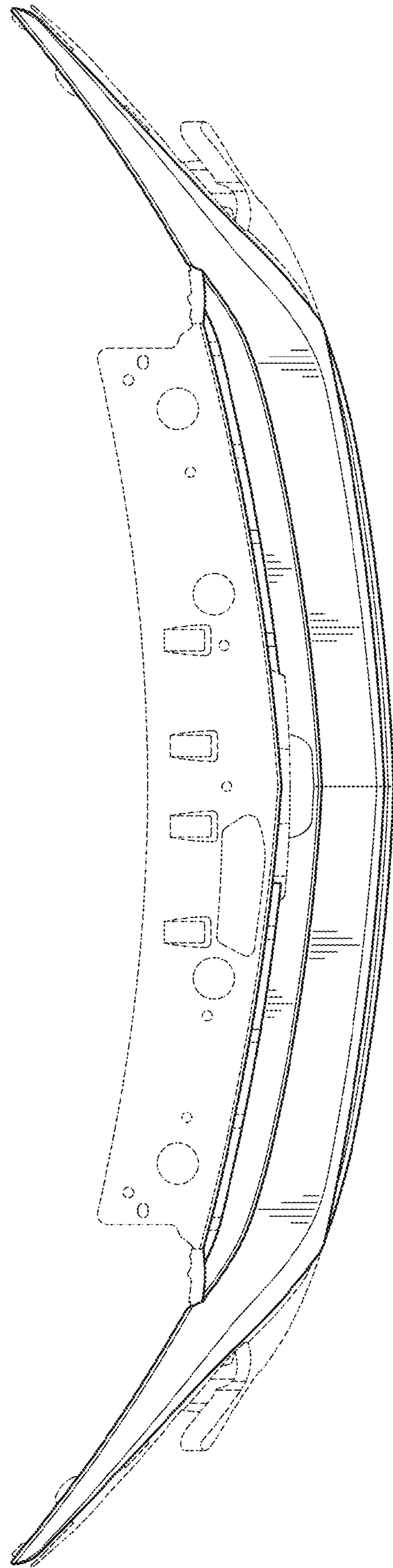

FIG. 5

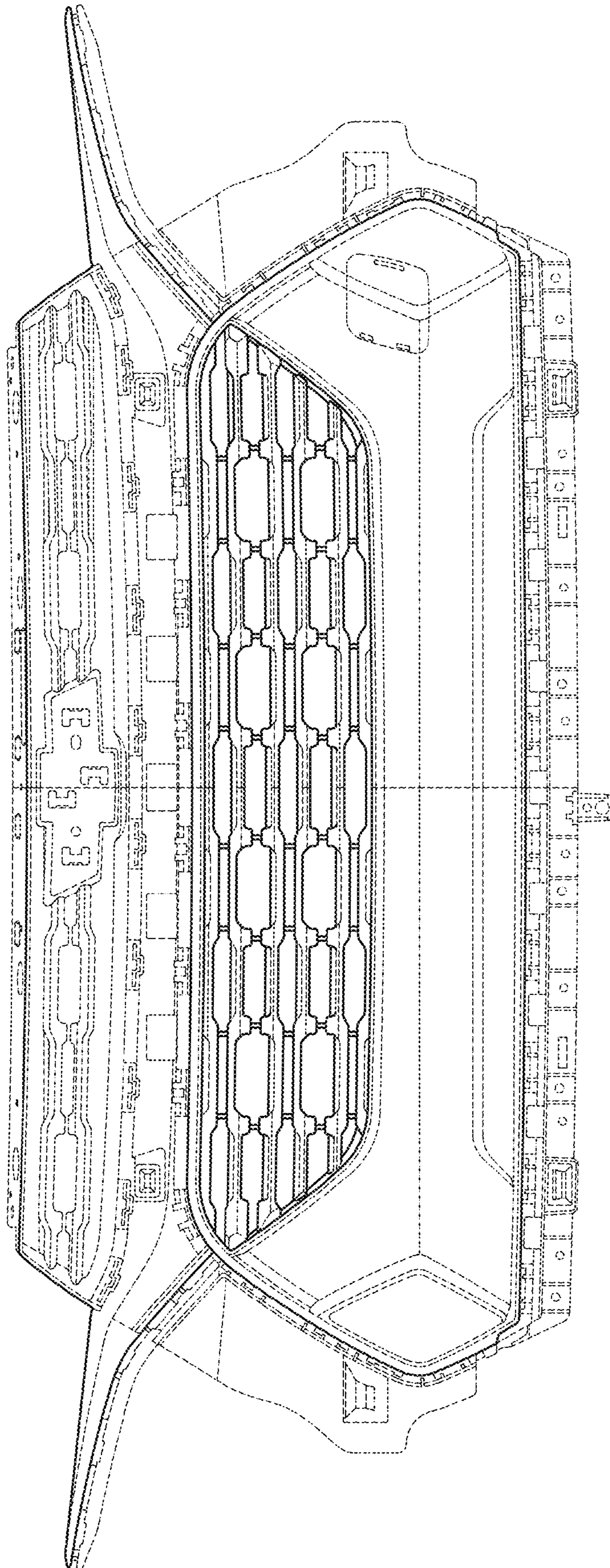

FIG. 6

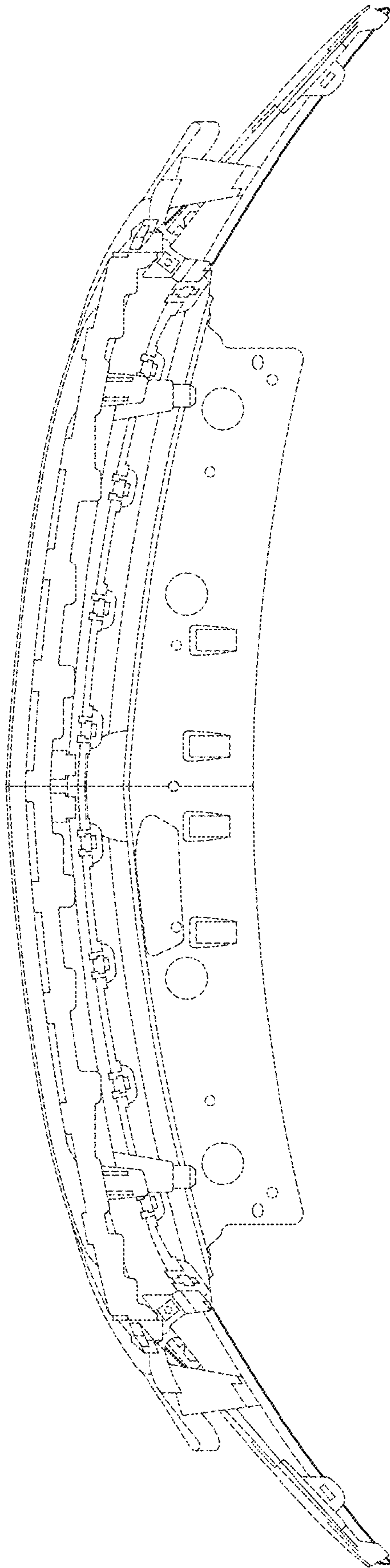

FIG. 7