



US00D920123S

(12) **United States Design Patent**
McGahan et al.

(10) **Patent No.:** **US D920,123 S**

(45) **Date of Patent:** **** May 25, 2021**

(54) **BOTTLE**

(71) Applicant: **The Procter & Gamble Company,**
Cincinnati, OH (US)

(72) Inventors: **Douglas Michael McGahan,** Bethel,
OH (US); **Marc Christopher Hatcher,**
Milford, OH (US)

(73) Assignee: **The Procter & Gamble Company,**
Cincinnati, OH (US)

(**) Term: **15 Years**

(21) Appl. No.: **29/732,317**

(22) Filed: **Apr. 23, 2020**

(51) **LOC (13) Cl.** **09-01**

(52) **U.S. Cl.**

USPC **D9/542; D9/563; D9/571**

(58) **Field of Classification Search**

USPC D9/434, 516, 530, 542, 549, 550, 558,
D9/563, 571, 574, 715, 719

CPC B65D 1/00; B65D 1/02; B65D 1/0223;
B65D 23/00; B65D 51/32; B65D
2501/00; B65D 2501/0009; B65D
2501/0081

See application file for complete search history.

(56) **References Cited**

U.S. PATENT DOCUMENTS

D67,808 S *	7/1925	Kammer	D9/574
D201,997 S	8/1965	Ludetke		
D202,219 S *	9/1965	Vanderhyder etal.	D9/574
D204,707 S	5/1966	Abbott		
D205,731 S *	9/1966	Levy	D9/542
D207,461 S *	4/1967	Argenta	D9/542
D211,005 S	5/1968	Vanderhyde		
D212,278 S *	9/1968	Weckman	D9/550
D212,456 S *	10/1968	Vanderhyder	D9/531

(Continued)

OTHER PUBLICATIONS

All Office Actions; U.S. Appl. No. 29/732,315.

Primary Examiner — Dana Meyrow

(74) *Attorney, Agent, or Firm* — Andrés Velarde

(57) **CLAIM**

The ornamental design for a bottle, as shown and described.

DESCRIPTION

FIG. 1 is a perspective view of an embodiment of a bottle embodying our new design;

FIG. 2 is a front view thereof;

FIG. 3 is a left view thereof;

FIG. 4 is a back view thereof;

FIG. 5 is a right view thereof;

FIG. 6 is a top view thereof;

FIG. 7 is a bottom view thereof;

FIG. 8 is a perspective view of an embodiment of a bottle embodying our new design;

FIG. 9 is a front view thereof;

FIG. 10 is a left view thereof;

FIG. 11 is a back view thereof;

FIG. 12 is a right view thereof;

FIG. 13 is a top view thereof;

FIG. 14 is a bottom view thereof;

FIG. 15 is a perspective view of an embodiment of a bottle embodying our new design;

FIG. 16 is a front view thereof;

FIG. 17 is a left view thereof;

FIG. 18 is a back view thereof;

FIG. 19 is a right view thereof;

FIG. 20 is a top view thereof; and,

FIG. 21 is a bottom view thereof.

The broken lines in the drawings illustrate the portions of the bottle that form no part of the claimed design. Certain features currently not in broken lines may be placed into broken lines in other embodiments while other features in broken lines may be placed in solid lines in other embodiments.

1 Claim, 12 Drawing Sheets

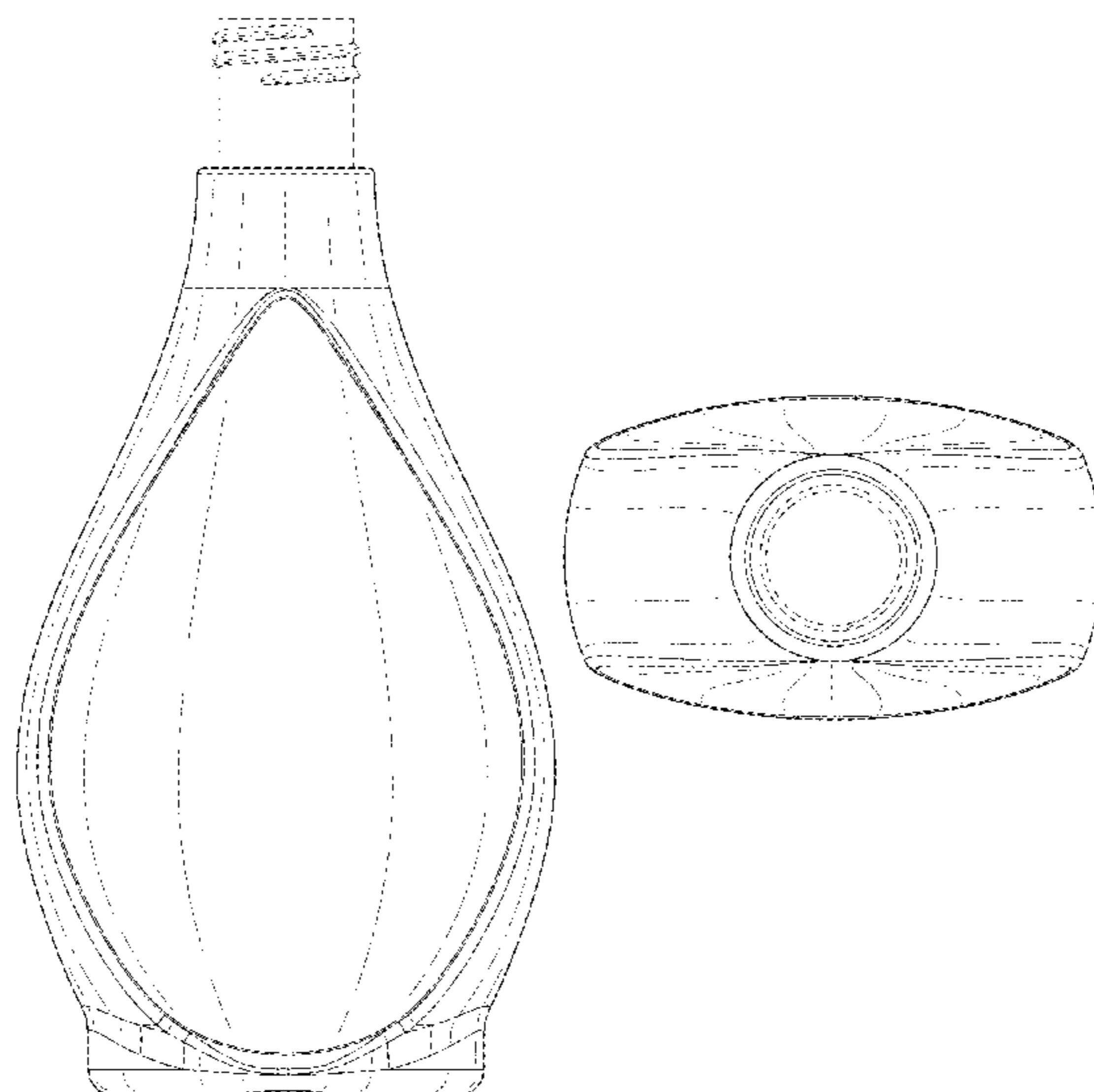

(56)

References Cited

U.S. PATENT DOCUMENTS

D217,591 S *	5/1970	Biscoe etal.	D9/574	D558,590 S *	1/2008	Cowan-Hughes	D9/682
D222,530 S *	11/1971	Luedtke	D9/529	D565,422 S *	4/2008	Cowan-Hughes	D9/563
D223,436 S	4/1972	Hills			D635,462 S	4/2011	Kuzma		
D225,834 S *	1/1973	Kneapler	D9/571	D654,800 S *	2/2012	Geeraert	D9/565
D236,801 S *	9/1975	Waring	D9/563	D657,258 S *	4/2012	Geeraert	D9/565
D237,254 S *	10/1975	Kretz	D9/531	D687,714 S	8/2013	De		
D237,358 S *	10/1975	Blank	D9/542	D758,874 S	6/2016	Nguyen		
D237,946 S *	12/1975	Pardo	D9/529	D759,490 S	6/2016	Cetnar		
D238,555 S *	1/1976	Blank	D9/550	D759,495 S *	6/2016	Hawry	D9/565
D246,953 S *	1/1978	Britt	D9/542	D791,607 S *	7/2017	Hawry	D9/575
D257,504 S *	11/1980	Weckman	D9/563	D794,469 S *	8/2017	Yen	D9/563
D260,238 S *	8/1981	Costa	D9/542	D820,095 S	6/2018	Palm		
D270,711 S	9/1983	Weckman			D821,112 S *	6/2018	Cannamela	D6/542
D353,775 S *	12/1994	Thompson	D9/545	D821,212 S *	6/2018	Cannamela	D9/542
D447,696 S	9/2001	Weber			D821,882 S *	7/2018	Cannamela	D9/529
D447,955 S	9/2001	Beaver			D821,883 S *	7/2018	Cannamela	D9/542
D469,022 S *	1/2003	Kuzma	D9/550	D822,493 S *	7/2018	Cannamela	D9/529
D491,067 S	6/2004	Crawford			D834,940 S *	12/2018	Mazzei	D9/529
D529,392 S *	10/2006	Little	D9/563	D839,099 S *	1/2019	Rhodes	D9/529
					D871,912 S *	1/2020	McGann	D9/543
					D910,452 S *	2/2021	Hatcher	D9/542

* cited by examiner



FIG. 1

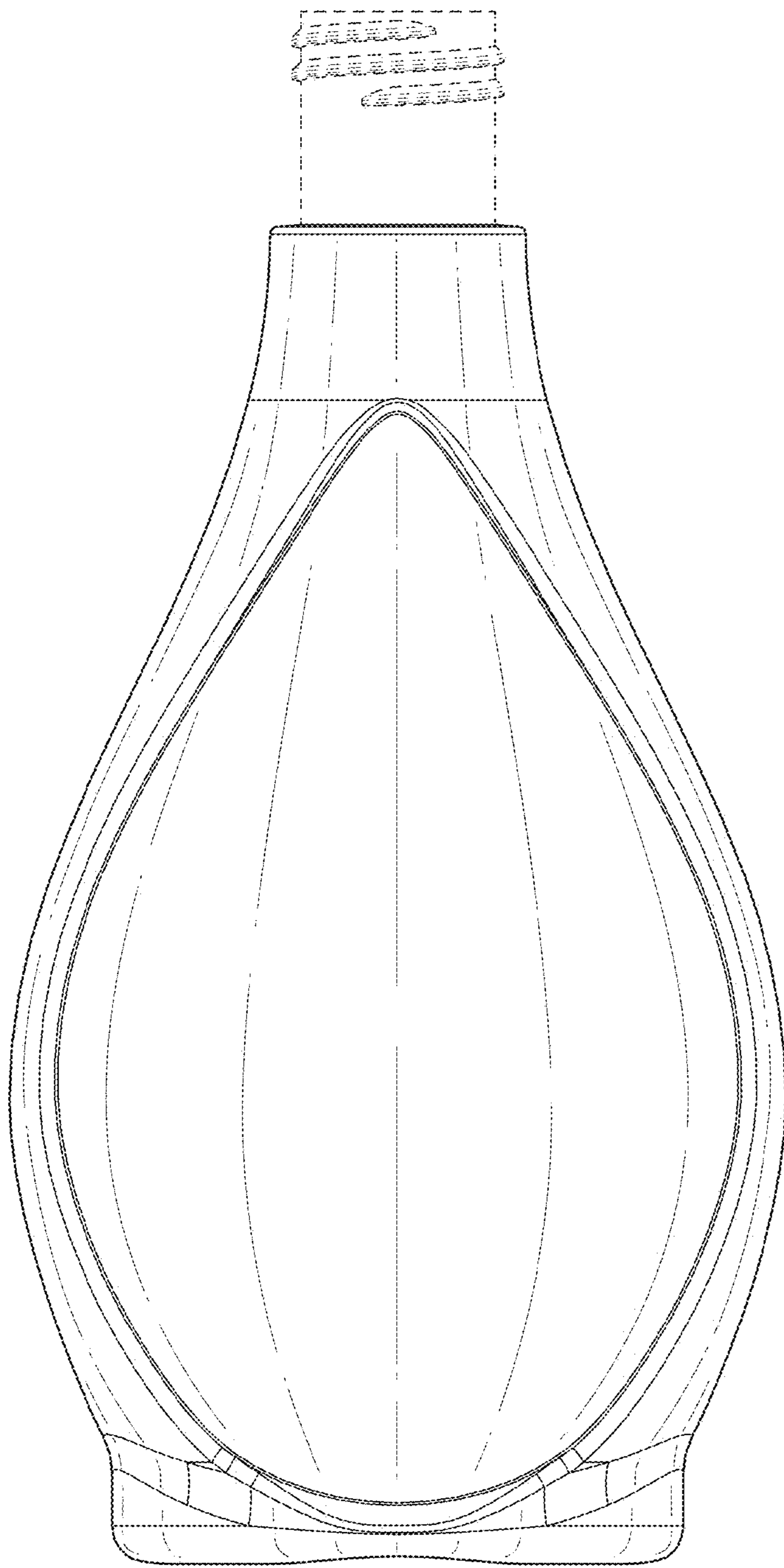

FIG. 2

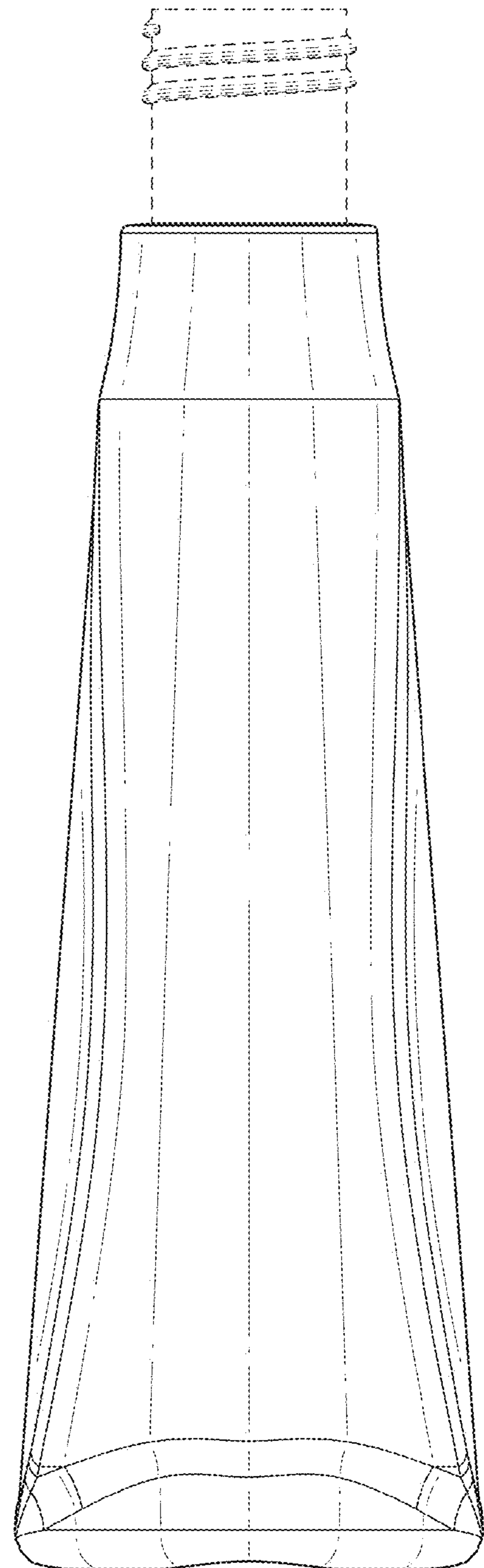

FIG. 3

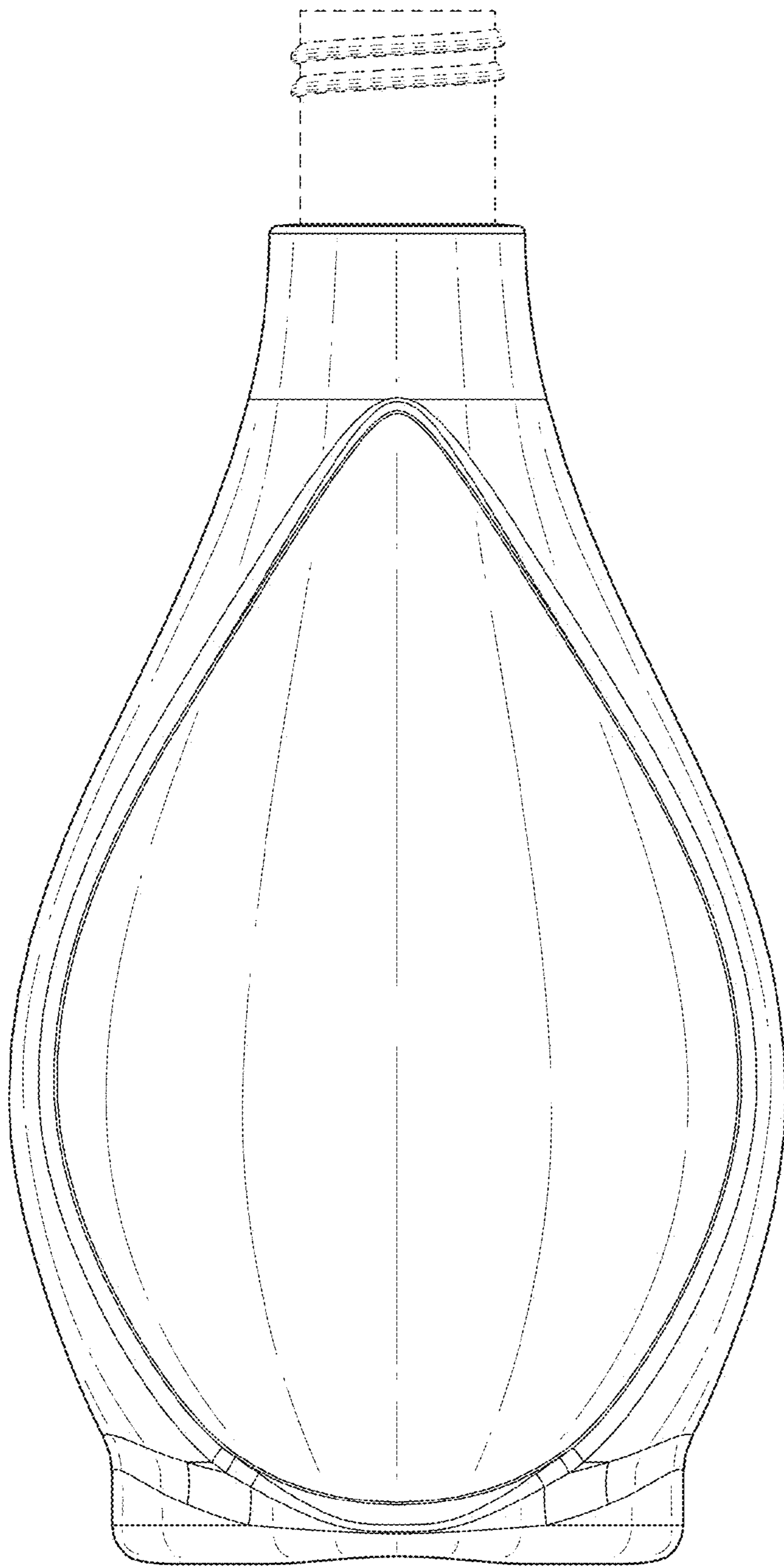

FIG. 4

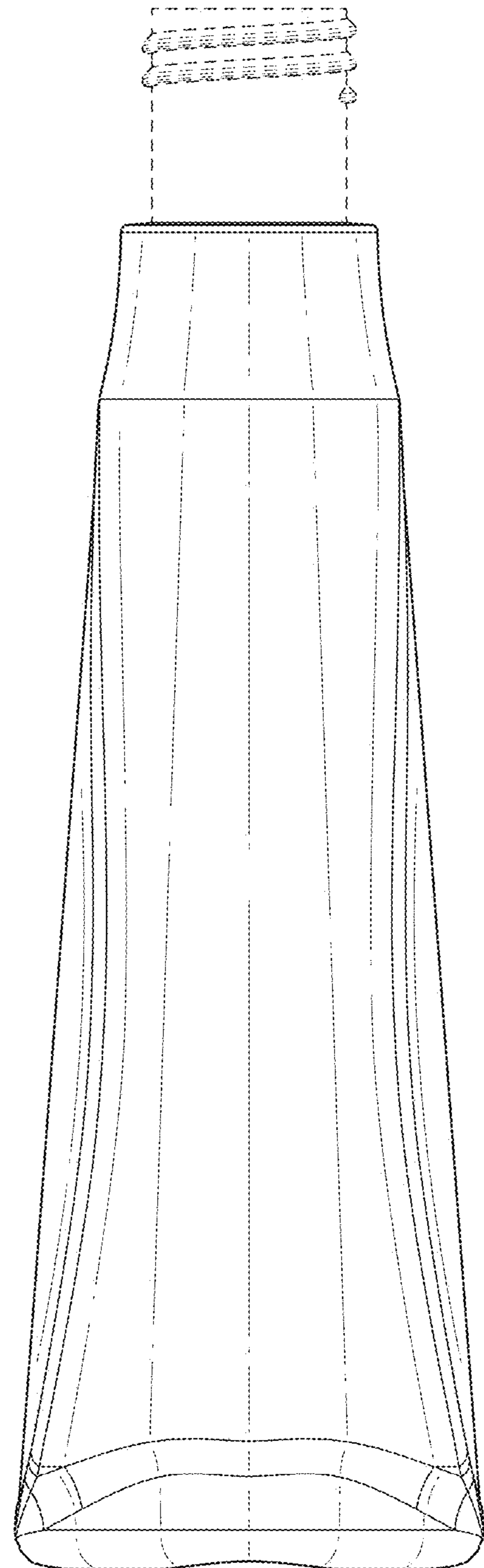

FIG. 5

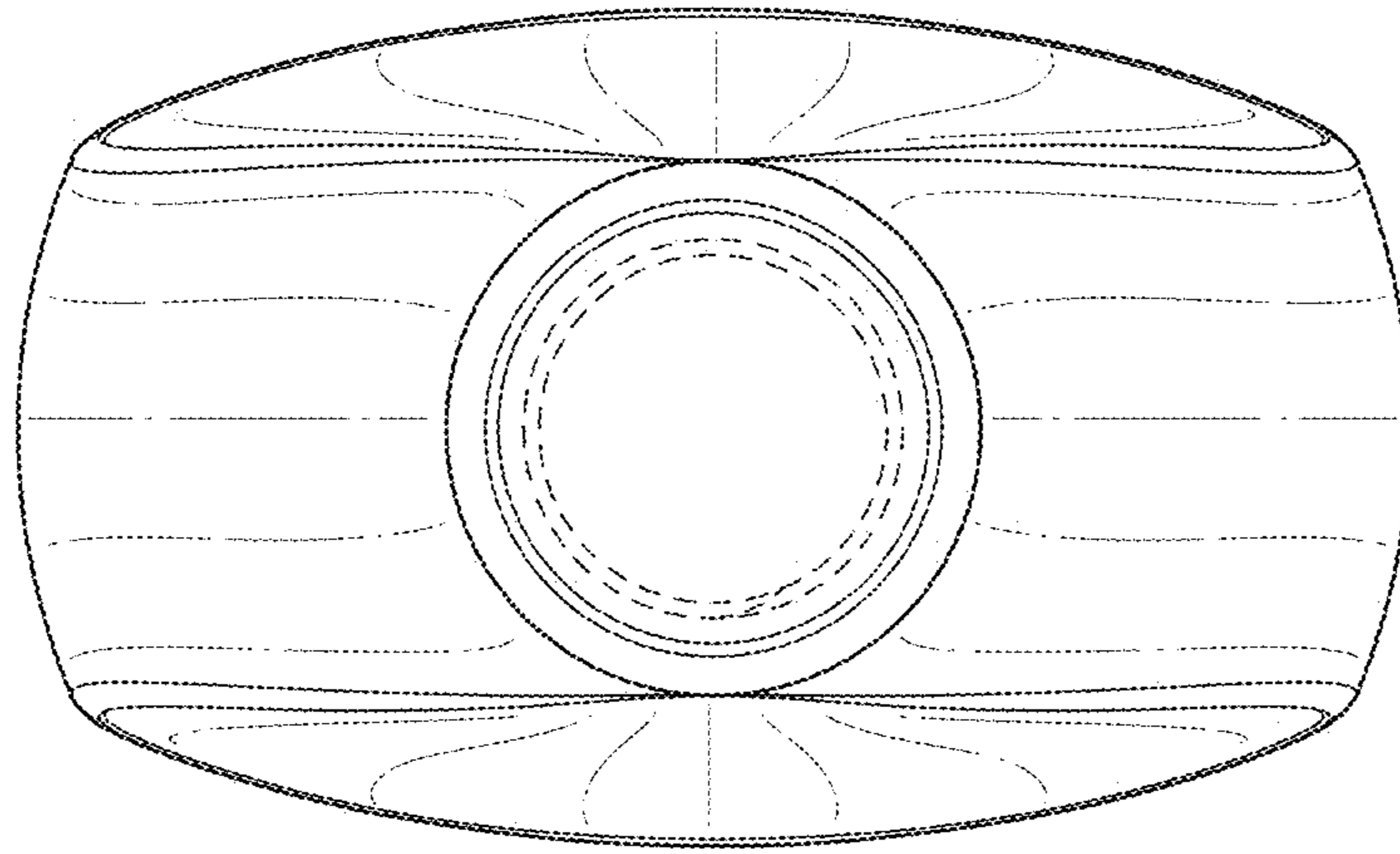

FIG. 6

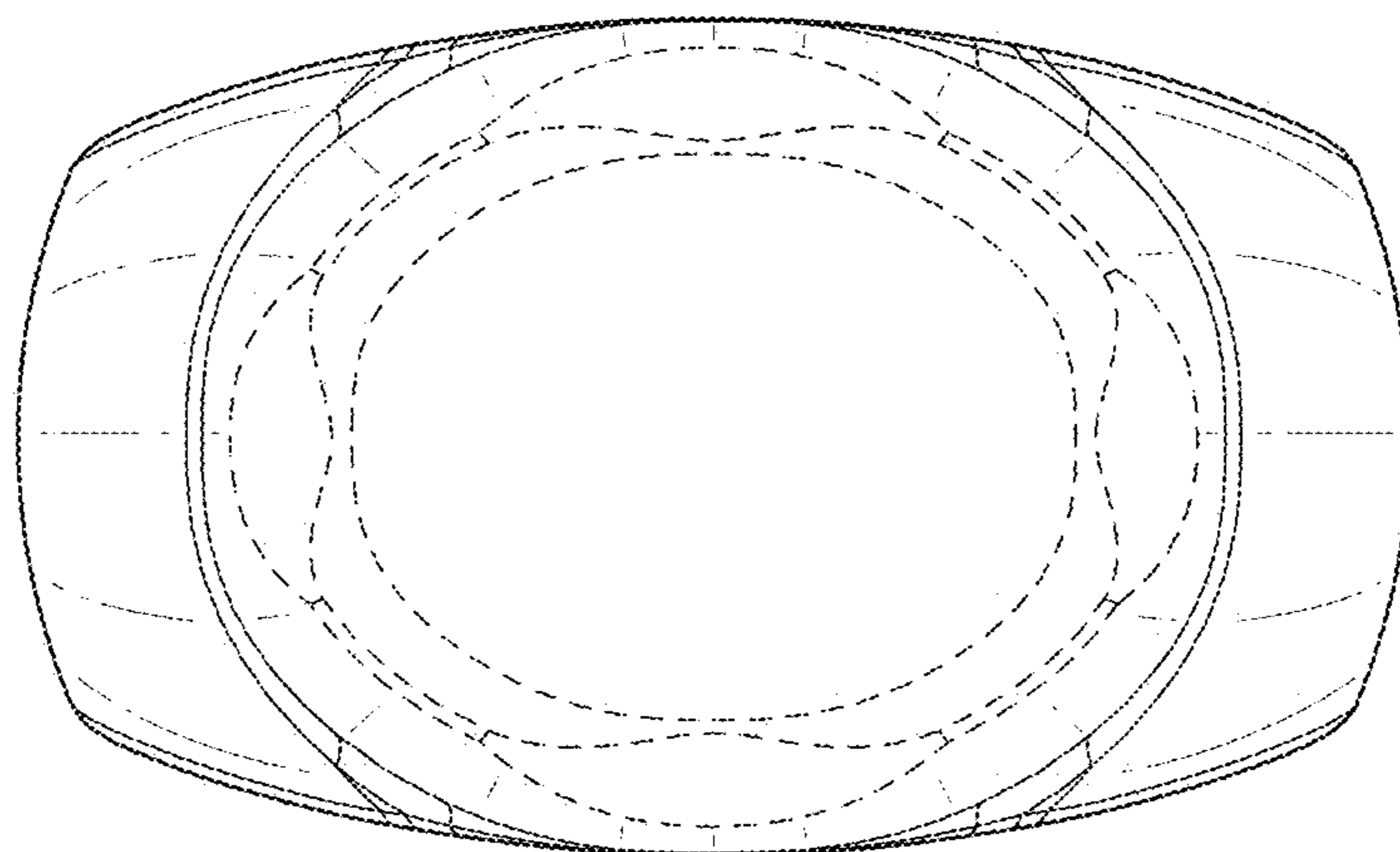

FIG. 7

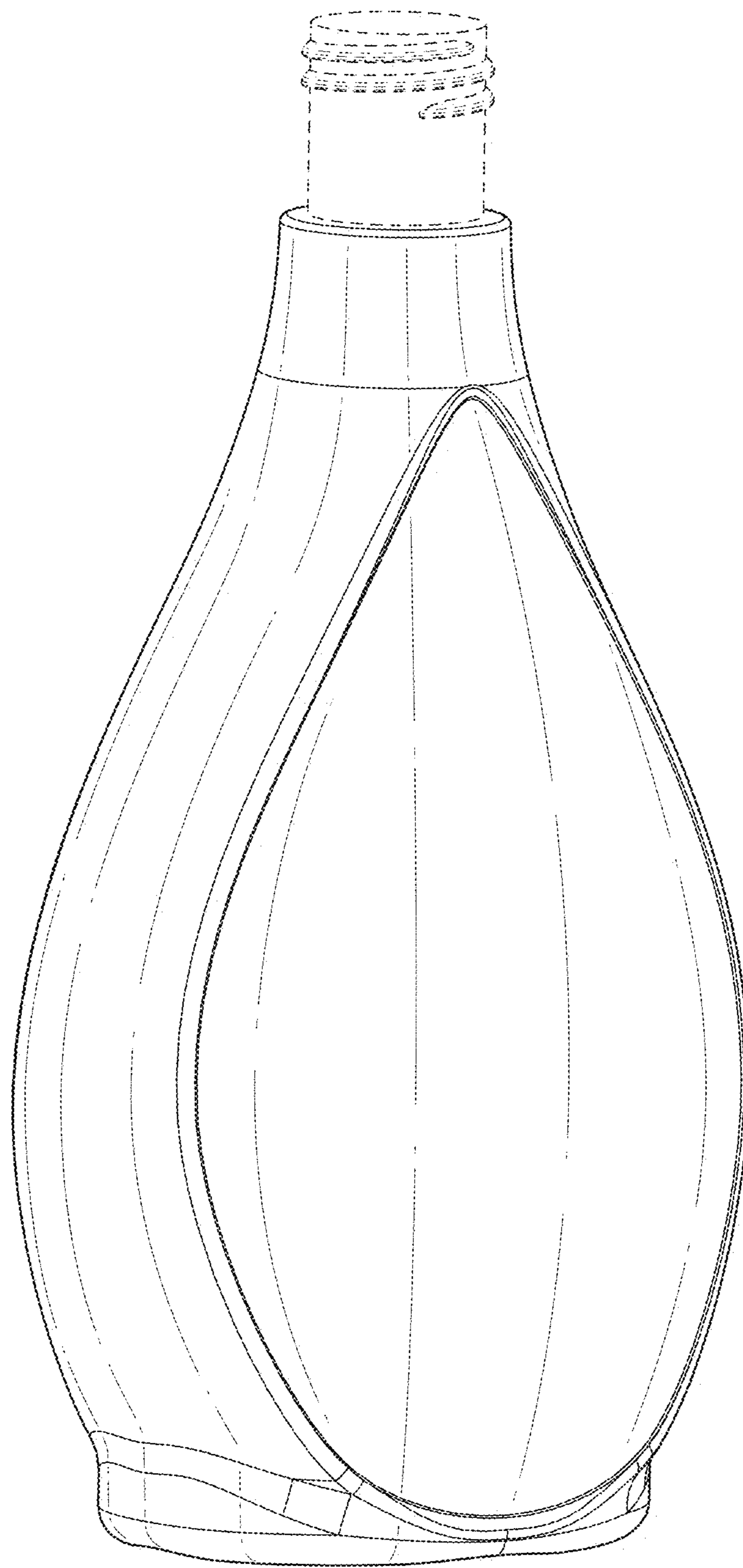

FIG. 8

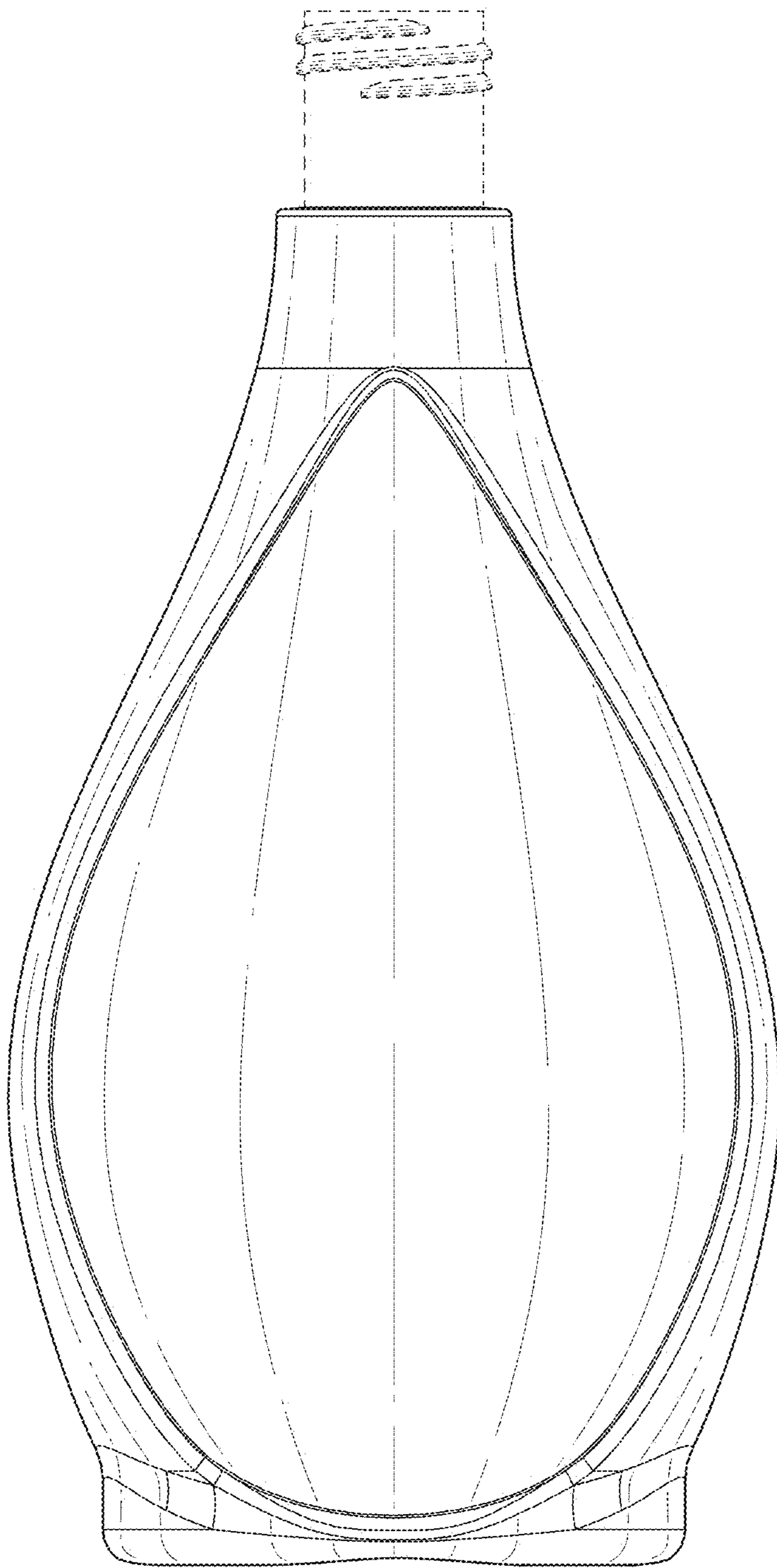

FIG. 9

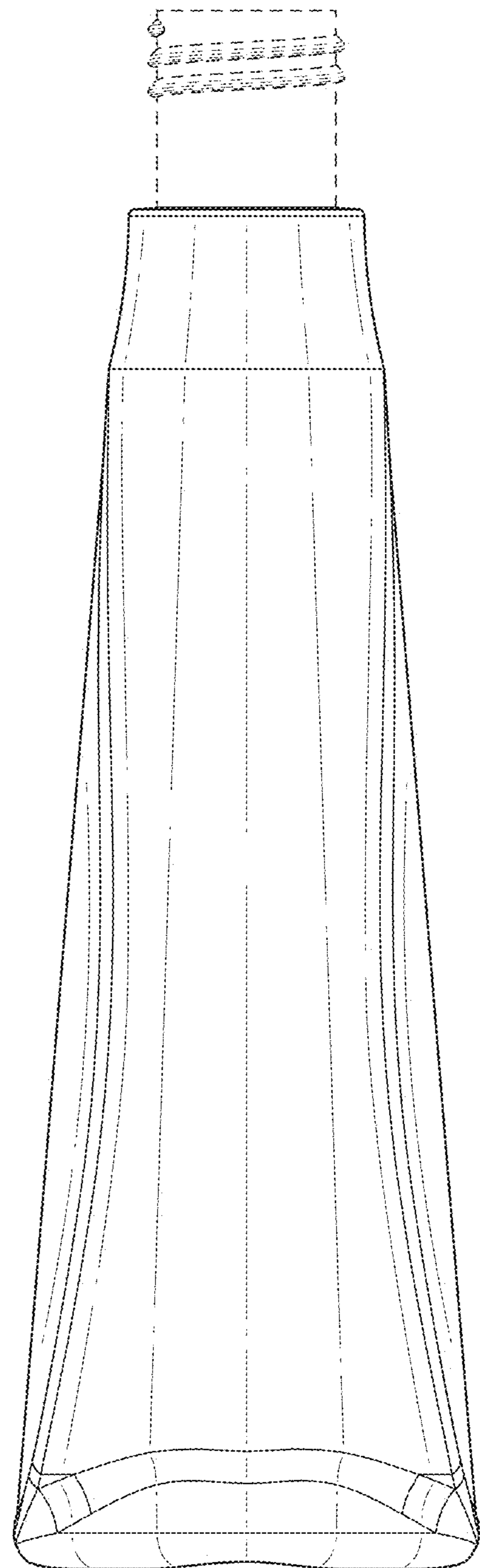

FIG. 10

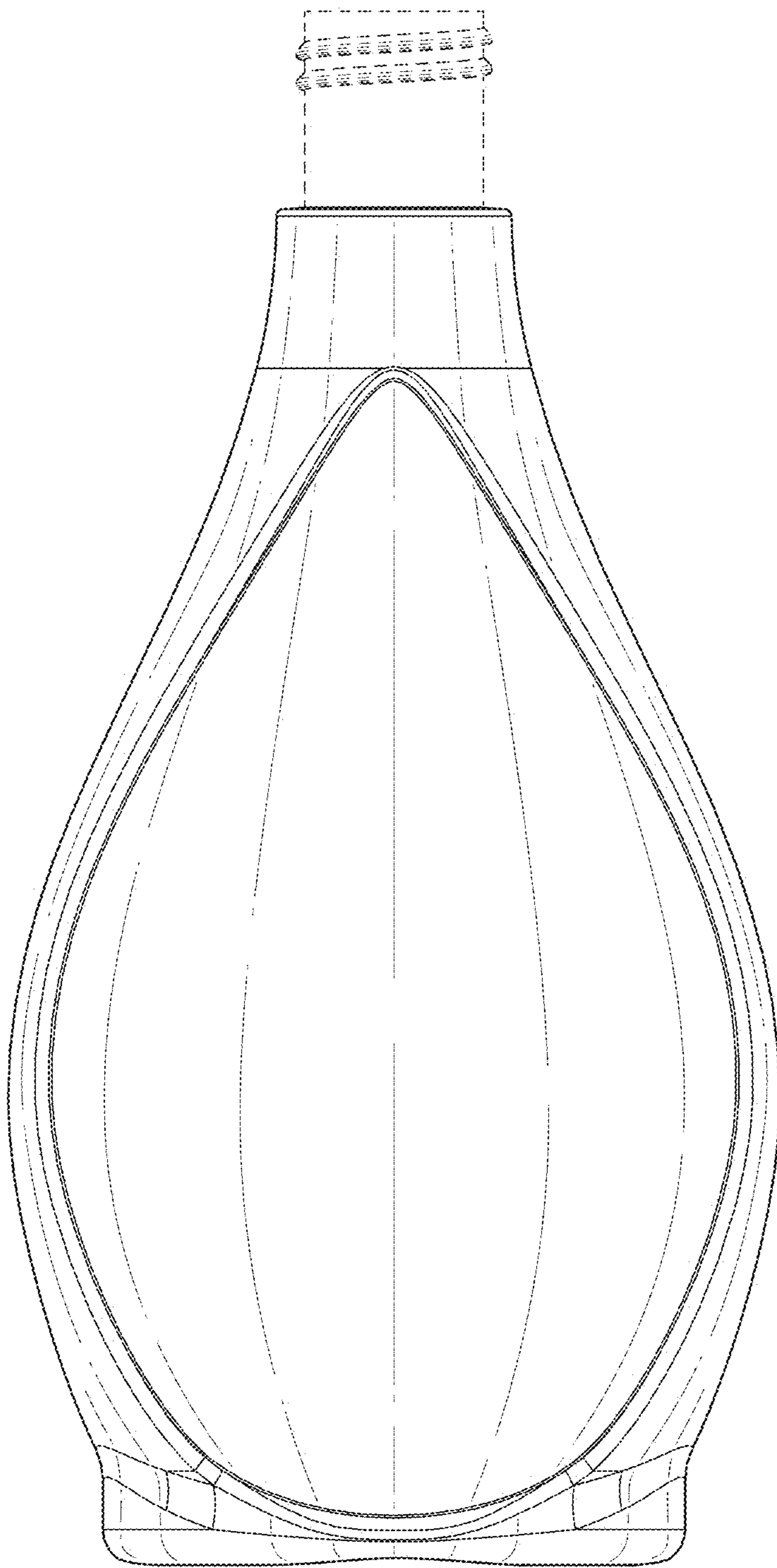

FIG. 11

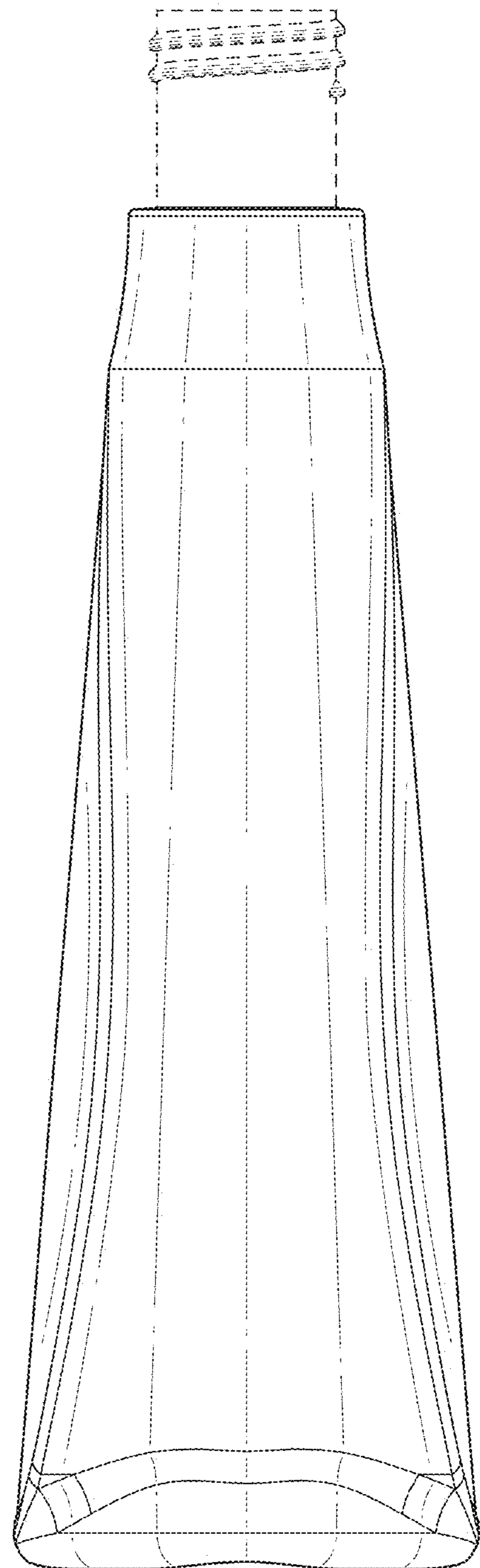

FIG. 12

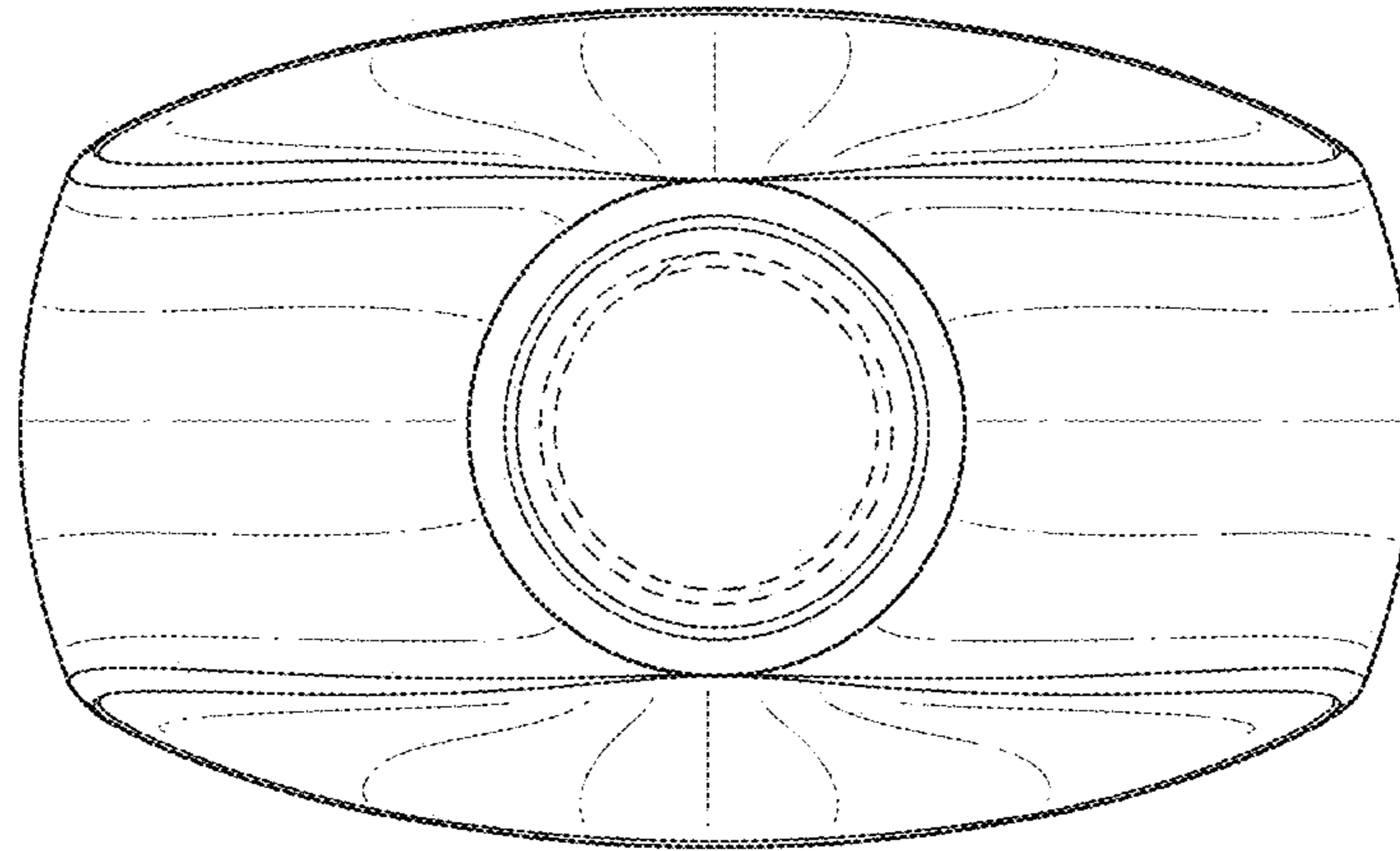

FIG. 13

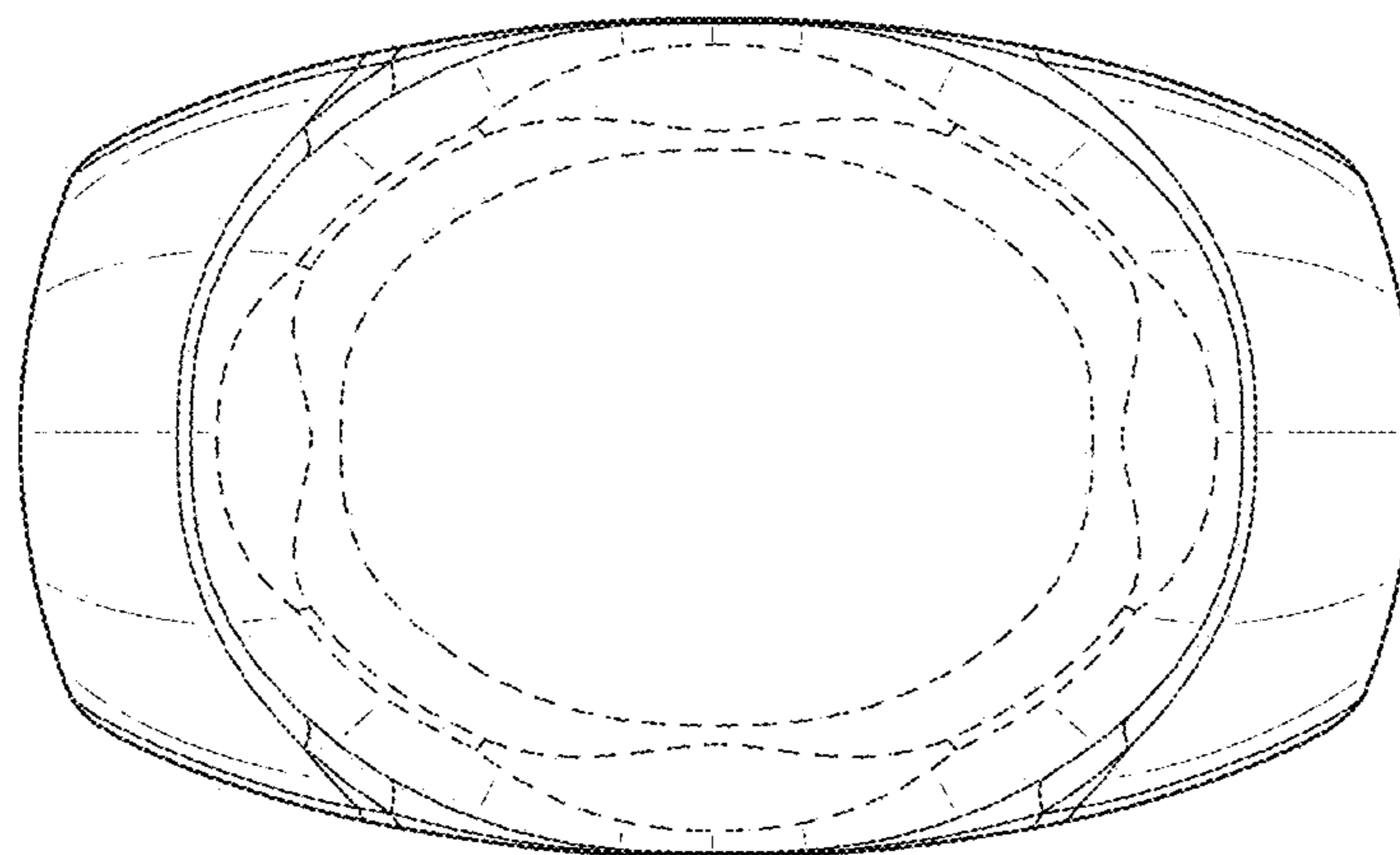

FIG. 14



FIG. 15

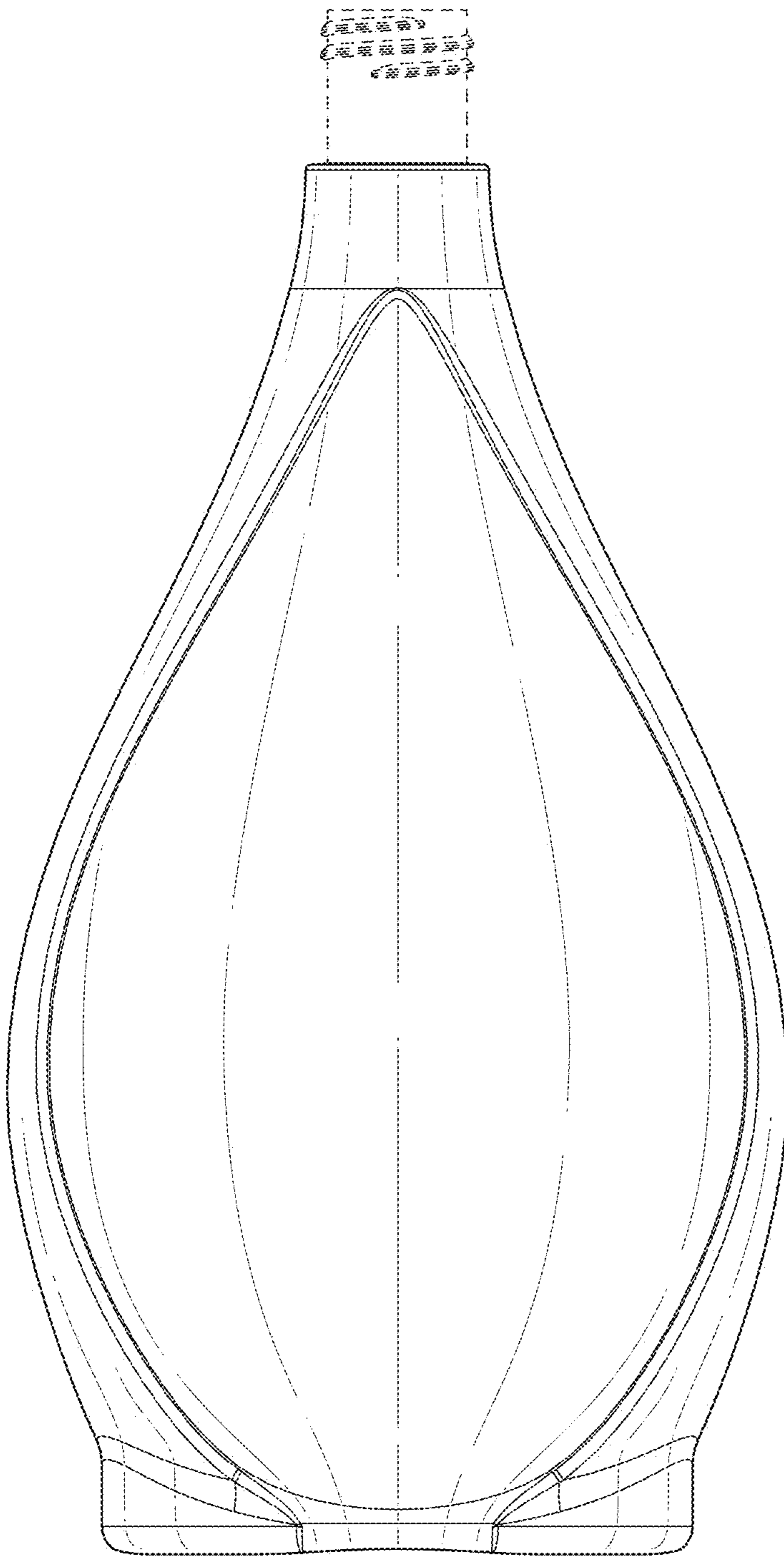

FIG. 16

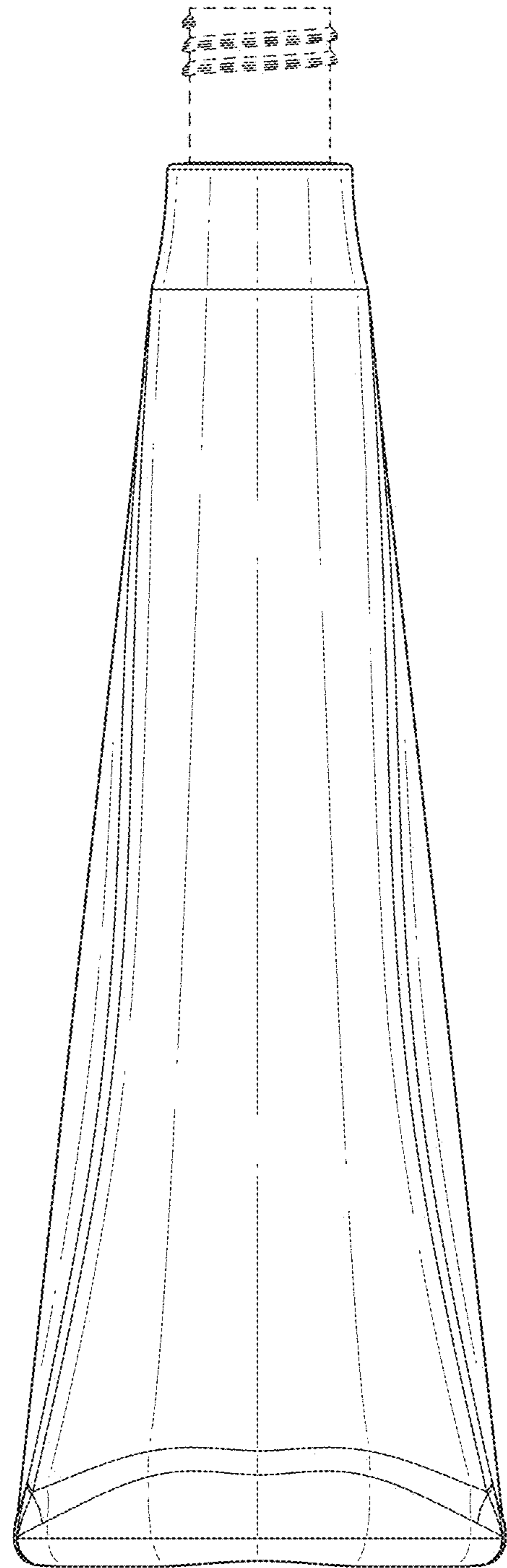

FIG. 17

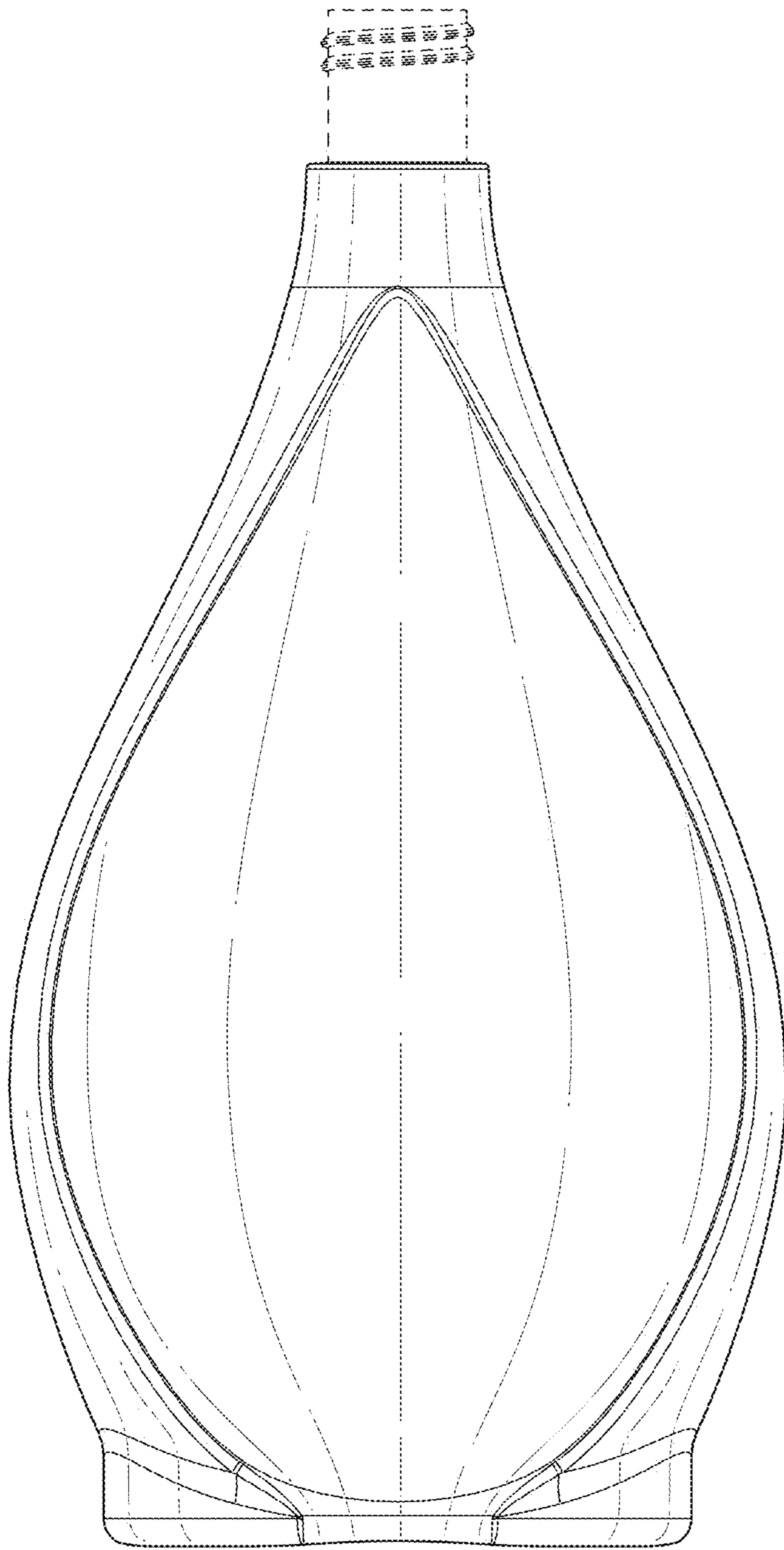

FIG. 18

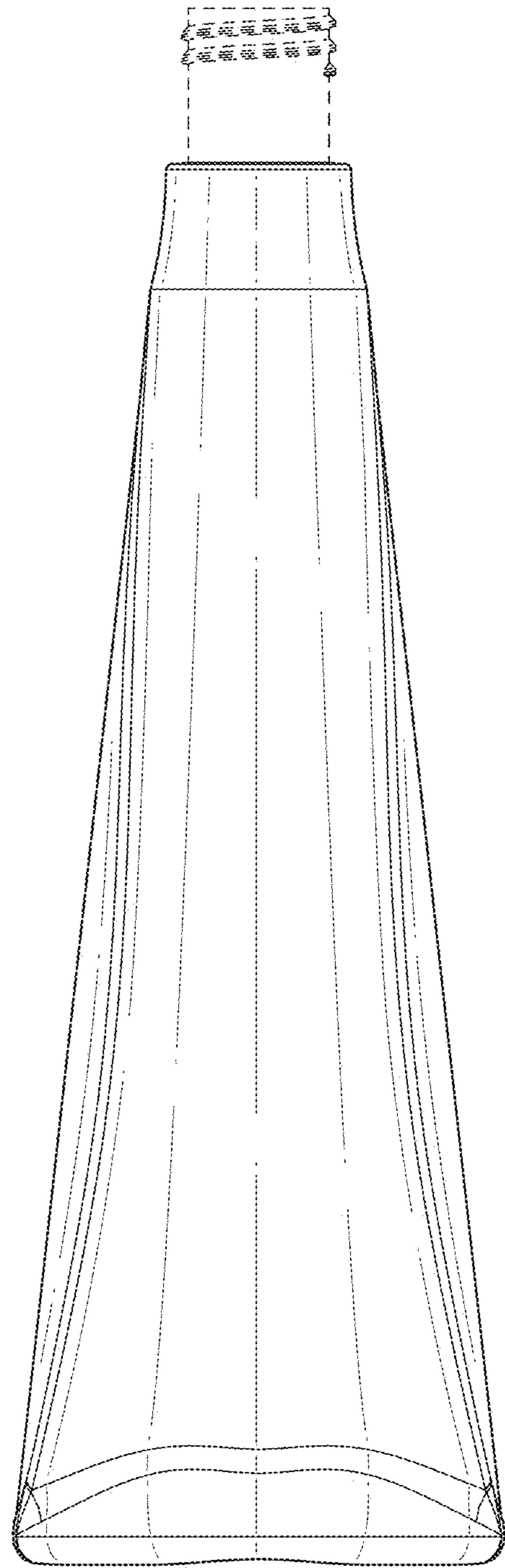

FIG. 19

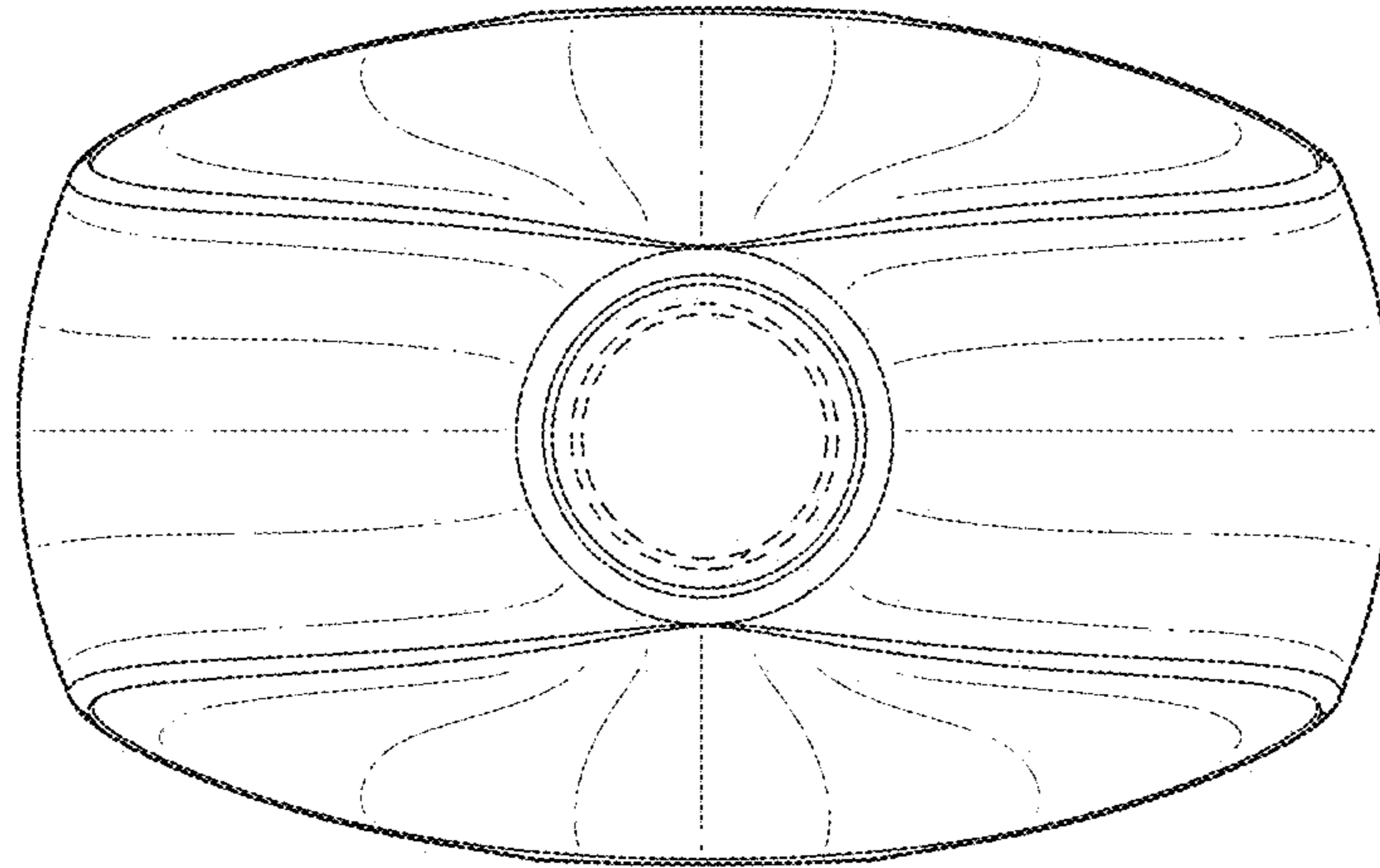

FIG. 20

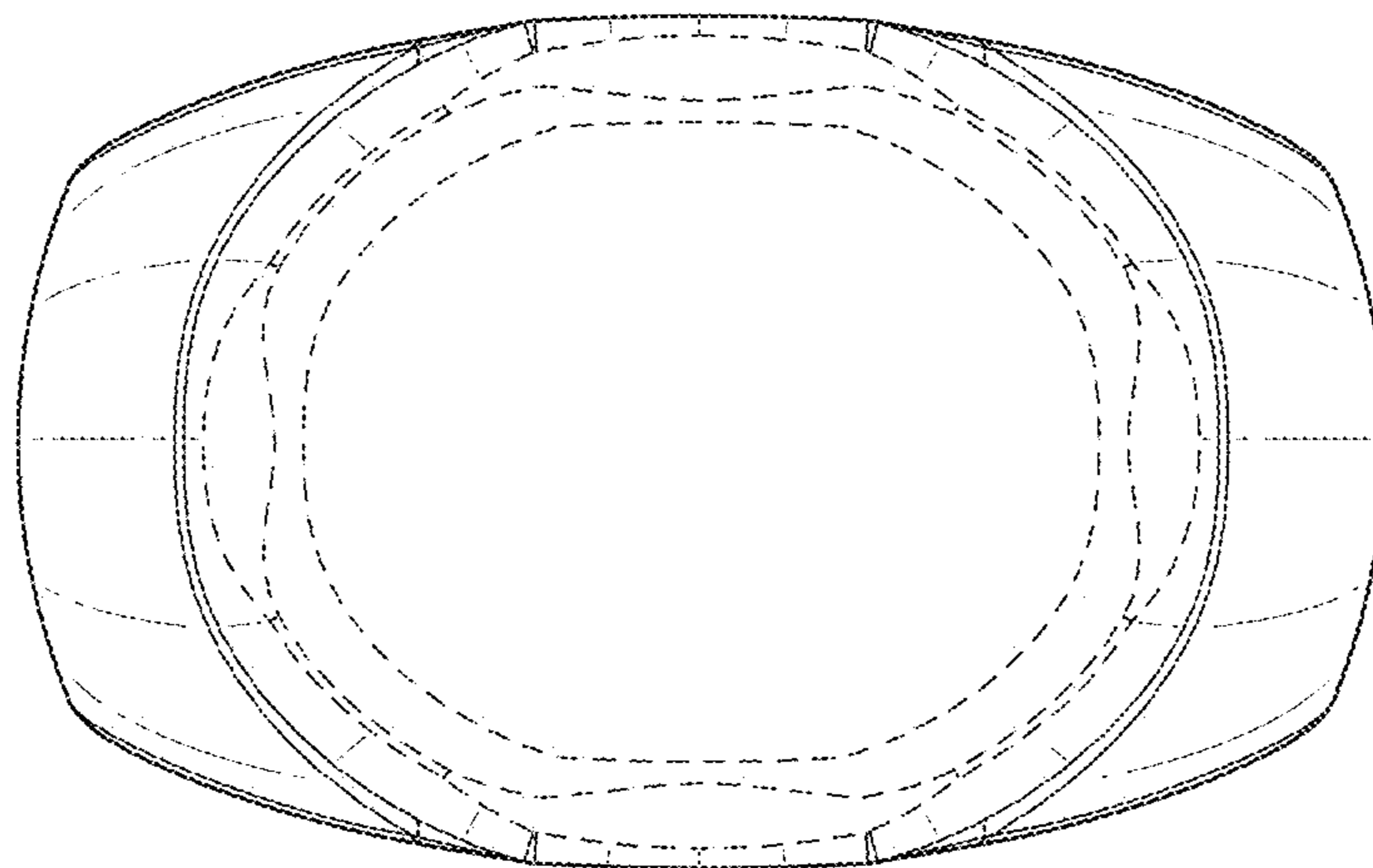

FIG. 21