



US00D920046S

(12) **United States Design Patent** (10) **Patent No.:** **US D920,046 S**
Backs (45) **Date of Patent:** **** May 25, 2021**

(54) **CONTAINER CAP WITH DRINK VESSEL**

FOREIGN PATENT DOCUMENTS

(71) Applicant: **CamelBak Products, LLC**, Petaluma, CA (US)

CN 207506321 U 6/2018
EP 2754620 B1 1/2014

(Continued)

(72) Inventor: **Jochen Backs**, Mill Valley, CA (US)

OTHER PUBLICATIONS

(73) Assignee: **CamelBak Products, LLC**, Petaluma, CA (US)

“CamelBak Eddy+ Kids Bottle”. Found online Jun. 24, 2020 at amazon.com. Reference dated Dec. 24, 2019. Retrieved from https://www.amazon.com/CamelBak-2305102040-Eddy-Kids-Bones/dp/B07X97WW14/ref=cm_cr_ar_p_d_product_top?ie=UTF8.*

(**) Term: **15 Years**

(Continued)

(21) Appl. No.: **29/692,219**

(22) Filed: **May 23, 2019**

Primary Examiner — Kendra Leslie Hamilton

(51) **LOC (13) Cl.** **07-01**

(74) *Attorney, Agent, or Firm* — Amardeep S. Grewal; Gerard M. Donovan; Reed Smith LLP

(52) **U.S. Cl.**

USPC **D7/510**

(58) **Field of Classification Search**

USPC D7/391, 392, 392.1, 396.1, 396.2, 397, D7/509, 510, 543, 629; D9/435, 443, D9/447, 449, 516

(57) **CLAIM**

CPC ... B65D 47/066; B65D 47/305; B65D 47/122
See application file for complete search history.

The ornamental design for a container cap with drink vessel, as shown and described.

(56) **References Cited**

DESCRIPTION

U.S. PATENT DOCUMENTS

5,007,555 A	4/1991	Beck	
5,188,283 A	2/1993	Gu	
5,203,468 A	4/1993	Hsu	
5,873,478 A *	2/1999	Sullivan	B65D 47/305 215/389
5,908,126 A	6/1999	Wang	
5,950,848 A	9/1999	Baudin	
6,390,341 B1	5/2002	Ohmi et al.	
6,523,711 B1 *	2/2003	Hughes	A47G 19/2266 215/308
7,059,490 B2	6/2006	Son	
7,128,227 B2	10/2006	Skillin et al.	
7,766,057 B2	8/2010	Windmiller	
D626,837 S	11/2010	Meyers et al.	
8,006,853 B2	8/2011	Delage	
8,430,284 B2	4/2013	Broadbent et al.	

(Continued)

FIG. 1 is a front, top isometric view of a container cap with drink vessel, showing my new design.
FIG. 2 is a rear, top isometric view thereof.
FIG. 3 is a front elevation view thereof.
FIG. 4 is a rear elevation view thereof.
FIG. 5 is a right side elevation view thereof.
FIG. 6 is a left side elevation view thereof.
FIG. 7 is a top plan view thereof.
FIG. 8 is a bottom plan view thereof.
FIG. 9 is a front, bottom isometric view thereof; and,
FIG. 10 is a rear, bottom isometric view thereof.
The broken lines in the drawings depict portions of the container cap with drink vessel that form no part of the claimed design.

1 Claim, 9 Drawing Sheets

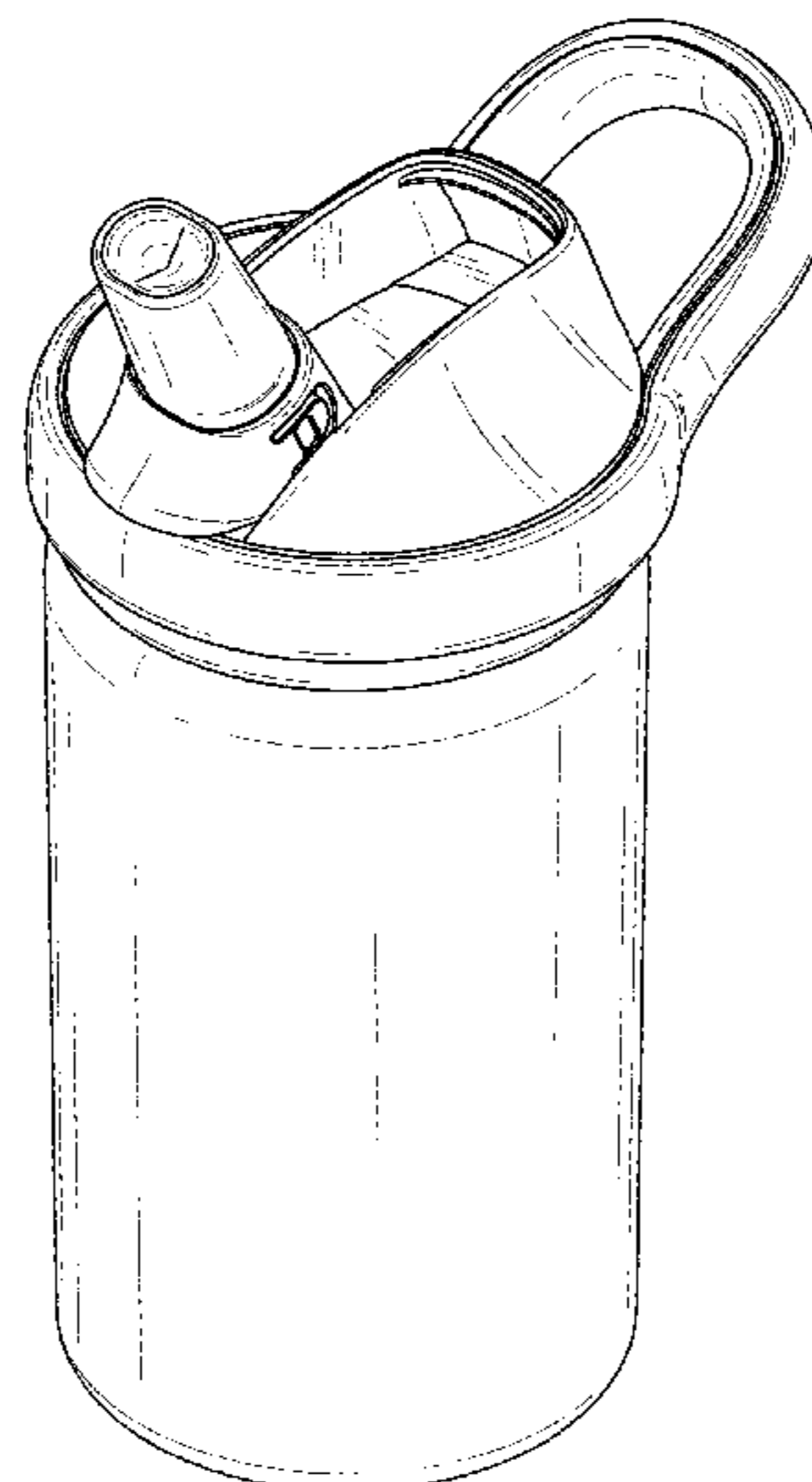

(56)

References Cited

U.S. PATENT DOCUMENTS

8,434,639 B2 5/2013 Markert
 D683,581 S * 6/2013 Archer D7/392.1
 8,602,238 B2 12/2013 El Saden et al.
 8,672,174 B1 3/2014 McMullin
 D704,986 S * 5/2014 Manies D7/392.1
 8,827,106 B2 9/2014 Windmiller
 D720,184 S * 12/2014 Gilbert D7/300.1
 D729,569 S 5/2015 Herbst et al.
 9,120,606 B2 9/2015 Walter et al.
 9,162,802 B2 10/2015 El Saden et al.
 D748,430 S 2/2016 Sorensen et al.
 D756,702 S 5/2016 Joseph et al.
 9,380,898 B2 7/2016 Mason
 9,392,893 B2 7/2016 Sorensen et al.
 D763,688 S 8/2016 Breit et al.
 D767,336 S 9/2016 Waggoner et al.
 9,708,107 B2 7/2017 El-Saden et al.
 D793,154 S 8/2017 Sorensen et al.
 9,790,007 B2 10/2017 Sorensen et al.
 9,844,285 B2 12/2017 Hoskins
 D810,502 S 2/2018 Joseph et al.
 D811,162 S * 2/2018 Rane D9/449
 D811,810 S 3/2018 Joseph et al.
 D812,966 S * 3/2018 Murosky D7/392.1
 D817,088 S 5/2018 Shirley
 D818,768 S 5/2018 Joseph et al.
 D818,774 S 5/2018 Stover
 D820,637 S 6/2018 Davis
 D855,388 S * 8/2019 Potter D7/392.1
 D862,985 S * 10/2019 Backs D7/511
 D870,508 S * 12/2019 Palkon D7/392.1
 D881,643 S * 4/2020 Fleischhut D7/396.2
 2004/0040979 A1 3/2004 Frantz et al.
 2008/0272122 A1 11/2008 Son
 2009/0084814 A1 4/2009 Wisniewski et al.
 2010/0193462 A1 * 8/2010 Roth B65D 81/18
 215/229
 2012/0187075 A1 7/2012 El-Saden et al.
 2012/0305559 A1 12/2012 Steininger
 2014/0138395 A1 * 5/2014 Joy B65D 47/305
 220/715
 2016/0166094 A1 6/2016 Tebbe et al.
 2016/0207672 A1 7/2016 Wong
 2017/0253394 A1 9/2017 Fogarty et al.
 2017/0253395 A1 9/2017 Matthis
 2017/0313478 A1 11/2017 El-Saden et al.

2018/0192800 A1 7/2018 Coon et al.
 2018/0208366 A1 7/2018 Fang
 2018/0215515 A1 8/2018 Cervený

FOREIGN PATENT DOCUMENTS

WO WO 98/02363 1/1998
 WO WO 2006/055868 A1 5/2006

OTHER PUBLICATIONS

“Contigo Addison Waterbottle”. Found online May 15, 2020 at amazon.co.uk. Reference dated Jun. 24, 2011. Retrieved from https://www.amazon.co.uk/...53FFGHY/ref=sr_1_21?crid=3RSVDAKWD8BN7&dchild=1&keywords=contigo+addison&qid=1589570808&sprefix=contigo+add%2Caps%2C226&sr=8-21.
 “Unibos Flip Straw Water Bottle”. Found online Jan. 3, 2020 at amazon.co.uk. Reference dated Apr. 25, 2015. Retrieved from https://www.amazon.co.uk/Unibos-Tritan-Drinks-Hydration-Cycling/dp/B00WODRMZC/ref=sr_1_149?dchild=1&keywords=STRAW+bottle&qid=1578082044&sr=8-149.
 English-language machine translation of China Utility Model Publication No. CN 207506321 U, European Patent Office, Jul. 2, 2018. CamelBak 2018 eddy 1L Water Bottle, https://www.camelbak.com/en/bottles/R02002--eddy_1L?color=0d6b2cefdb354443bc429222885bfb87, retrieved Jun. 3, 2019.
 CamelBak eddy+ 6L Bottle, https://www.camelbak.com/en/bottles/R02059--Eddy_6L_2019?color=09e6b07a54714912bebd3bc8f3b8f7d8, retrieved Jun. 3, 2019.
 CamelBak eddy Kids .4L Bottle, Insulated, https://www.camelbak.com/en/bottles/R02008--eddy_Kids_Insulated_4L?color=d3ba7722203a4d89824132c95b8ec370, retrieved Jun. 3, 2019.
 Contigo Kids Autospout Gizmo Water Bottles, https://www.amazon.com/Contigo-Autospout-Bottles-Nautical-School/dp/B071DYRL2N/ref=sr_1_3?keywords=Contigo+kids&qid=1559584259&s=gateway&sr=8-3 retrieved Jun. 3, 2019.
 Zak Riverside 16 oz. Water Bottle, https://www.zak.com/riverside-surf-boards-water-bottles_6818-T340, retrieved Apr. 1, 2019.
 Zak Toddlerific 11 oz. Water Bottle, <https://www.zak.com/bird-water-bottle-for-toddlers-6710-R722> retrieved Apr. 1, 2019.
 CamelBak Eddy Water Bottle, posted at Amazon.com, posted on Jan. 5, 2019, © 1996-2019 Amazon.com, [online], [site visited May 13, 2019]. Available from Internet, URL: <https://www.amazon.co.uk/Camelbak-Unisex-Adult-Water-Bottle/dp/B07HGSLDNQ/> (Year: 2019).

* cited by examiner



FIG. 1

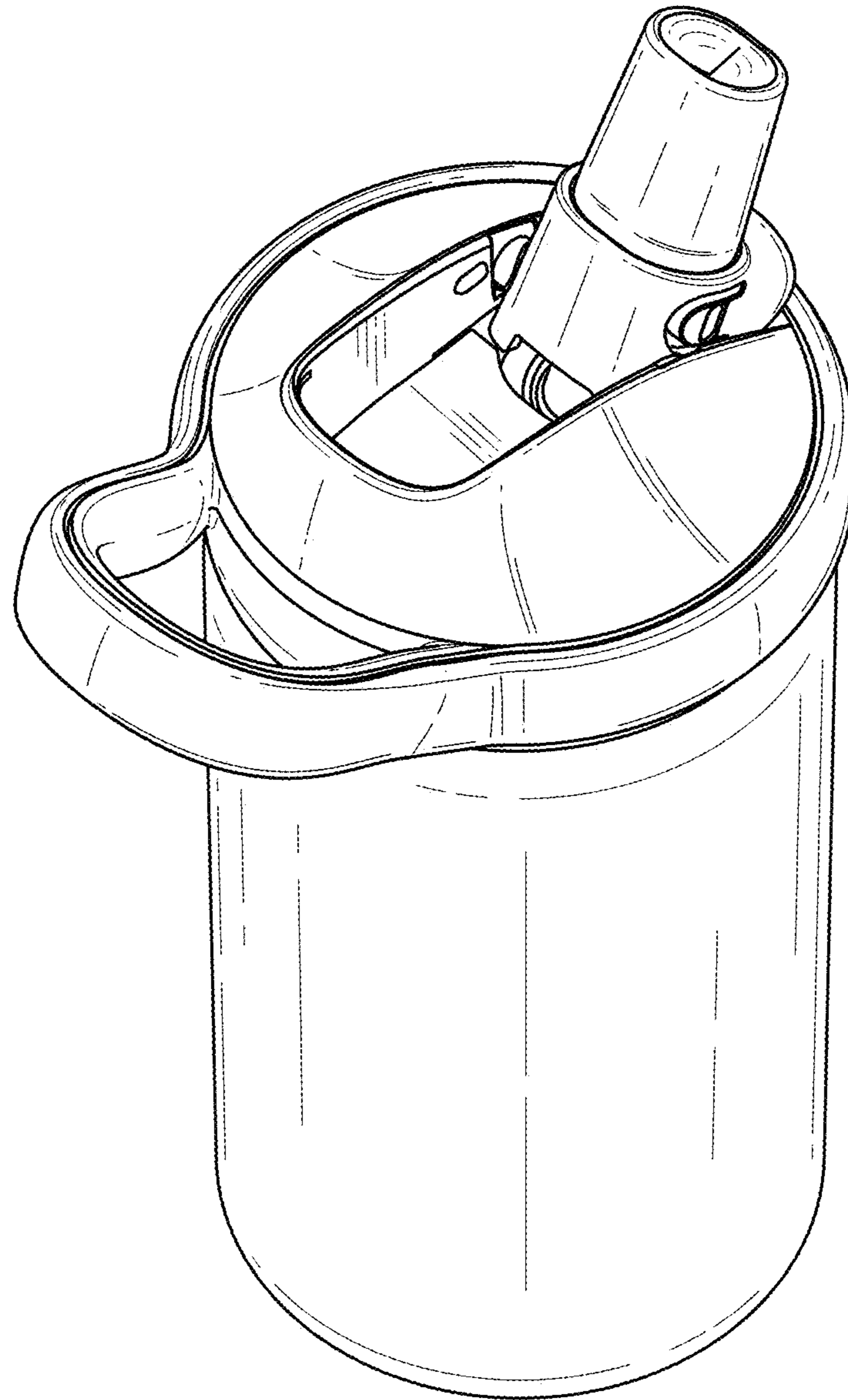

FIG. 2

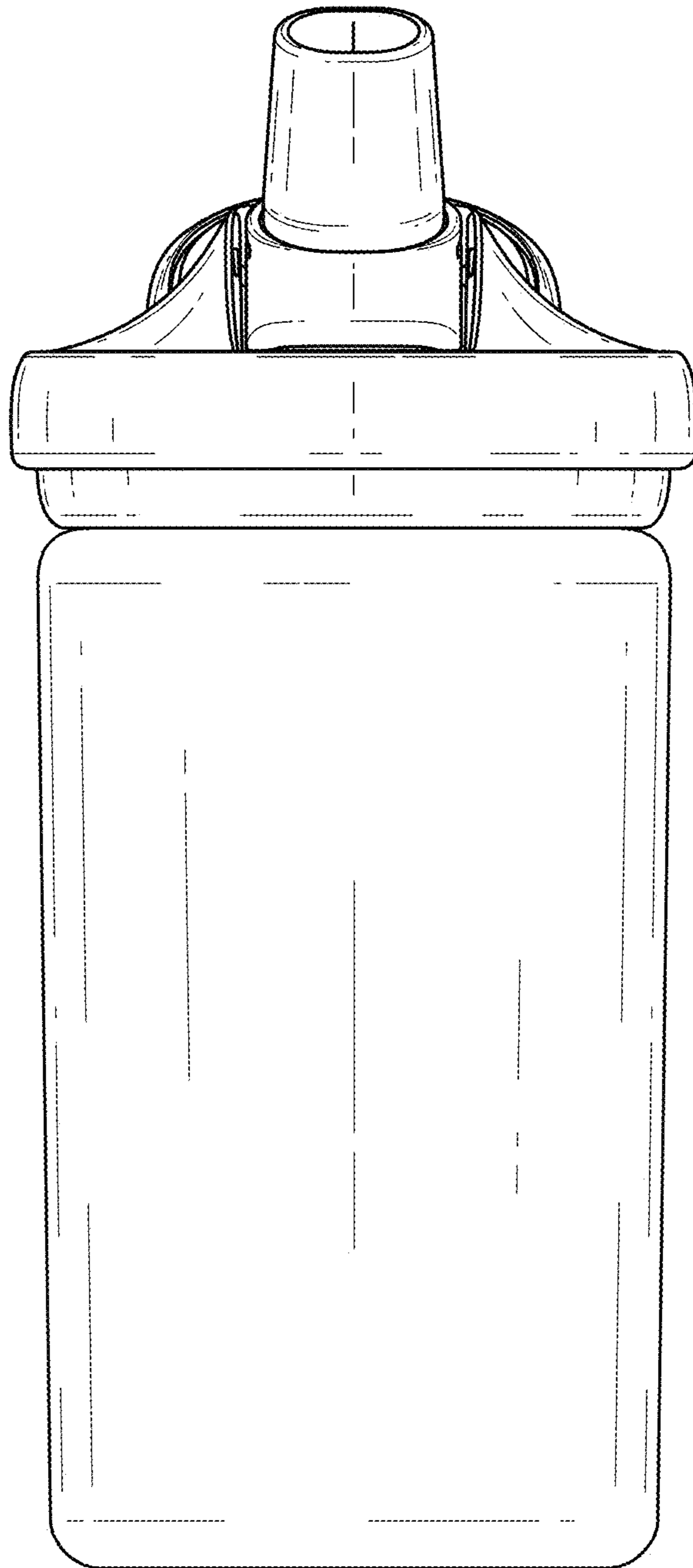

FIG. 3

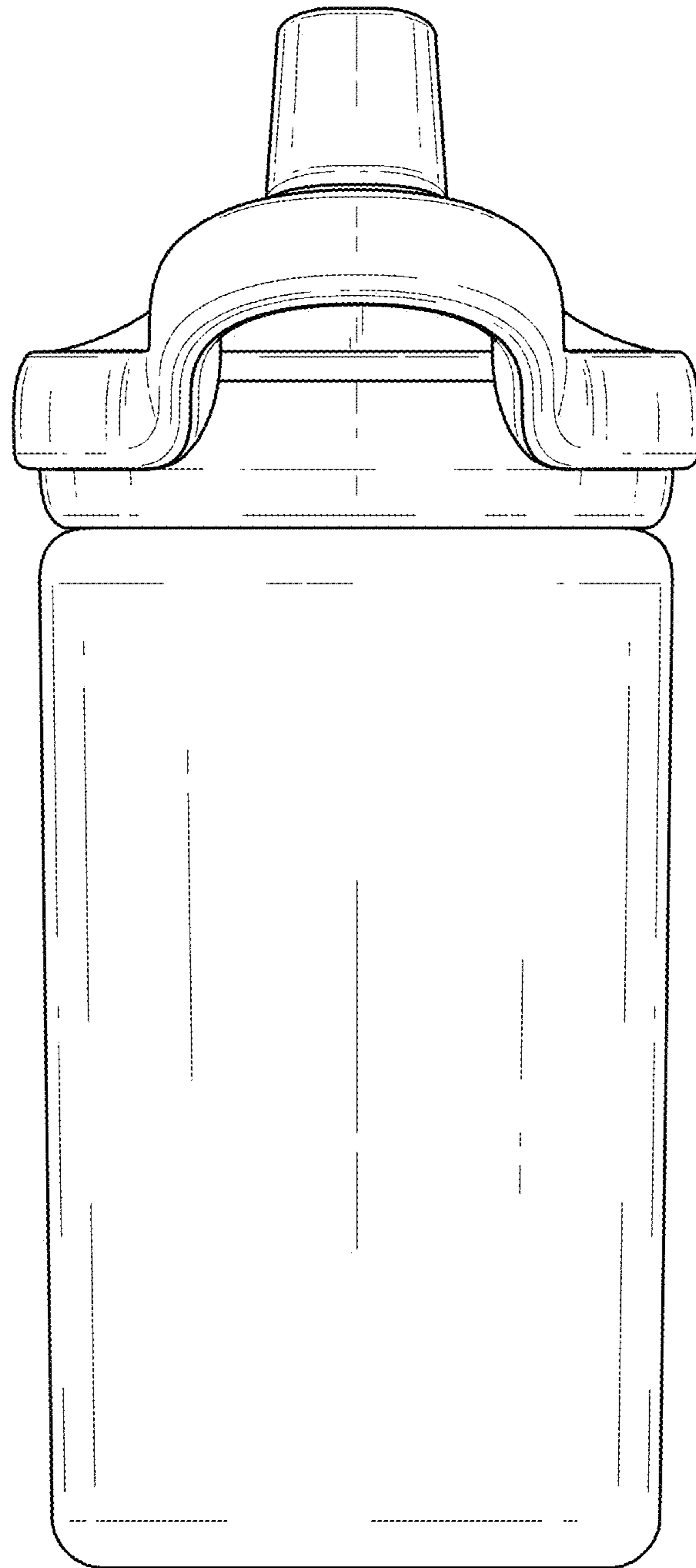

FIG. 4

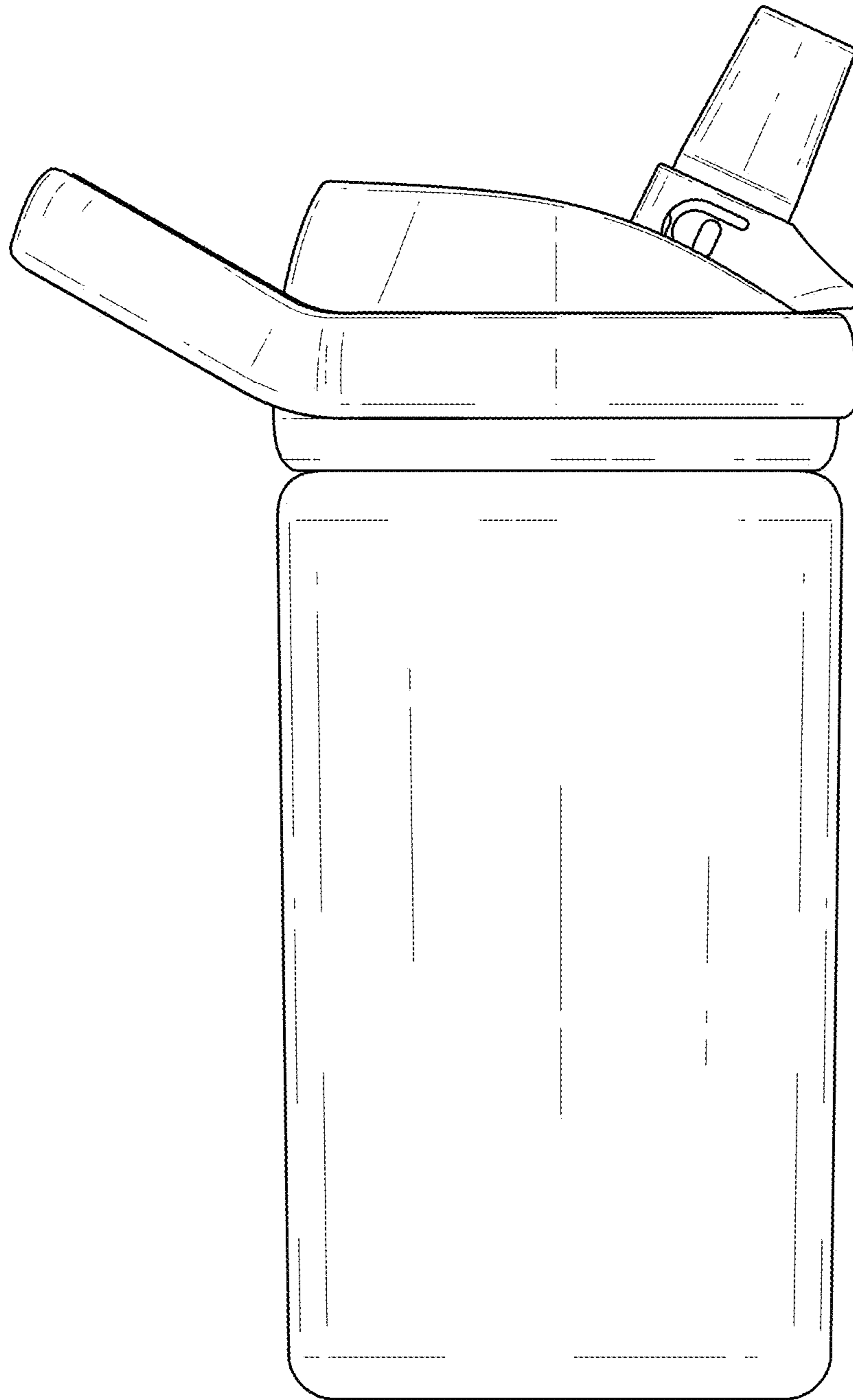

FIG. 5

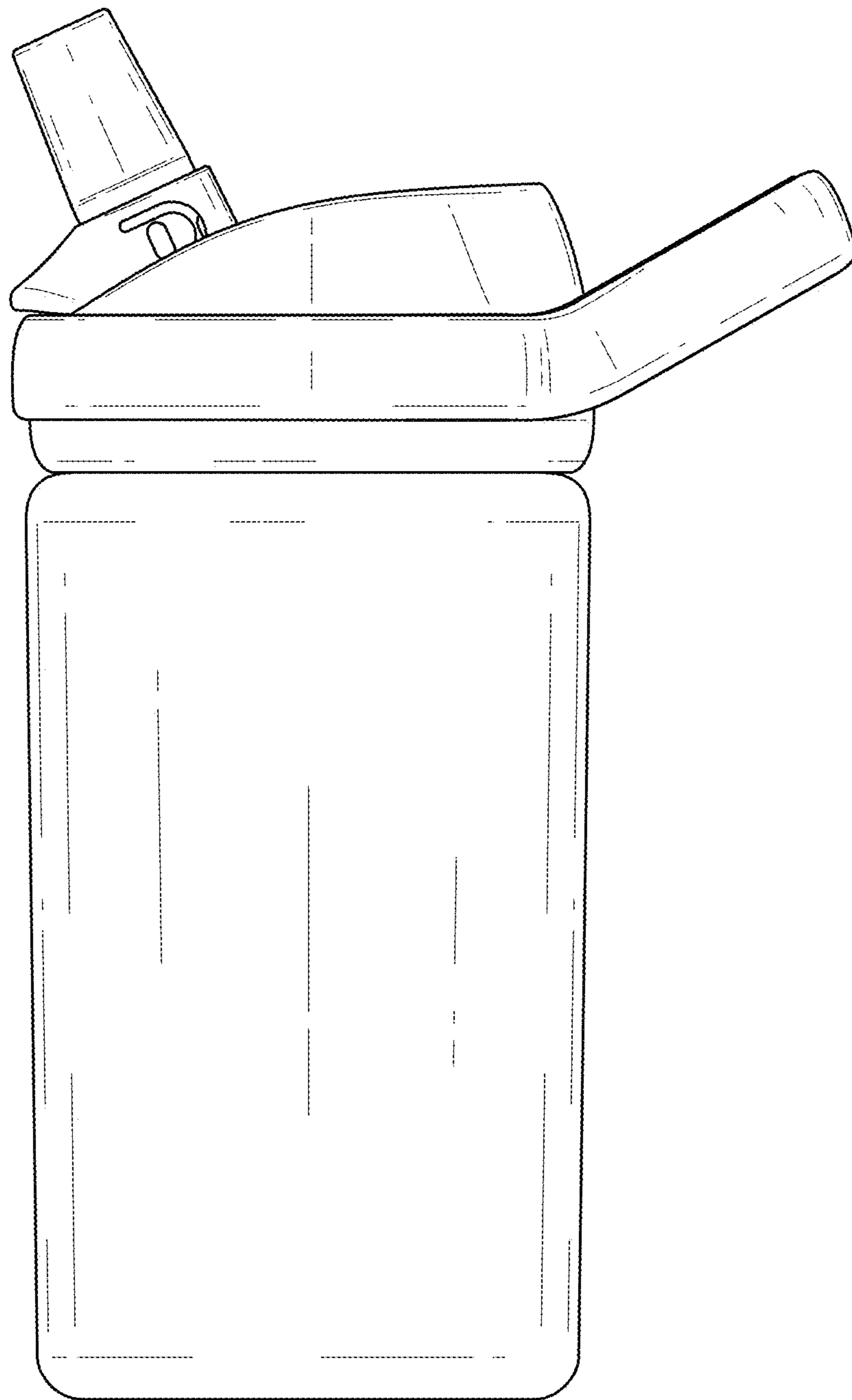

FIG. 6

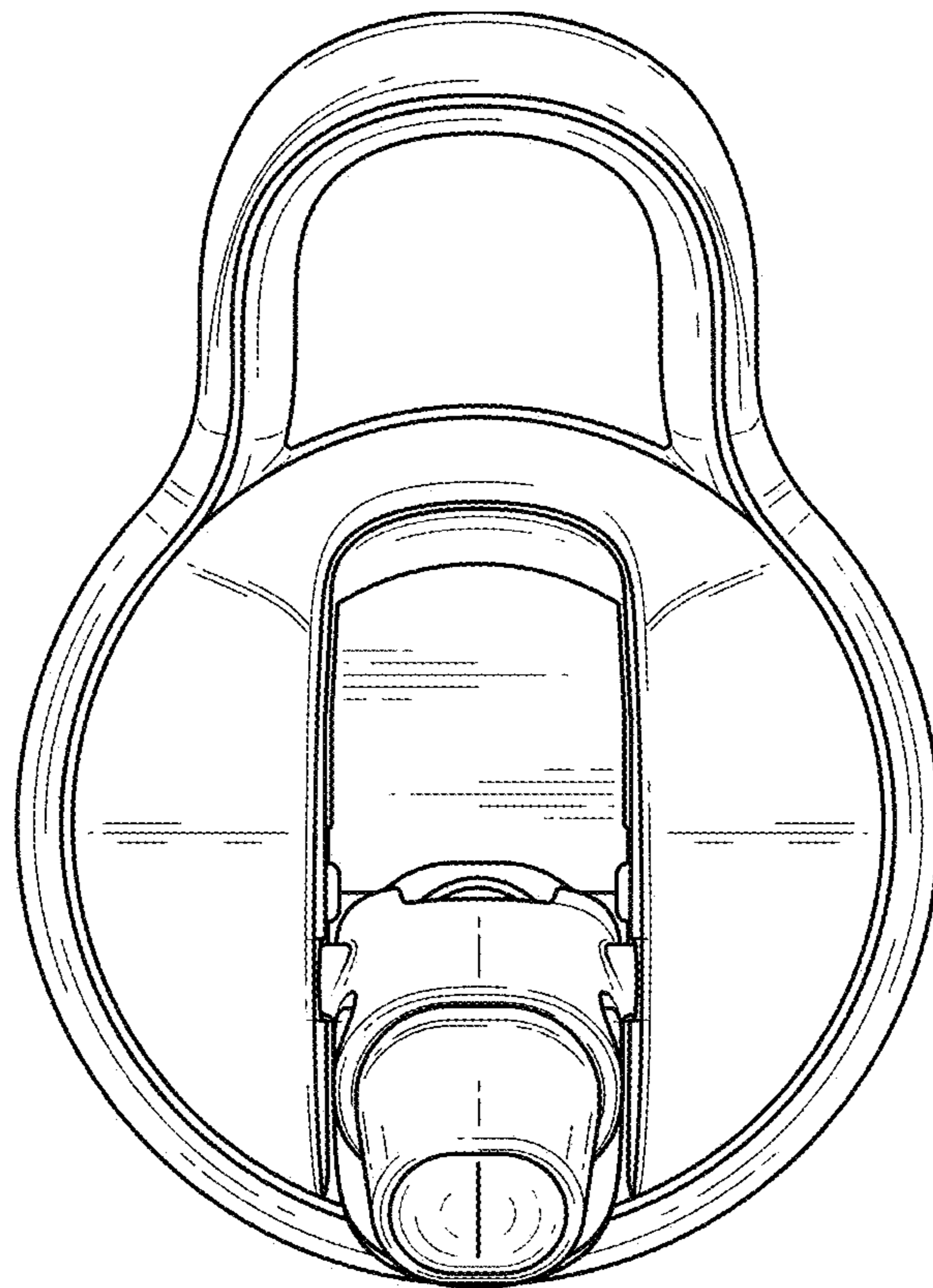

FIG. 7

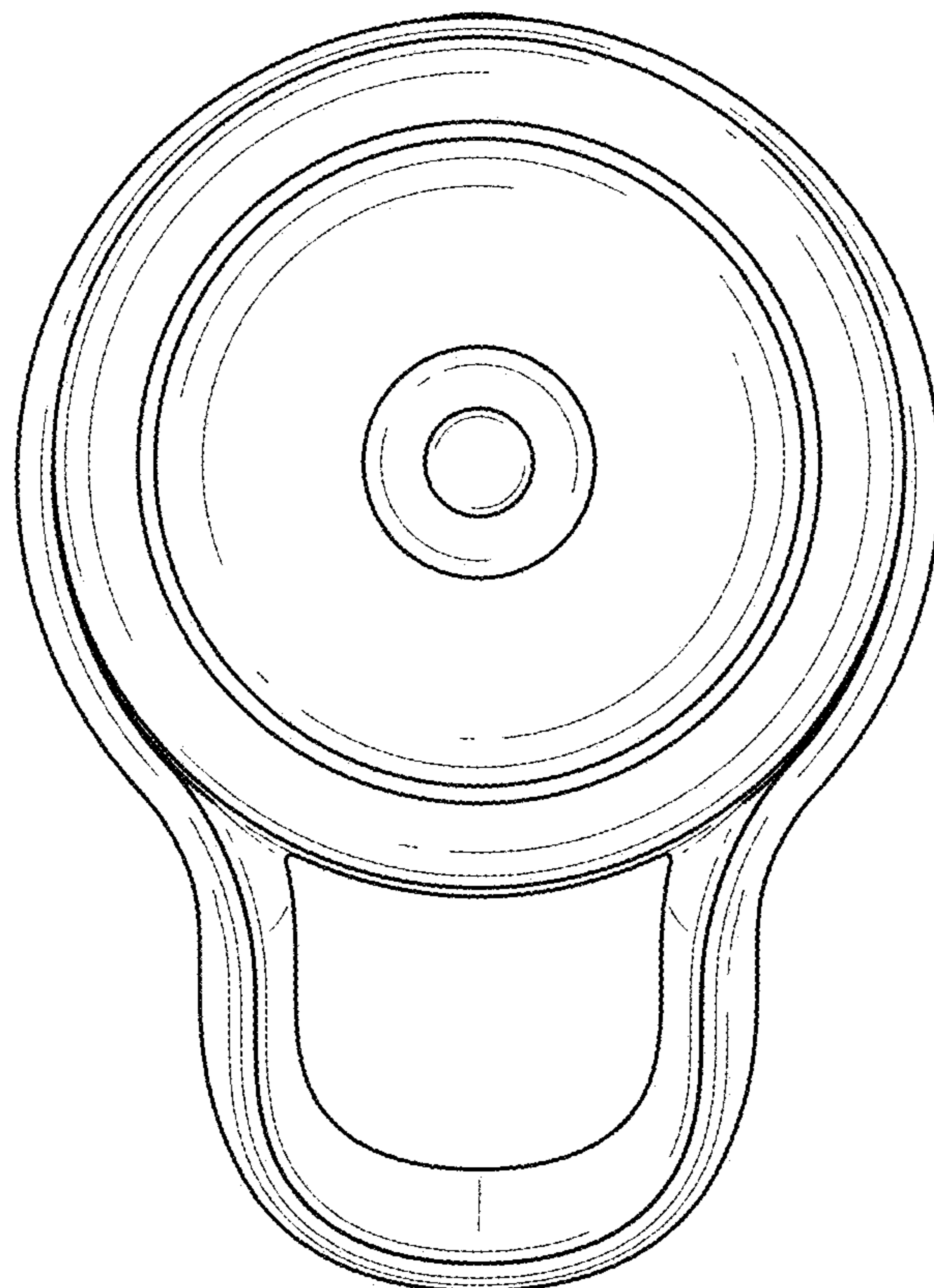

FIG. 8

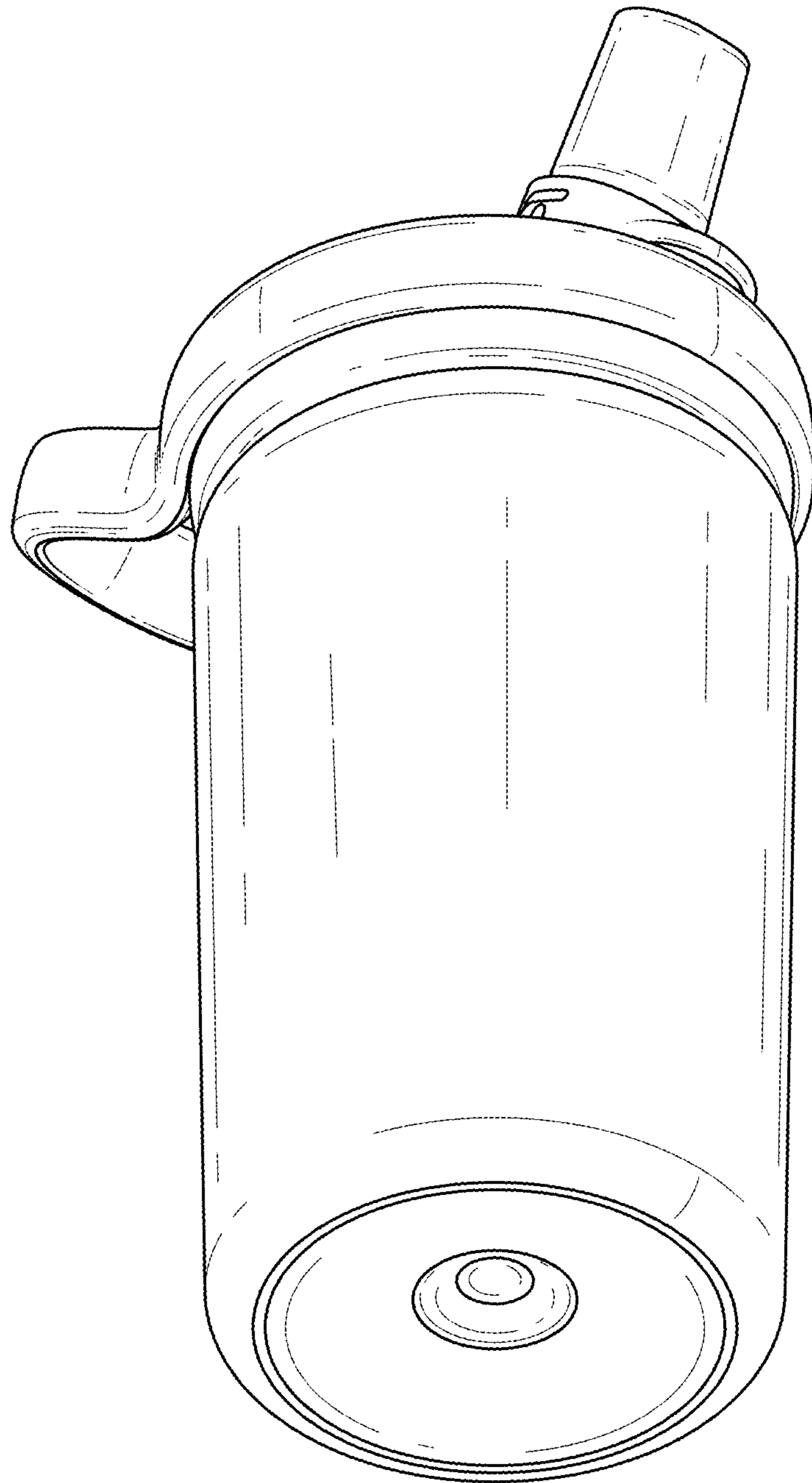

FIG. 9

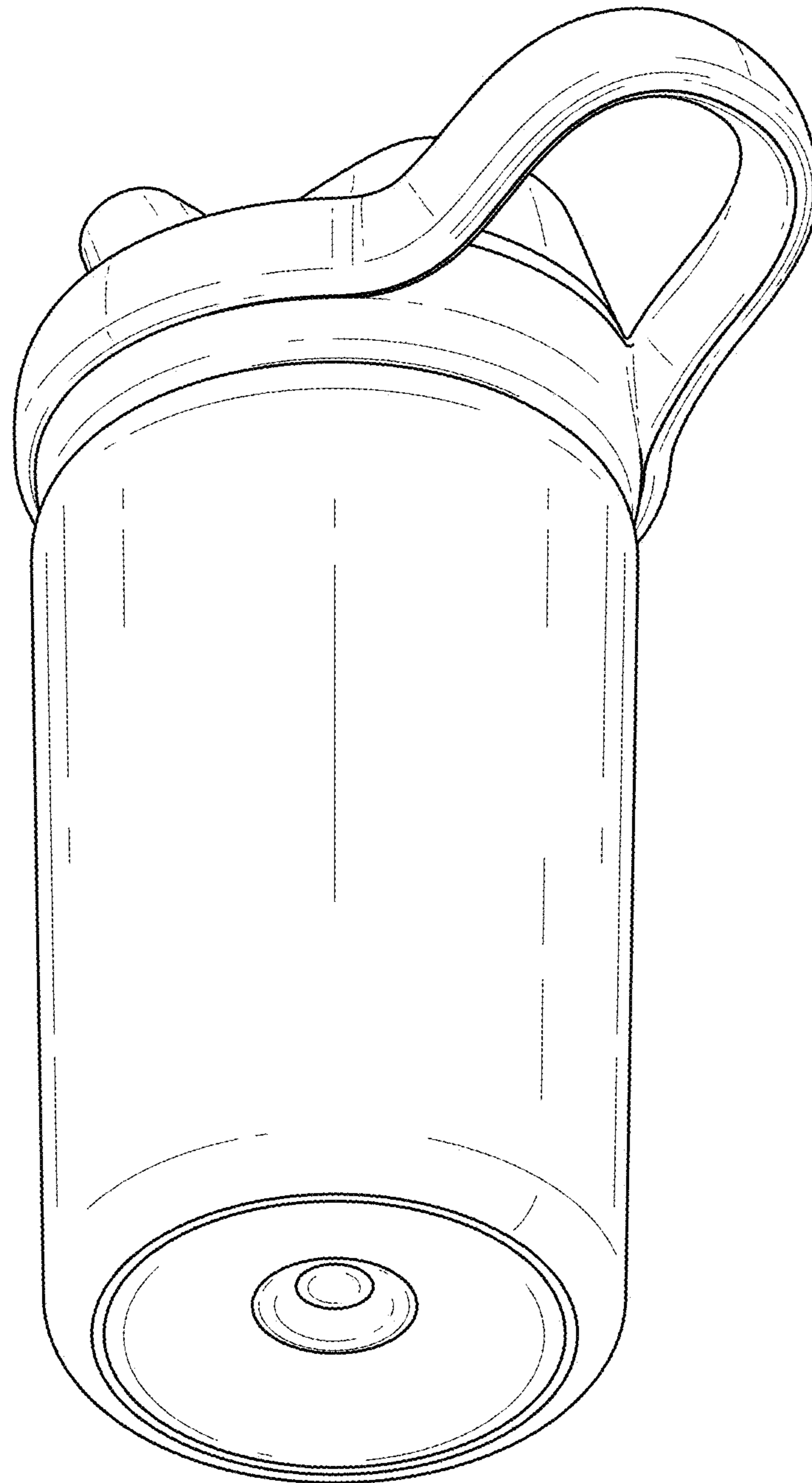

FIG. 10