



US00D920026S

(12) **United States Design Patent**  
**Kim et al.**

(10) **Patent No.:** **US D920,026 S**

(45) **Date of Patent:** **\*\* May 25, 2021**

(54) **INDUCTION RANGE**

(71) Applicant: **Samsung Electronics Co., Ltd.**,  
Suwon-si (KR)

(72) Inventors: **Daejong Kim**, Suwon-si (KR);  
**Yoonjoo Kwon**, Suwon-si (KR);  
**Gisung Han**, Suwon-si (KR); **Jaejun Kim**,  
Suwon-si (KR)

(73) Assignee: **Samsung Electronics Co., Ltd.**,  
Suwon-si (KR)

(\*\*) Term: **15 Years**

(21) Appl. No.: **29/708,550**

(22) Filed: **Oct. 8, 2019**

(30) **Foreign Application Priority Data**

Apr. 8, 2019 (KR) ..... 30-2019-0016443

(51) **LOC (13) Cl.** ..... **07-02**

(52) **U.S. Cl.**  
USPC ..... **D7/346**

(58) **Field of Classification Search**  
USPC ..... D7/323, 337, 339, 340, 341, 346, 350.3,  
D7/352, 354, 355, 356, 357, 358, 359,  
(Continued)

(56) **References Cited**

**U.S. PATENT DOCUMENTS**

4,173,823 A \* 11/1979 Anderson ..... A21B 1/52  
29/611  
D621,205 S \* 8/2010 Yeung ..... D7/367  
(Continued)

**FOREIGN PATENT DOCUMENTS**

CN 201730187043 9/2017  
CN 201730130908 10/2017  
(Continued)

**OTHER PUBLICATIONS**

Samsung Portable Slim Double Induction Cooktop, announced Jan. 8, 2020 [online], retrieved Dec. 2, 2020, retrieved from internet, <http://www.dudeiwantthat.com/household/kitchen/samsung-portable-slim-double-induction-cooktop.asp>.\*

(Continued)

*Primary Examiner* — Dana K Weiland

*Assistant Examiner* — Messina L Smith

(74) *Attorney, Agent, or Firm* — NSIP Law

(57) **CLAIM**

We claim the ornamental design for an induction range, as shown and described.

**DESCRIPTION**

FIG. 1 is a front perspective view of a first embodiment of an induction range showing our new design;

FIG. 2 is a front view thereof;

FIG. 3 is a rear view thereof;

FIG. 4 is a left-side view thereof;

FIG. 5 is a right-side view thereof;

FIG. 6 is a top view thereof;

FIG. 7 is a bottom view thereof;

FIG. 8 is an enlarged view of the encircled portion in FIG. 4;

FIG. 9 is a front perspective view of the induction range in a state of use;

FIG. 10 is an exploded view thereof showing the induction range in a state of use;

FIG. 11 is a front perspective view of a second embodiment of the induction range showing our new design;

FIG. 12 is a front view thereof;

FIG. 13 is a rear view thereof;

FIG. 14 is a left-side view thereof;

FIG. 15 is a right-side view thereof;

FIG. 16 is a top view thereof;

FIG. 17 is a bottom view thereof; and,

FIG. 18 is an enlarged view of the encircled portion in FIG. 14.

(Continued)

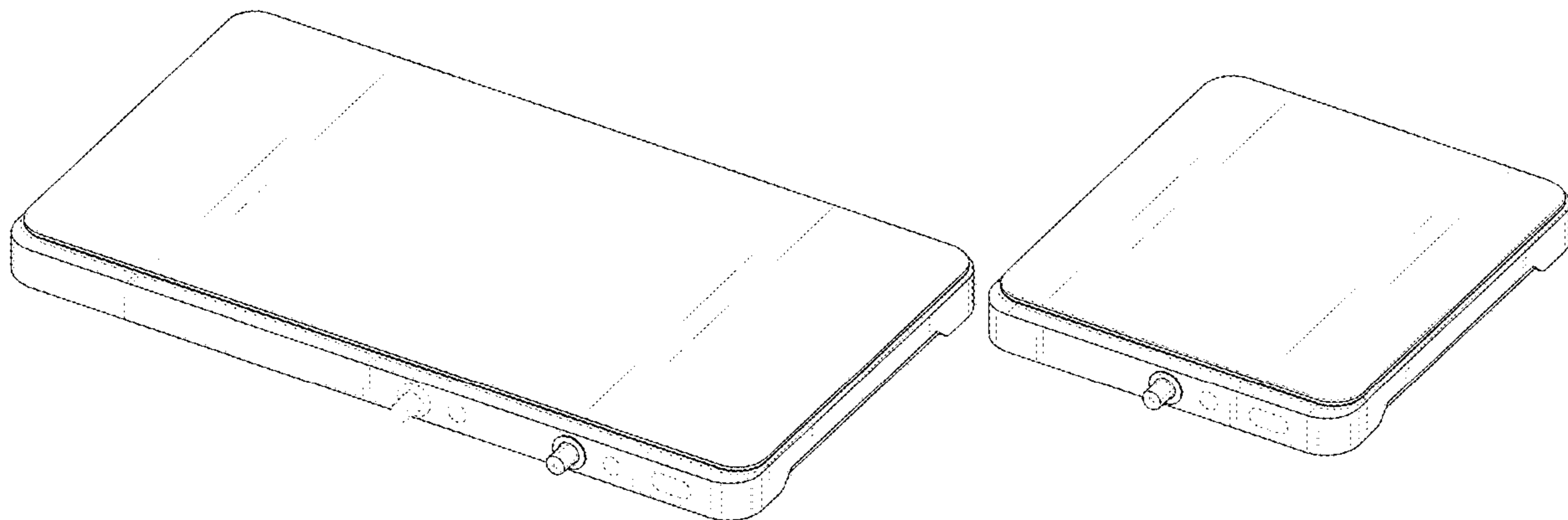

The evenly-dashed broken lines in the figures depict portions of the induction range that form no part of the claimed design.

The dot-dashed broken lines encircling portions of the claimed design that are shown in enlargements form no part of the claimed design.

**1 Claim, 14 Drawing Sheets**

(58) **Field of Classification Search**

USPC ..... D7/360, 361, 362, 363, 364, 365, 366, D7/367, 402, 403, 406, 407, 601; D14/341, 343, 358, 432, 453, 138 AA, D14/138 G, 155; D10/49; D13/162, D13/162.1

CPC ..... A21B 1/06; A21B 1/50; A21B 1/52; A47J 37/04; A47J 37/06; A47J 37/015; A47J 37/067; A47J 37/0611; A47J 37/0629; A47J 37/0676; A47J 37/108; F24C 7/06; F24C 7/083; F24C 15/02; F24C 15/66; H05B 3/20; H05B 3/40

See application file for complete search history.

(56) **References Cited**

U.S. PATENT DOCUMENTS

D658,429 S \* 5/2012 Berge ..... D7/363  
 D678,875 S \* 3/2013 Chen ..... D14/341  
 D689,483 S \* 9/2013 Wu ..... D14/358  
 D692,420 S \* 10/2013 McManigal ..... D14/341  
 D696,894 S \* 1/2014 Meda ..... D7/346  
 D704,506 S \* 5/2014 Boo ..... D7/402  
 D743,731 S \* 11/2015 Dumont ..... D7/346  
 D775,097 S \* 12/2016 Husgafvel ..... D14/138 G  
 D778,867 S \* 2/2017 Husgafvel ..... D14/138 G  
 D783,600 S \* 4/2017 Green ..... D14/341

D796,499 S \* 9/2017 Lee ..... D14/341  
 D807,348 S \* 1/2018 Wang ..... D14/341  
 D828,321 S \* 9/2018 Yeom ..... D14/138 AB  
 D836,384 S \* 12/2018 Hosoda ..... D7/363  
 D856,743 S \* 8/2019 Mano ..... D7/367  
 D864,949 S \* 10/2019 Akana ..... D14/341  
 D865,435 S \* 11/2019 Bassill ..... D7/363  
 D872,075 S \* 1/2020 Kim ..... D14/341  
 D873,819 S \* 1/2020 Harsacky ..... D14/348  
 D879,772 S \* 3/2020 Wall ..... D14/341  
 D881,830 S \* 4/2020 Fan ..... D14/138 AD  
 D883,944 S \* 5/2020 Matsuoka ..... D14/138 G  
 D883,945 S \* 5/2020 Park ..... D14/138 G  
 D884,412 S \* 5/2020 Tan ..... D7/363  
 2017/0142780 A1 \* 5/2017 Hoare ..... G01K 1/143  
 2018/0332998 A1 \* 11/2018 Schmidt ..... H05B 6/1209  
 2020/0370762 A1 \* 11/2020 Zhang ..... H05B 3/20

FOREIGN PATENT DOCUMENTS

CN 201730549847 5/2018  
 KR 30-2018-0012928 11/2018  
 KR 30-2018-0026042 2/2019  
 WO D205903-001 \* 9/2019

OTHER PUBLICATIONS

Samsung Portable Slim Double Induction is a sleek two-burner stove, announced Jan. 27, 2020 [online], retrieved Dec. 2, 2020, retrieved from internet, <https://dlmag.com/samsung-portable-slim-double-induction-is-a-sleek-two-burner-stove/>.\*

Samsung Portable Slim Double Induction, announced © 2003-2020 [online], retrieved Dec. 2, 2020, retrieved from internet, <https://www.ces.tech/Innovation-Awards/Honorees/2020/Honorees/S/Samsung-Portable-Slim-Double-Induction.aspx>.\*

Samsung Induction The Plate Cooktop, announced Jun. 18, 2020 [online], retrieved Dec. 2, 2020, retrieved from internet, <https://www.ebay.com/itm/Samsung-Induction-The-Plate-Cooktop-Black-NZ31T3703PK-Power-Booster-220V-60Hz-/333628822251>.\*

\* cited by examiner

FIG. 1

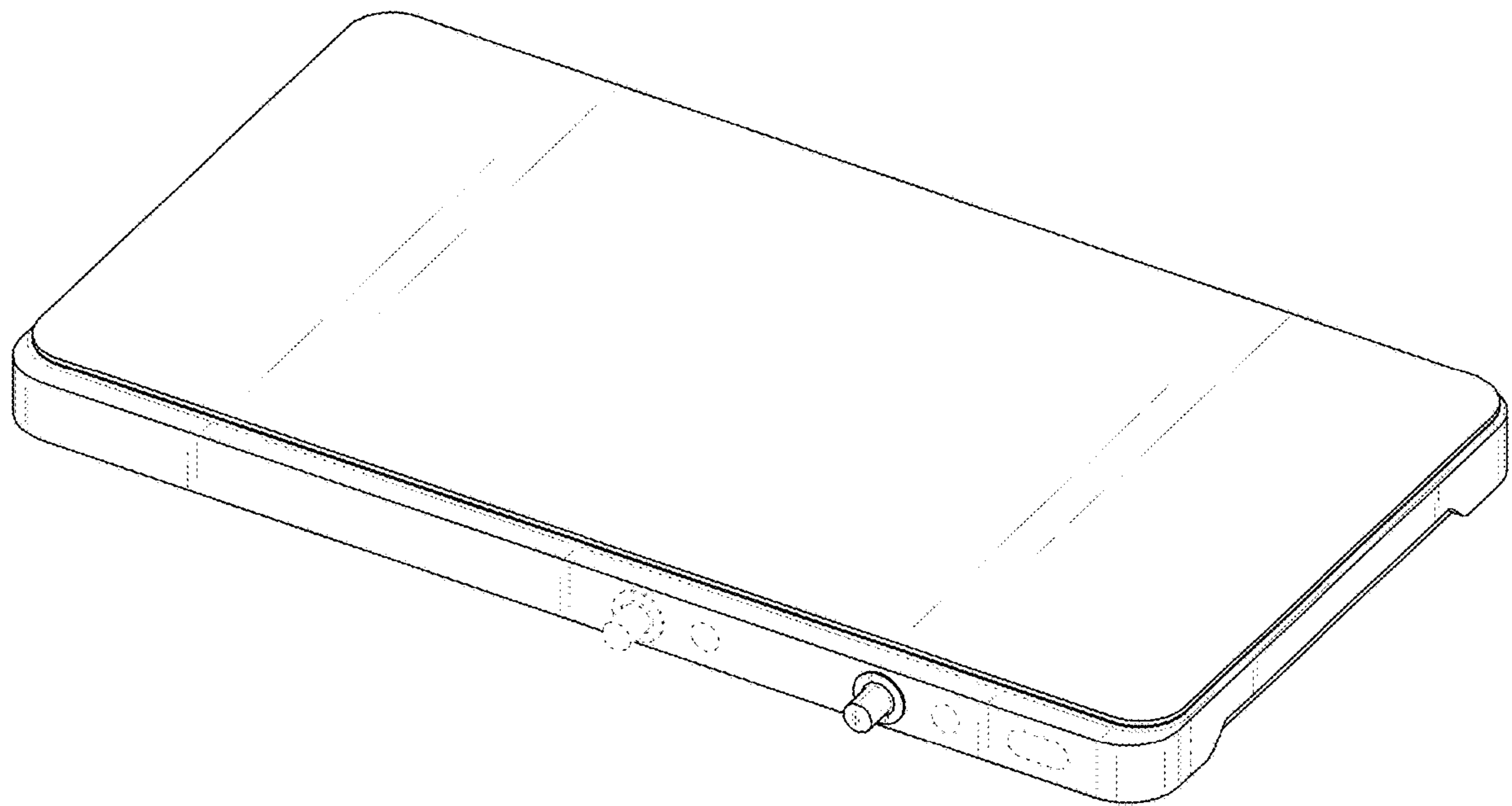

FIG. 2

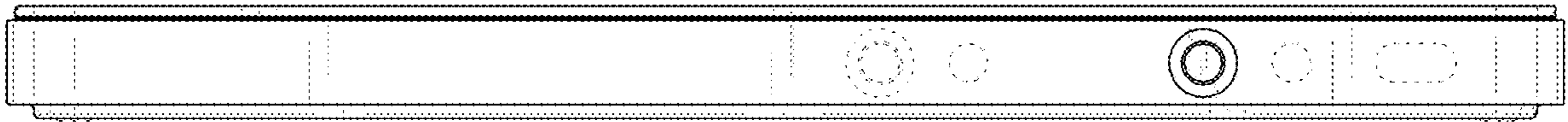

FIG. 3

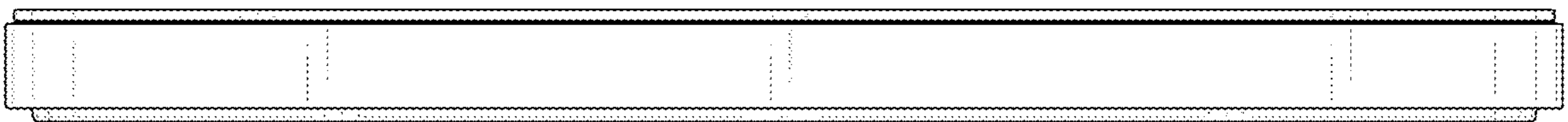

FIG. 4

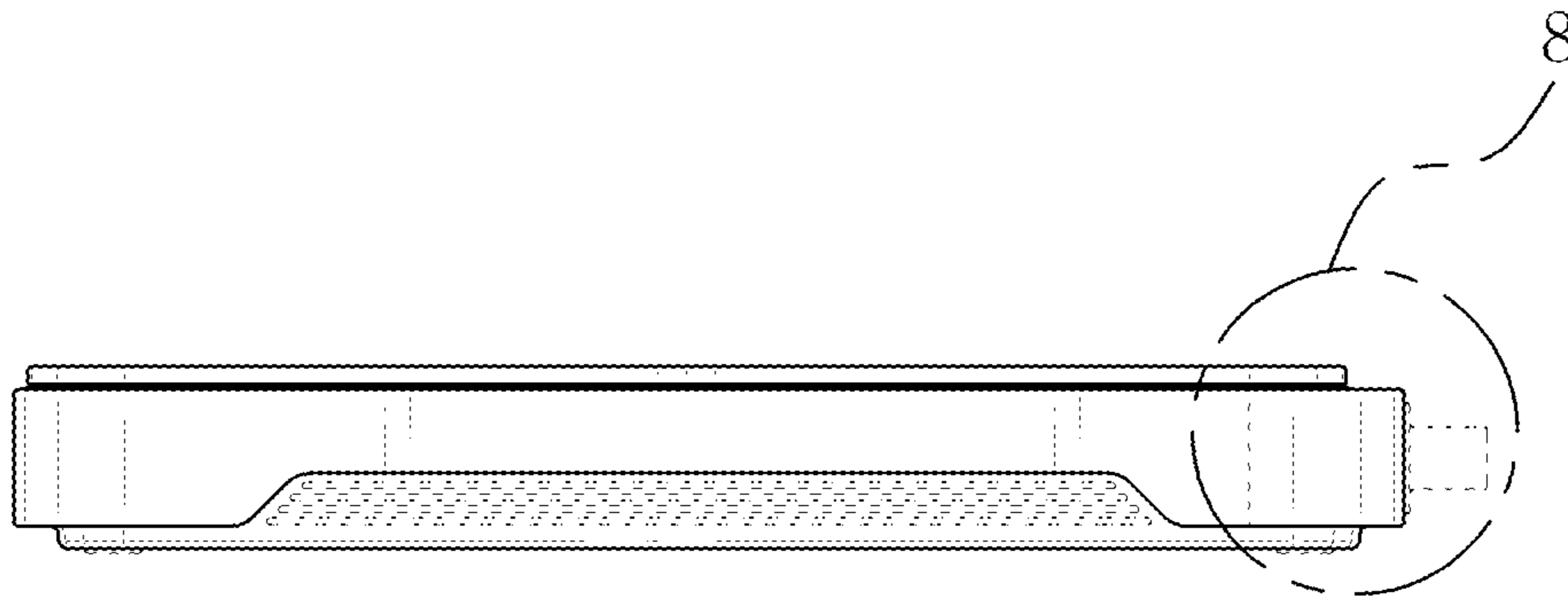

FIG. 5

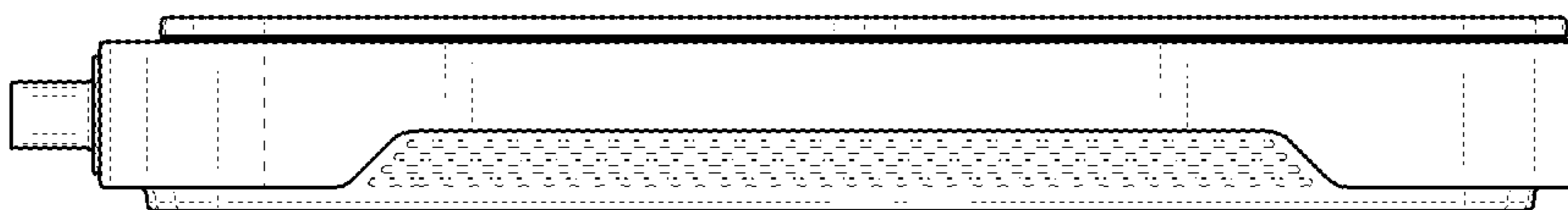

FIG. 6

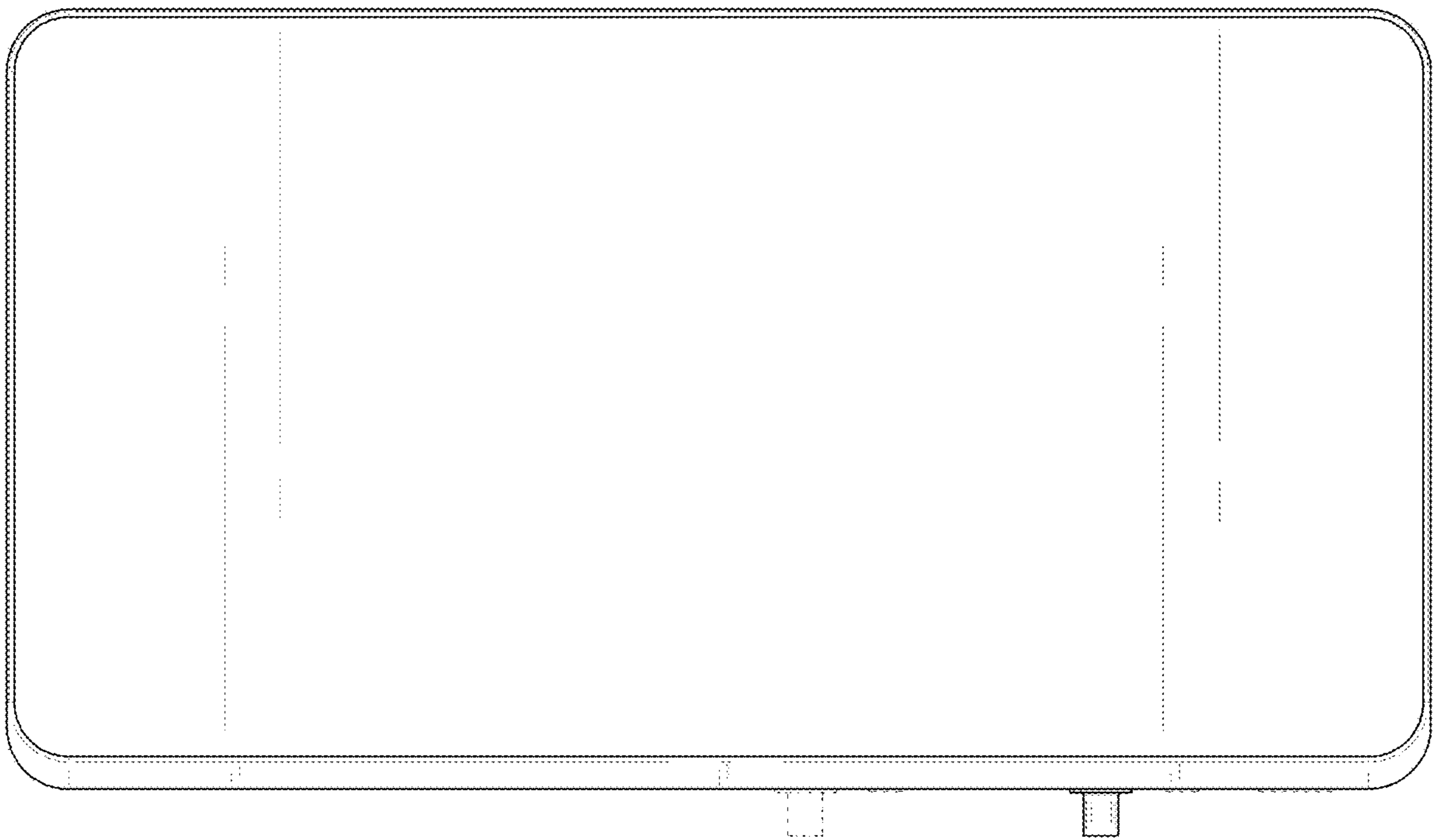

FIG. 7

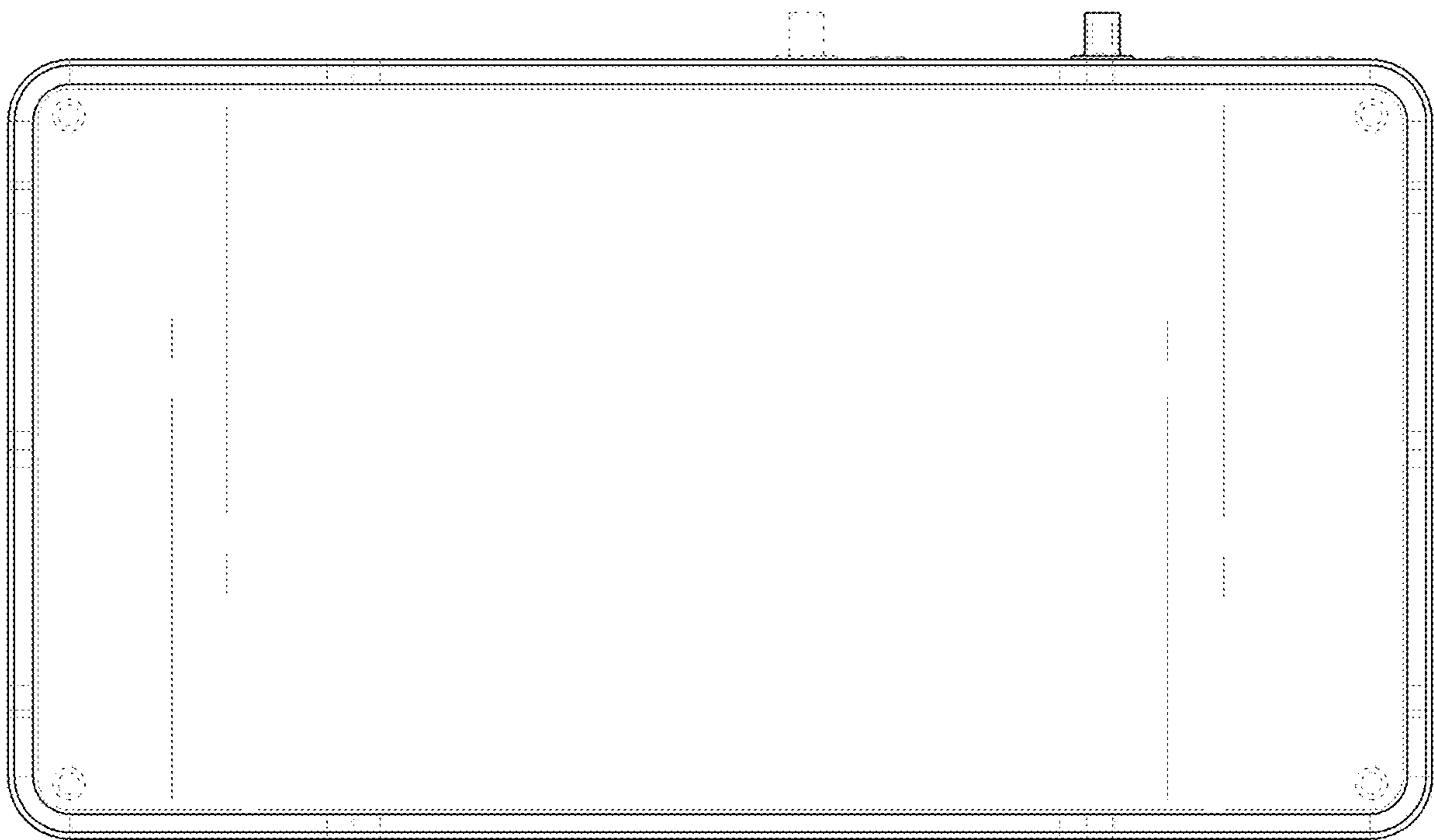

FIG. 8

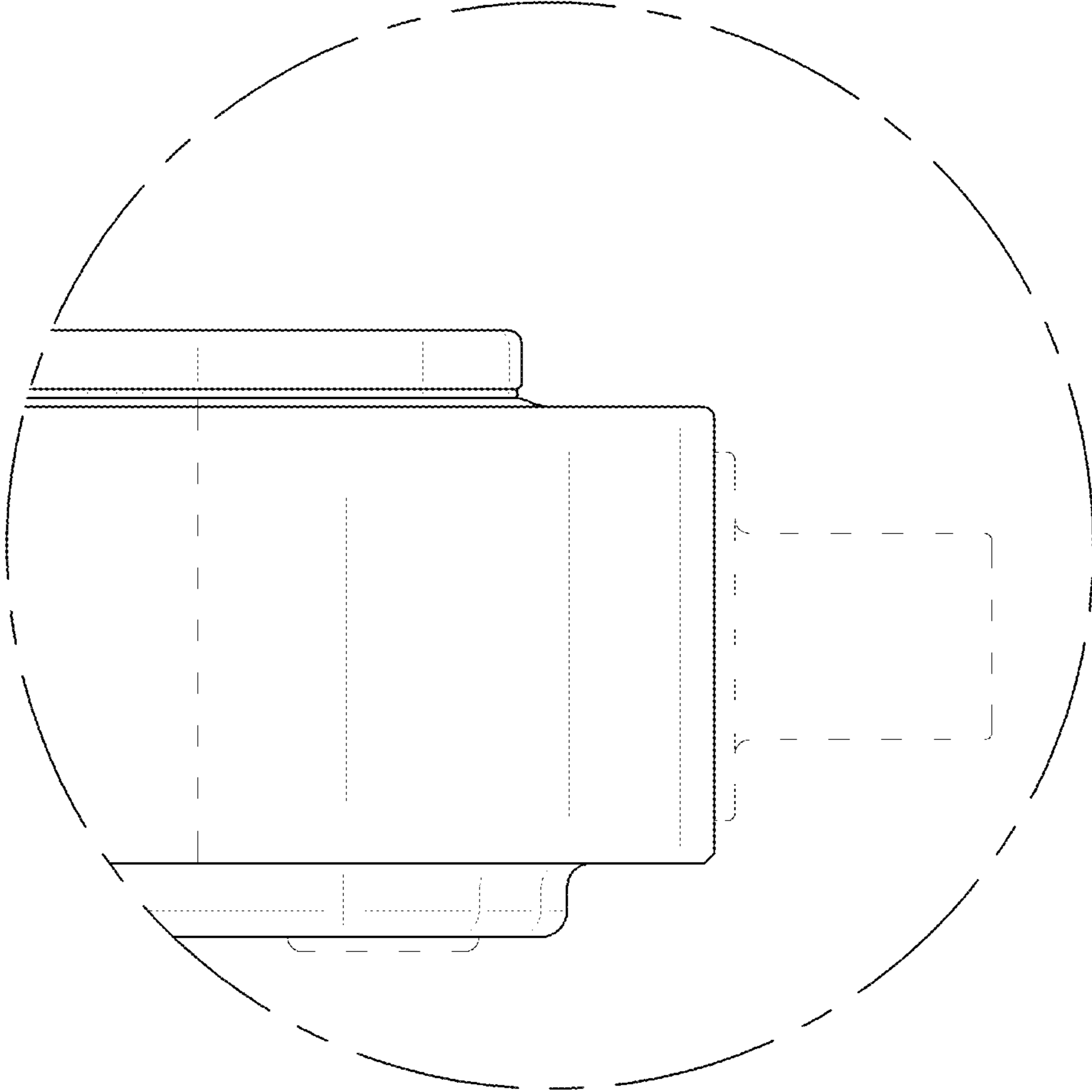



FIG. 9

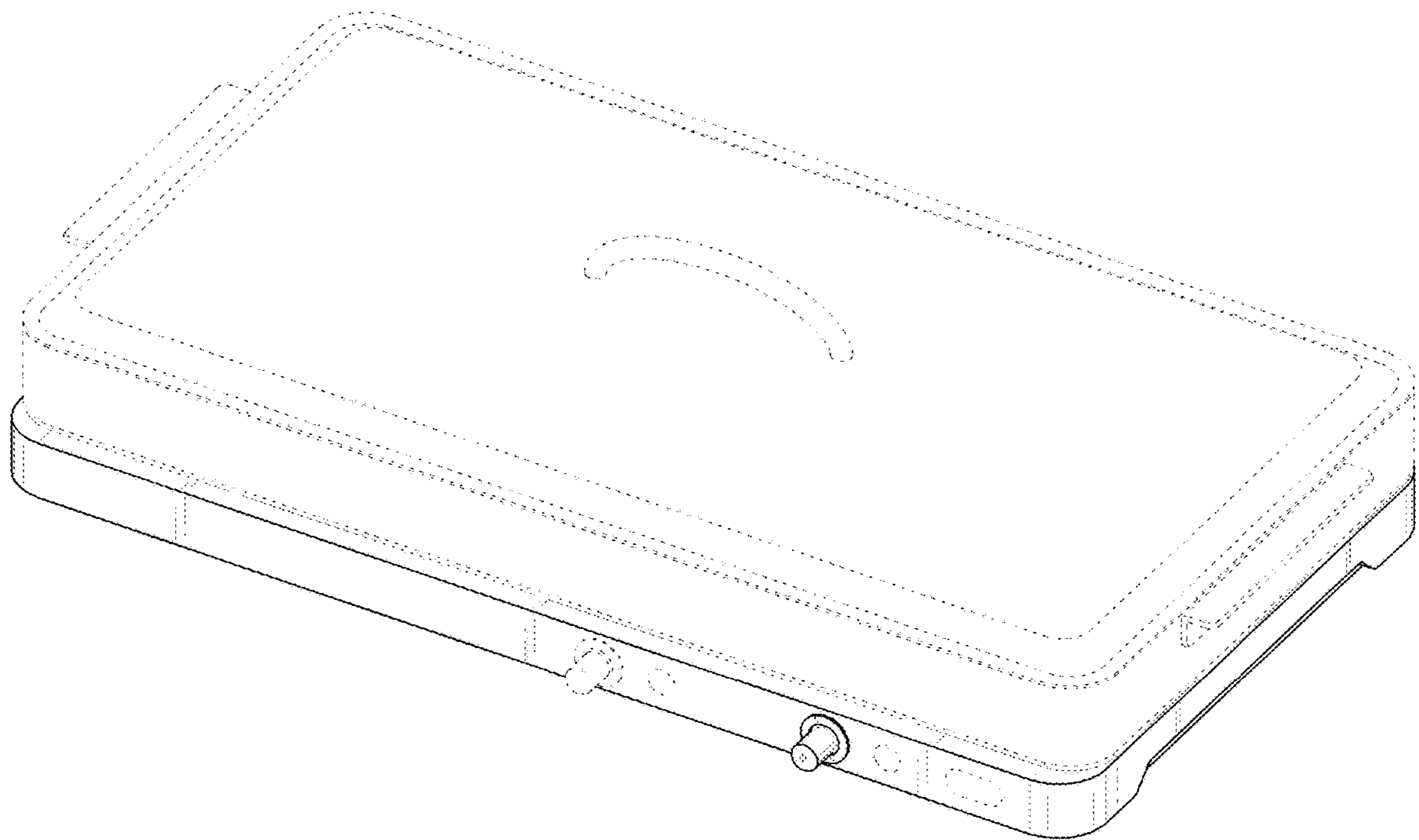

FIG. 10

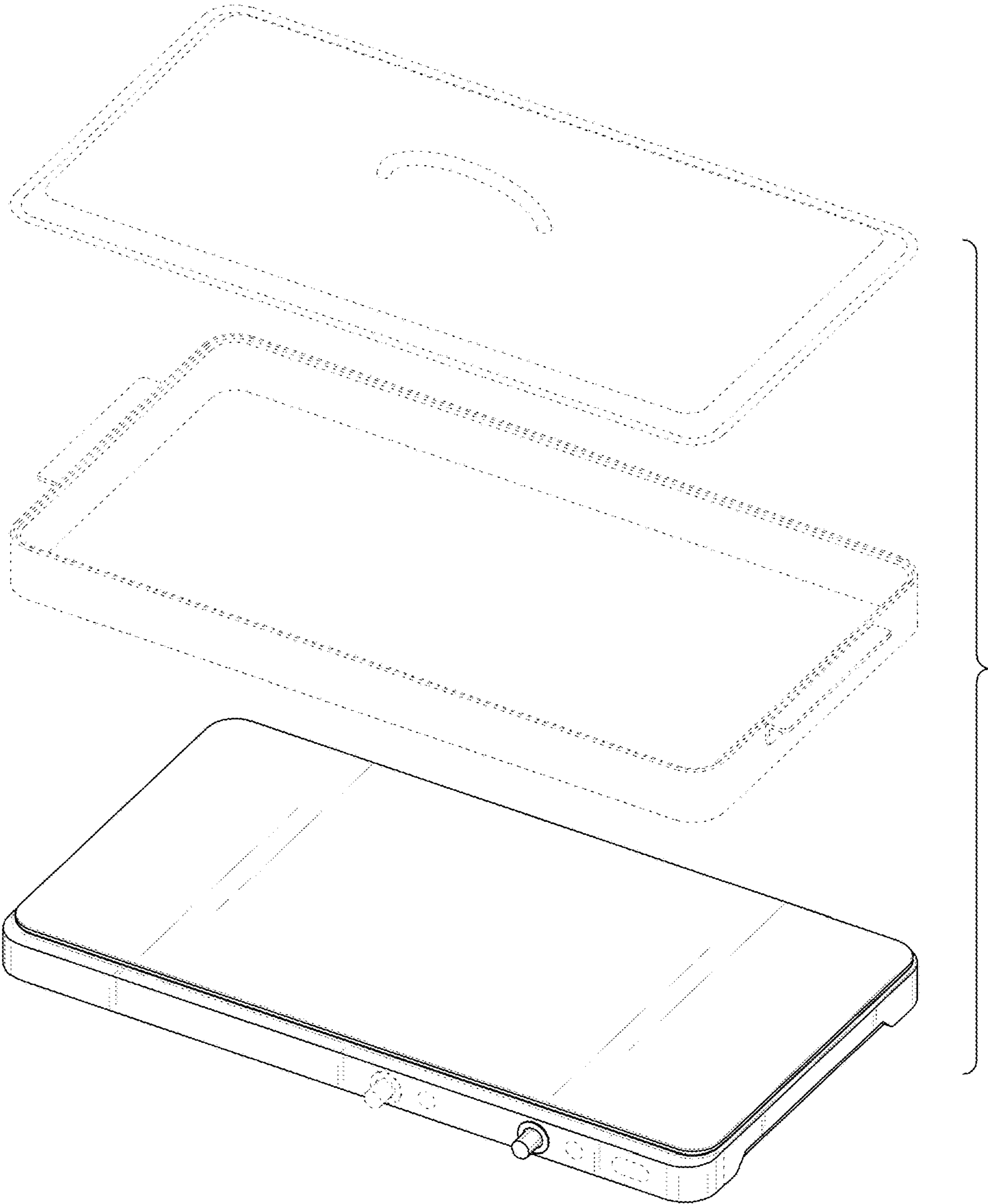

FIG. 11

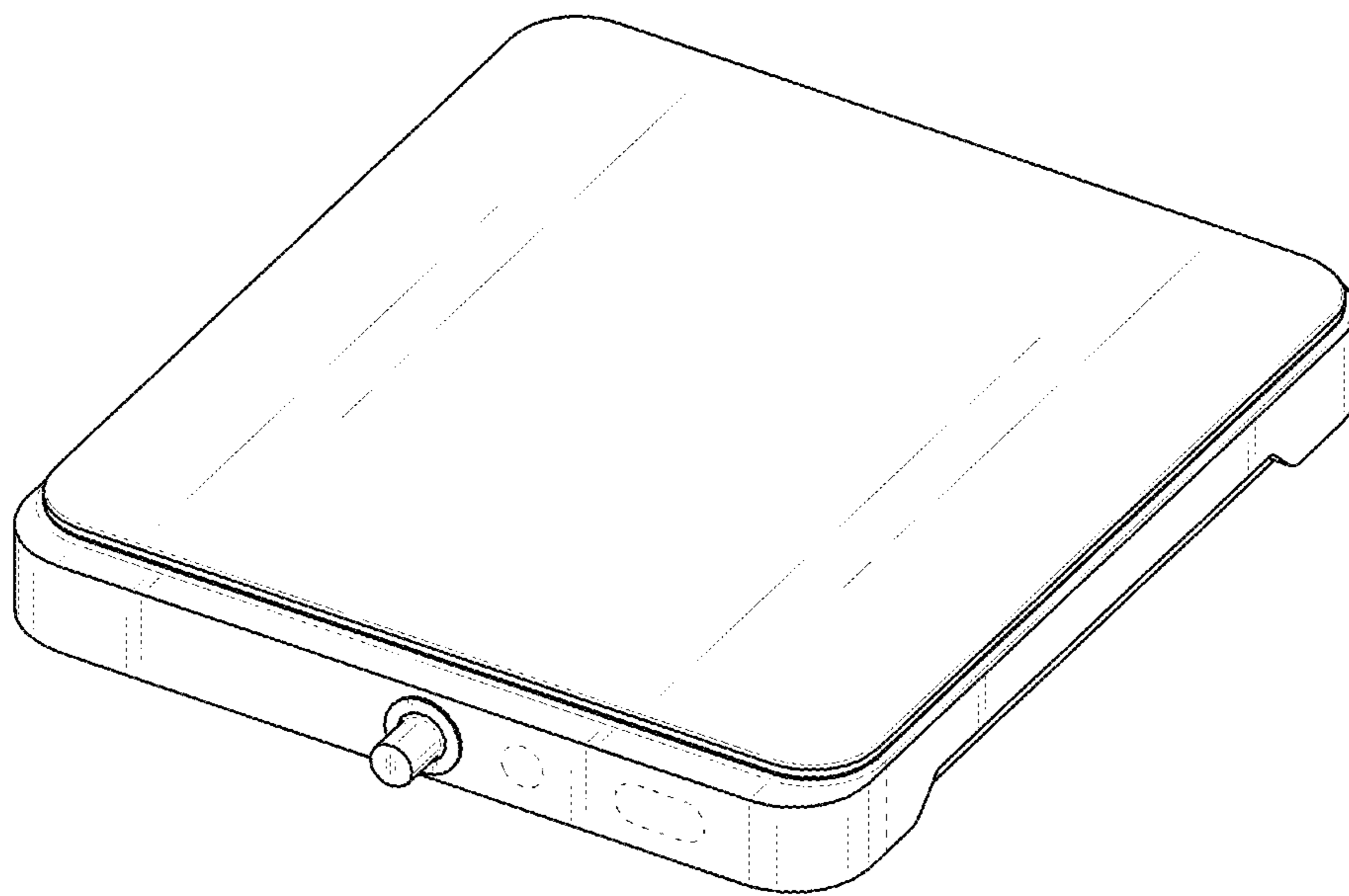

FIG. 12

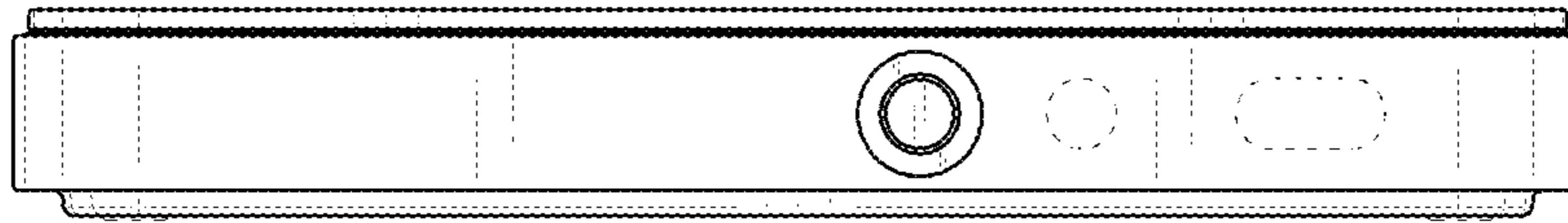

FIG. 13

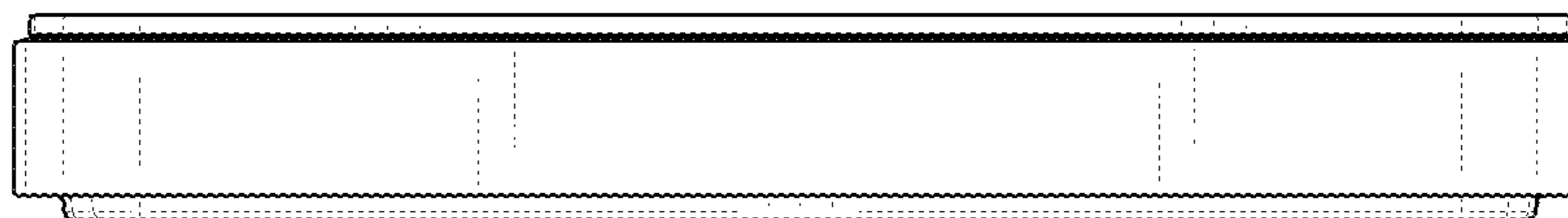

FIG. 14

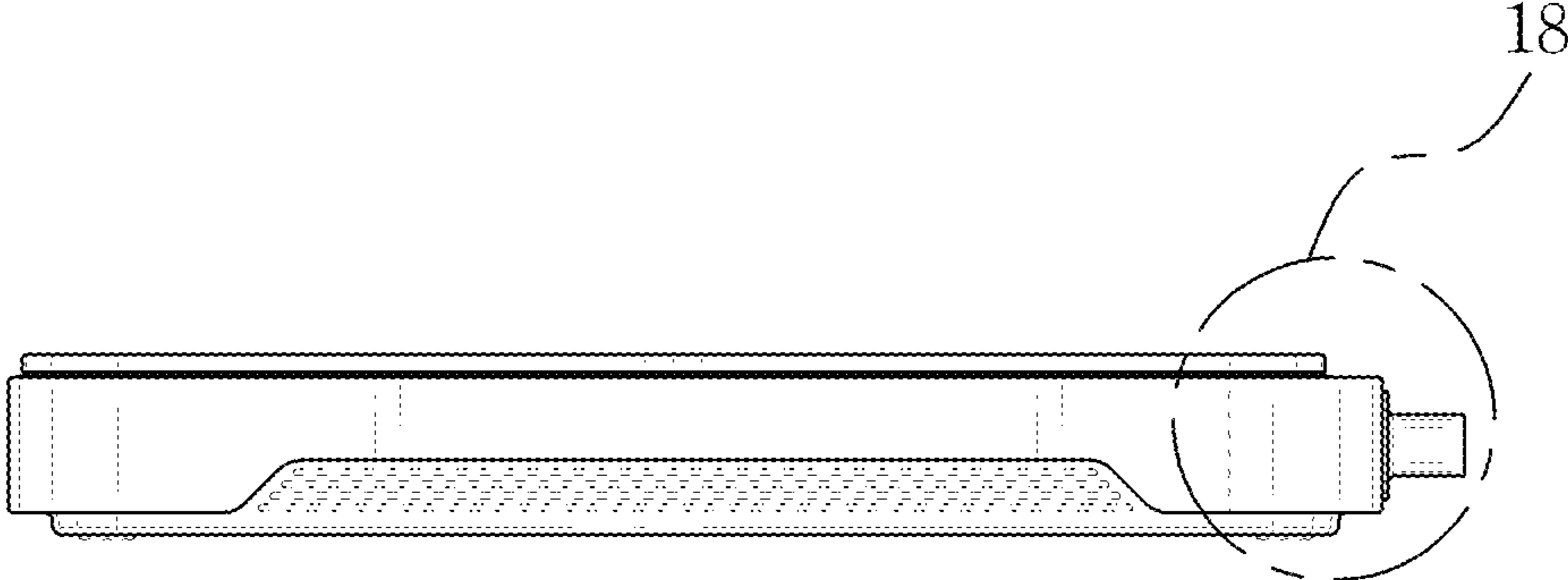

FIG. 15

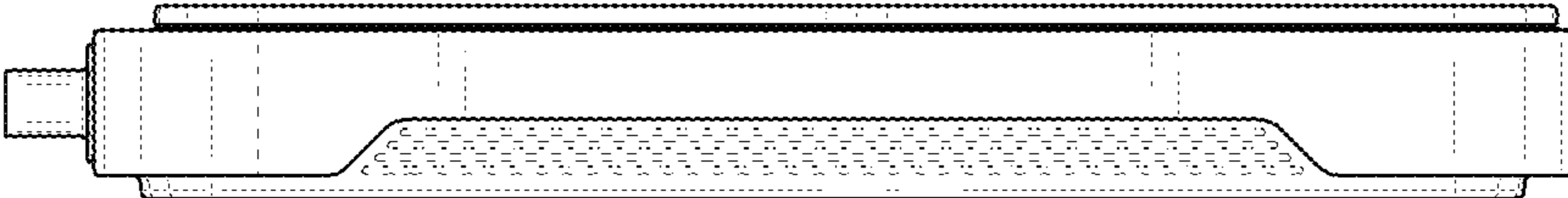

FIG. 16

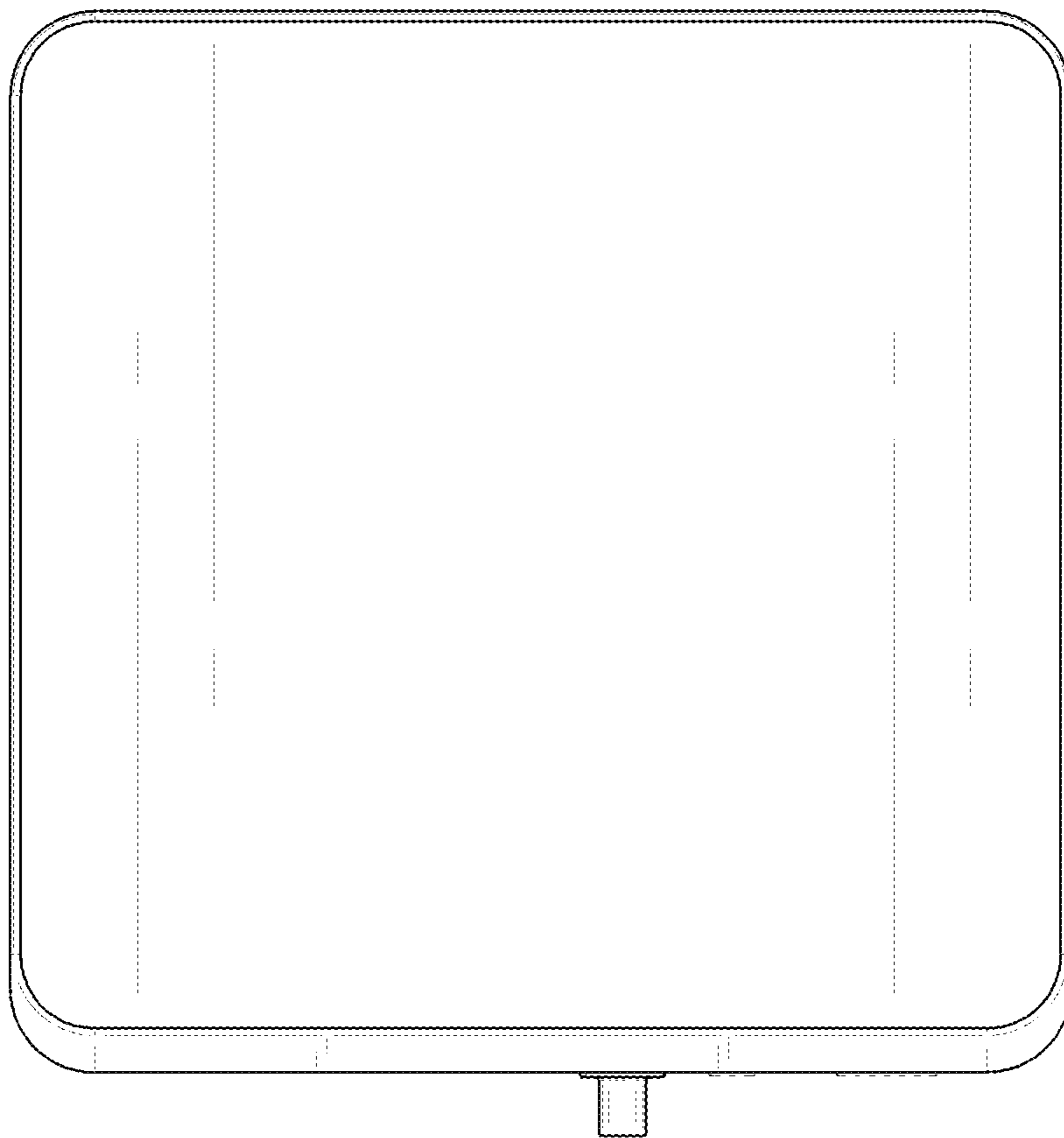

FIG. 17

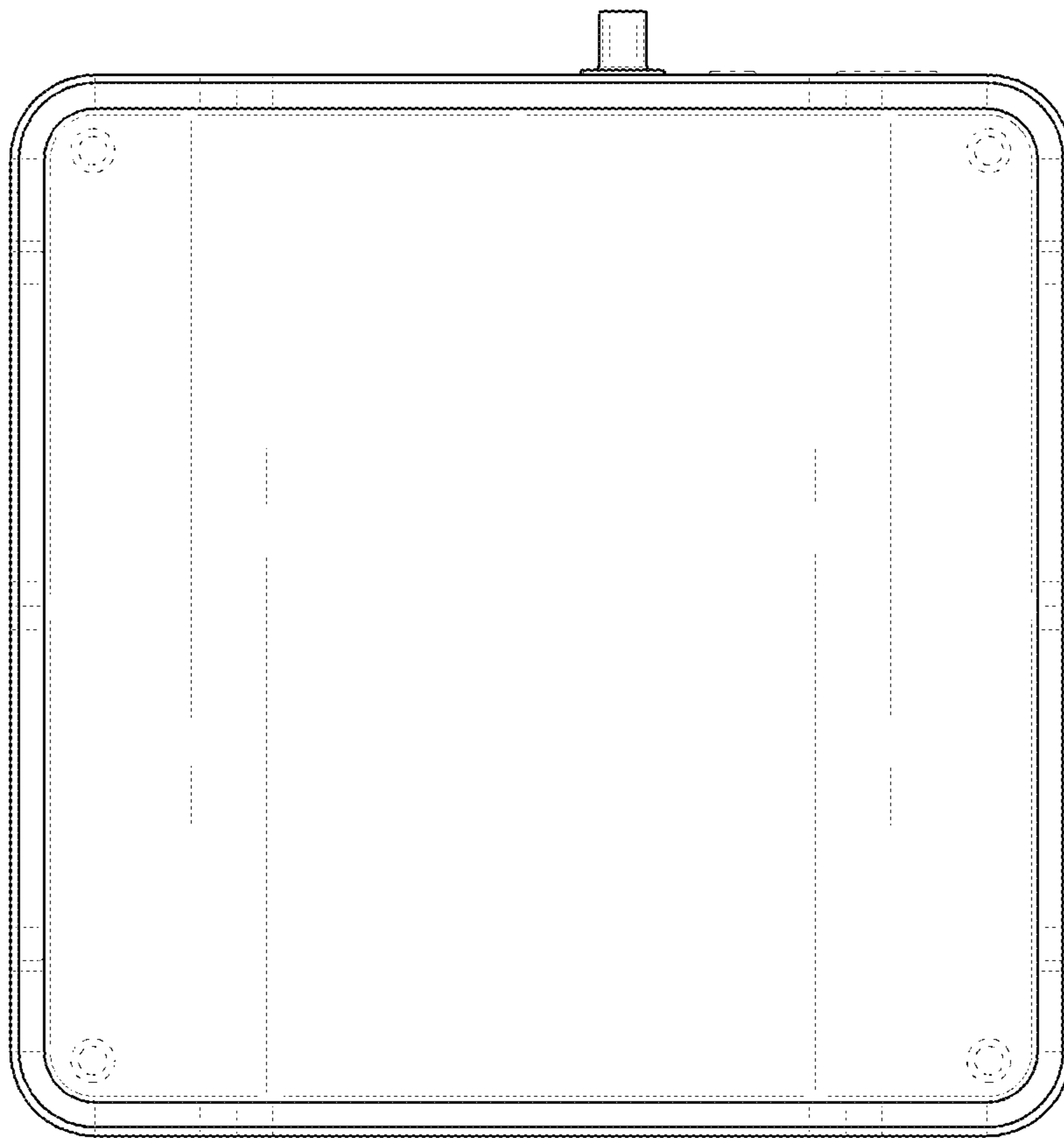

FIG. 18

