



US00D919987S

(12) **United States Design Patent**
Zhou

(10) **Patent No.:** **US D919,987 S**

(45) **Date of Patent:** **** May 25, 2021**

(54) **AIR LOUNGER**

(71) Applicant: **Xiaoou Zhou**, Zhejiang (CN)

(72) Inventor: **Xiaoou Zhou**, Zhejiang (CN)

(73) Assignee: **Wuyi Instinct Outdoor Products Co., Ltd.**, Zhejiang (CN)

(**) Term: **15 Years**

(21) Appl. No.: **29/708,546**

(22) Filed: **Oct. 8, 2019**

(51) **LOC (13) Cl.** **06-01**

(52) **U.S. Cl.**
USPC **D6/361**

(58) **Field of Classification Search**
USPC D6/334, 361, 367, 368, 369, 370, 375,
D6/377, 382, 604
CPC A47C 1/02; A47C 1/024; A47C 1/025;
A47C 1/026; A47C 1/14; A47C 1/143;
A47C 1/146; A47C 3/16; A47C 4/54
See application file for complete search history.

(56) **References Cited**

U.S. PATENT DOCUMENTS

5,033,742 A * 7/1991 Johnson A63B 21/4037
482/140
D483,088 S * 12/2003 Zheng D21/803
D486,877 S * 2/2004 Peterson D21/809

D487,129 S * 2/2004 Peterson D21/803
D829,459 S * 10/2018 Schnermann D6/361
D871,789 S * 1/2020 Zhu D6/361
D900,495 S * 11/2020 Zhou D6/361
D903,350 S * 12/2020 Zhou D6/361
D903,351 S * 12/2020 Zhou D6/361
D904,056 S * 12/2020 Schnermann D6/361
2013/0111661 A1 * 5/2013 Furuland A47D 9/005
5/93.1
2018/0317657 A1 * 11/2018 Yang A47C 3/16

FOREIGN PATENT DOCUMENTS

GB 599618 A * 3/1948 A47C 4/54

* cited by examiner

Primary Examiner — R. Johnson

(57) **CLAIM**

The ornamental design for an air lounger, as shown and described.

DESCRIPTION

FIG. 1 is a perspective view of an air lounger showing my new design;
FIG. 2 is a front elevational view thereof;
FIG. 3 is a rear elevational view thereof;
FIG. 4 is a left side elevational view thereof;
FIG. 5 is a right side elevational view thereof;
FIG. 6 is a top plan view thereof; and,
FIG. 7 is a bottom plan view thereof.

1 Claim, 7 Drawing Sheets

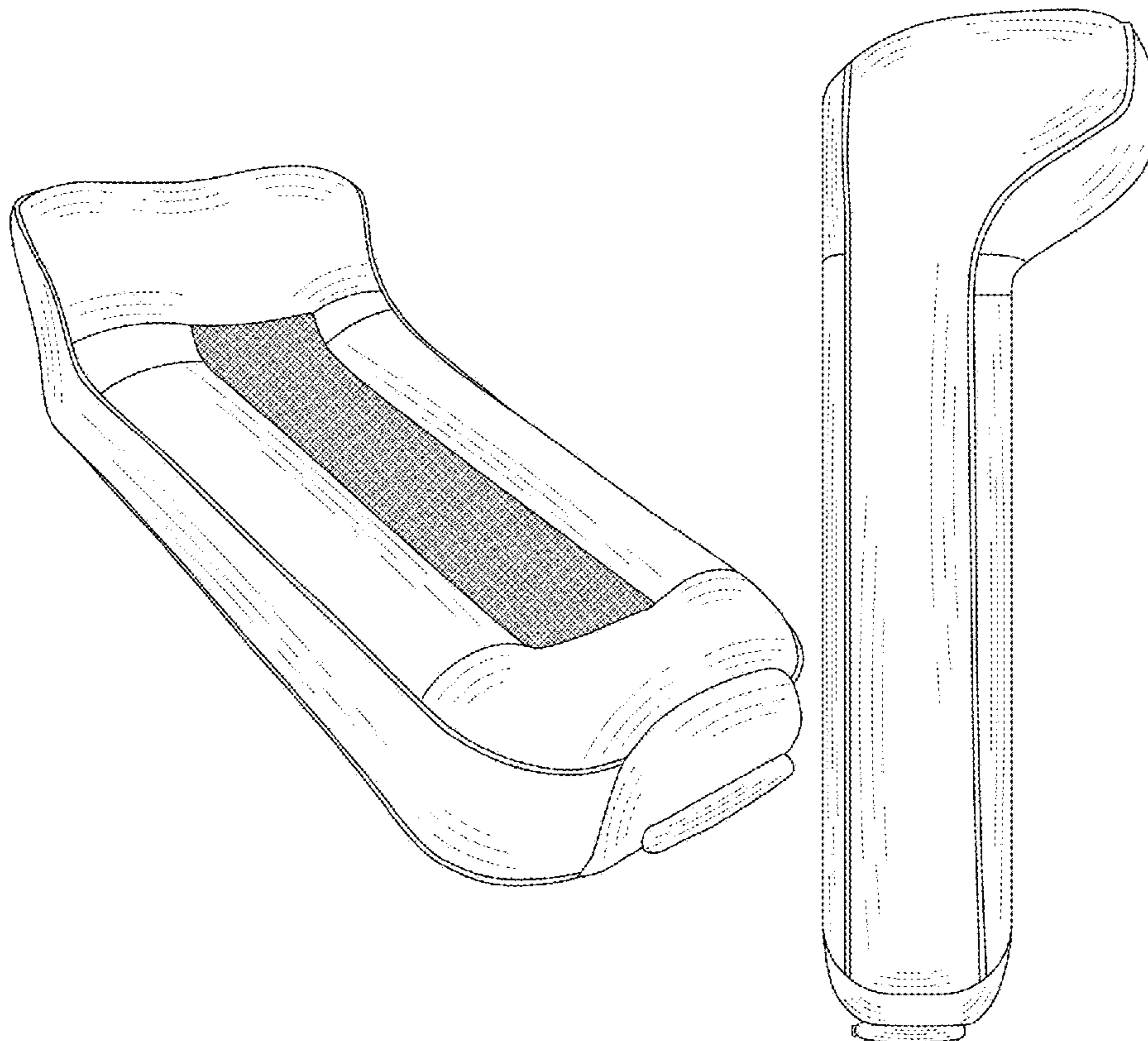

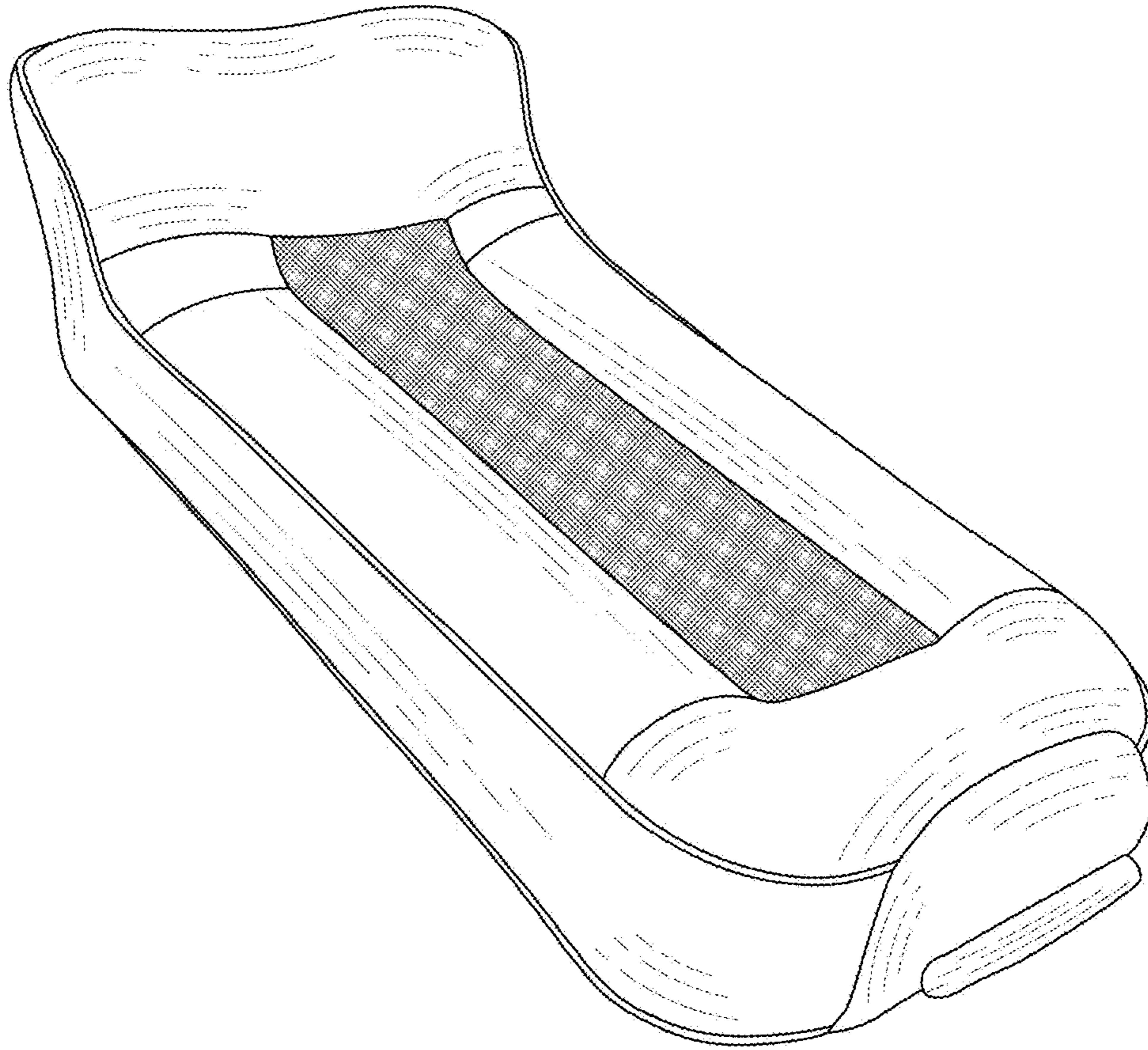

FIG. 1

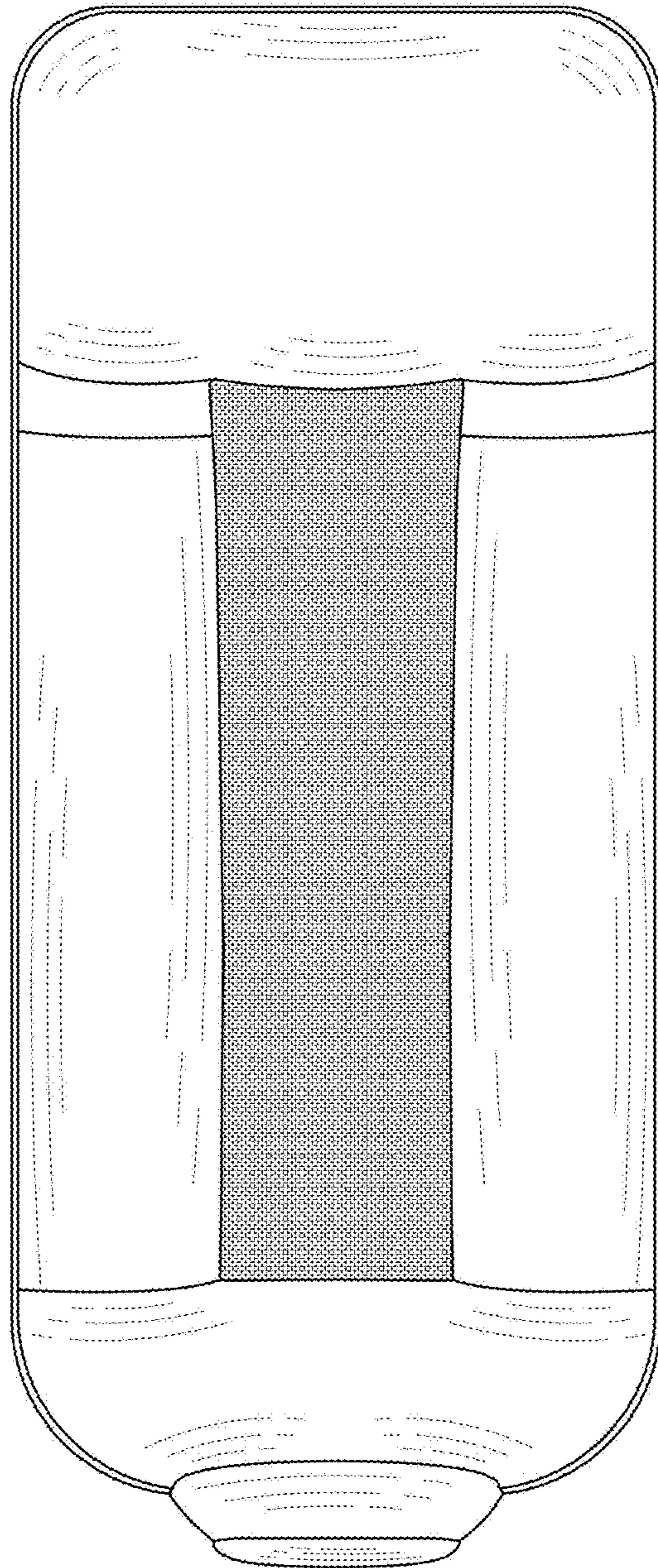

FIG. 2

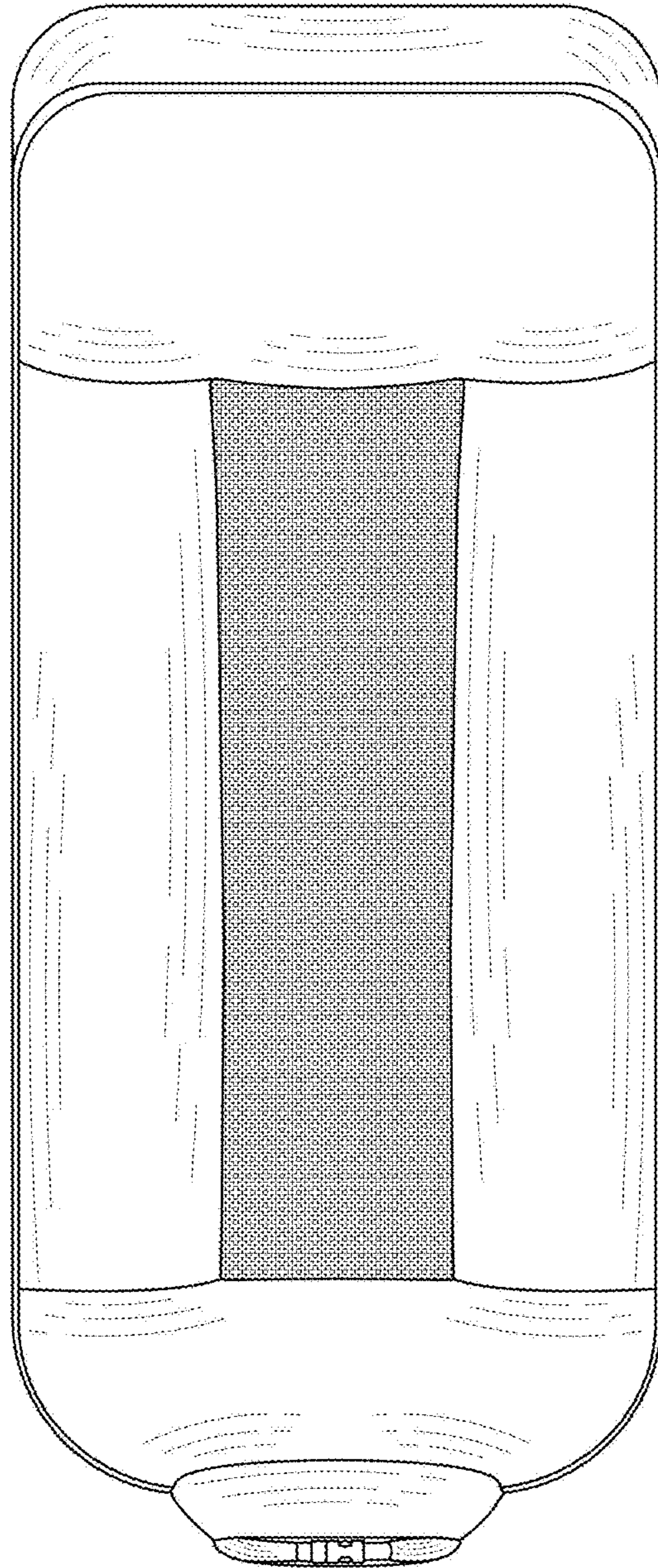

FIG. 3

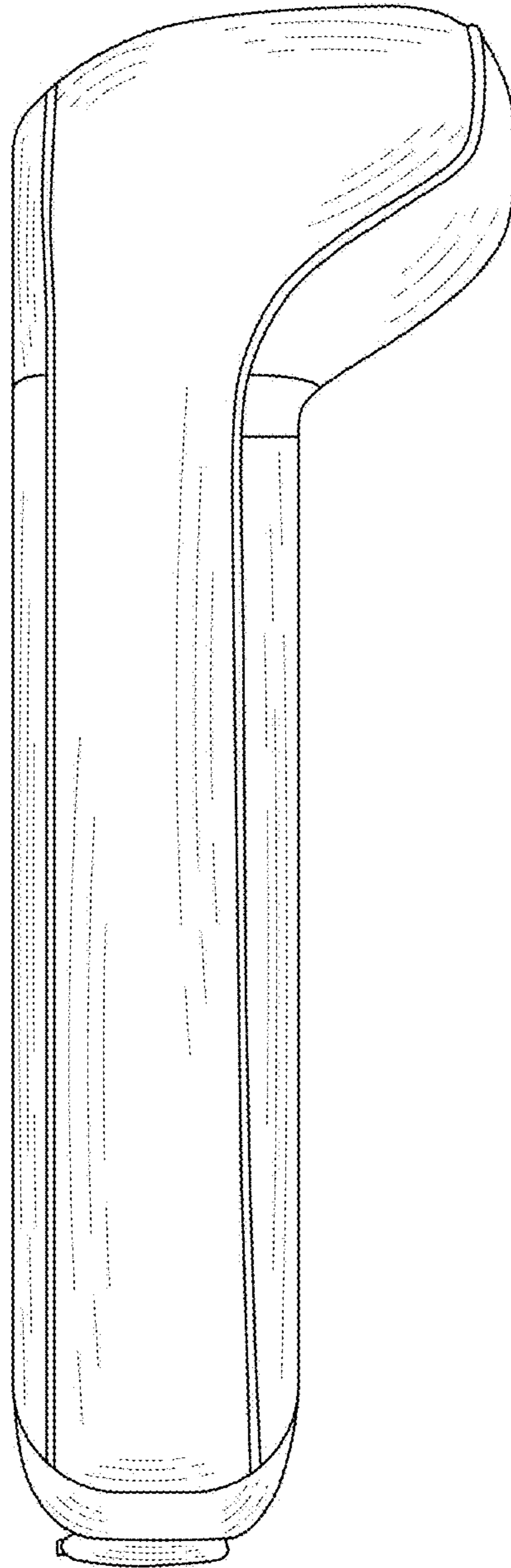

FIG. 4

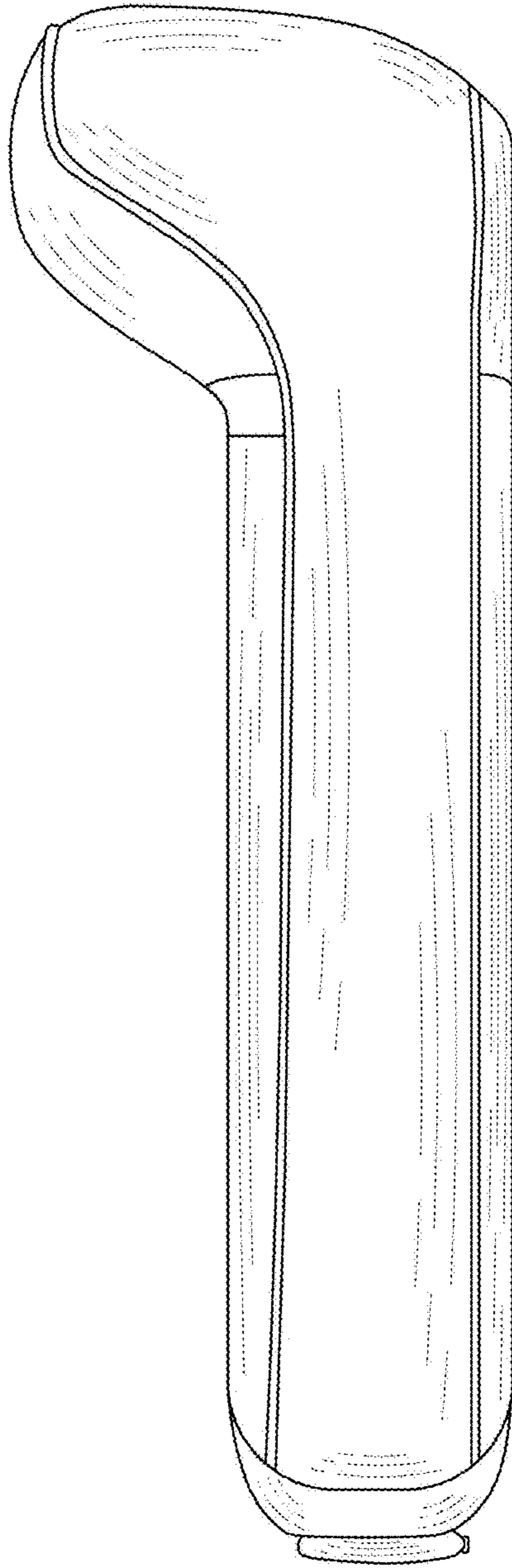

FIG. 5

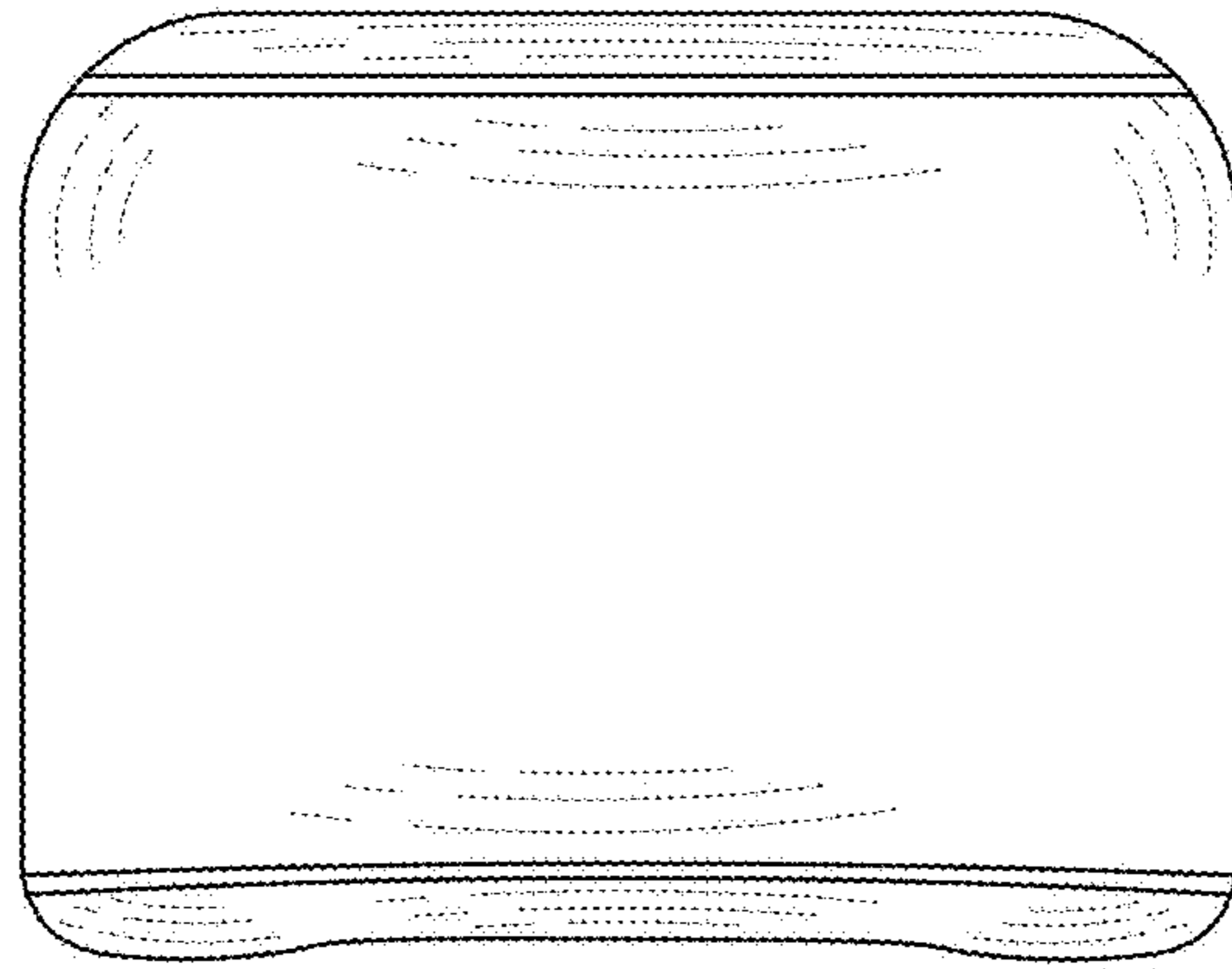

FIG. 6

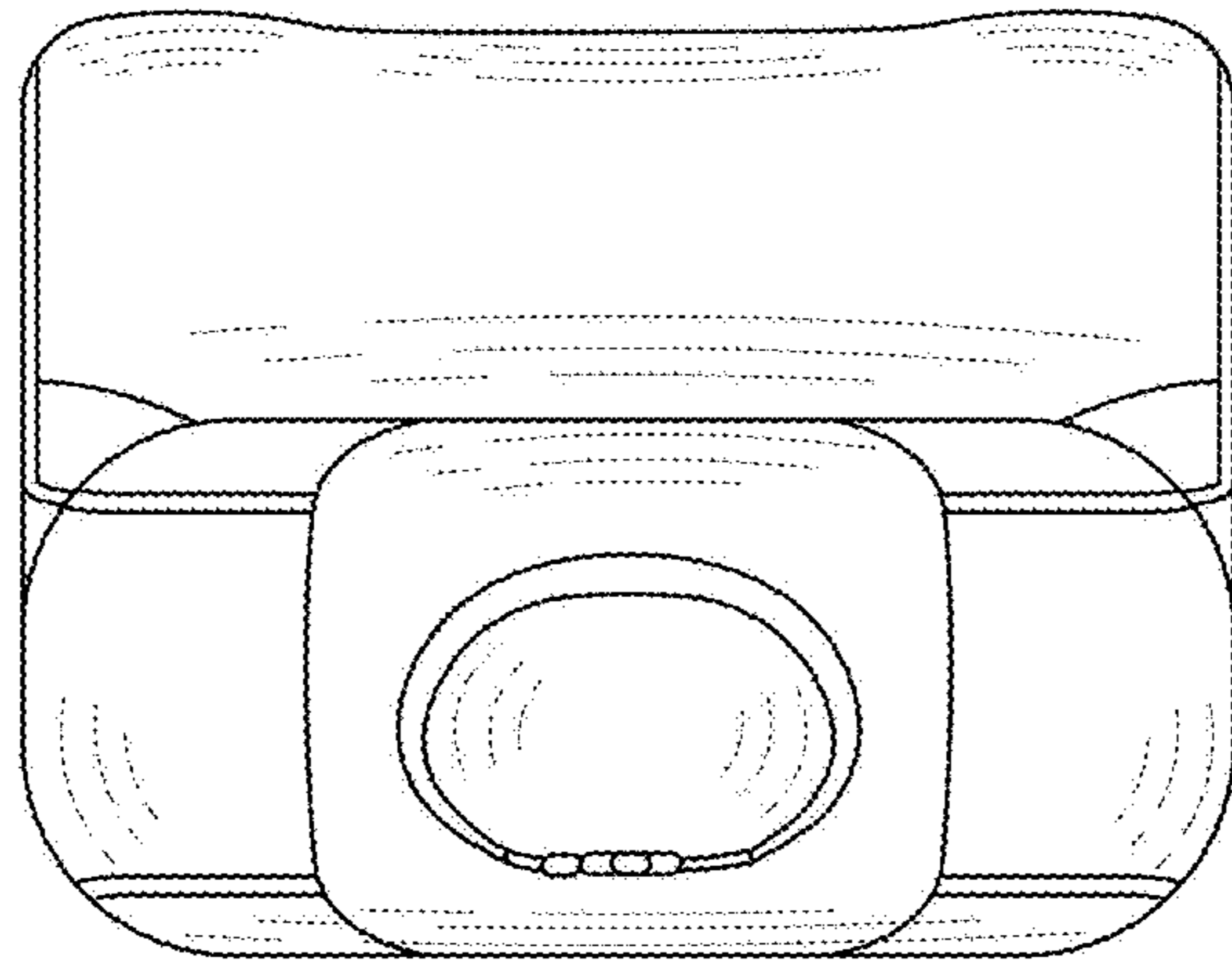

FIG. 7