



US00D919975S

(12) **United States Design Patent** (10) **Patent No.:** **US D919,975 S**
Amat (45) **Date of Patent:** **** *May 25, 2021**

(54) **FASHION ORNAMENT**
(71) Applicant: **J. Choo Limited**, London (GB)
(72) Inventor: **Lina Amat**, London (GB)
(73) Assignee: **J. Choo Limited**, London (GB)
(*) Notice: This patent is subject to a terminal disclaimer.
(**) Term: **15 Years**
(21) Appl. No.: **29/706,729**
(22) Filed: **Sep. 23, 2019**
(30) **Foreign Application Priority Data**
Apr. 10, 2019 (EM) 006374807-0002
(51) **LOC (13) Cl.** **03-01**
(52) **U.S. Cl.**
USPC **D3/324; D11/40; D11/43**
(58) **Field of Classification Search**
USPC D3/232-233, 240-243, 245-246, 318,
D3/322; D11/40, 43
CPC .. A45C 1/024; A45C 3/06; A45C 3/08; A45C
13/02; A45C 13/08; A45C 13/26
See application file for complete search history.

D780,445 S * 3/2017 Blahnik D3/240
D781,053 S * 3/2017 Blahnik D3/240
D858,341 S * 9/2019 Chen D11/40

* cited by examiner

Primary Examiner — Rhea Shields
(74) *Attorney, Agent, or Firm* — Fross Zelnick Lehrman & Zissu, P.C.; Lawrence E. Apolzon, Esq.

(57) **CLAIM**

The ornamental design for a fashion ornament, as shown and described.

DESCRIPTION

FIG. 1 is a front perspective view of a fashion ornament showing my new design;
FIG. 2 is a front view thereof;
FIG. 3 is a left side view thereof;
FIG. 4 is a right side view thereof;
FIG. 5 is a top view thereof;
FIG. 6 is a bottom view thereof;
FIG. 7 is a front view of the fashion ornament shown in FIG. 1, shown in the environment of a handbag;
FIG. 8 is a front perspective view of an alternative embodiment of the fashion ornament shown in FIG. 1;
FIG. 9 is a front view thereof;
FIG. 10 is a left side view thereof;
FIG. 11 is a right side view thereof;
FIG. 12 is a top view thereof;
FIG. 13 is a bottom view thereof; and,
FIG. 14 is a front view of the fashion ornament shown in FIG. 8, shown in the environment of a handbag.
In the drawings, the broken lines are for the purpose of showing portions of the fashion ornament that form no part of the claimed design.

(56) **References Cited**

U.S. PATENT DOCUMENTS

D530,076 S 10/2006 Choi
D532,596 S 11/2006 Choi
D580,648 S 11/2008 Choi
D780,443 S * 3/2017 Blahnik D3/240
D780,444 S * 3/2017 Blahnik D3/240

1 Claim, 10 Drawing Sheets

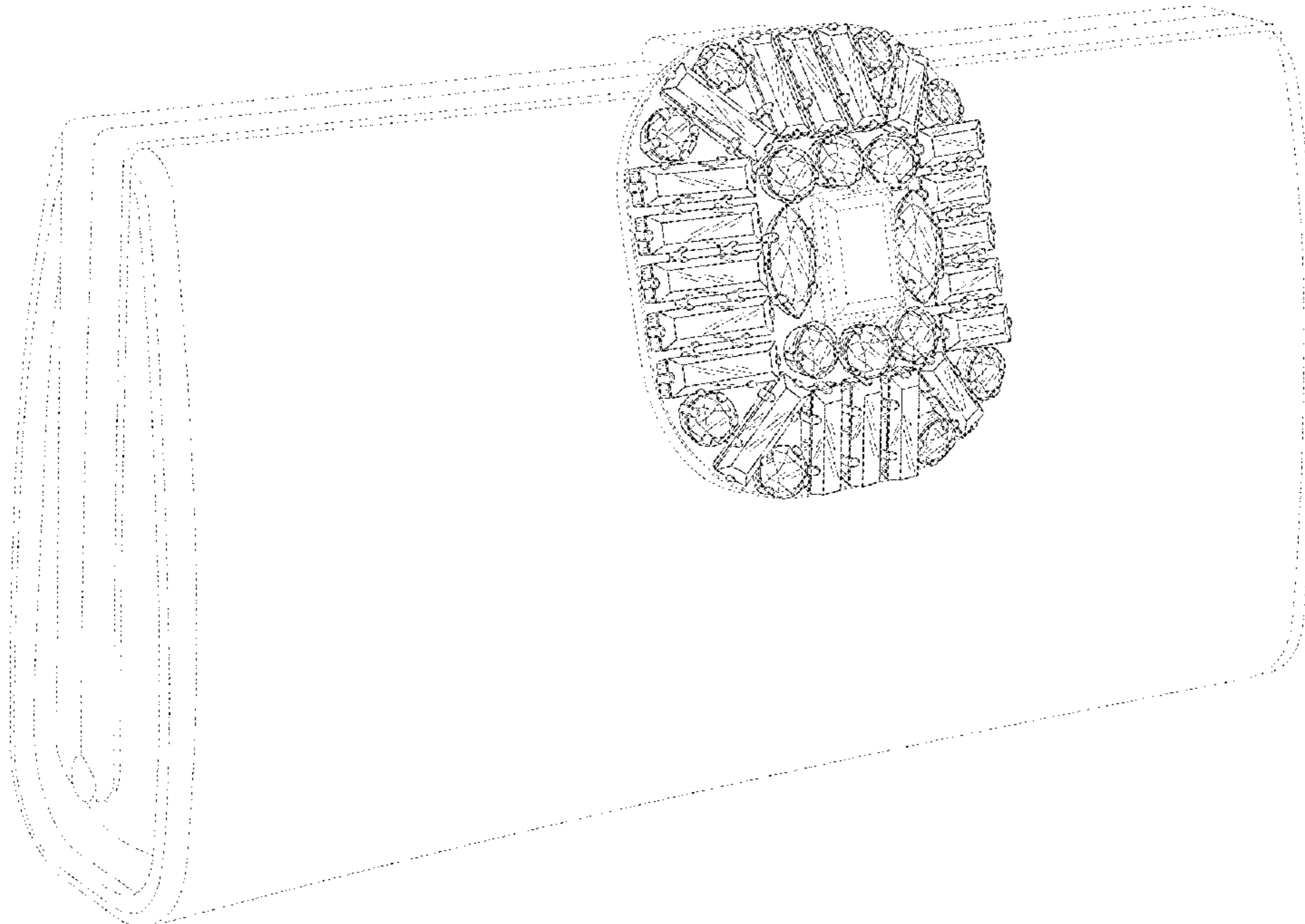

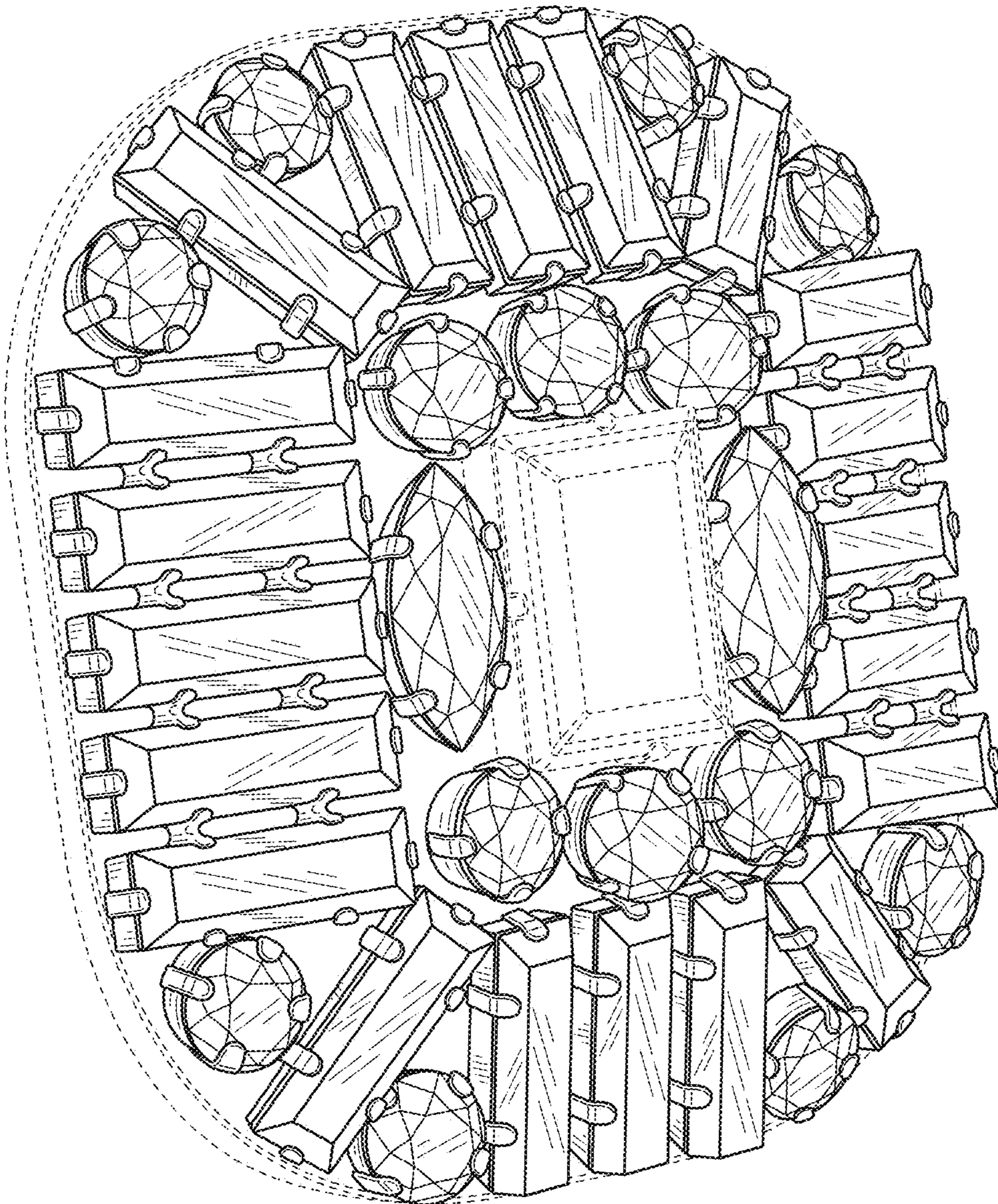

FIG. 1

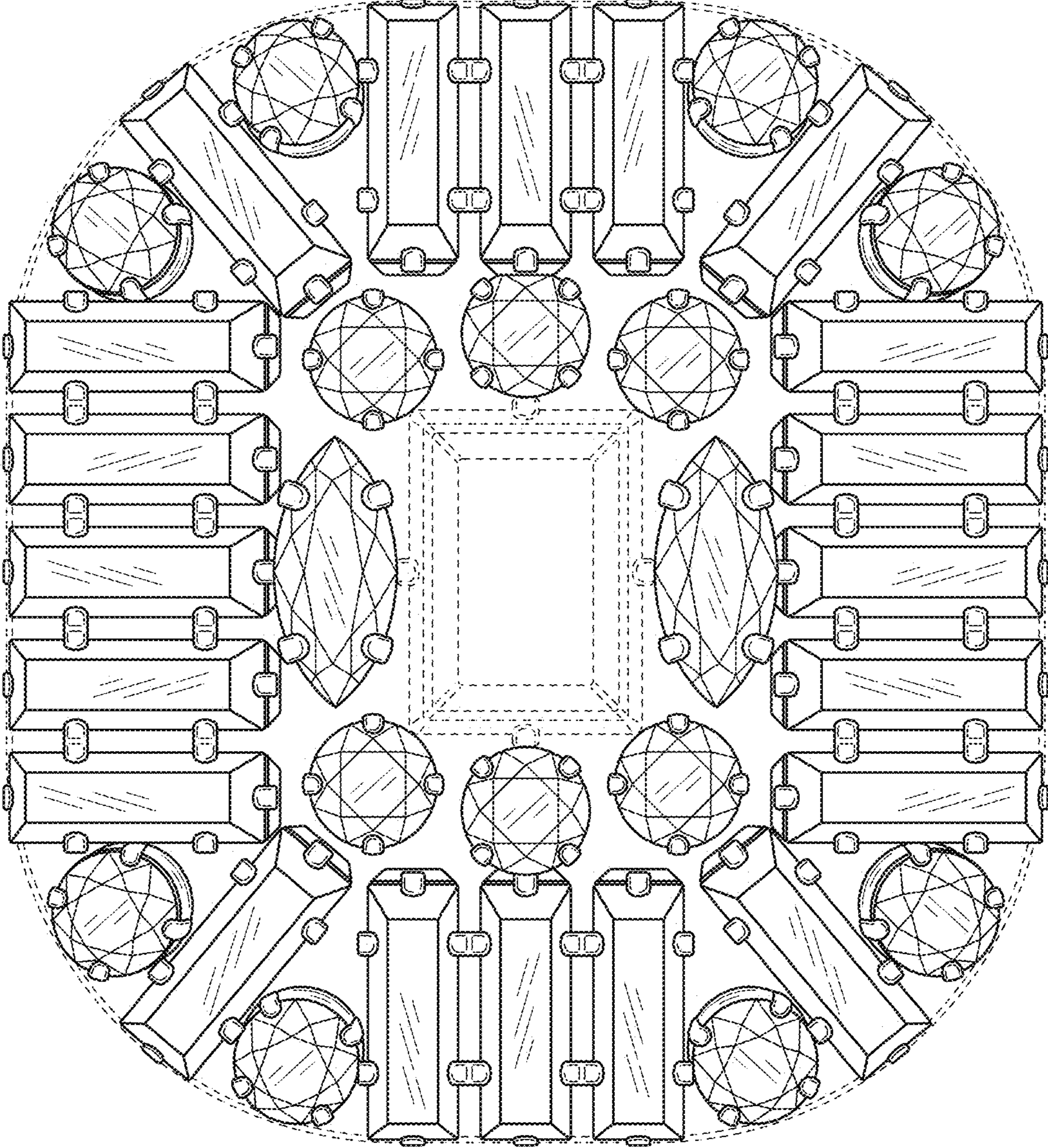

FIG. 2

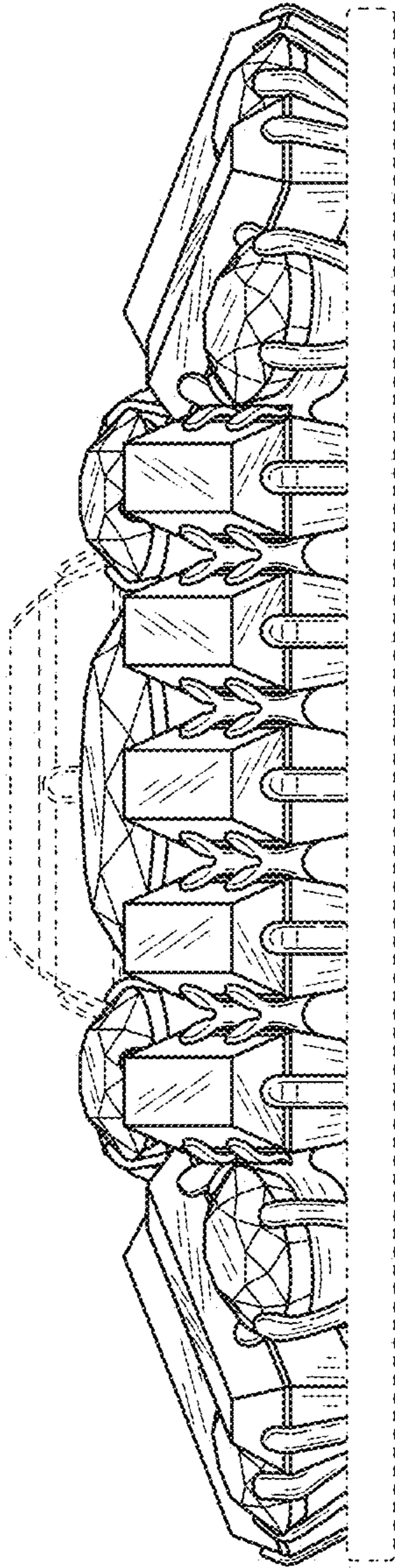

FIG. 3

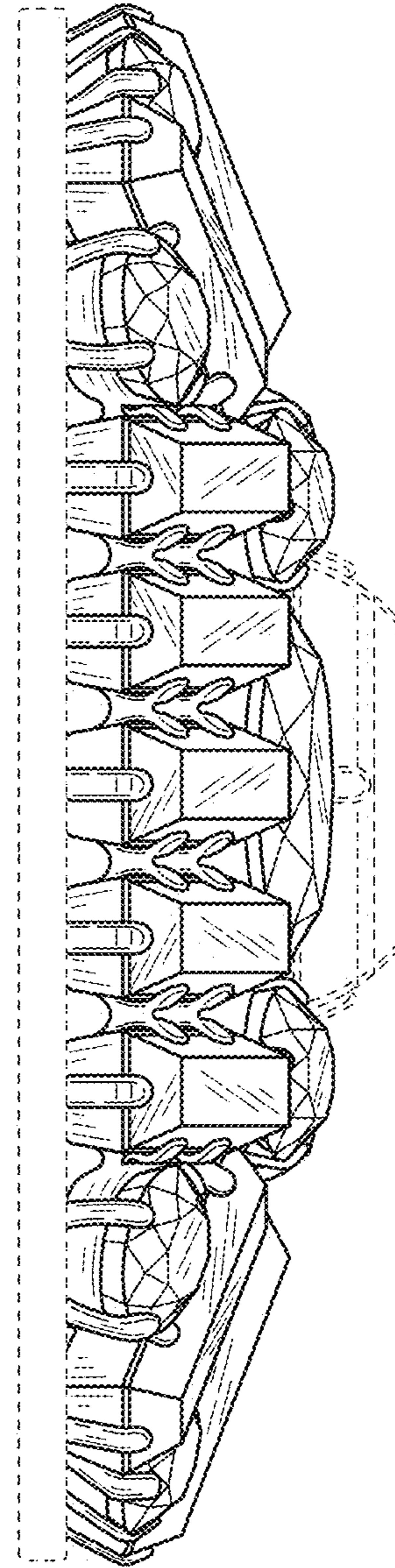

FIG. 4

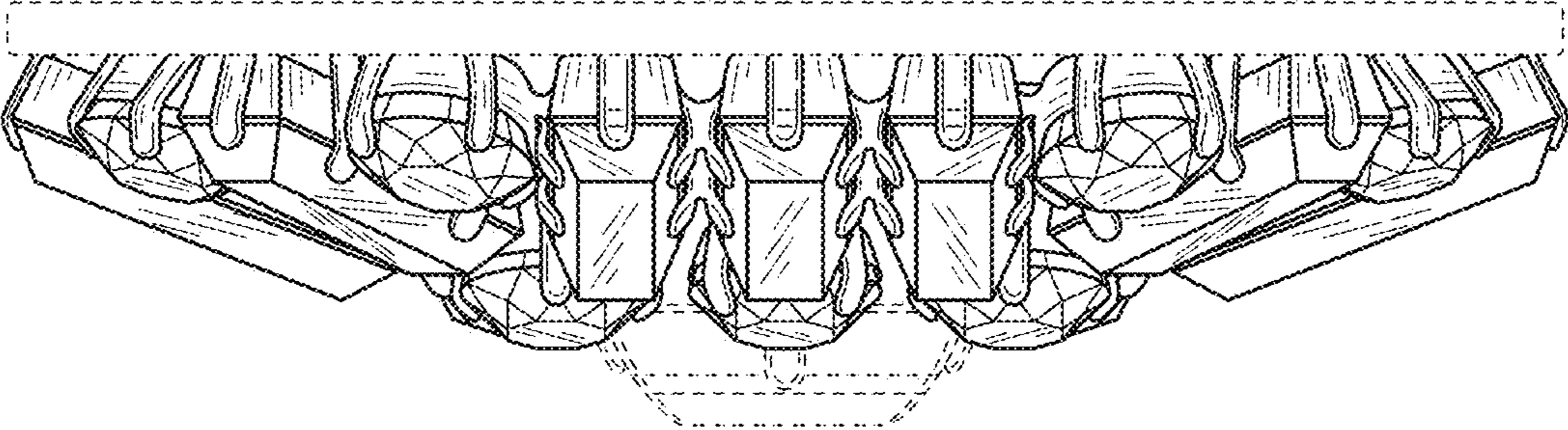

FIG. 5

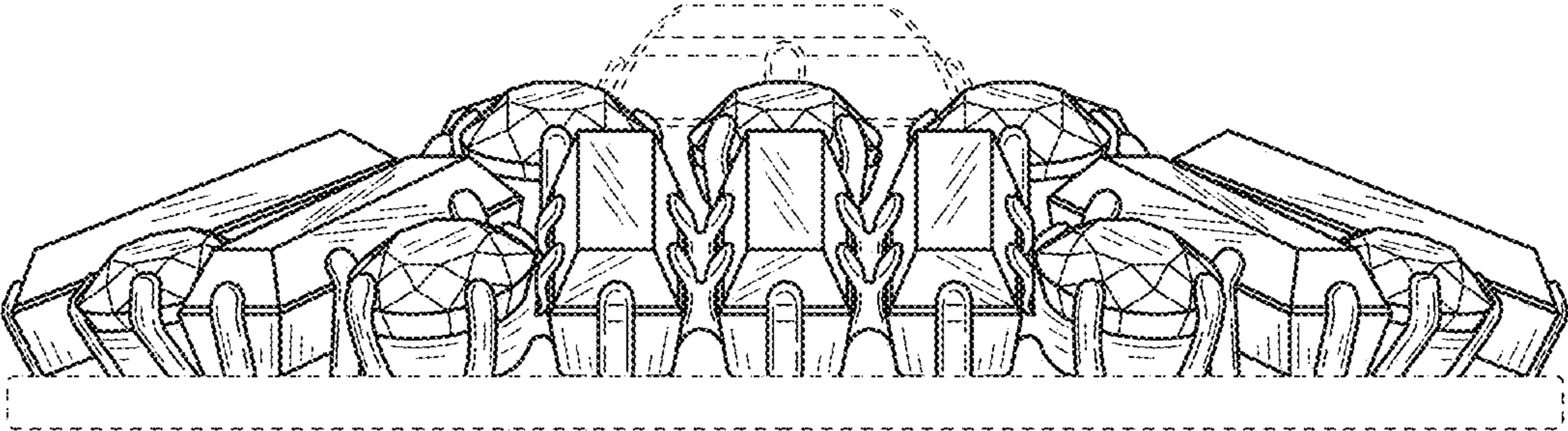

FIG. 6

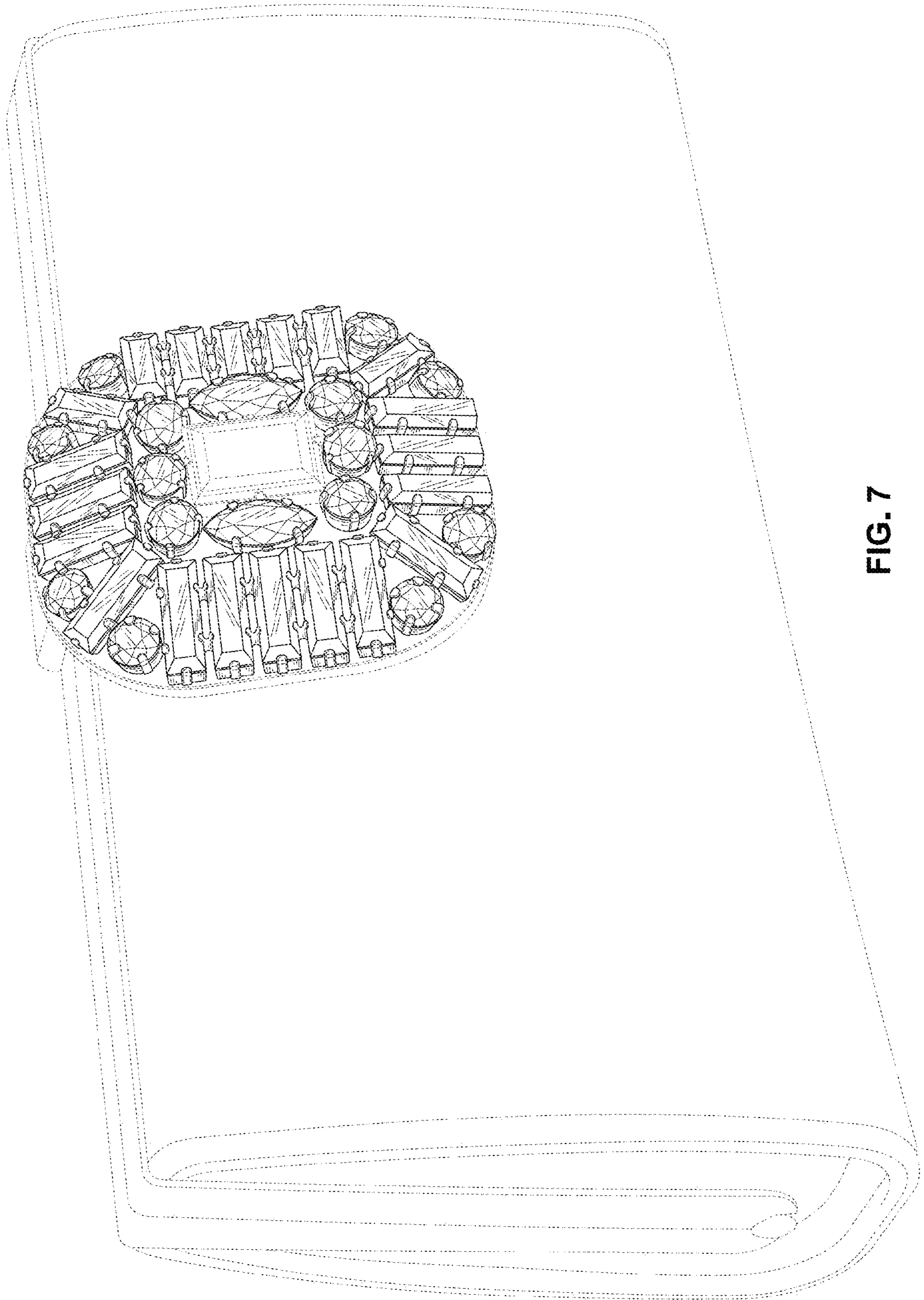

FIG. 7

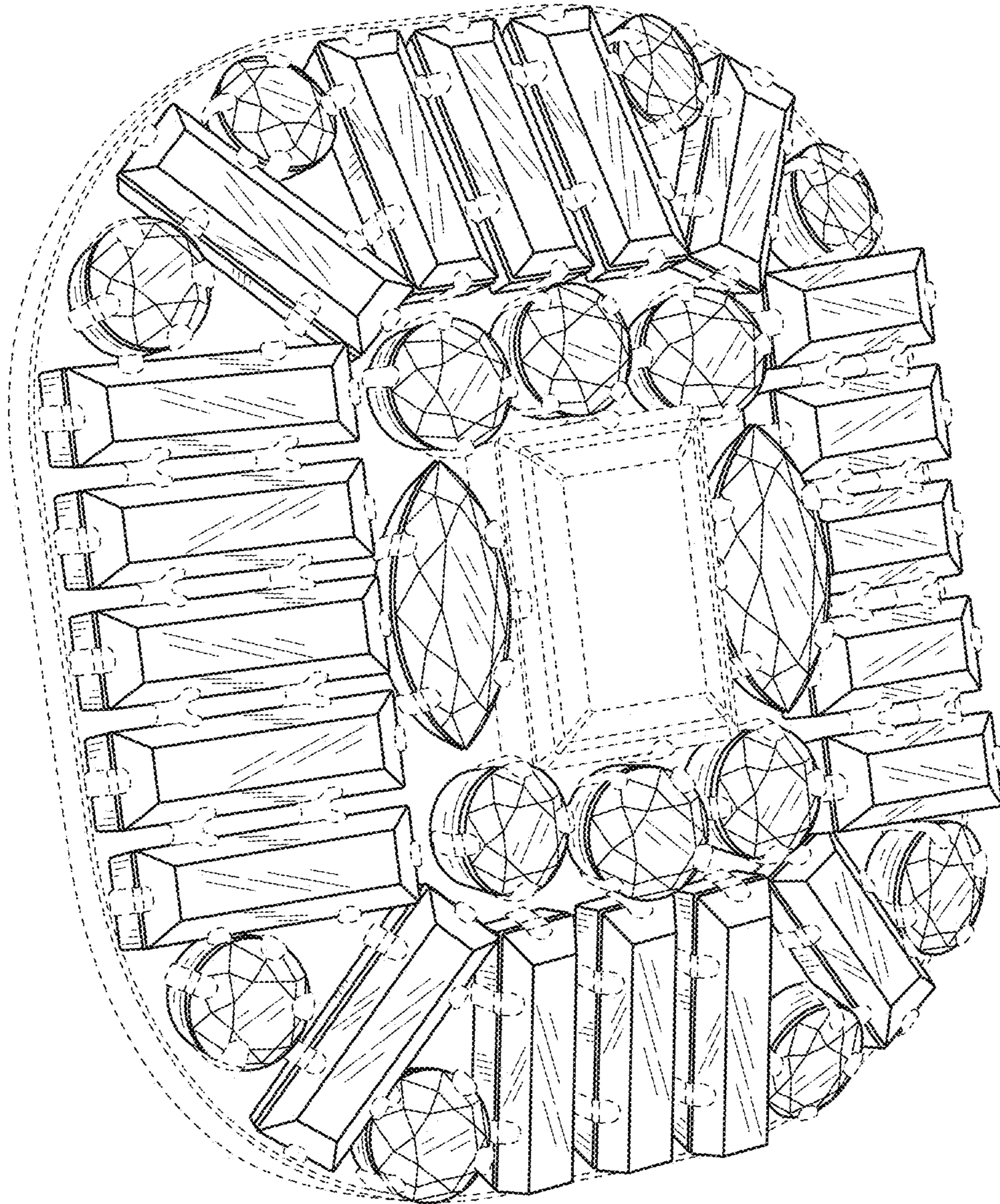

FIG. 8

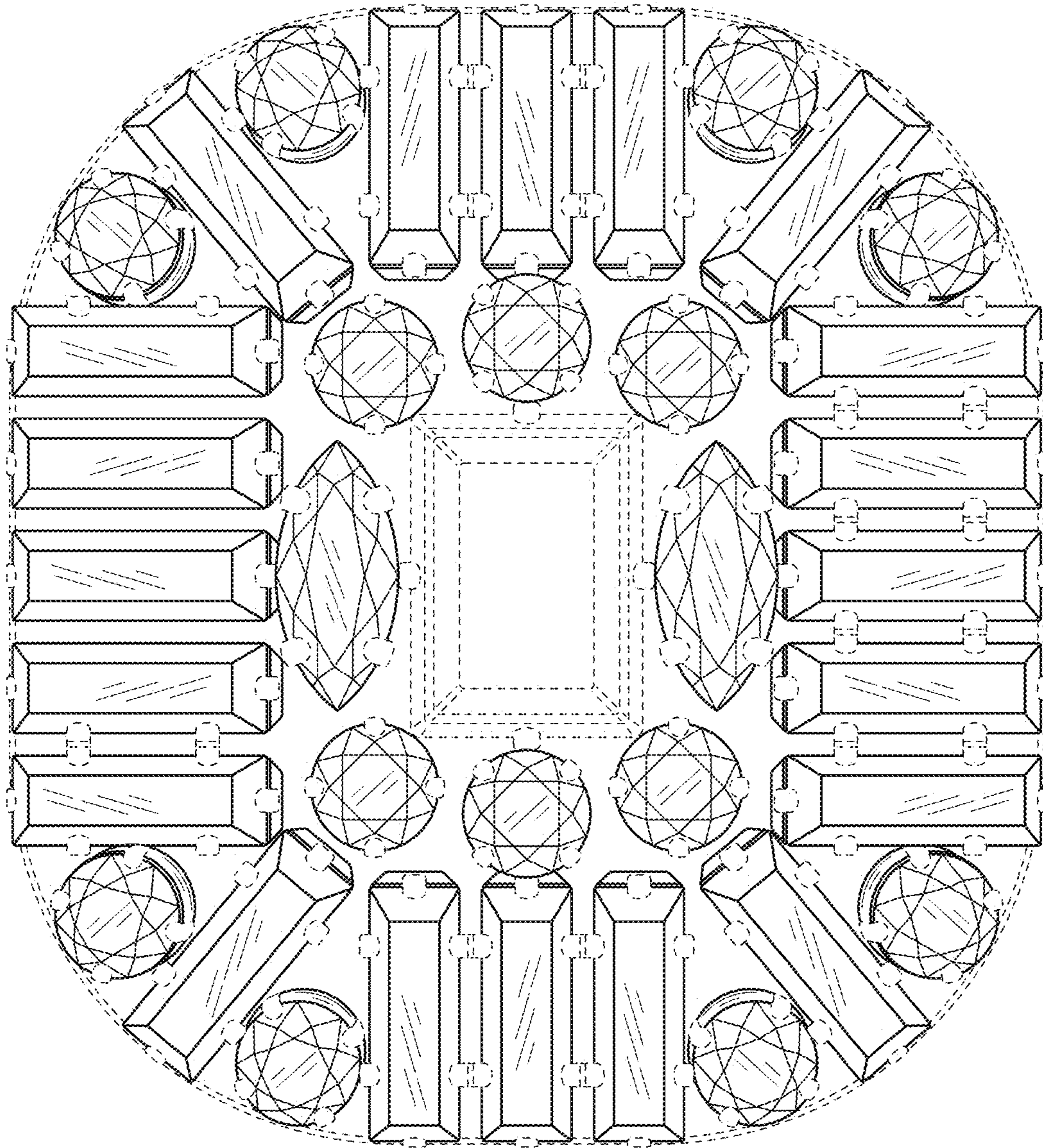

FIG. 9

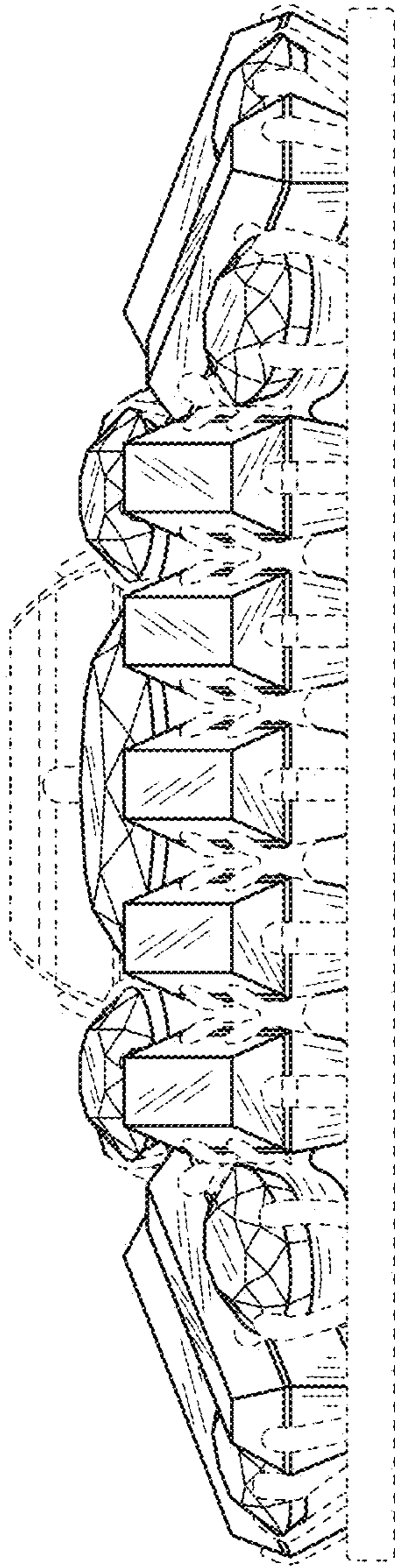

FIG. 10

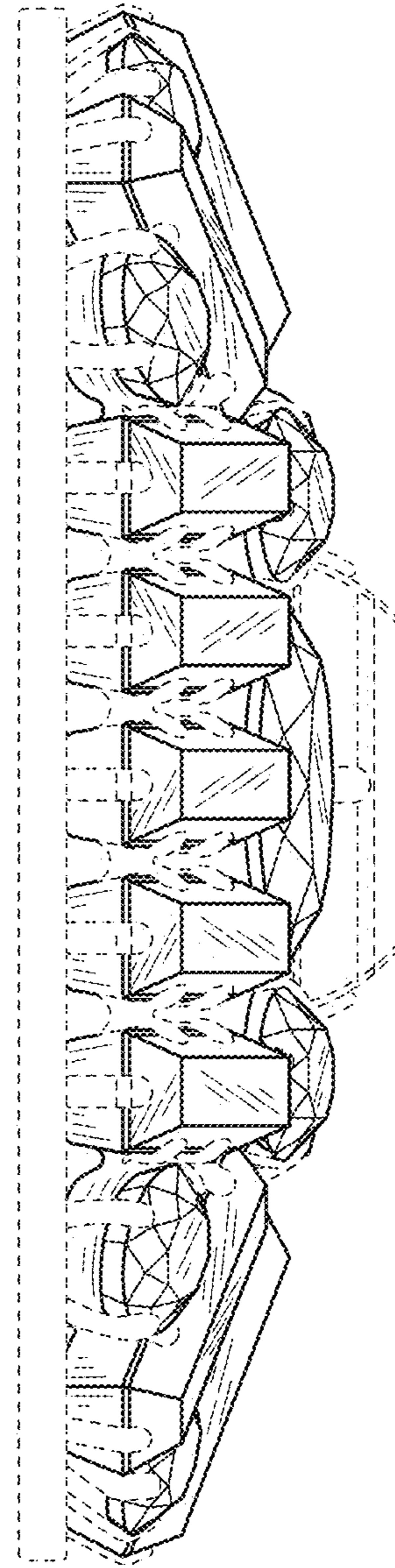

FIG. 11

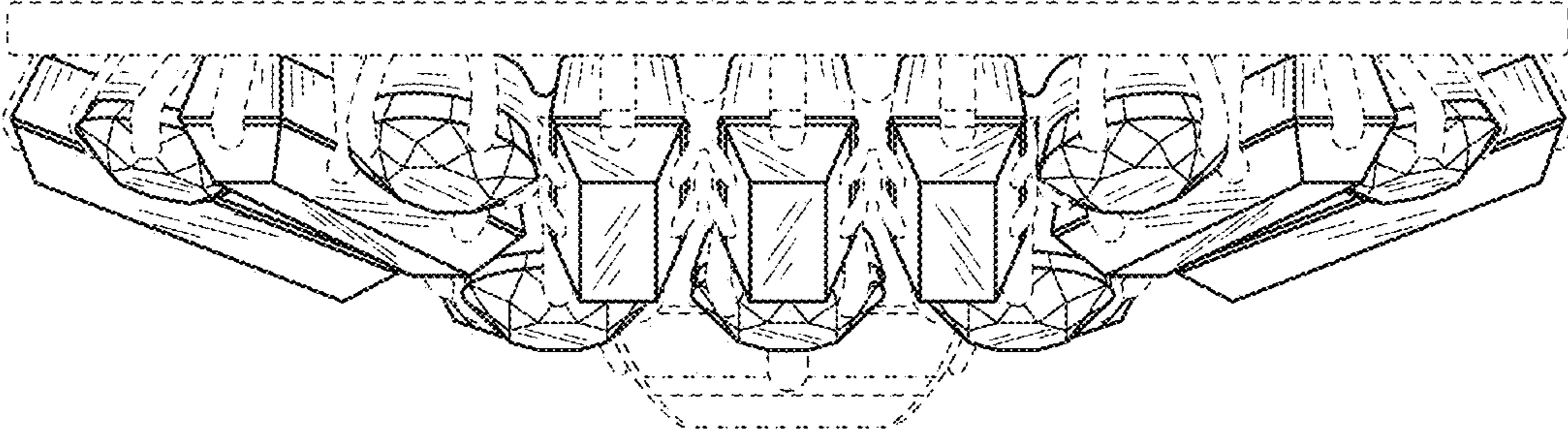

FIG. 12

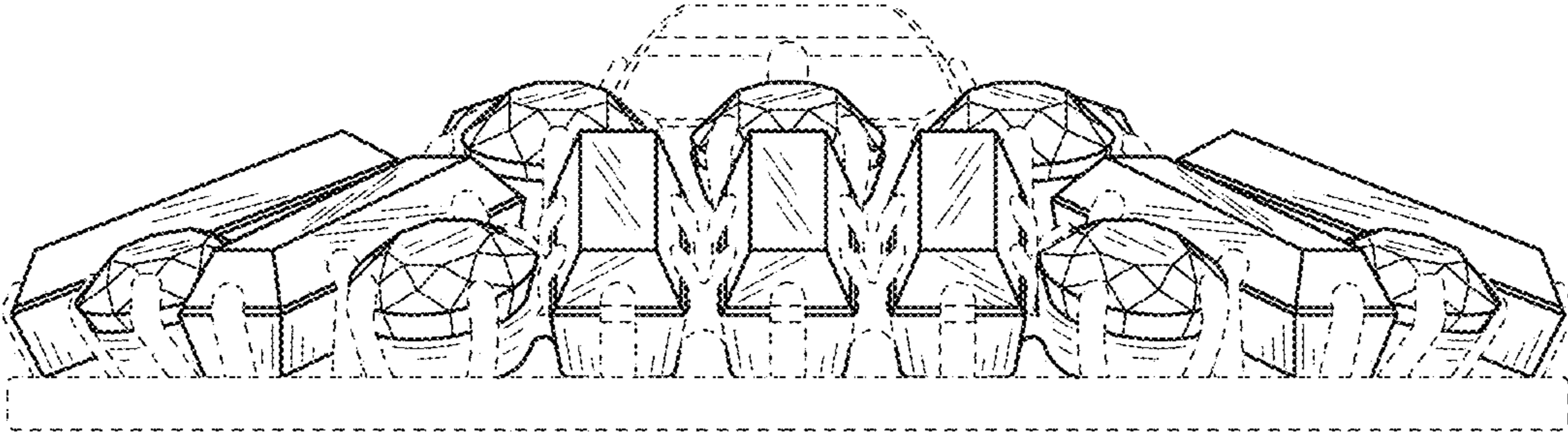

FIG. 13

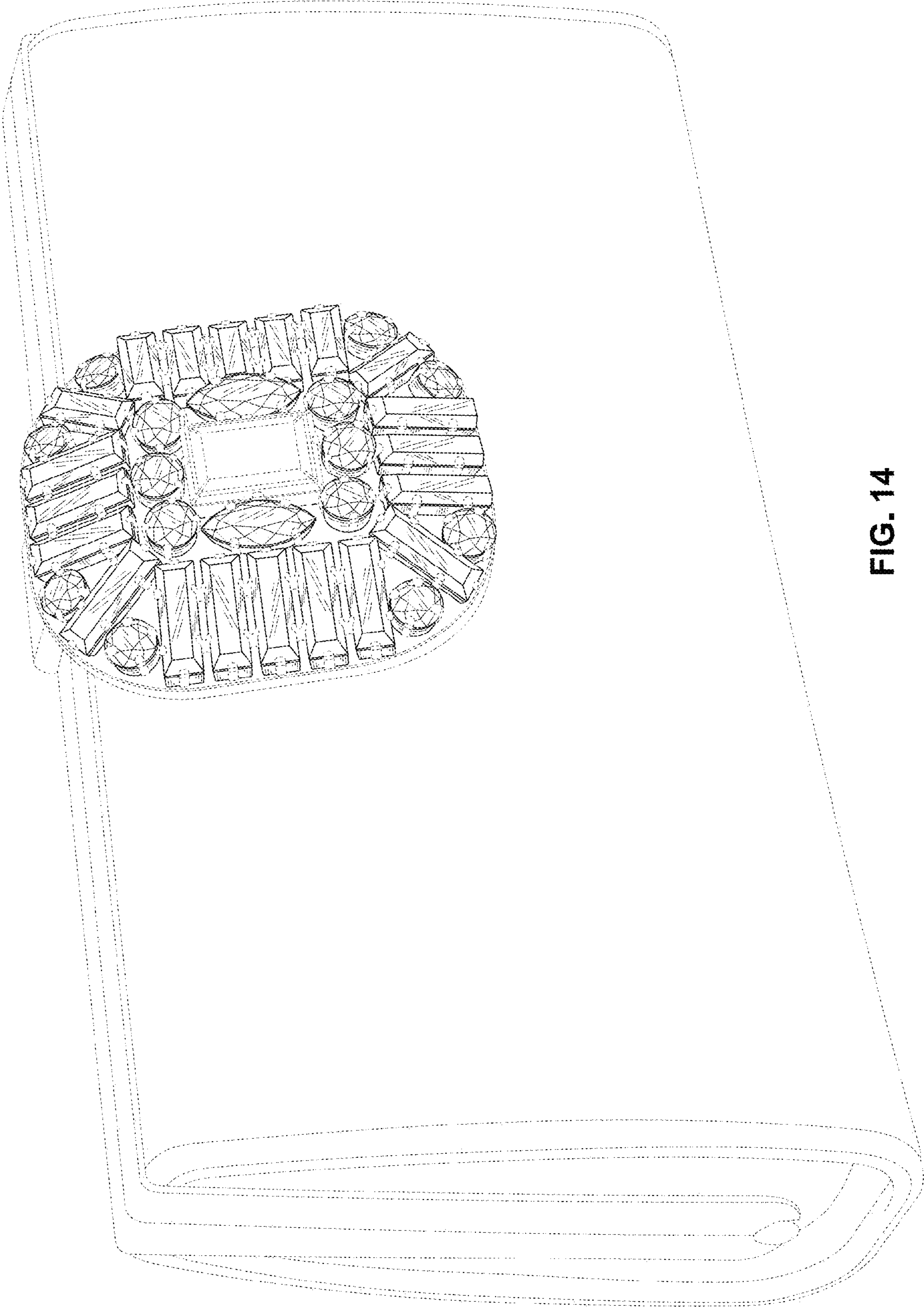

FIG. 14