



US00D919956S

(12) **United States Design Patent**
Xie

(10) **Patent No.:** **US D919,956 S**

(45) **Date of Patent:** **** May 25, 2021**

(54) **STORAGE BAG**

(71) Applicant: **Ming Xie**, Hangzhou (CN)

(72) Inventor: **Ming Xie**, Hangzhou (CN)

(73) Assignee: **HANGZHOU FREETRON INDUSTRIAL CO., LTD.**

(**) Term: **15 Years**

(21) Appl. No.: **29/759,108**

(22) Filed: **Nov. 20, 2020**

(30) **Foreign Application Priority Data**

Nov. 13, 2020 (CN) 202030689801.X

(51) **LOC (13) Cl.** **03-01**

(52) **U.S. Cl.**
USPC **D3/201**

(58) **Field of Classification Search**
USPC D3/201, 207, 208, 215, 226, 228, 229,
D3/230, 269, 273, 290, 299, 303, 304,
D3/316, 318

CPC B65D 83/384; F41H 9/10
See application file for complete search history.

(56) **References Cited**

U.S. PATENT DOCUMENTS

D467,079 S * 12/2002 Willows D3/301
D530,083 S * 10/2006 Guyon D3/246

D602,249 S * 10/2009 Stulman D3/245
D609,002 S * 2/2010 Sammons
D666,826 S * 9/2012 Phillips D3/303
D675,441 S * 2/2013 Phillips D3/303
D765,976 S * 9/2016 Wood D3/304
D784,020 S * 4/2017 Kutting A45C 13/02
D3/319
D802,919 S * 11/2017 Sellier
D831,344 S * 10/2018 Zeller D3/232
D862,072 S * 10/2019 Dong D3/232
D874,150 S * 2/2020 Liu D3/303
2017/0135453 A1 * 5/2017 Lo A45C 3/08

* cited by examiner

Primary Examiner — Holly E Thurman

(74) *Attorney, Agent, or Firm* — Zihua Han; Wen IP LLC

(57) **CLAIM**

The ornamental design for a storage bag, as shown and described.

DESCRIPTION

FIG. 1 is a front elevation view of a storage bag showing my new design;
FIG. 2 is a rear elevation view thereof;
FIG. 3 is a left side elevation view thereof;
FIG. 4 is a right side elevation view thereof;
FIG. 5 is a top plan view thereof;
FIG. 6 is a bottom plan view thereof;
FIG. 7 is a prospective view thereof; and,
FIG. 8 is another prospective view thereof, showing an alternative, open configuration of the storage bag.

1 Claim, 8 Drawing Sheets

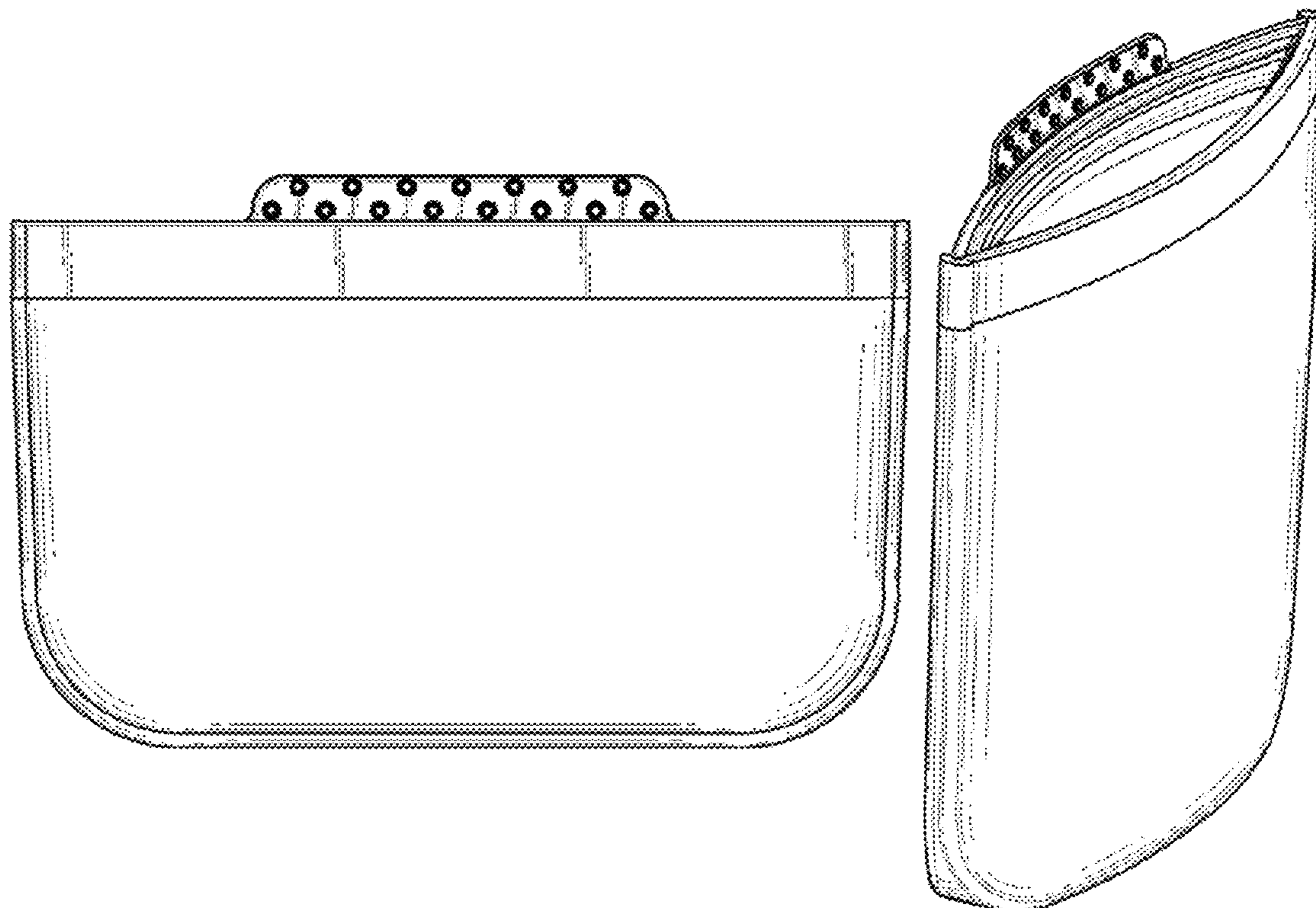

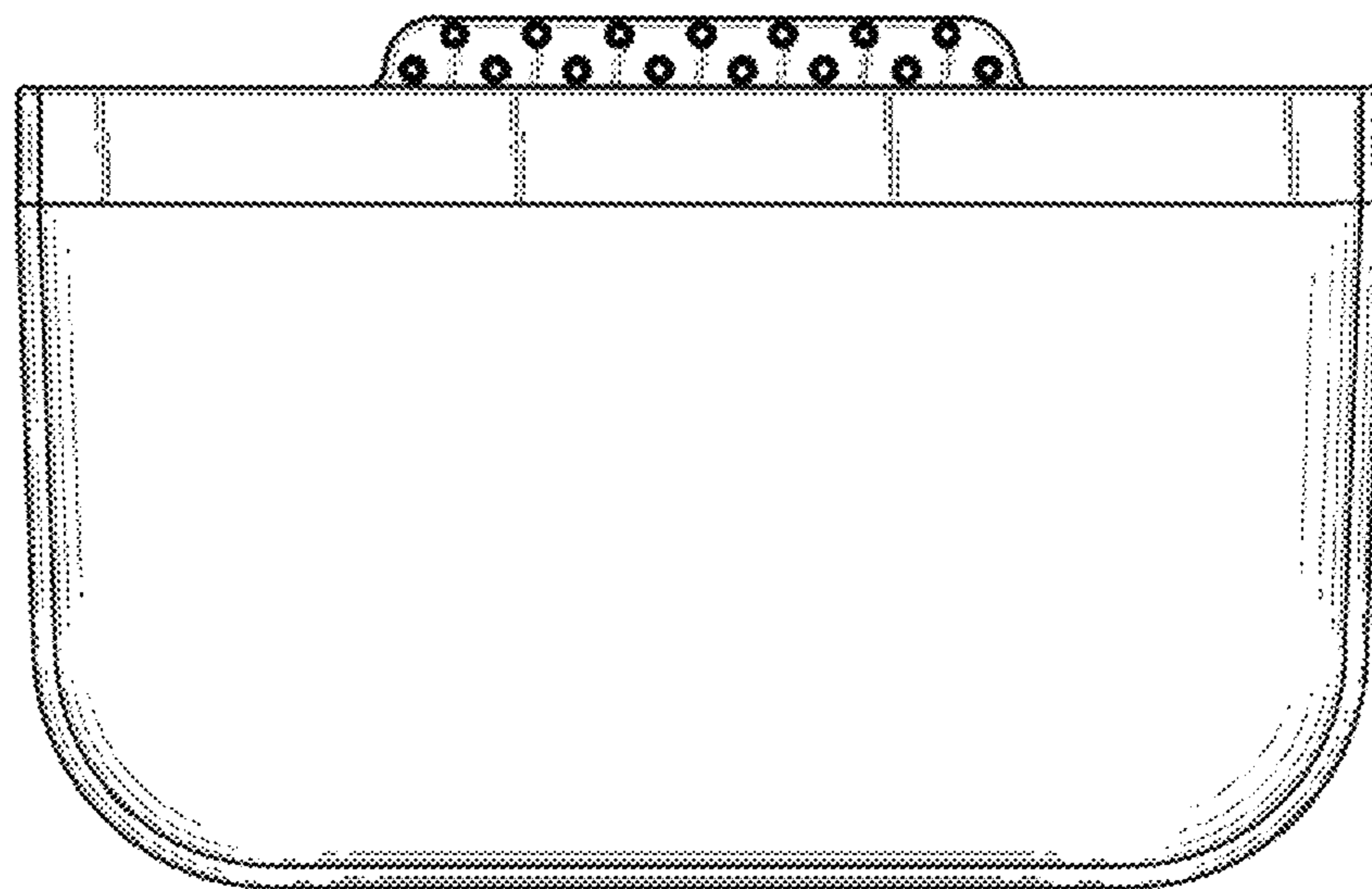

FIG. 1

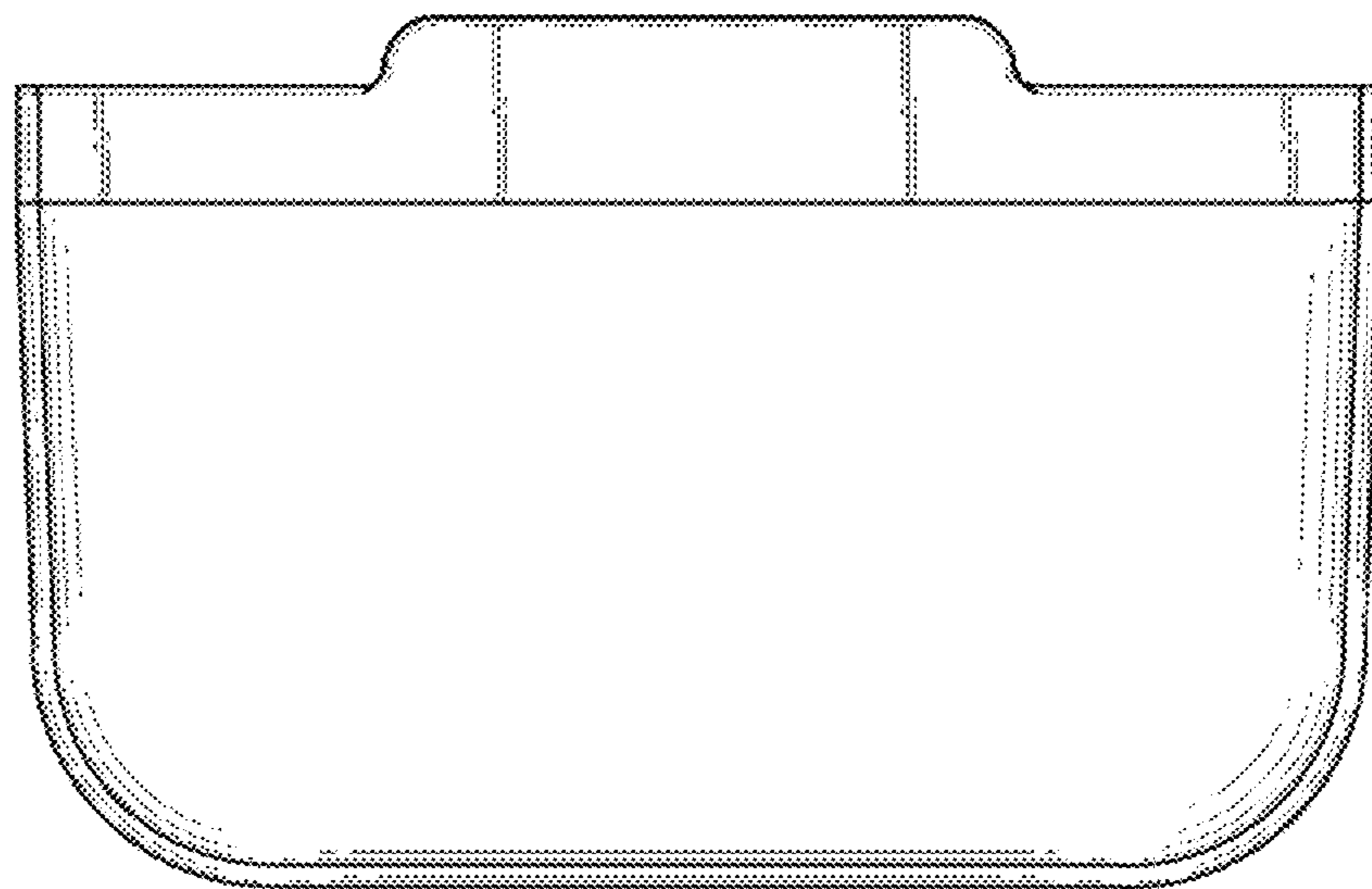

FIG. 2

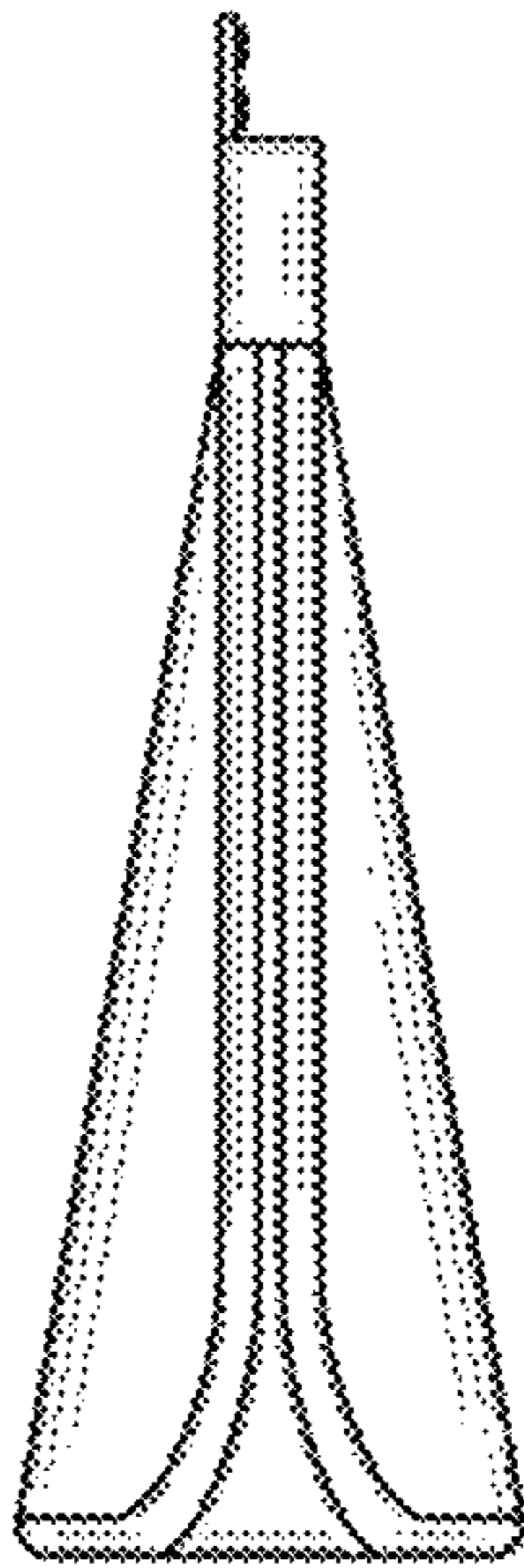

FIG. 3

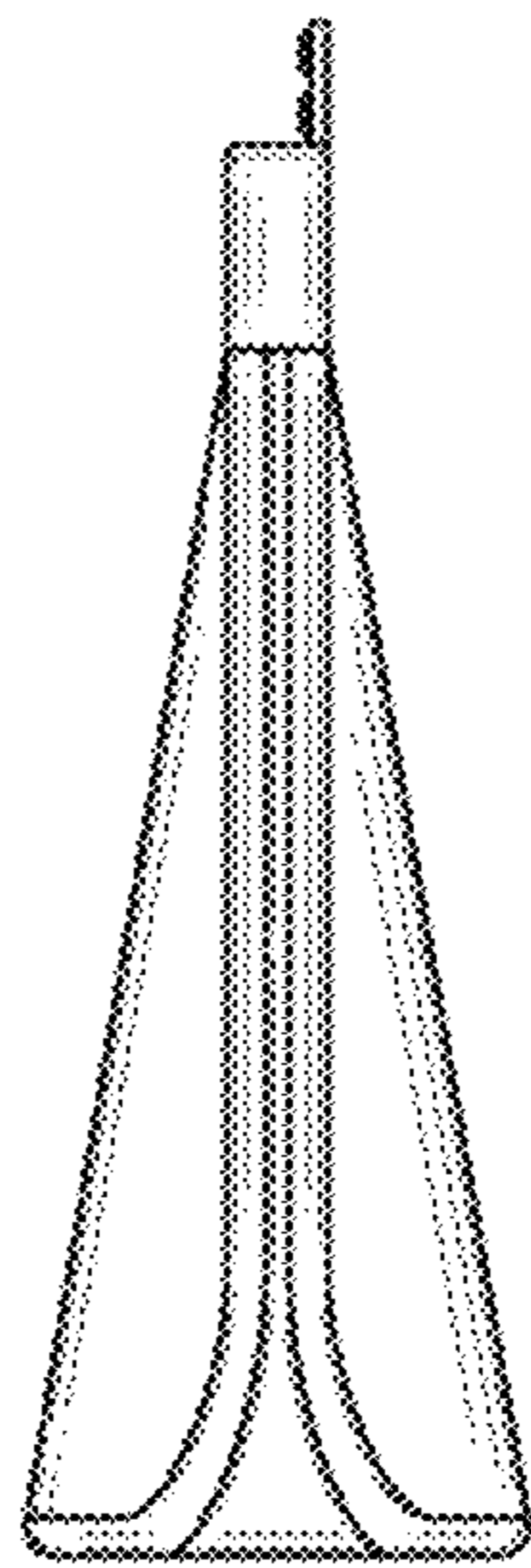

FIG. 4

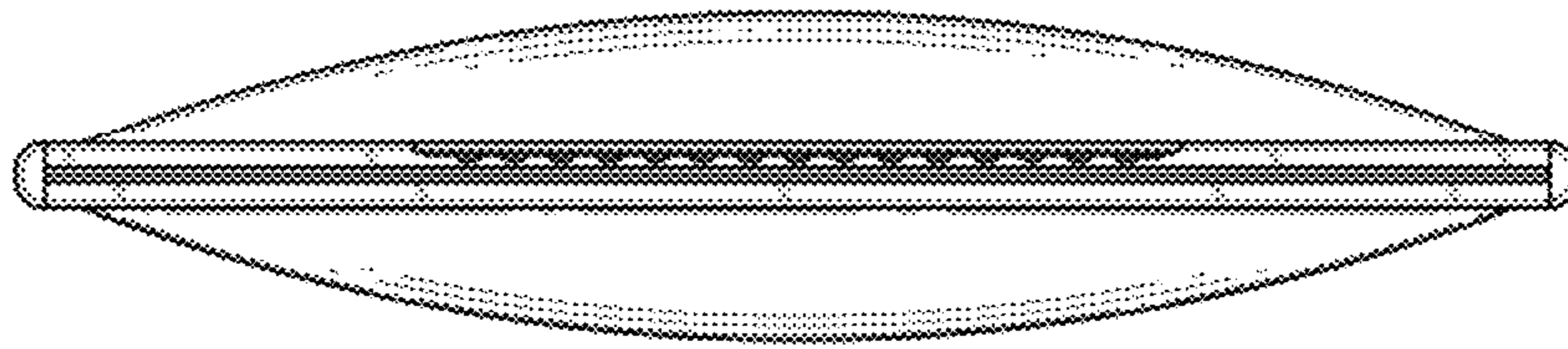

FIG. 5

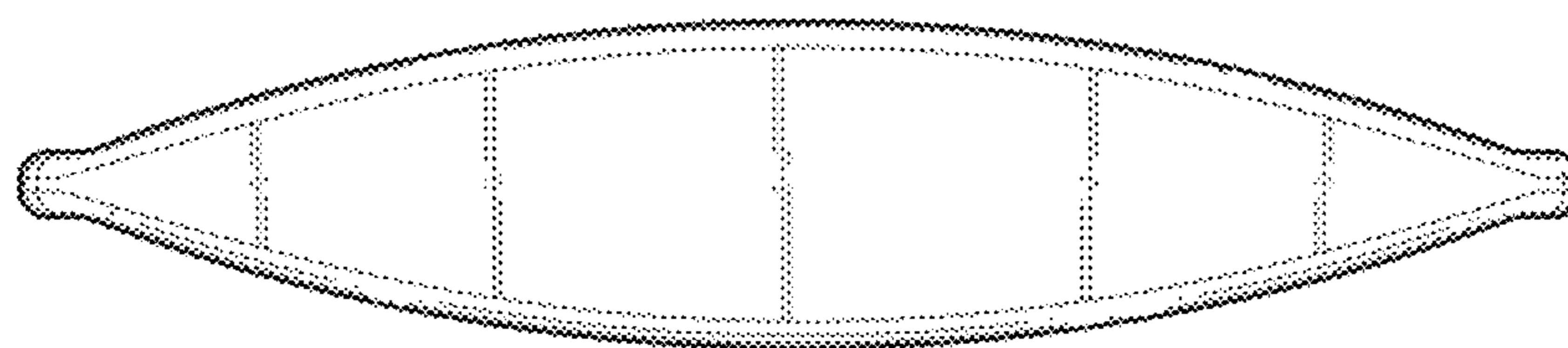

FIG. 6

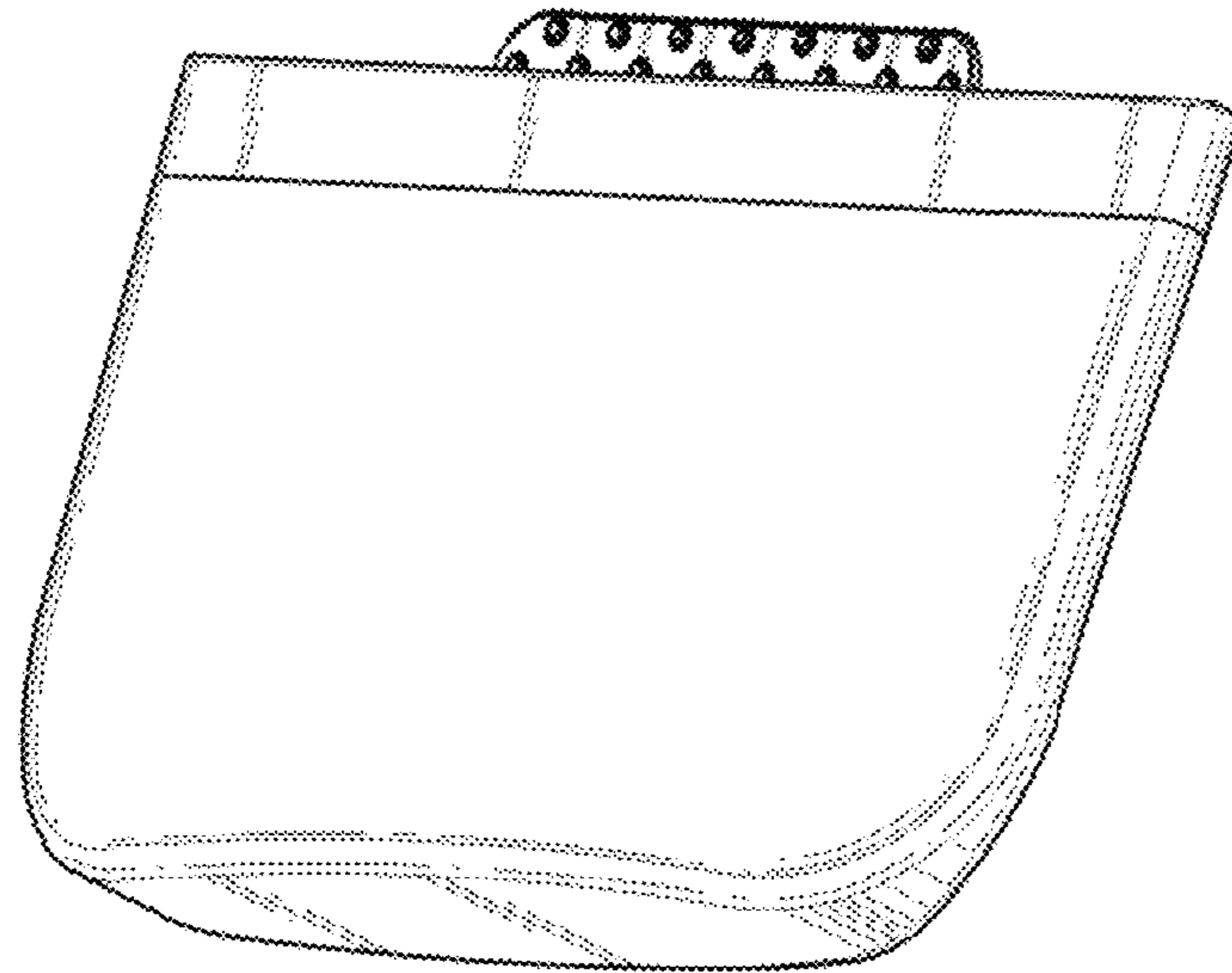

FIG. 7

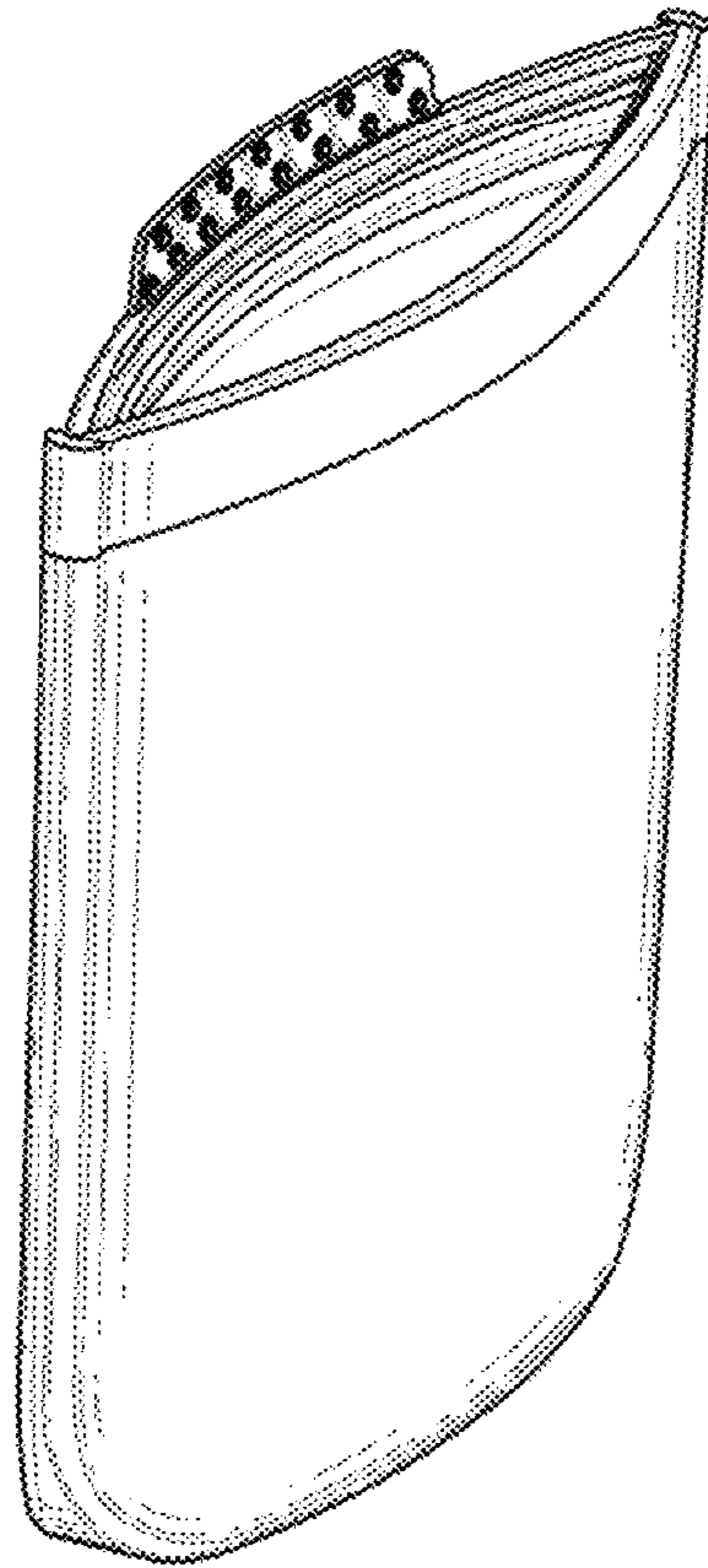

FIG. 8