



US00D919946S

(12) **United States Design Patent** (10) **Patent No.:** **US D919,946 S**  
**Kerr et al.** (45) **Date of Patent:** **\*\* May 25, 2021**

(54) **SHOE FOOTBED**  
(71) Applicant: **MDreams IP Holding Limited**, Hong Kong (CN)  
(72) Inventors: **Benjamin F. Kerr**, Hong Kong (CN); **Damon Butler**, Portland, OR (US)  
(73) Assignee: **MDREAMS IP HOLDING LIMITED**, North Point (HK)  
(\*\*) Term: **15 Years**  
(21) Appl. No.: **29/711,207**  
(22) Filed: **Oct. 29, 2019**  
(51) **LOC (13) Cl.** ..... **02-04**  
(52) **U.S. Cl.**  
USPC ..... **D2/947; D2/957; D2/960**  
(58) **Field of Classification Search**  
USPC ..... D2/902, 906, 908, 916, 917, 918, 925, D2/946-962, 977; 36/1, 1.5, 3 B, 22 R, 36/24.5, 25 R, 28, 32 R, 34 R, 59 C, 36/67 A, 101-107, 114-116, 117.3, 117.4, 36/124-136  
CPC ..... A43B 13/00; A43B 13/02; A43B 13/023; A43B 13/026; A43B 13/04; A43B 13/08; A43B 13/10; A43B 13/12; A43B 13/14; A43B 13/141; A43B 13/143; A43B 13/16; A43B 13/18; A43B 13/181; A43B 13/187; A43B 13/189; A43B 13/20; A43B 13/22; A43B 13/223; A43B 13/24; A43B 13/28; A43B 13/30; A43B 13/32; A43B 13/34; A43B 13/36  
See application file for complete search history.

(56) **References Cited**  
U.S. PATENT DOCUMENTS  
616,112 A 12/1898 Kennedy  
3,595,244 A \* 7/1971 Kugler ..... A43B 13/14  
36/141

4,078,321 A 3/1978 Famolare  
D251,096 S \* 2/1979 Young ..... D2/917  
4,438,573 A 3/1984 McBarron  
D275,145 S \* 8/1984 Glatz ..... D2/916  
D285,022 S \* 8/1986 Schornstein ..... D2/916  
D290,900 S \* 7/1987 Schornstein ..... D2/916  
4,910,882 A 3/1990 Göller  
(Continued)

**FOREIGN PATENT DOCUMENTS**

CN 2712122 7/2005

**OTHER PUBLICATIONS**

Ventolation Riley, Mdreams.com, [online], [site visited Nov. 19, 2020], <URL: <https://www.mdreams.com/collections/ventolation/products/ventolation-berry>> (Year: 2020).\*  
(Continued)

*Primary Examiner* — T Chase Nelson  
*Assistant Examiner* — Jonathan J. Han  
(74) *Attorney, Agent, or Firm* — Cozen O'Connor

(57) **CLAIM**

The ornamental design for a shoe footbed, as shown and described.

**DESCRIPTION**

FIG. 1 is a front perspective view of a shoe footbed in accordance with the design;  
FIG. 2 is a top view thereof;  
FIG. 3 is a right side view thereof;  
FIG. 4 is a left side view thereof;  
FIG. 5 is a front view thereof; and,  
FIG. 6 is a back view thereof.  
The portions shown in dashed broken lines depict environment that forms no part of the claimed design. The dot-dashed broken lines show boundaries of the claimed design and the dot-dash broken lines also form no part of the claimed design.

**1 Claim, 5 Drawing Sheets**

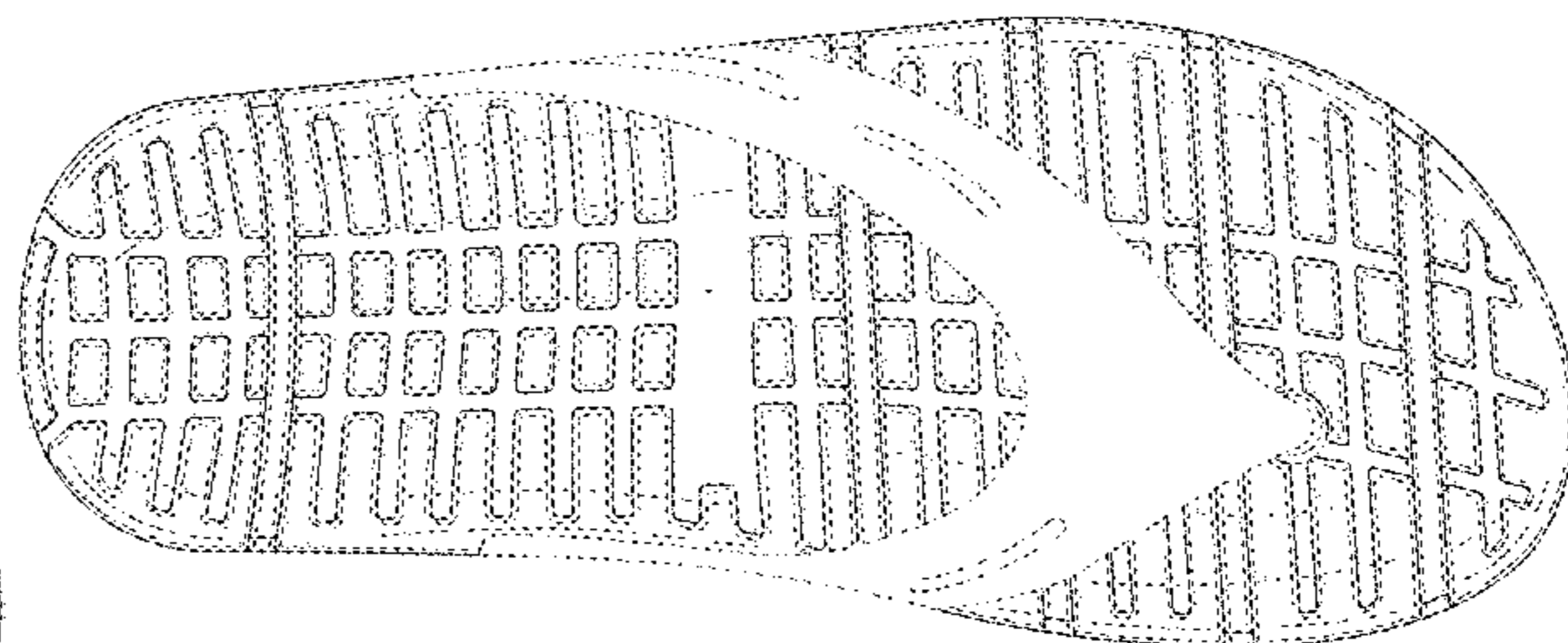
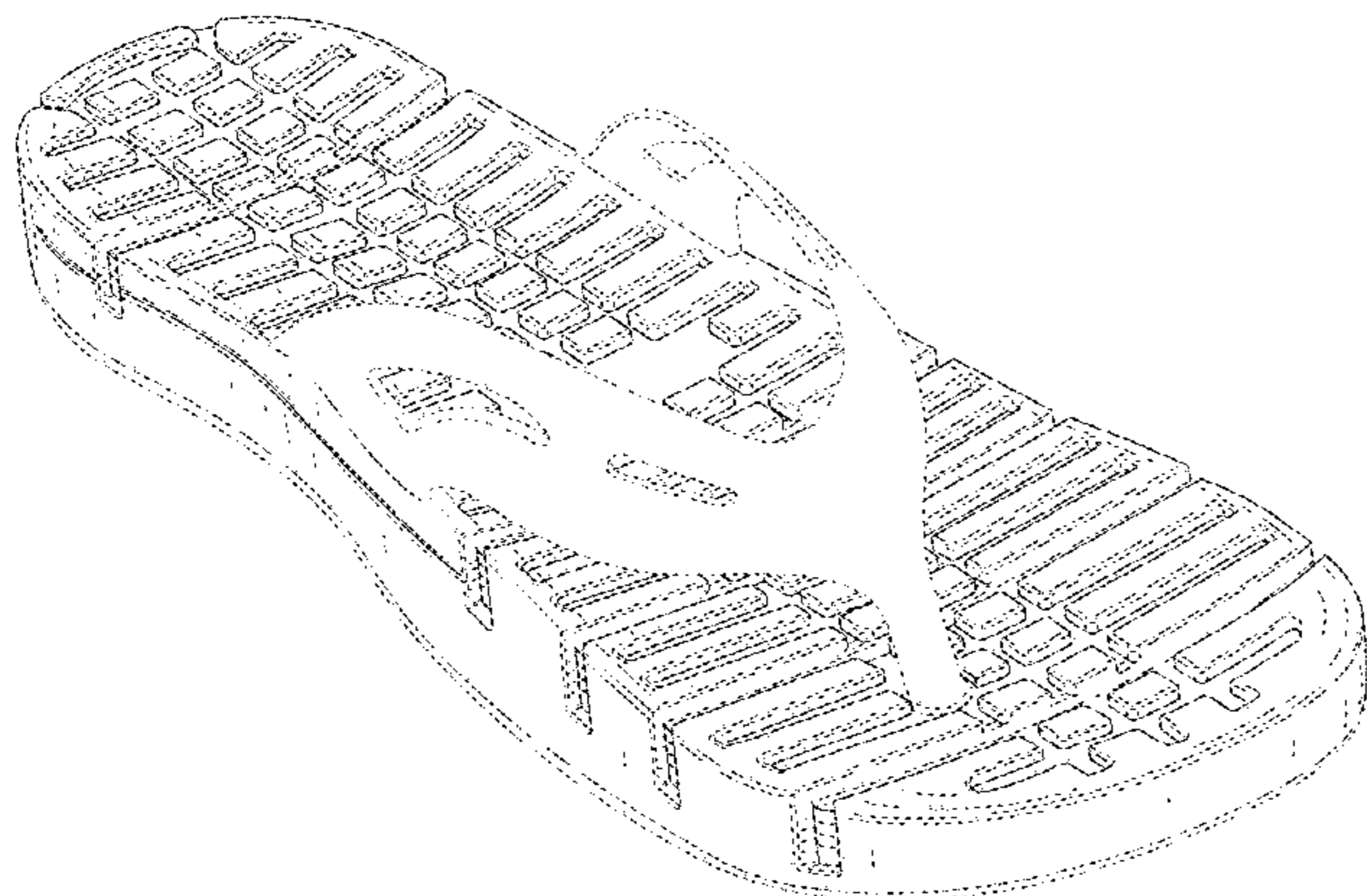

(56)

References Cited

U.S. PATENT DOCUMENTS

4,939,851 A 7/1990 Miller  
 5,400,526 A 3/1995 Sessa  
 D368,575 S \* 4/1996 McClain ..... D2/916  
 D384,493 S \* 10/1997 McClain ..... D2/916  
 D389,295 S \* 1/1998 Kelchak ..... D2/957  
 6,014,821 A 1/2000 Yaw  
 D437,677 S \* 2/2001 Matis ..... D2/916  
 D478,713 S \* 8/2003 Scheurer ..... D2/917  
 6,701,640 B2 3/2004 Nakano  
 D505,537 S \* 5/2005 Friedman ..... D2/961  
 D566,499 S \* 4/2008 Welch ..... D8/38  
 7,367,142 B2 5/2008 Ferniani et al.  
 D573,780 S \* 7/2008 Davis ..... D2/951  
 7,748,141 B2 7/2010 Smith et al.  
 8,015,729 B2 9/2011 Mizrahi Shapiro  
 D658,856 S \* 5/2012 Van Zyll De Jong ..... D2/946  
 D659,956 S 5/2012 Huynh  
 D660,557 S 5/2012 Huynh  
 D660,558 S 5/2012 Huynh  
 D663,511 S \* 7/2012 Martinez ..... D2/917  
 D668,845 S 10/2012 Huynh  
 D701,380 S \* 3/2014 Reed ..... D2/960  
 D707,020 S \* 6/2014 Wakeland ..... D2/917  
 8,776,396 B2 7/2014 Huyhn  
 D712,645 S \* 9/2014 Bove ..... D2/960  
 D779,177 S \* 2/2017 Gibson ..... D2/951  
 D794,923 S \* 8/2017 Maurer ..... D2/917  
 D802,897 S \* 11/2017 Howe ..... D2/953  
 D815,815 S \* 4/2018 Moore ..... D2/947  
 D822,963 S \* 7/2018 Moore ..... D2/947  
 D827,257 S \* 9/2018 Ringholz ..... D2/916  
 D828,990 S \* 9/2018 Evans ..... D2/961  
 D843,095 S \* 3/2019 Birkinhead ..... D2/957  
 D845,597 S \* 4/2019 Barnes ..... D2/957  
 D847,478 S \* 5/2019 Fracassi ..... D2/957

D852,481 S \* 7/2019 Liu ..... D2/957  
 D880,116 S \* 4/2020 Post ..... D2/916  
 6,076,282 A1 6/2020 Brue'  
 D889,079 S \* 7/2020 West ..... D2/926  
 D889,103 S \* 7/2020 Auger ..... D2/961  
 D895,951 S \* 9/2020 Hardigan ..... D2/957  
 2002/0007568 A1 1/2002 Kellerman et al.  
 2005/0150132 A1 \* 7/2005 Iannacone ..... A43B 7/146  
 36/11.5  
 2008/0022561 A1 \* 1/2008 Klavano ..... A43B 7/146  
 36/141  
 2008/0178496 A1 7/2008 Lin et al.  
 2012/0174439 A1 \* 7/2012 O'Connor ..... A43B 7/142  
 36/91  
 2013/0239435 A1 \* 9/2013 McDowell ..... A43B 3/108  
 36/11.5  
 2017/0231321 A1 \* 8/2017 Tremblay ..... A43B 1/0027  
 36/93

OTHER PUBLICATIONS

Dune-Ast Men's Flip Flop Sandals Soft Cushion Footbed for Beach, Lounging Pool—Boy's Summer Slippers—Non-Slip Water-Friendly for Shower, Amazon.com, Date First Available: May 21, 2020, [online], [site visited Nov. 19, 2020], <URL: <https://www.amazon.com/Dune-Ast-Sandals-Cushion-Footbed-Lounging/dp>> (Year: 2020).\*

Feliz—Flip-Flop Sandal, DockersShoes.com, [online], [site visited Nov. 19, 2020], <URL: <https://www.dockershoes.com/products/dockers-felix-flip-flop-sandal>> (Year: 2020).\*

Nike WMNS Roshe Run Print 0 Black/Cool Grey-Pink Club, SoleCollector.com, Jun. 13, 2013, [online], [site visited Nov. 19, 2020], <URL: <https://solecollector.com/news/2013/06/nike-wmns-roshe-run-print-black-cool-grey-pink-club>> (Year: 2013).\*

\* cited by examiner

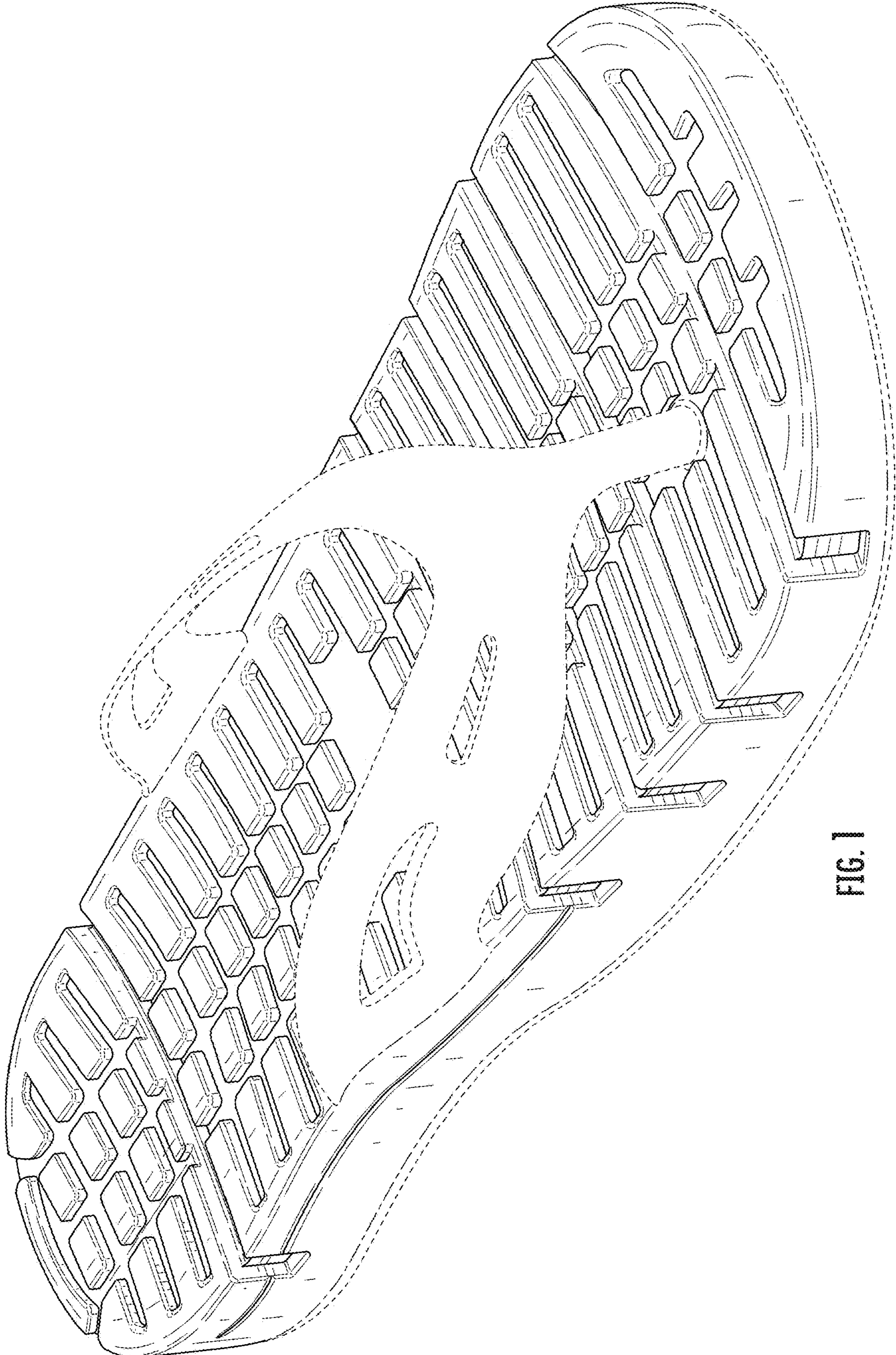

FIG. 1

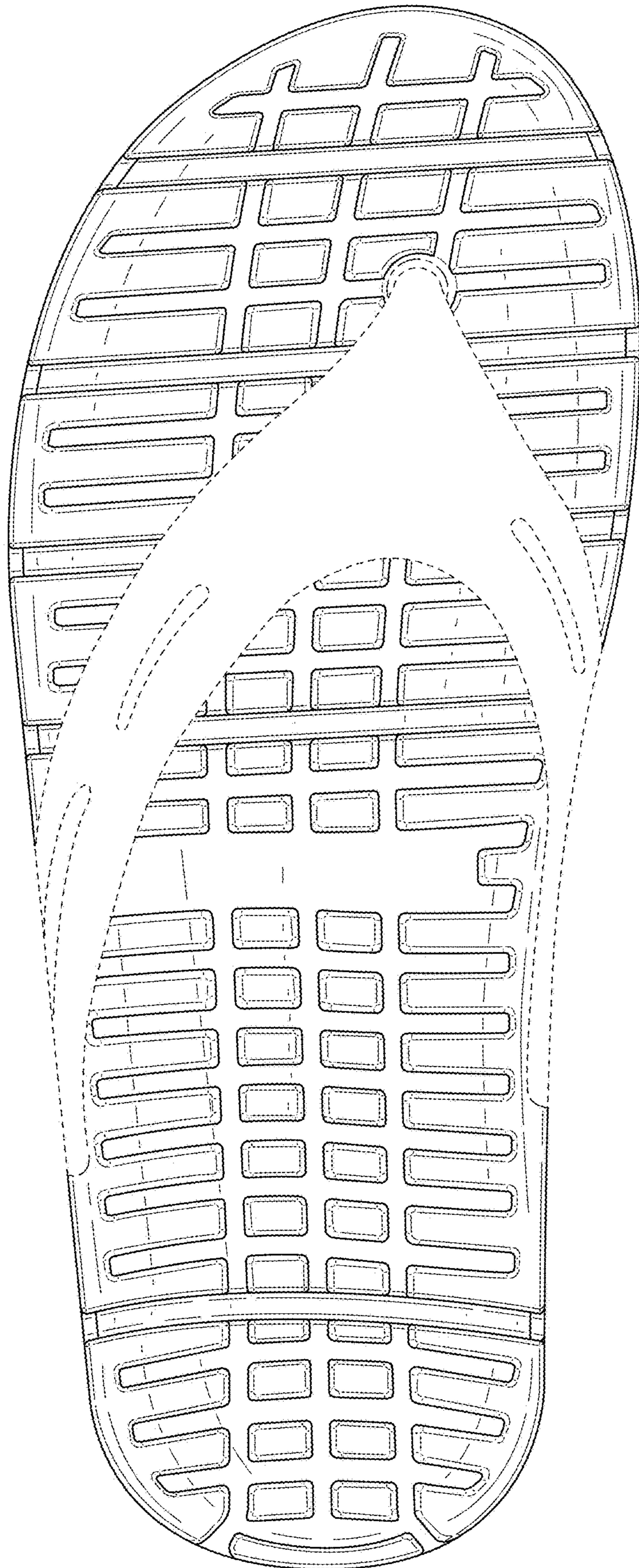

FIG. 2

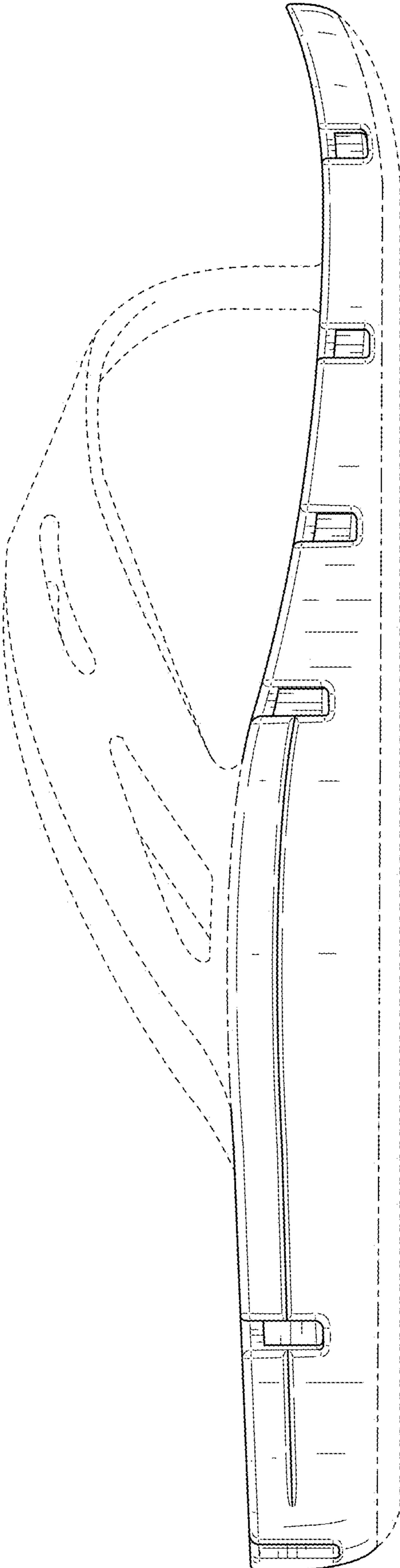

FIG. 3

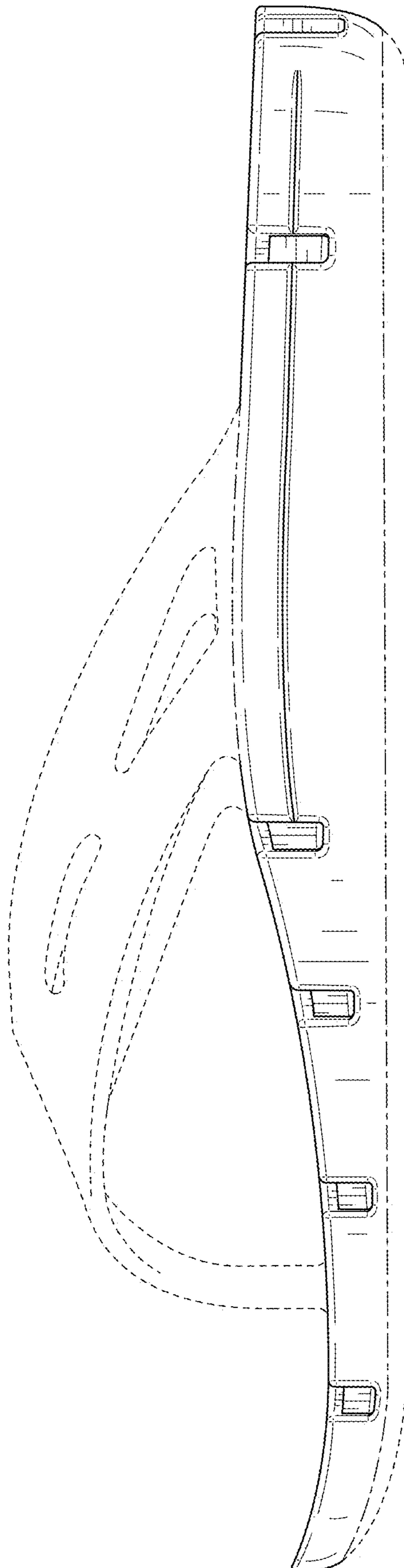

FIG. 4

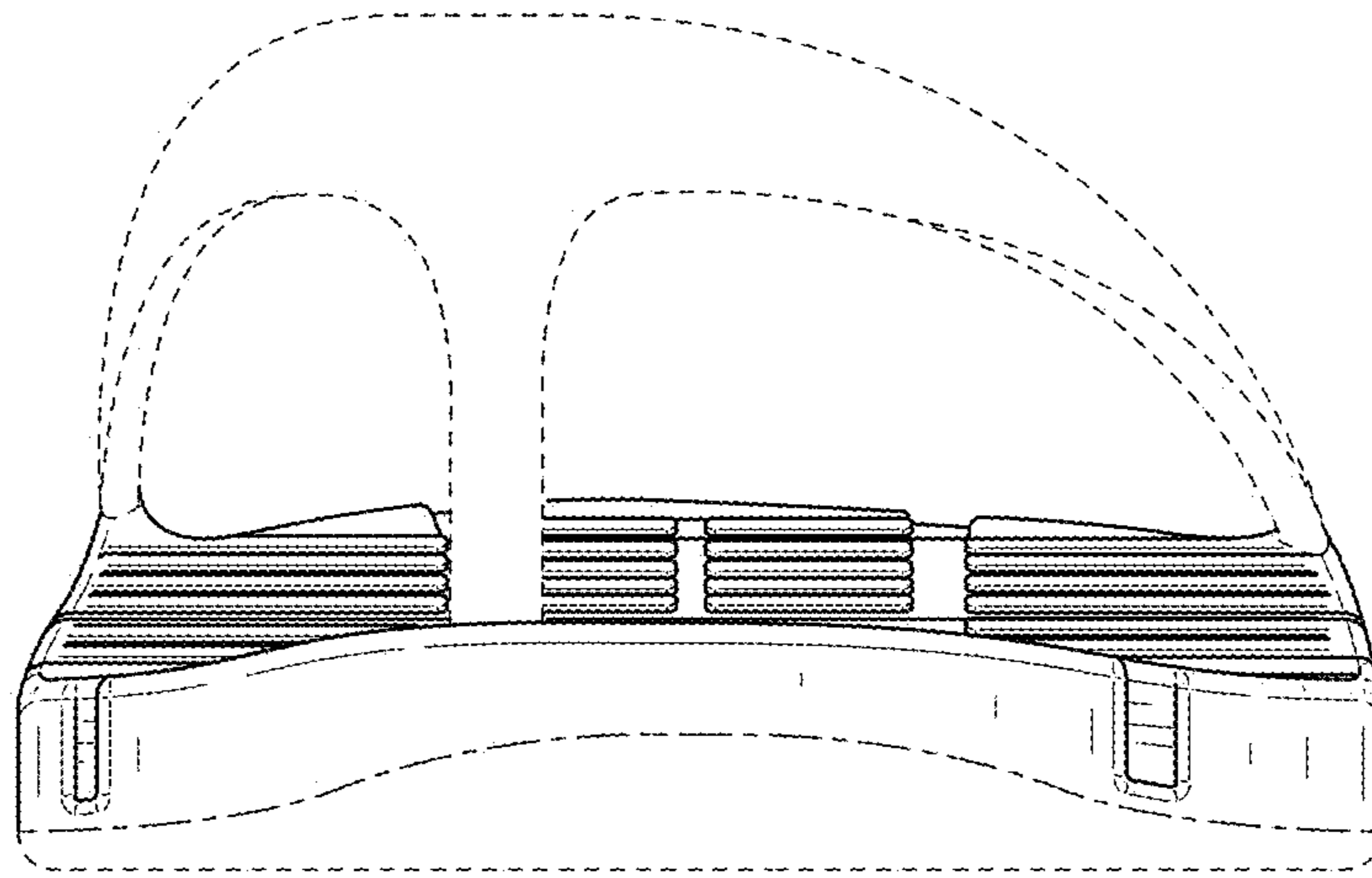

FIG. 5

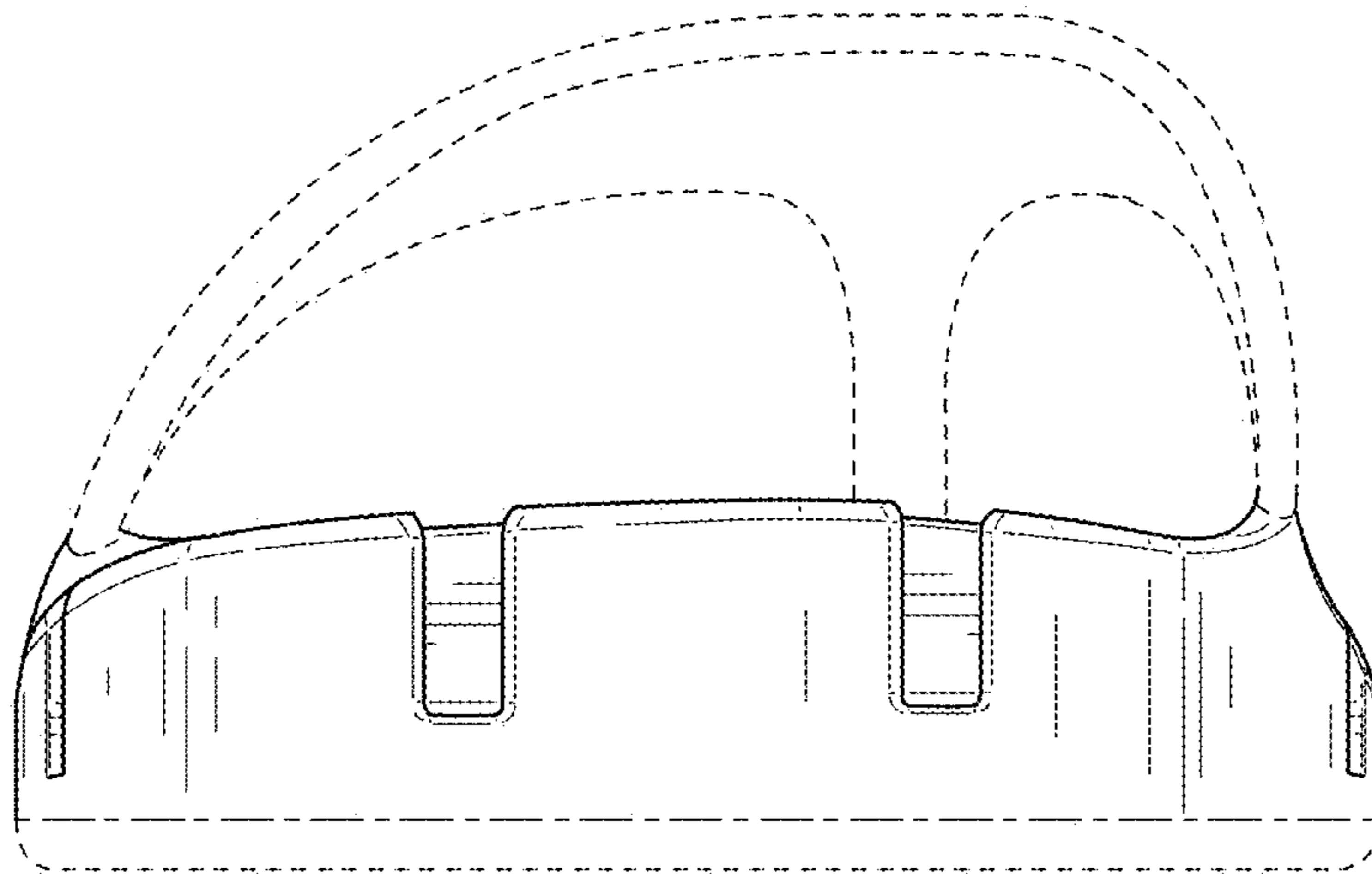

FIG. 6