



US00D919911S

(12) **United States Design Patent** (10) **Patent No.:** **US D919,911 S**  
**Kim et al.** (45) **Date of Patent:** **\*\* May 18, 2021**

(54) **DOOR FOR WASHING MACHINE**

(71) Applicant: **LG ELECTRONICS INC.**, Seoul (KR)

(72) Inventors: **Hyewon Kim**, Seoul (KR); **Junghwan Lee**, Seoul (KR); **Hoil Jeon**, Seoul (KR); **Nerry Son**, Seoul (KR)

(73) Assignee: **LG Electronics Inc.**, Seoul (KR)

(\*\*) Term: **15 Years**

(21) Appl. No.: **35/508,543**

(22) Filed: **Aug. 14, 2019**

(80) **Hague Agreement Data**

Int. Filing Date: **Aug. 14, 2019**

Int. Reg. No.: **DM/204216**

Int. Reg. Date: **Aug. 14, 2019**

Int. Reg. Pub. Date: **Feb. 14, 2020**

(51) **LOC (13) Cl.** ..... **32-03**

(52) **U.S. Cl.**  
USPC ..... **D32/25**

(58) **Field of Classification Search**

USPC .... D32/2, 6-13, 55, 56, 58, 25-31; D6/410, D6/411, 462, 546, 548, 553, 567, 574, D6/566; D23/271, 273, 284, 286, 308

CPC ..... D06F 33/02; D06F 39/14; D06F 37/304; D06F 39/005; D06F 39/12; D06F 37/04; D06F 39/02; D06F 29/00; D06F 37/203; D06F 37/28; D06F 37/30; D06F 58/02; D06F 2204/065; D06F 2222/00; D06F 29/005; D06F 29/02; D06F 31/00; D06F 33/00; D06F 37/10; D06F 37/12; D06F 37/36; D06F 58/206; D06F 58/22; D06F 58/24; D06F 17/08; D06F 1/04; D06F 2058/2803; D06F 2202/00; D06F 2202/02; D06F 2202/065; D06F 2202/12; D06F 2204/02; D06F 2204/086; D06F 2224/00; D06F 2232/00; D06F 2232/08; D06F 23/04; D06F 35/00; D06F 35/005;

D06F 35/006; D06F 35/007; D06F 37/00; D06F 37/02; D06F 37/225; D06F 37/263; D06F 37/266; D06F 37/268; D06F 37/40; D06F 37/42; D06F 39/003; D06F 39/004; D06F 39/007; D06F 39/08; D06F 39/088; D06F 39/125; D06F 58/203; D06F 58/28; D06F 81/06

See application file for complete search history.

(56) **References Cited**

U.S. PATENT DOCUMENTS

D506,045 S *	6/2005	No	.....	D32/25
D525,753 S *	7/2006	Schoene	.....	D32/25
D588,315 S *	3/2009	Geyer	.....	D32/25
D848,690 S *	5/2019	Ostdiek	.....	D32/25
D856,615 S *	8/2019	Harbrecht	.....	D32/25
D865,306 S *	10/2019	Polonsky	.....	D32/25
D876,038 S *	2/2020	Yoon	.....	D32/25
D883,593 S *	5/2020	Lee	.....	D32/25

(Continued)

*Primary Examiner* — Khawaja Anwar

(74) *Attorney, Agent, or Firm* — Birch, Stewart, Kolasch & Birch, LLP

(57) **CLAIM**

The ornamental design for door for washing machine, as shown and described.

**DESCRIPTION**

1. Door for washing machine

1.1 : Perspective

1.2 : Rear perspective view

1.3 : Front

1.4 : Back

1.5 : Left

1.6 : Right

1.7 : Top

1.8 : Bottom

(Continued)

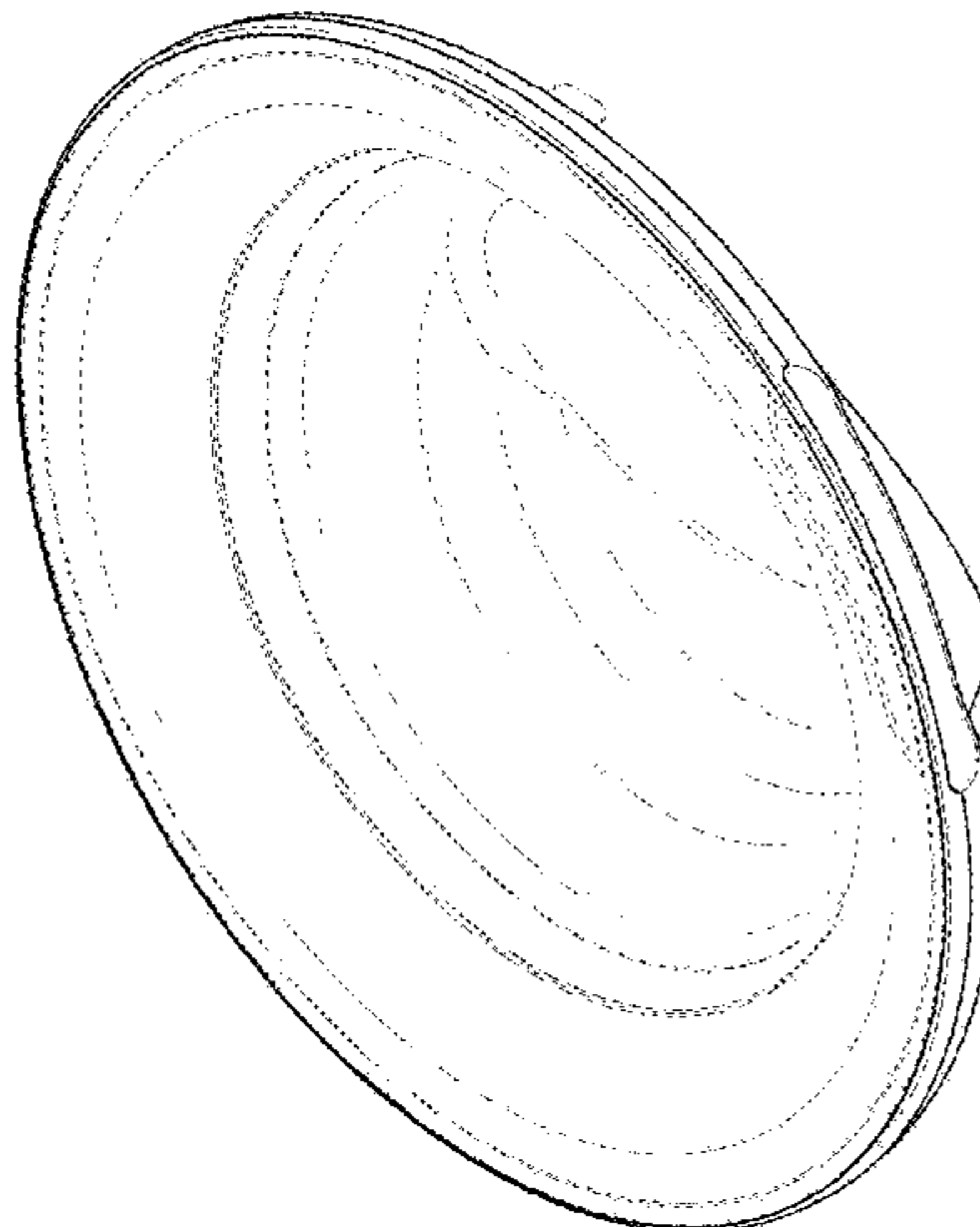

The broken lines indicate portions of the article that form no part of the claimed design; the window glass of door for washing machines is transparent material.

**1 Claim, 8 Drawing Sheets**

(56)

**References Cited**

U.S. PATENT DOCUMENTS

D883,594 S	*	5/2020	Lee	.....	D32/25
D883,595 S	*	5/2020	Lee	.....	D32/25
D899,720 S	*	10/2020	Schelling	.....	D32/25
D902,512 S	*	11/2020	Yoon	.....	D32/25

\* cited by examiner

1.1

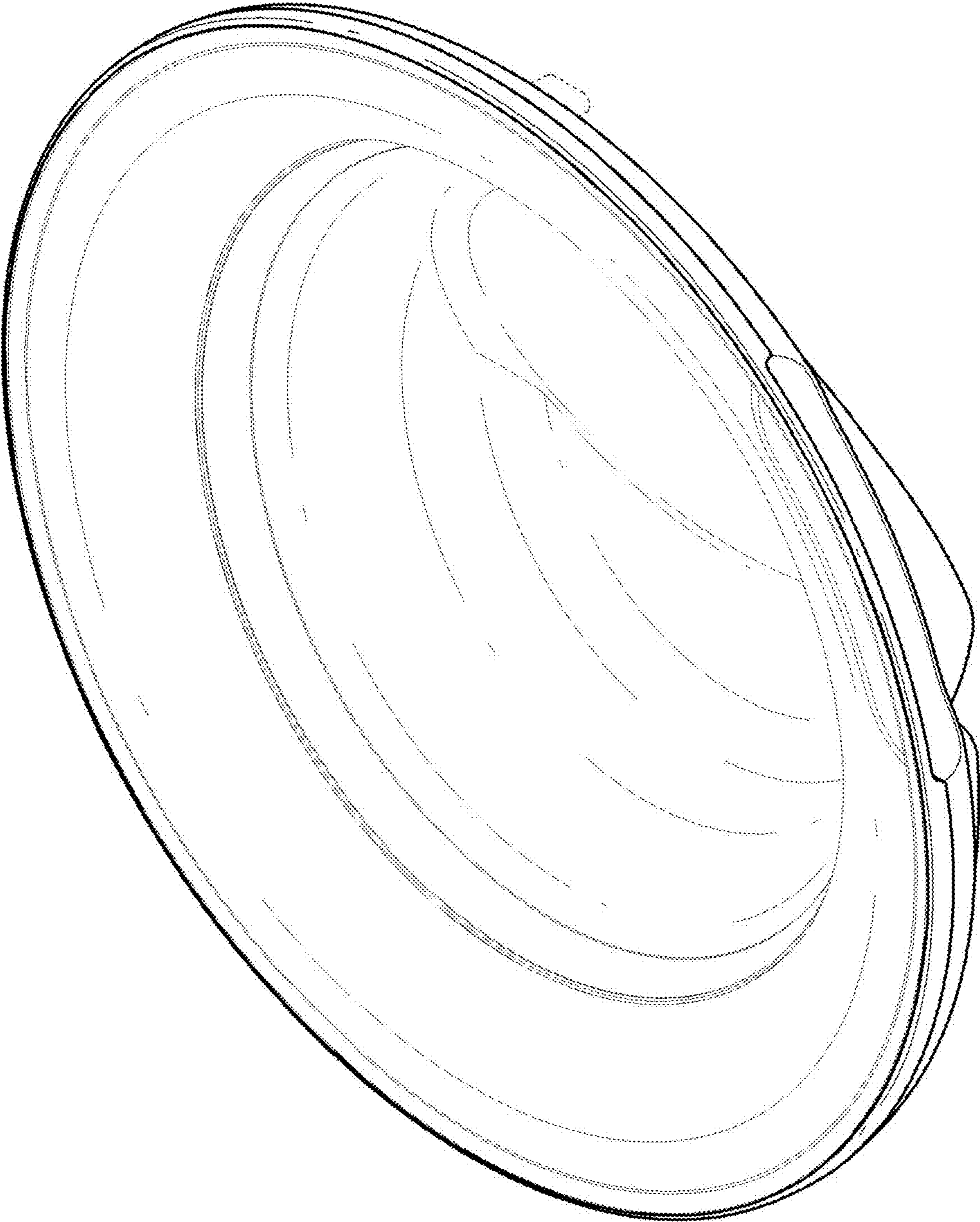



1.2

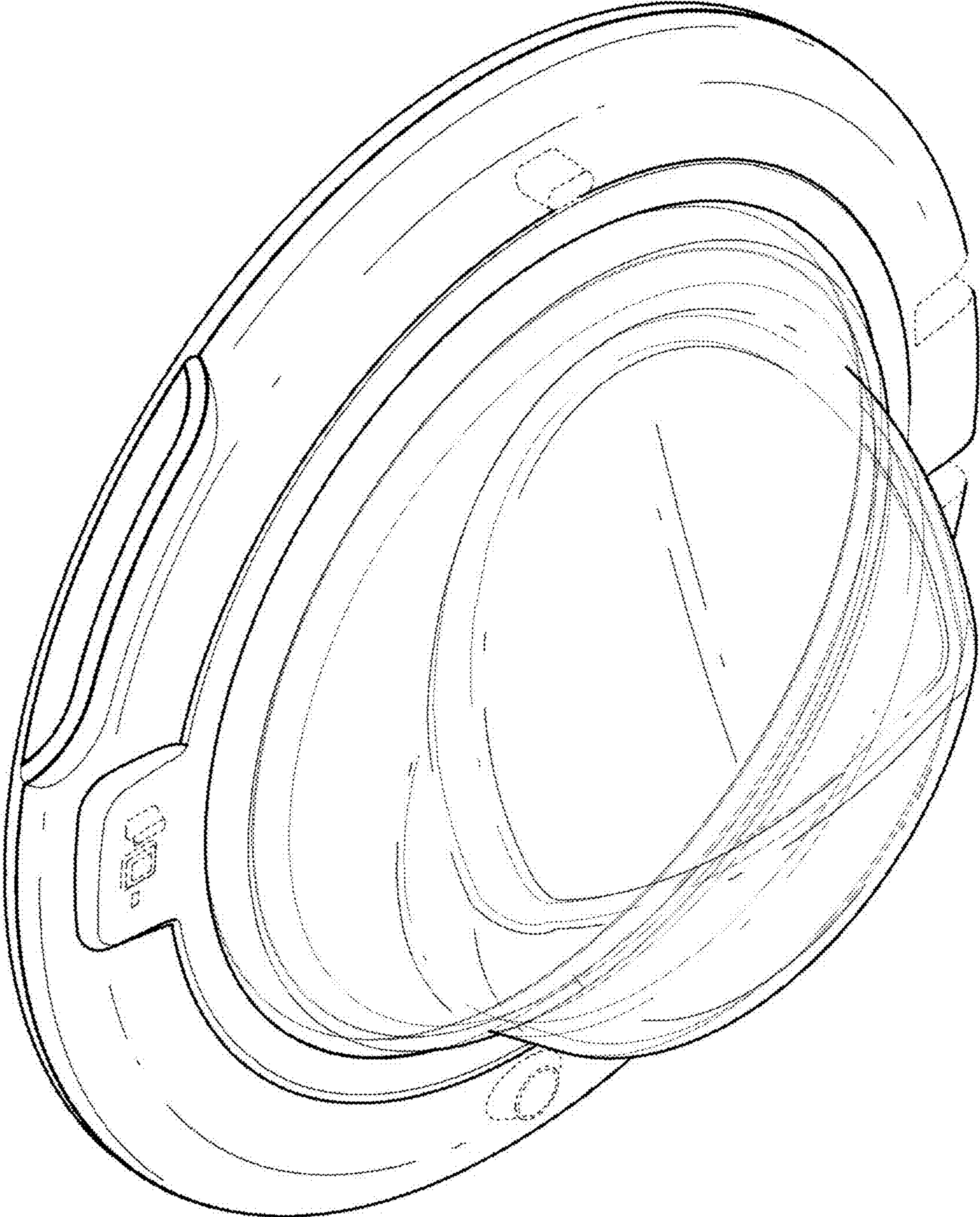

1.3

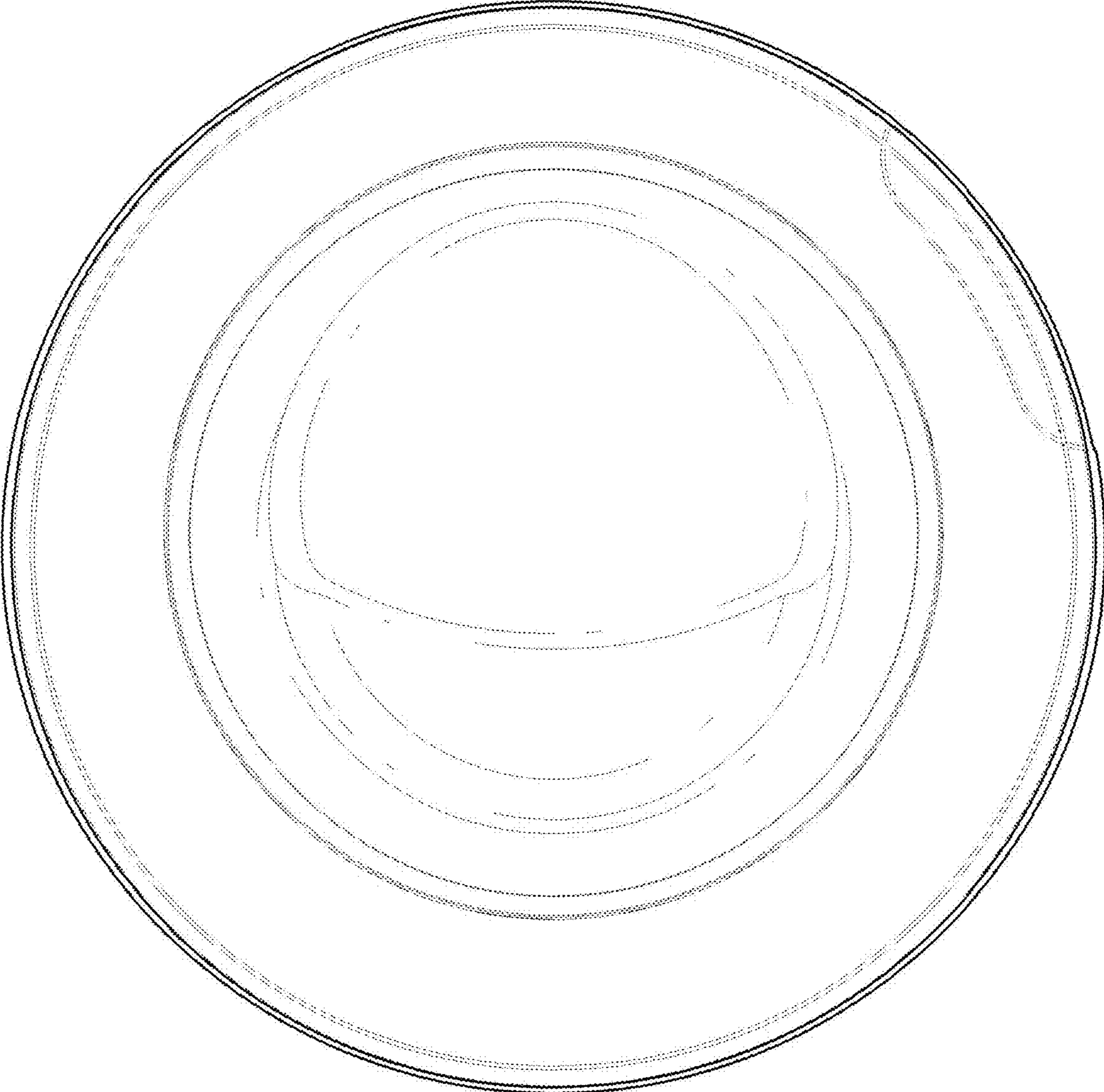

1.4

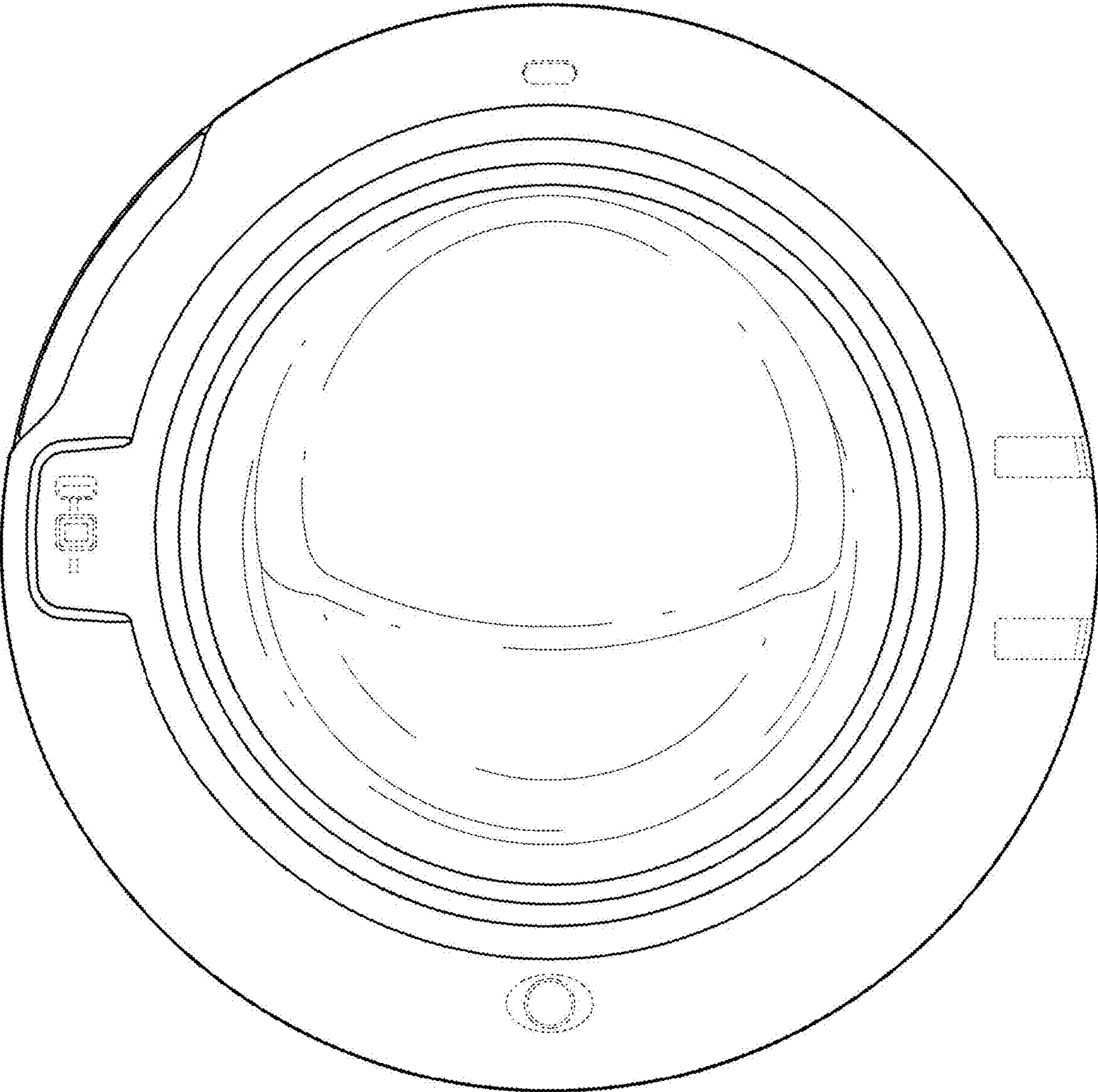

1.5

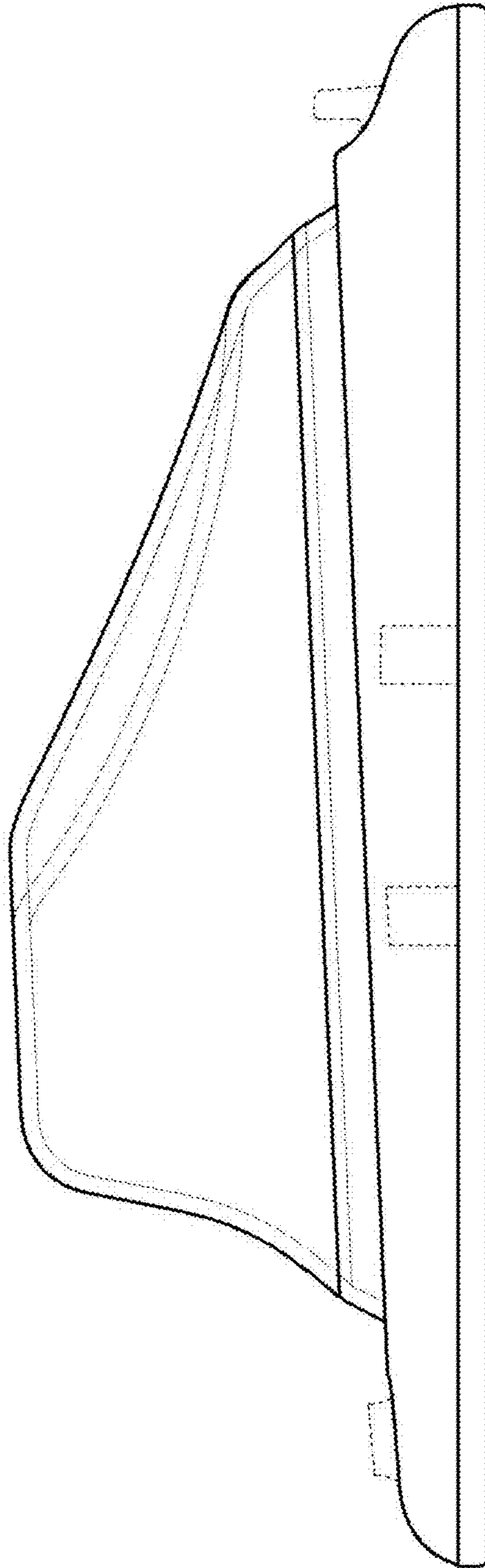



1.6

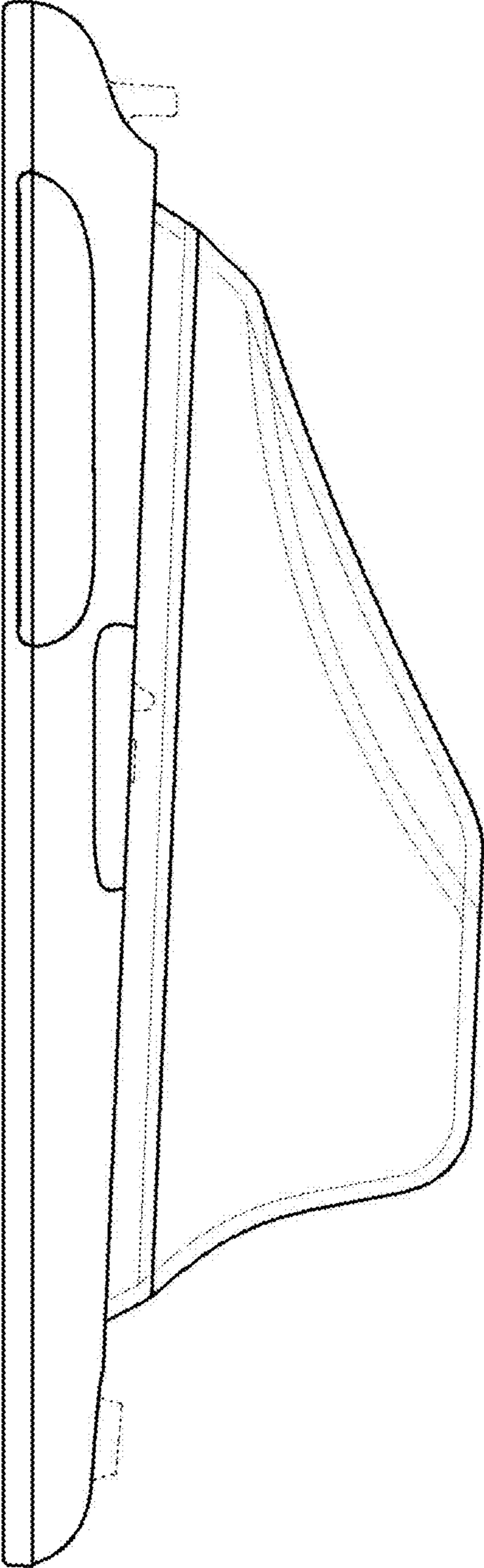



1.7

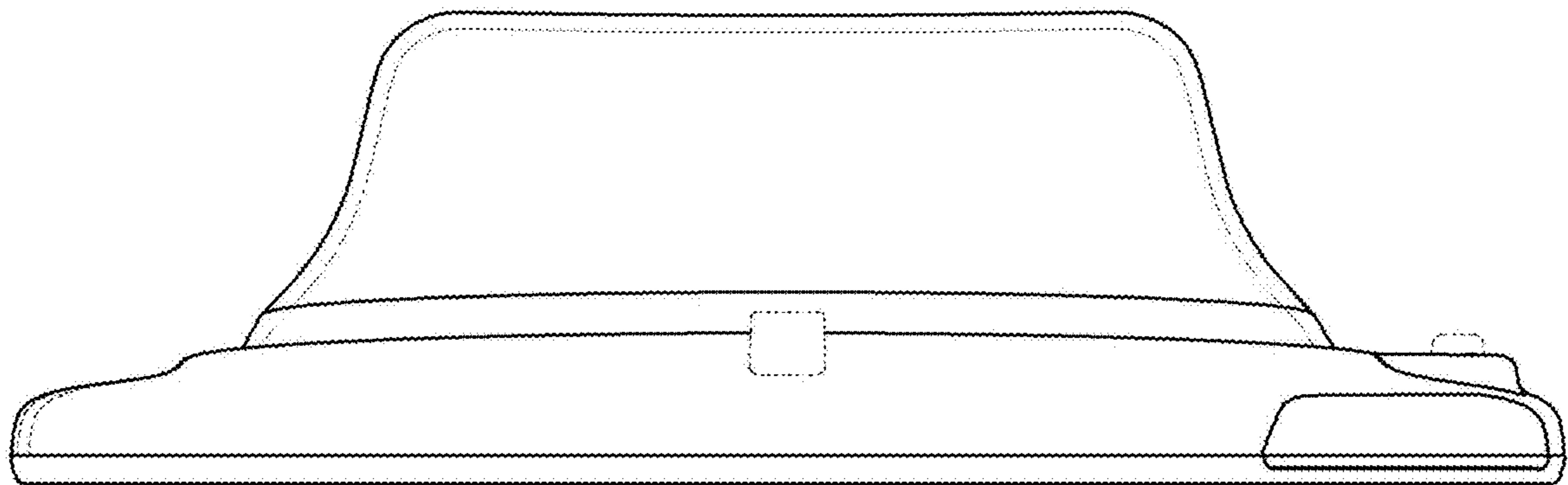

1.8

