



US00D919892S

(12) **United States Design Patent** (10) **Patent No.:** **US D919,892 S**
Pascalie (45) **Date of Patent:** **** May 18, 2021**

(54) **COMPACT FOR COSMETIC**

(56) **References Cited**

(71) Applicant: **L'OREAL**, Paris (FR)

U.S. PATENT DOCUMENTS

(72) Inventor: **Olivier Pascalie**, Asnieres (FR)

D302,745 S * 8/1989 Bakic D28/83

D535,442 S * 1/2007 Ditrichstein D28/78

D599,953 S * 9/2009 Gibson D27/190

D756,567 S * 5/2016 Pires D28/84

D835,350 S * 12/2018 Weinrich D28/83

D845,551 S * 4/2019 Weinrich D28/83

D853,036 S * 7/2019 Lee D28/82

D861,991 S * 10/2019 Liston D28/83

2003/0205236 A1* 11/2003 Lin A45D 33/24
132/293

(**) Term: **15 Years**

(21) Appl. No.: **35/509,162**

(22) Filed: **Jan. 10, 2020**

(80) **Hague Agreement Data**

Int. Filing Date: **Jan. 10, 2020**

Int. Reg. No.: **DM/207220**

Int. Reg. Date: **Jan. 10, 2020**

Int. Reg. Pub. Date: **Apr. 24, 2020**

* cited by examiner

Primary Examiner — Michael A. Pratt

(51) **LOC (13) Cl.** **28-03**

(57) **CLAIM**

The ornamental design for a compact for cosmetic, as shown and described.

(52) **U.S. Cl.**

DESCRIPTION

USPC **D28/82**

(58) **Field of Classification Search**

USPC D28/64.1, 76-84; D9/503-505, 722, 529,
D9/420, 425, 428, 454; D11/204, 217;
D19/103-106; D3/295

CPC A45D 33/006; A45D 33/003; A45D
33/0433; A45D 33/025; A45D 33/02;
A45D 33/20; A45D 33/22; A45D 33/24;
A45D 33/26; A45D 33/28; A45D 33/18;
A45D 40/22; A45D 40/222; A45D 40/24;
A45D 2200/051-053; A45D
2040/223-228

- 1. Compact for cosmetic
- 1.1 : Back
- 1.2 : Bottom
- 1.3 : Front
- 1.4 : Intermediate open view
- 1.5 : Left
- 1.6 : Open view
- 1.7 : Perspective
- 1.8 : Right
- 1.9 : Top

A compact for cosmetic.

See application file for complete search history.

1 Claim, 9 Drawing Sheets

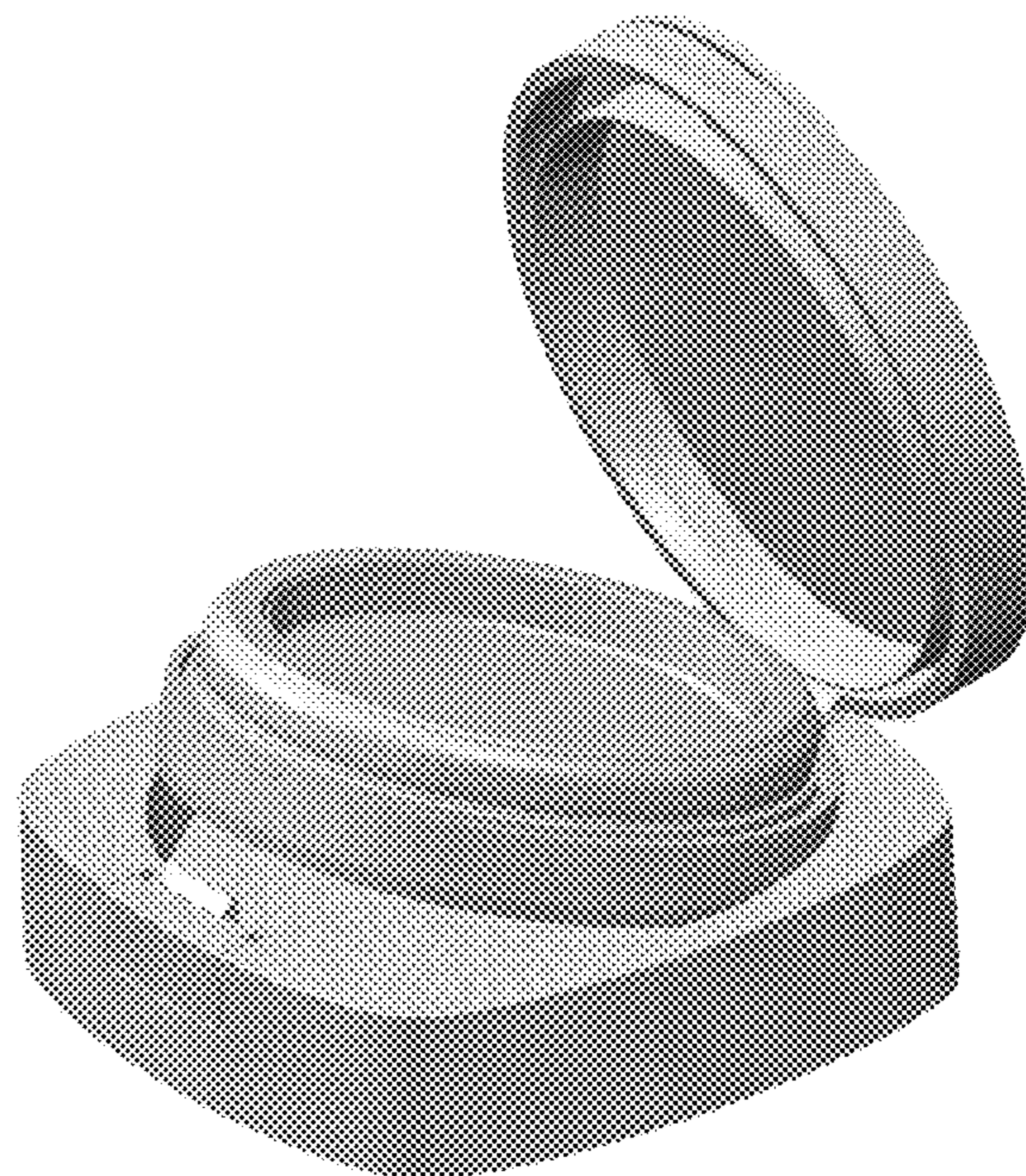
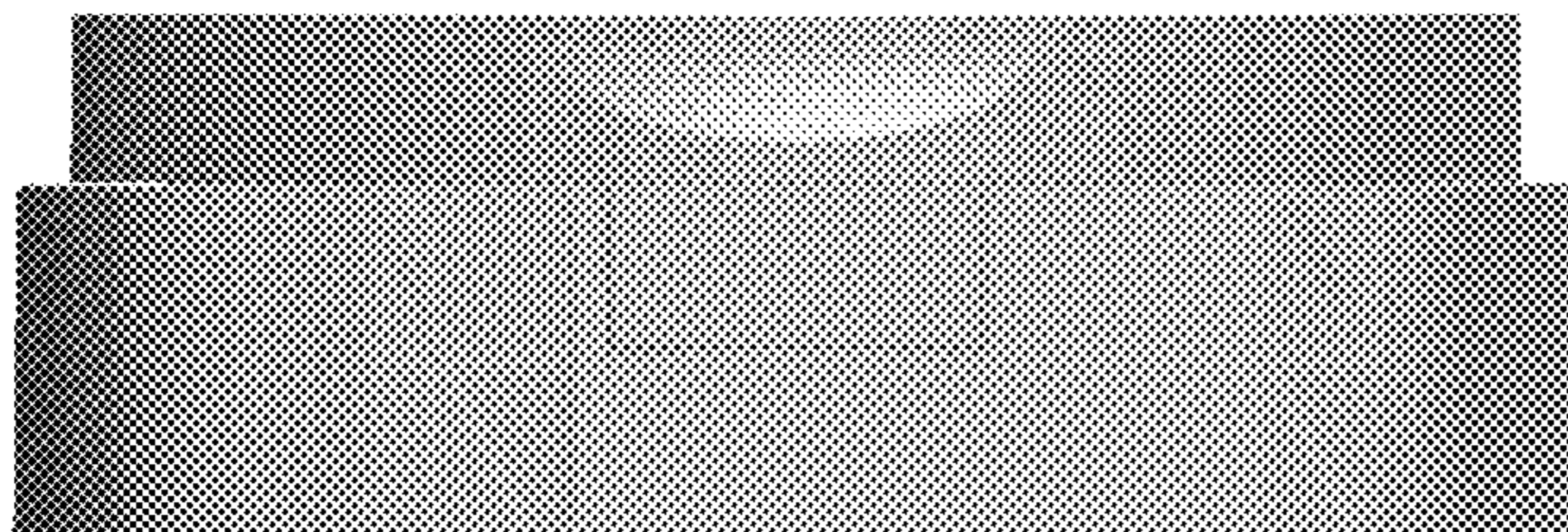

1.1

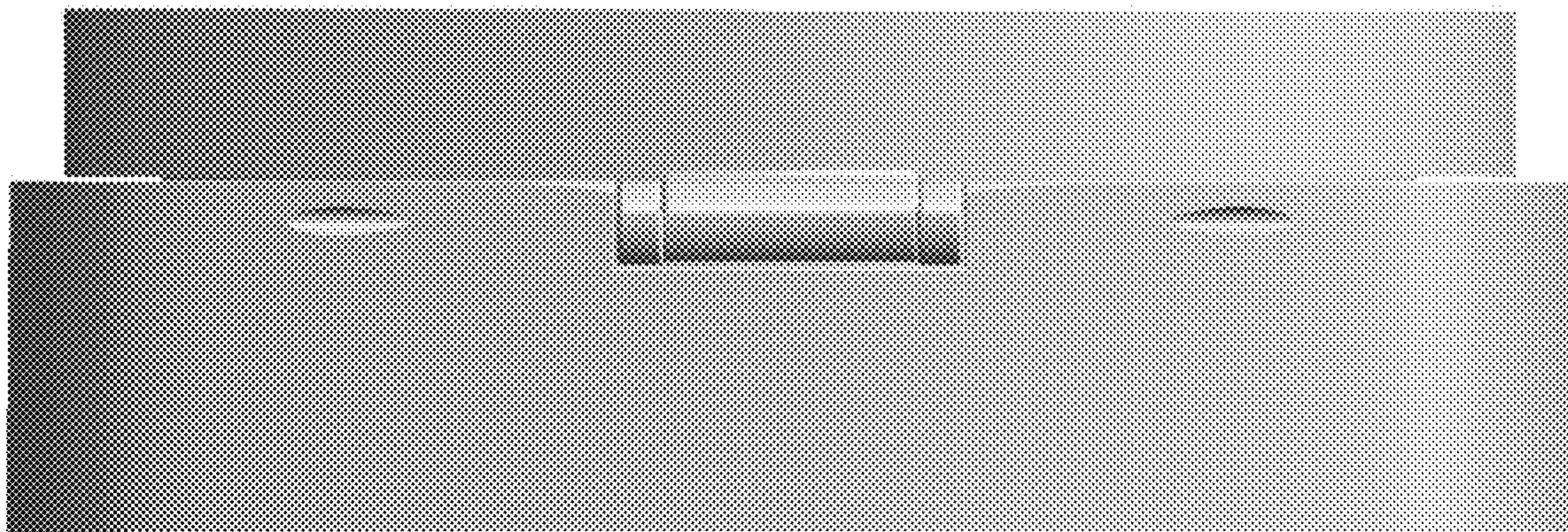

1.2

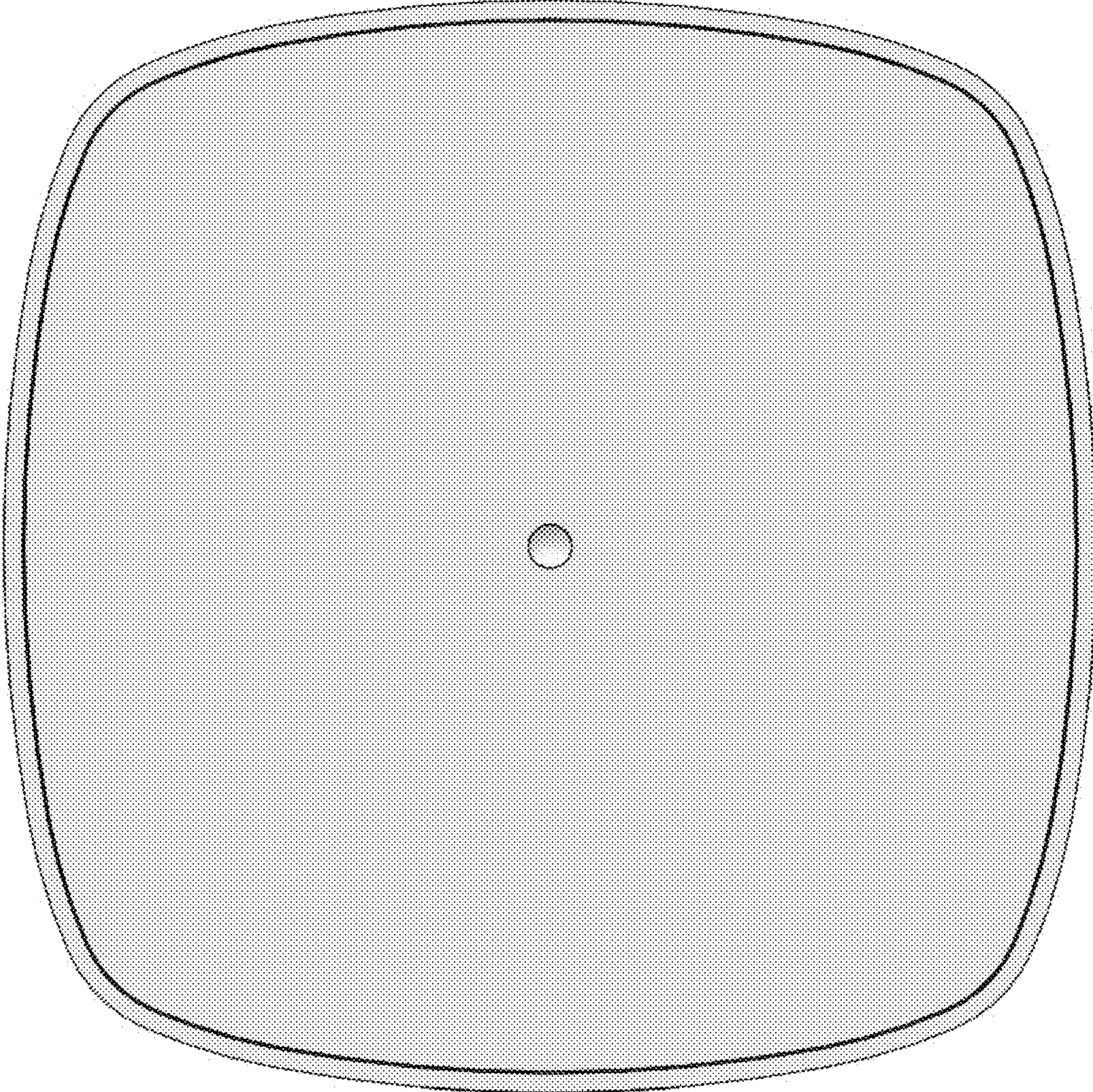

1.3

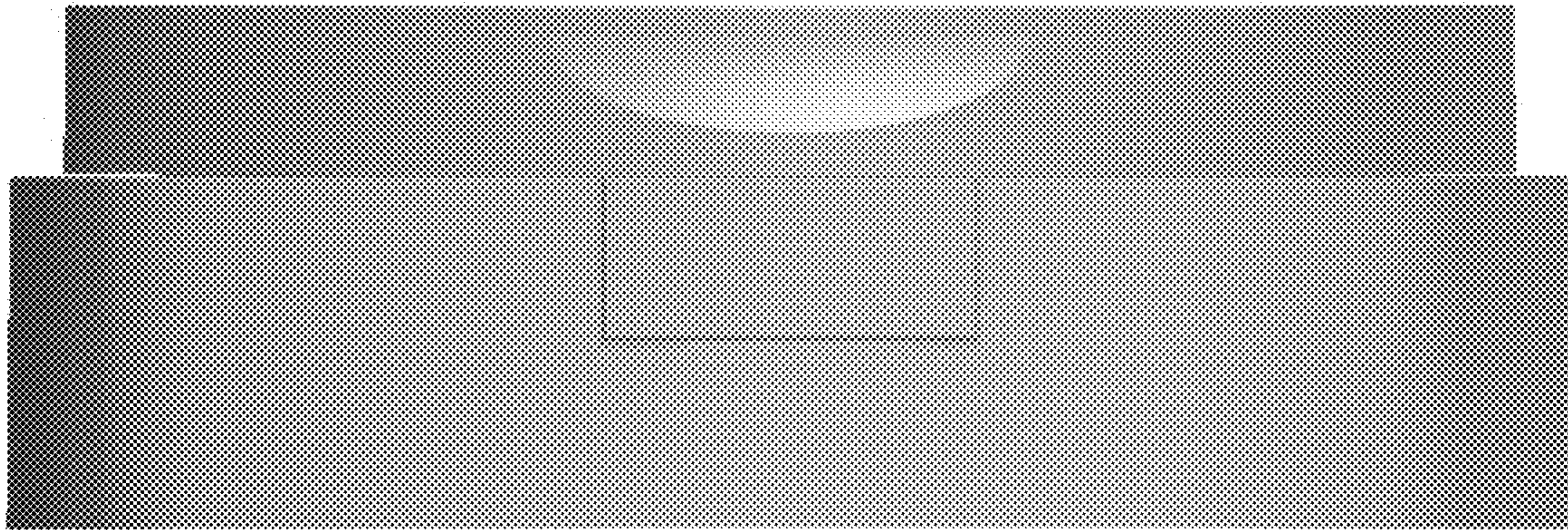

1.4

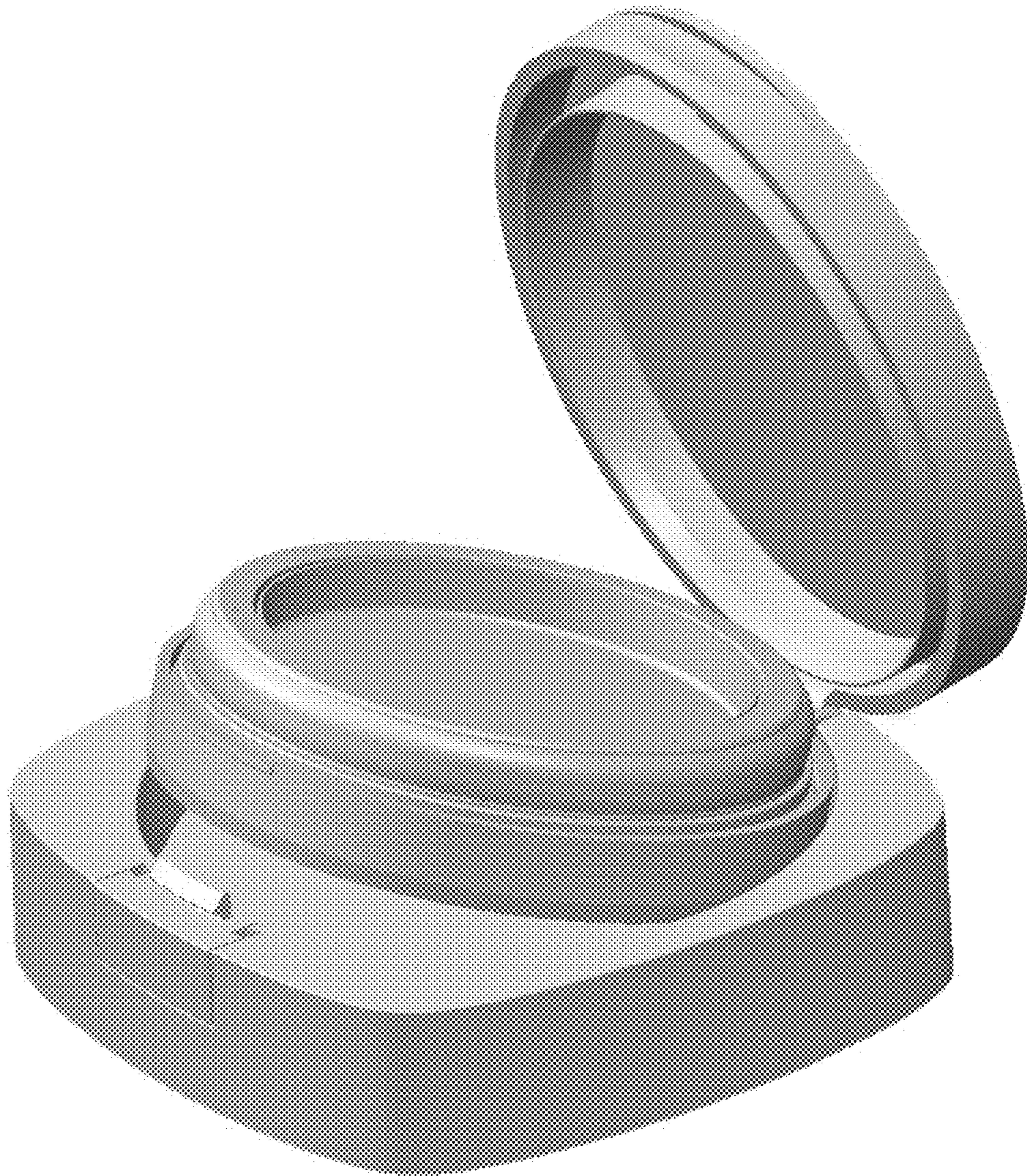

1.5

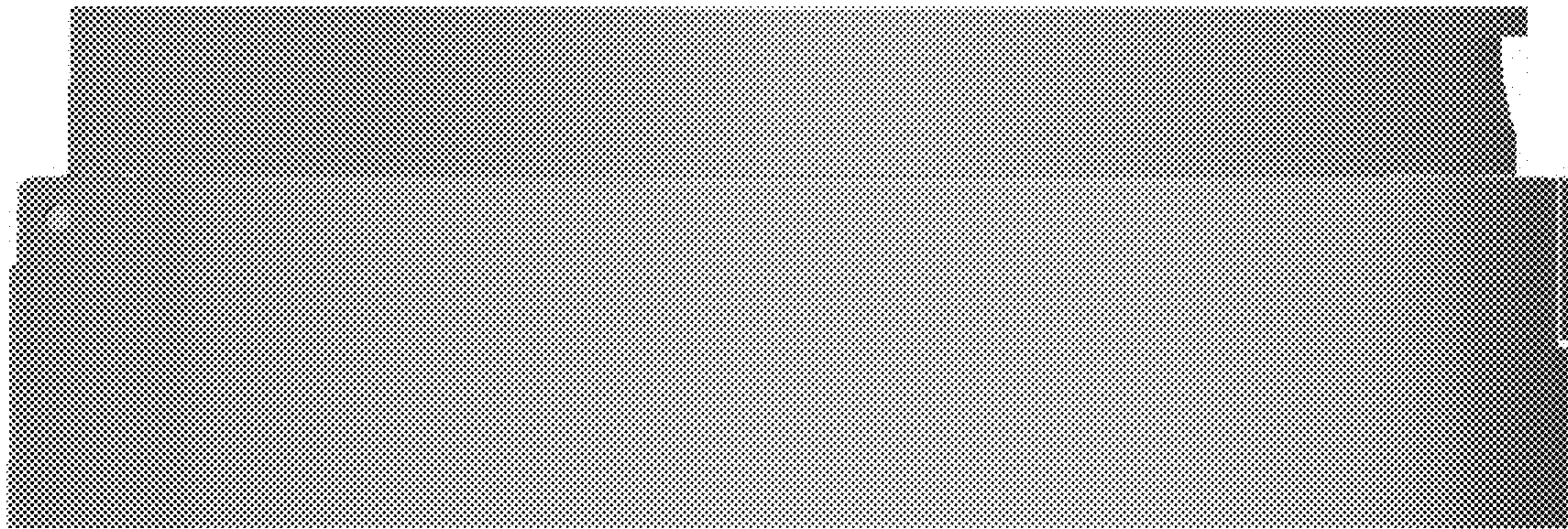

1.6

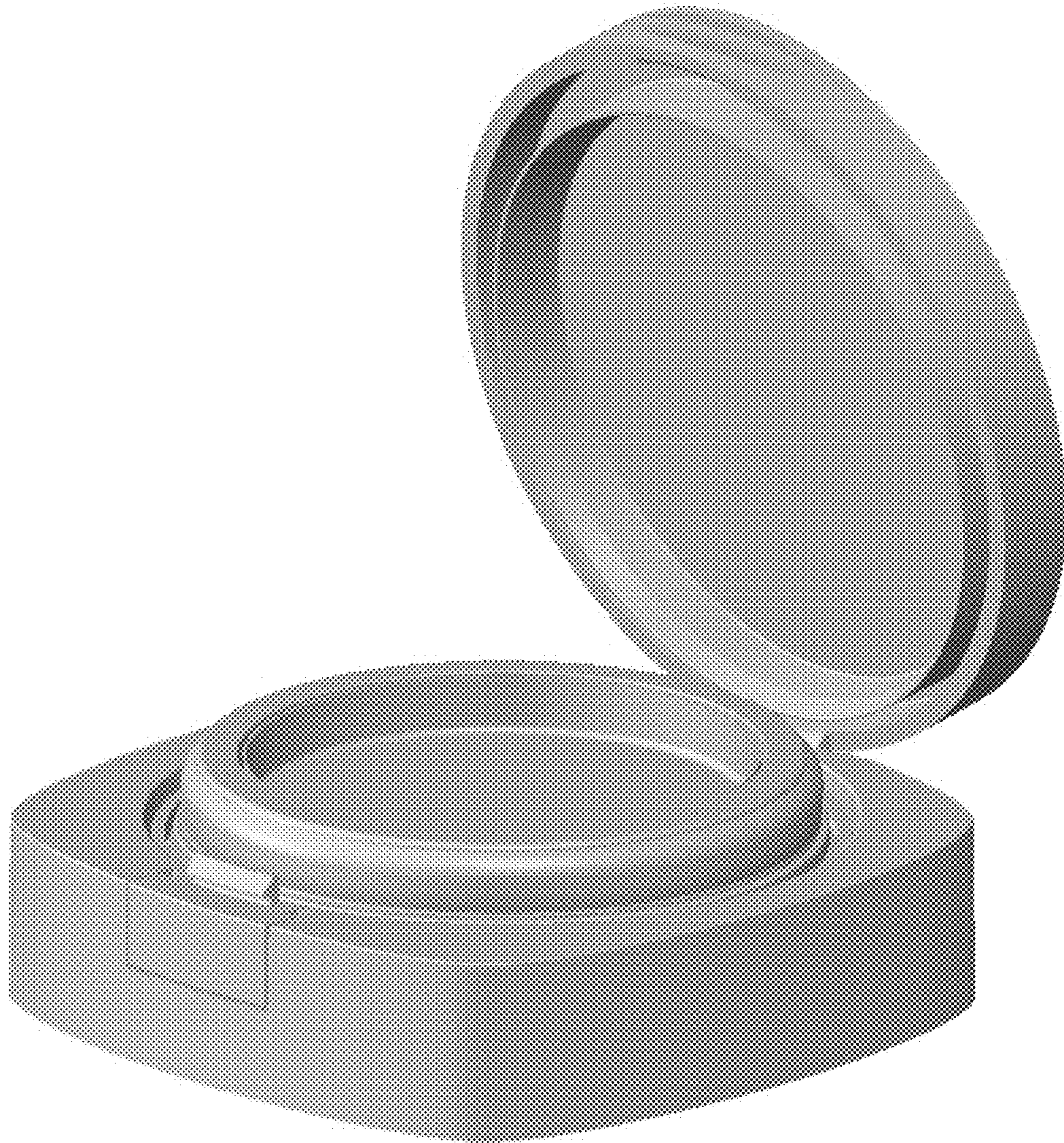

1.7

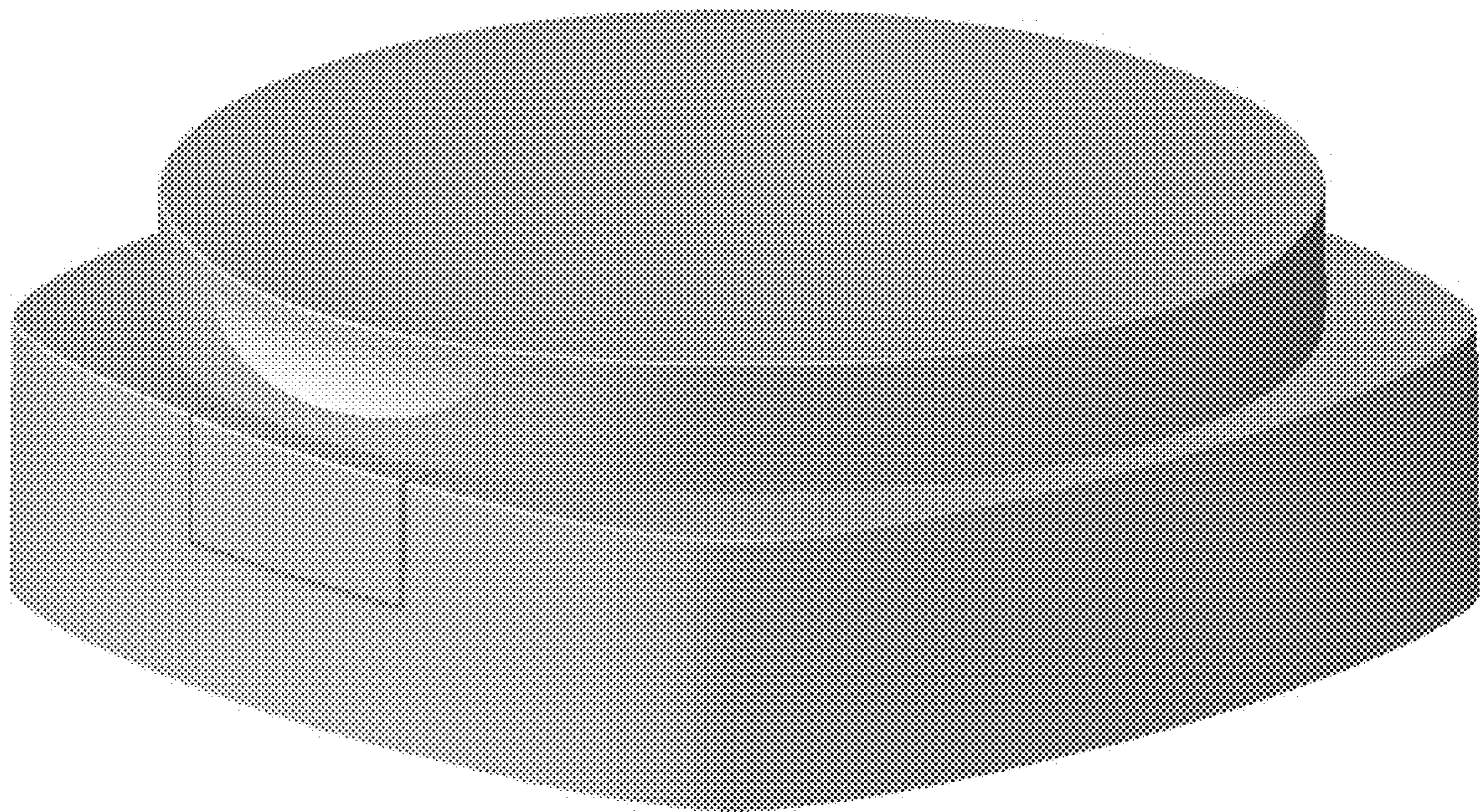

1.8

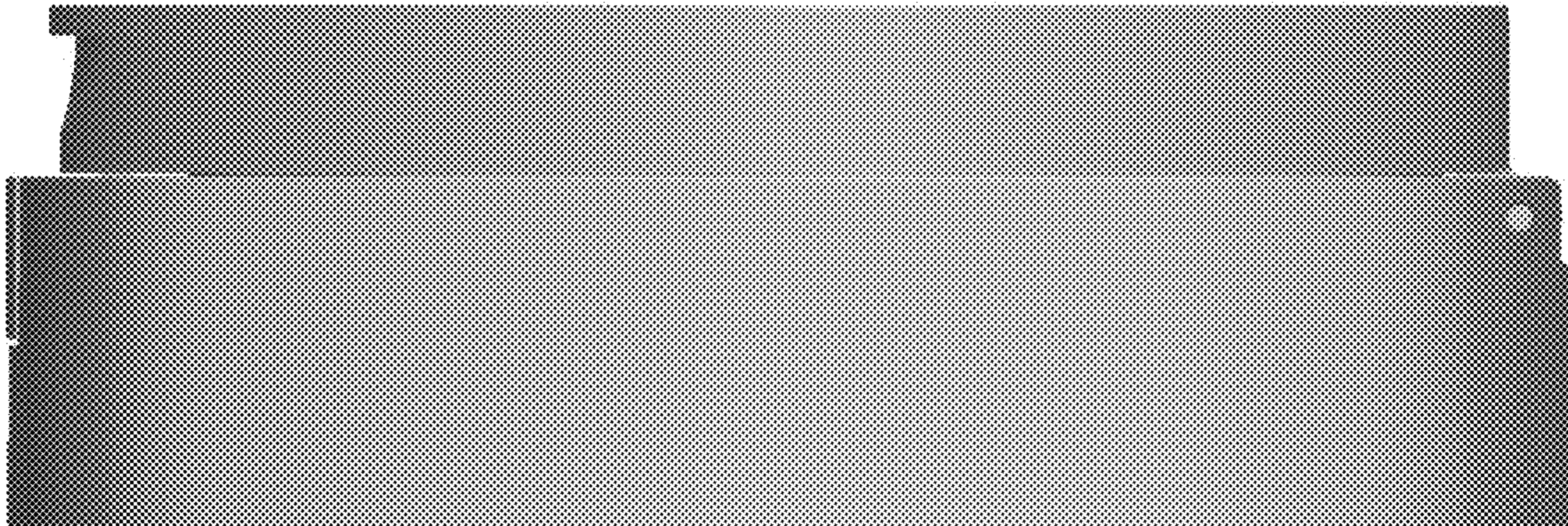

1.9

