



US00D919891S

(12) **United States Design Patent** (10) **Patent No.:** **US D919,891 S**  
**Huang** (45) **Date of Patent:** **\*\* May 18, 2021**

- (54) **MAKEUP CASE**
- (71) Applicant: **Shenzhen Hexin Electronics Co., Ltd.**,  
Shenzhen (CN)
- (72) Inventor: **Lianwu Huang**, Shenzhen (CN)
- (73) Assignee: **Shenzhen Hexin Electronics Co., Ltd.**,  
Shenzhen (CN)
- (\*\*) Term: **15 Years**
- (21) Appl. No.: **29/769,017**
- (22) Filed: **Feb. 2, 2021**
- (51) **LOC (13) Cl.** ..... **28-03**
- (52) **U.S. Cl.**  
USPC ..... **D28/82**; D28/73; D3/901
- (58) **Field of Classification Search**  
USPC ..... D28/73, 76-84; D9/430, 432, 428;  
D3/901, 284  
CPC .... A45D 33/00; A45D 33/003; A45D 33/006;  
A45D 33/008; A45D 33/18; A45D 33/20;  
A45D 33/22; A45D 33/24; A45D 33/26;  
A45D 33/28; A45D 40/00; A45D 40/22;  
A45D 40/24; A45D 2040/0012  
See application file for complete search history.

- 2016/0143413 A1\* 5/2016 Pourmehr ..... A45D 40/24  
132/314
- 2017/0035184 A1\* 2/2017 Sagel ..... A45D 33/006
- 2017/0112261 A1\* 4/2017 Grund ..... A45D 40/222
- 2020/0146408 A1\* 5/2020 Porras ..... A46B 5/0095

**OTHER PUBLICATIONS**

Sparkle & Shine Unicorn Train Case, www.lipsmaker.com, 1 page, downloaded Mar. 1, 2021 (Year: 2021).\*

Cameo 9879 Heart Shaped Case, www.amazon.in, 1 page, downloaded Mar. 1, 2021 (Year: 2021).\*

Kids makeup cosmetics, www.ChinaSuppliers.com, 1 page, downloaded Mar. 1, 2021 (Year: 2021).\*

\* cited by examiner

*Primary Examiner* — Jennifer Rivard  
(74) *Attorney, Agent, or Firm* — ScienBiziP, P.C.

(57) **CLAIM**

The ornamental design for a makeup case, as shown and described.

**DESCRIPTION**

FIG. 1 is a front, right, and top perspective view of a makeup case, showing my design.

FIG. 2 is a rear, left, and bottom perspective view thereof.

FIG. 3 is a front elevation view thereof.

FIG. 4 is a rear elevation view thereof.

FIG. 5 is a left side elevation view thereof.

FIG. 6 is a right side elevation view thereof.

FIG. 7 is a top plan view thereof.

FIG. 8 is a bottom plan view of the makeup case wherein a left side tray and a right side tray are slid into the makeup case; and,

FIG. 9 is a front, right, and top perspective view of the makeup case in a closed state.

The broken lines shown in the drawings are included for the purpose of illustrating portions of the makeup case that form no part of the claimed design.

(56) **References Cited**

**U.S. PATENT DOCUMENTS**

- D444,596 S \* 7/2001 Lai ..... D28/82
- D479,895 S \* 9/2003 Lai ..... D28/83
- D480,180 S \* 9/2003 Lai ..... D28/83
- D718,499 S \* 11/2014 Pourmehr ..... D28/83
- D752,290 S \* 3/2016 Beilman ..... D28/73
- D757,434 S \* 5/2016 Beilman ..... D3/284
- D901,294 S 11/2020 McGrath
- D903,500 S 12/2020 McGrath
- 2004/0163971 A1\* 8/2004 Lin ..... B65D 77/26  
206/38
- 2009/0255846 A1\* 10/2009 Pires ..... A45D 40/24  
206/581

**1 Claim, 9 Drawing Sheets**

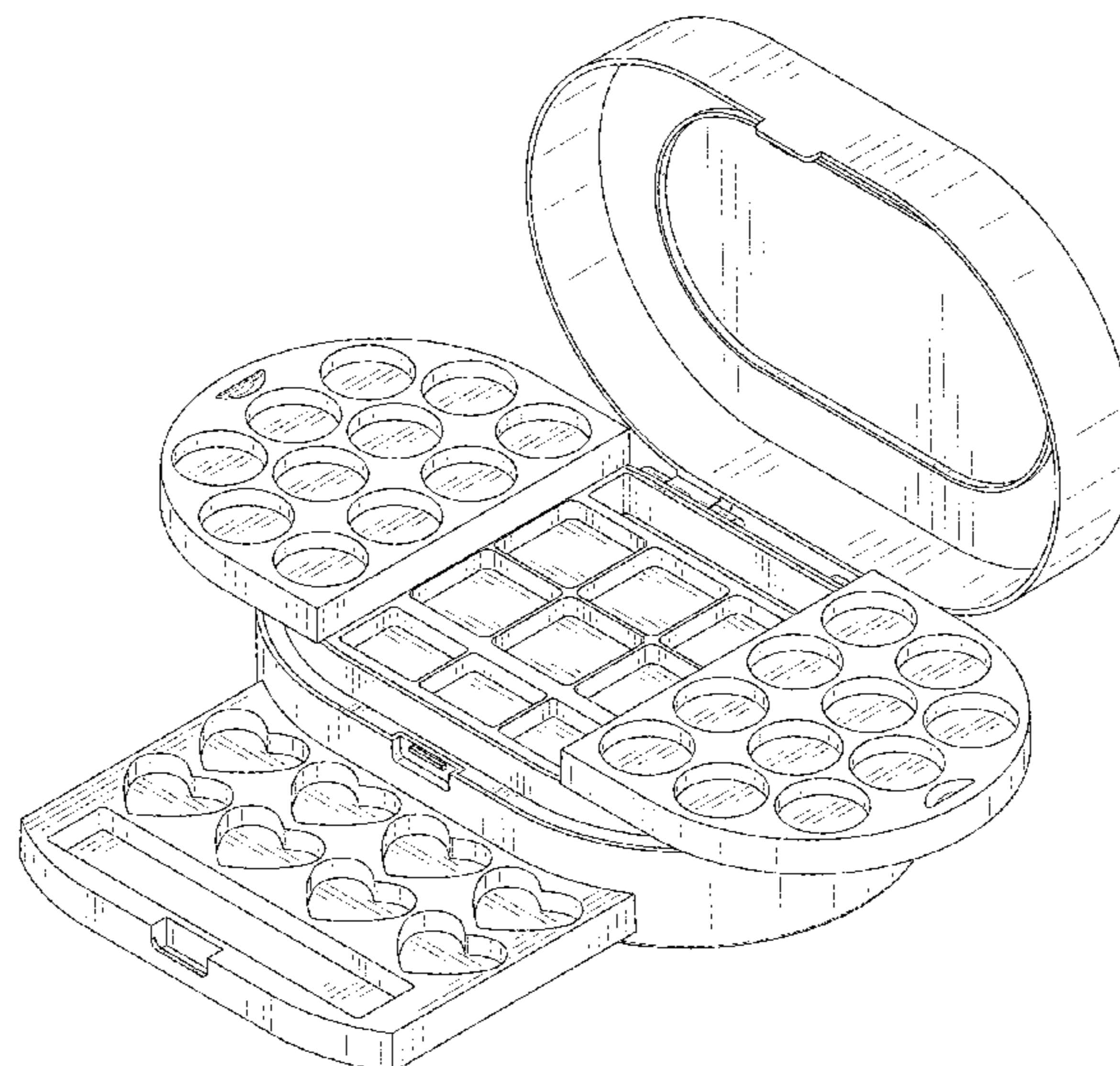

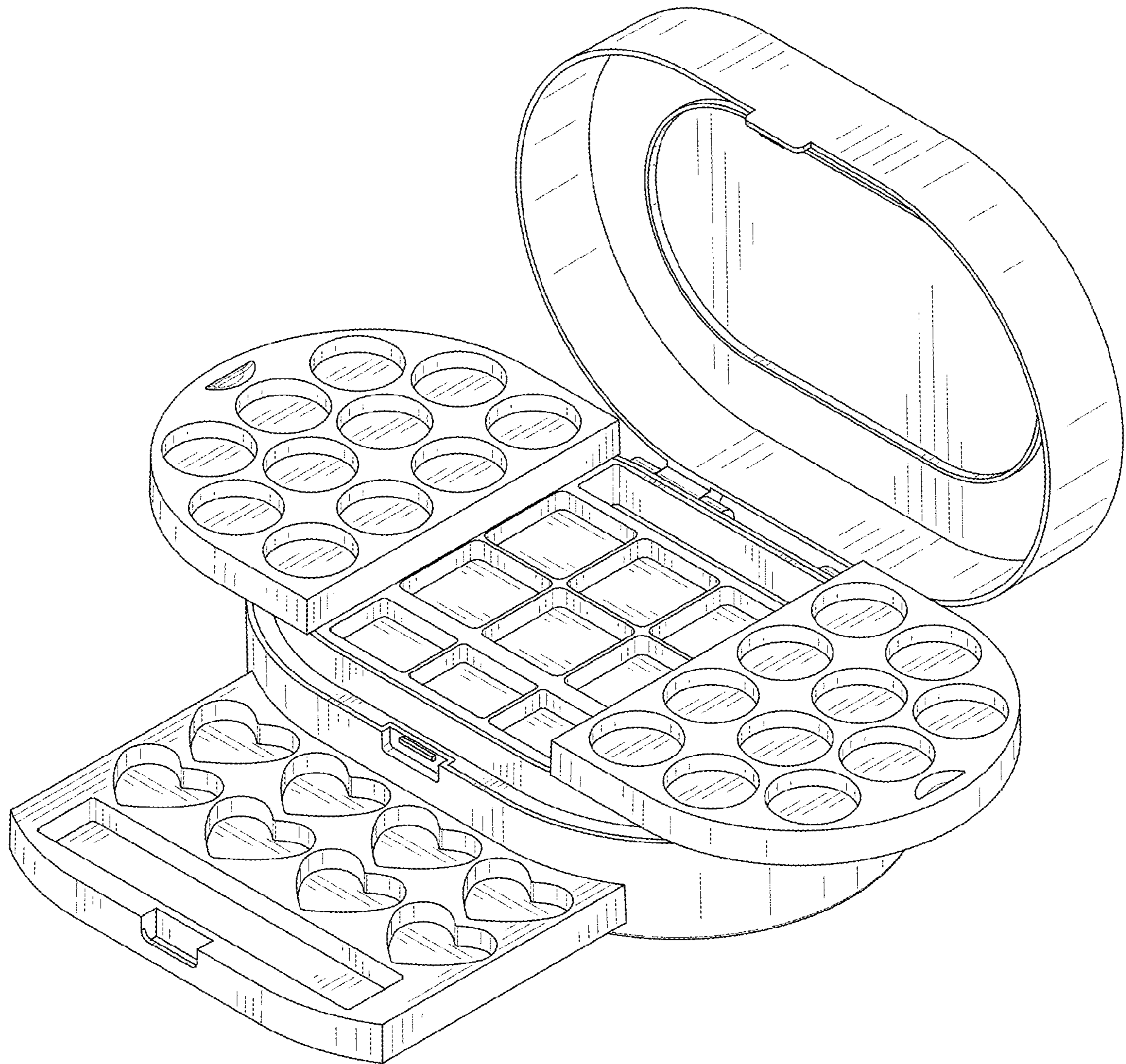

FIG. 1



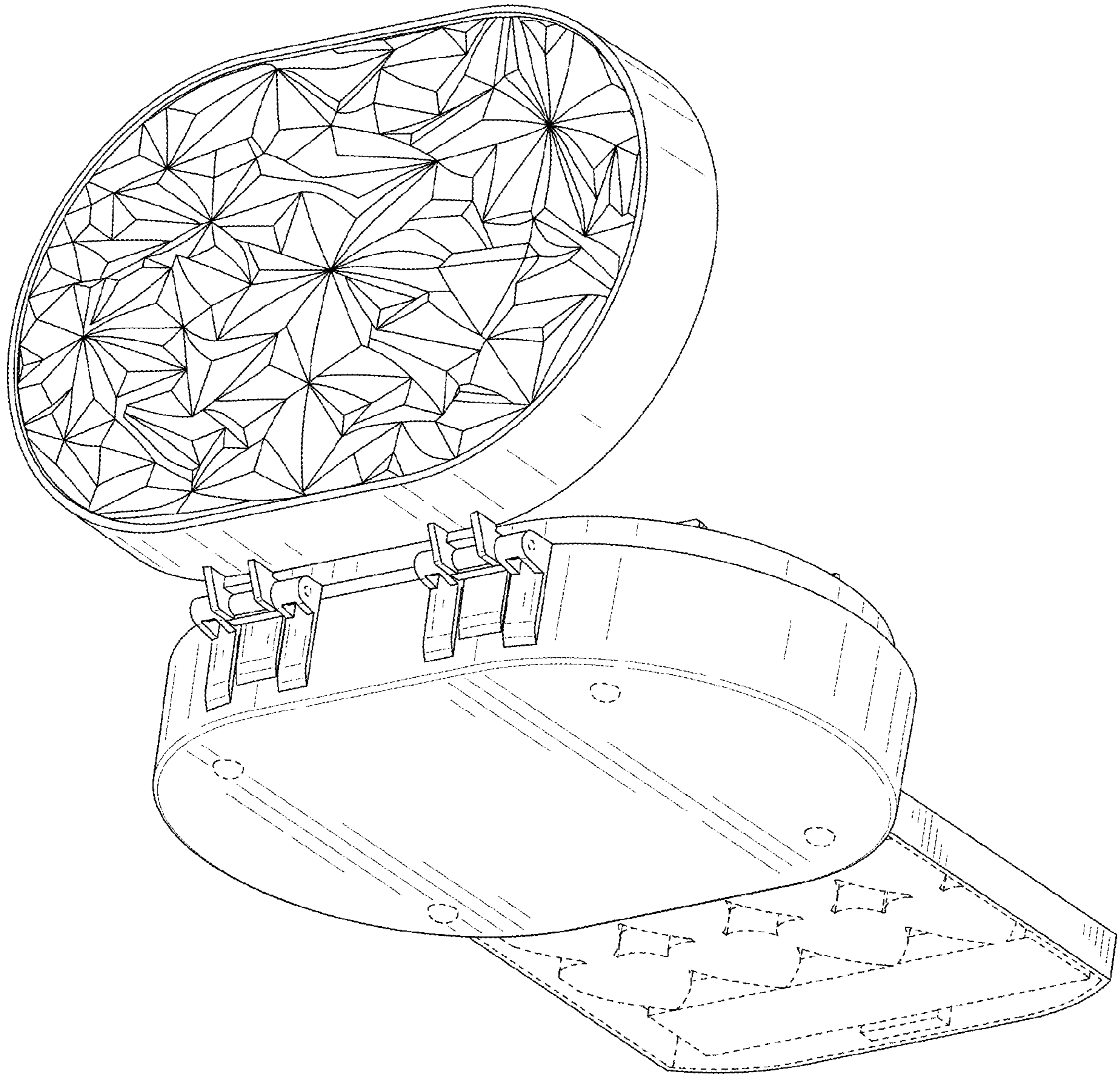

FIG. 2

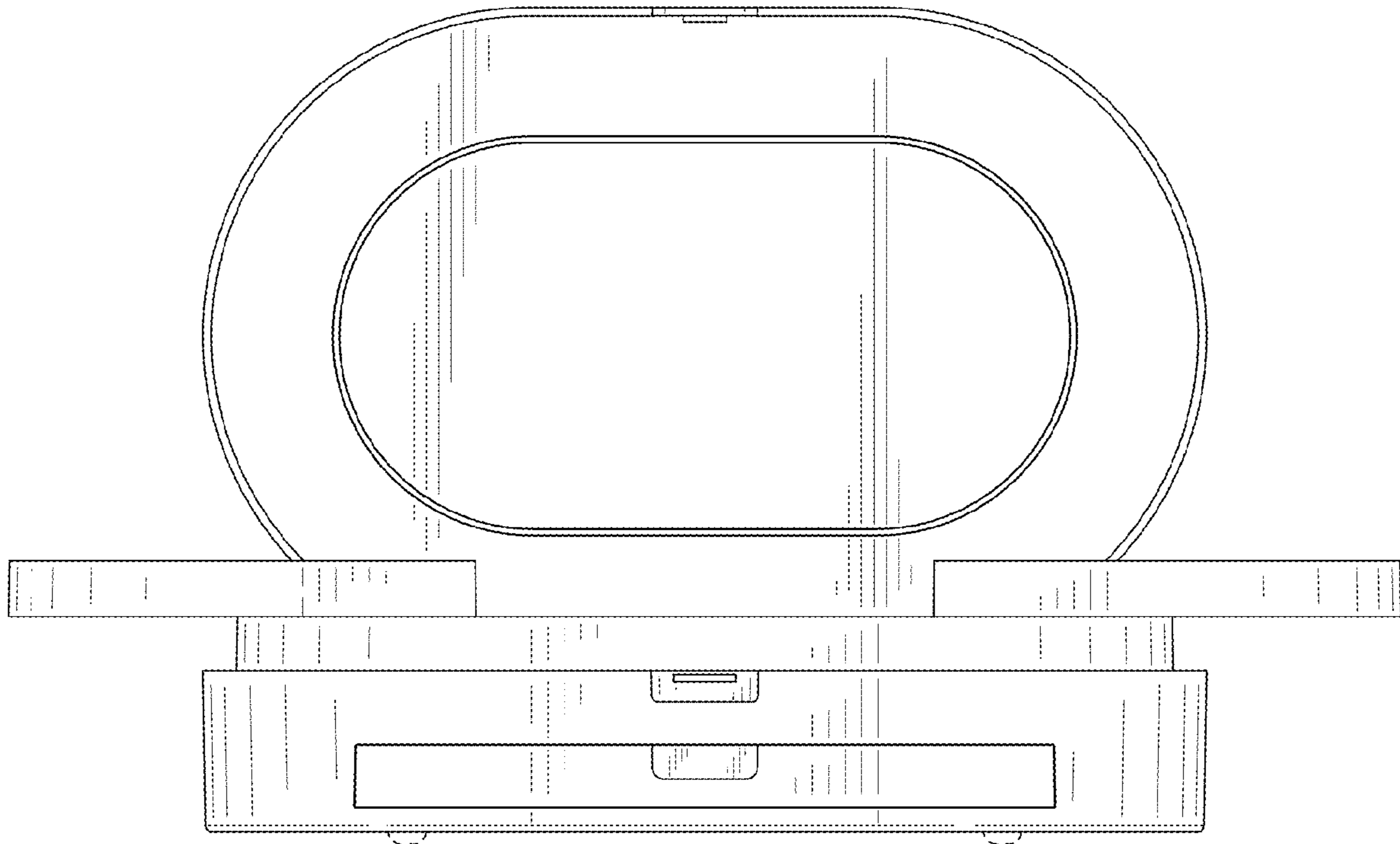

FIG. 3

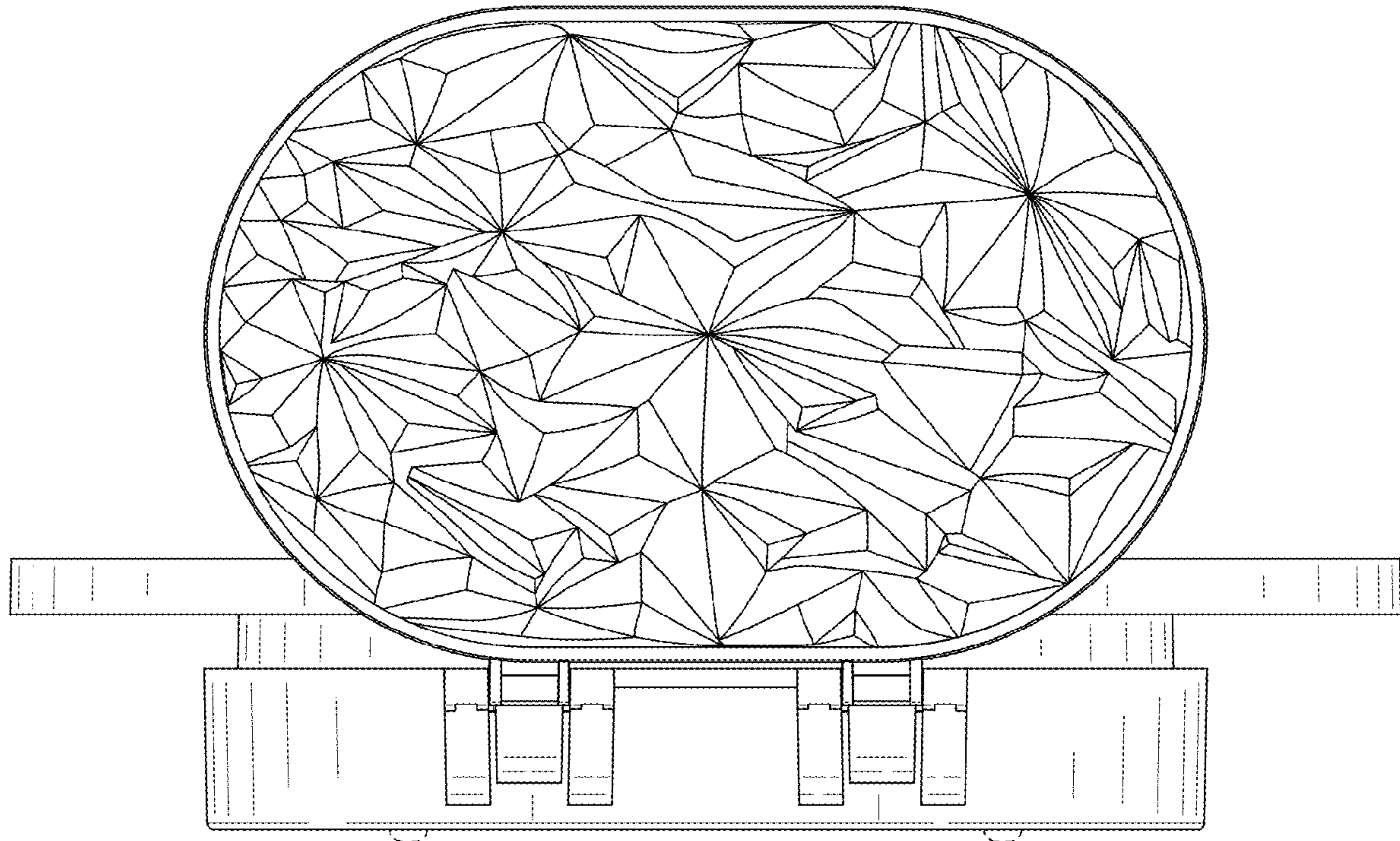

FIG. 4

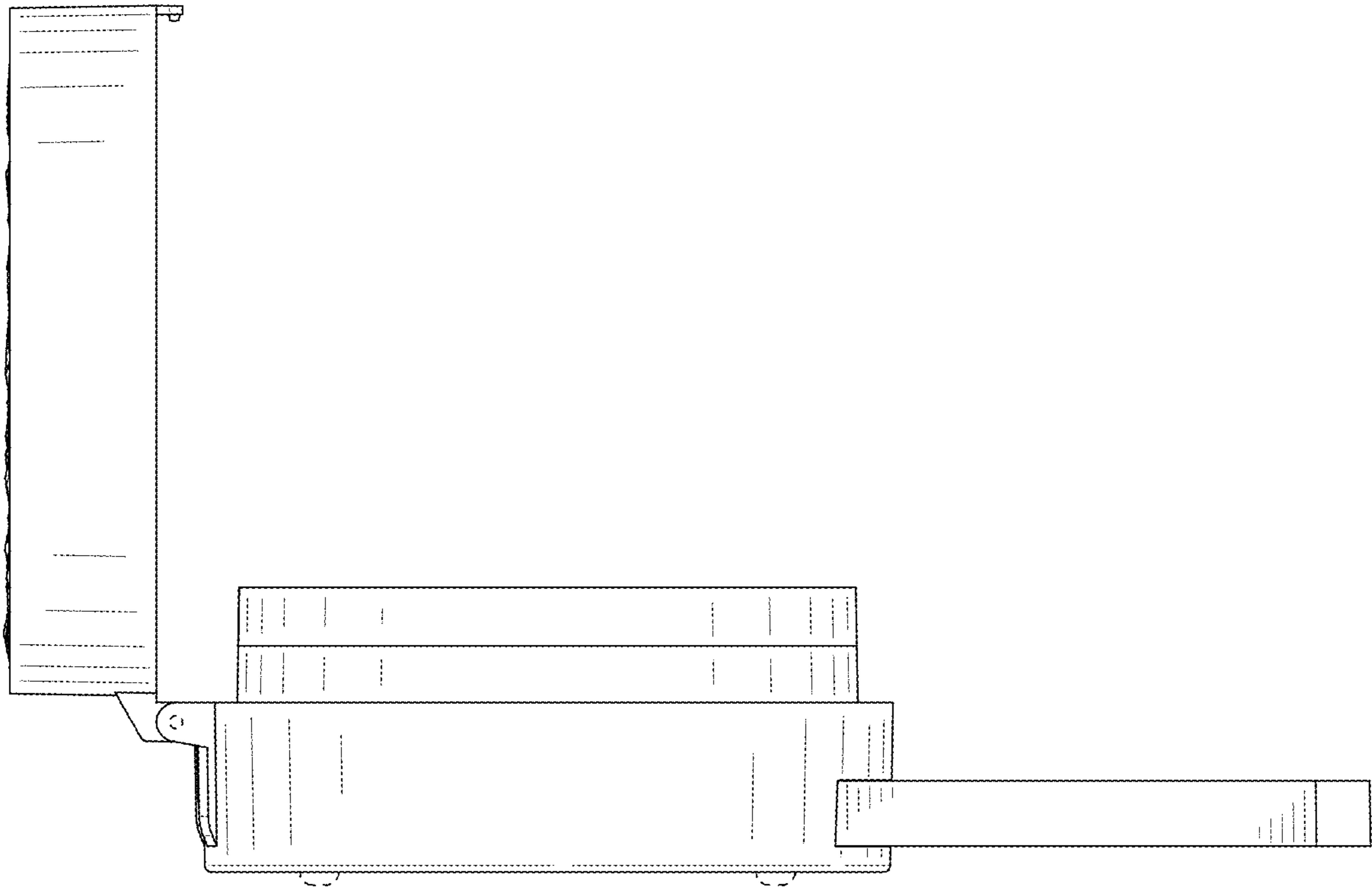

FIG. 5

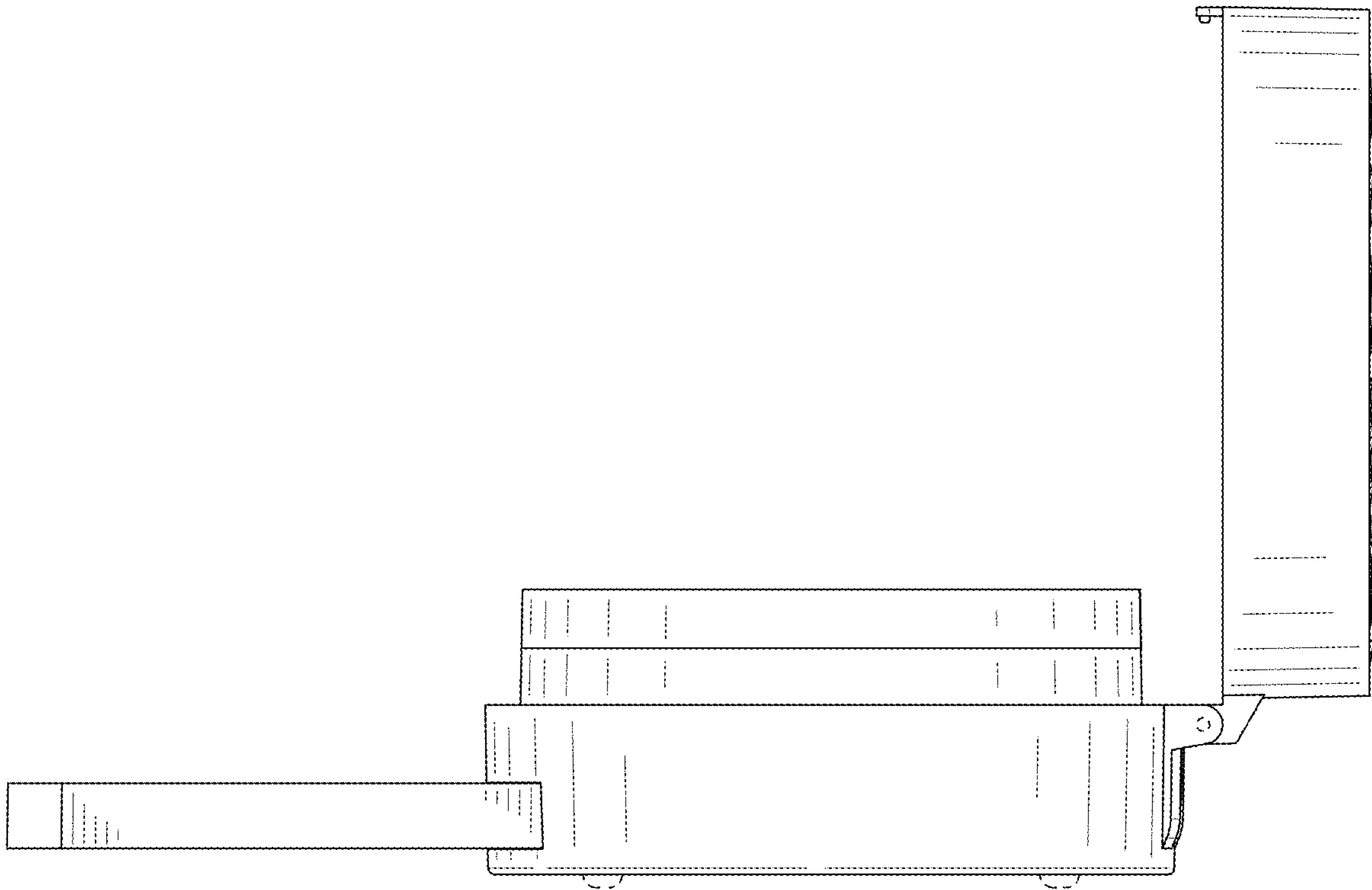

FIG. 6



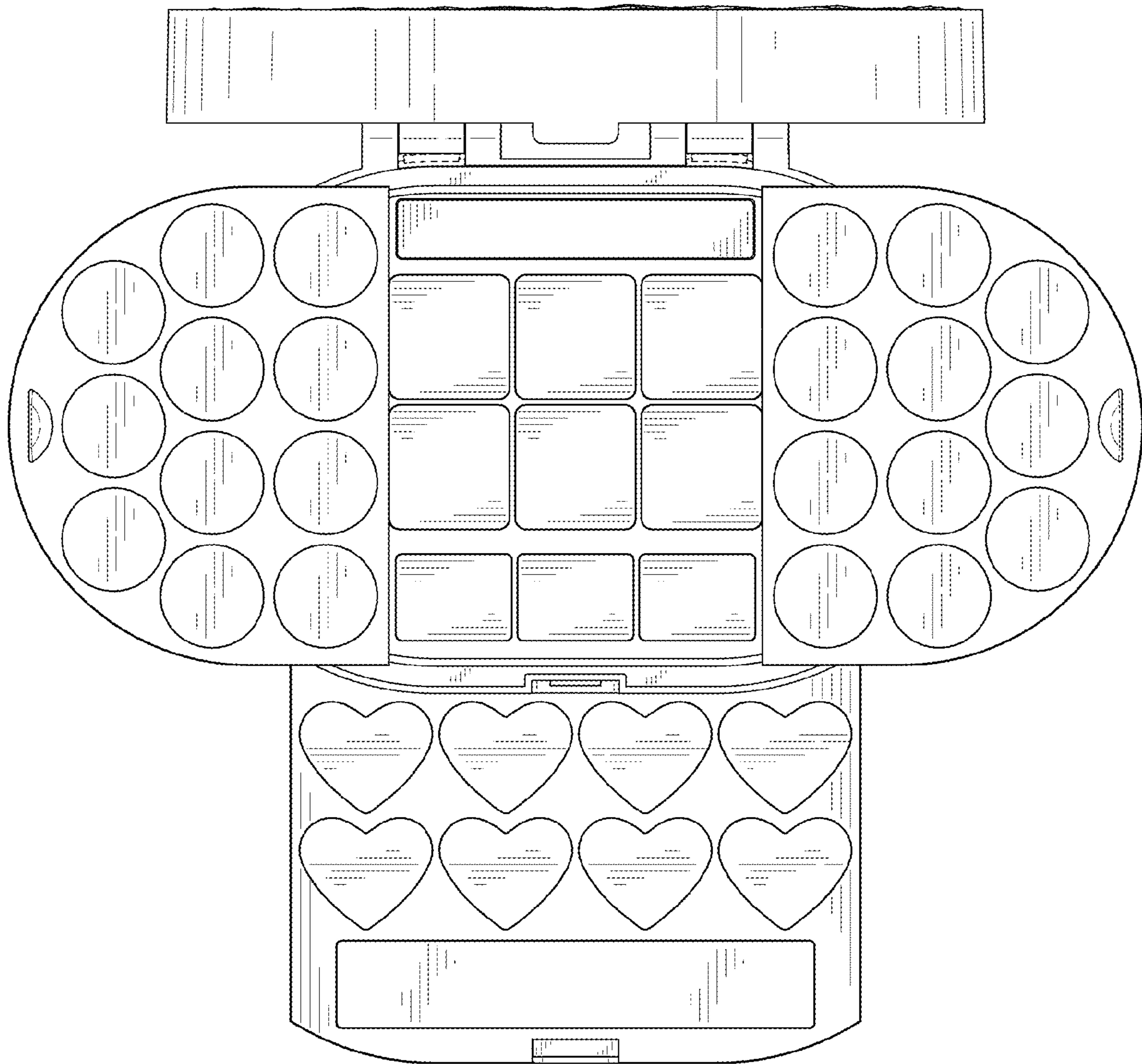

FIG. 7



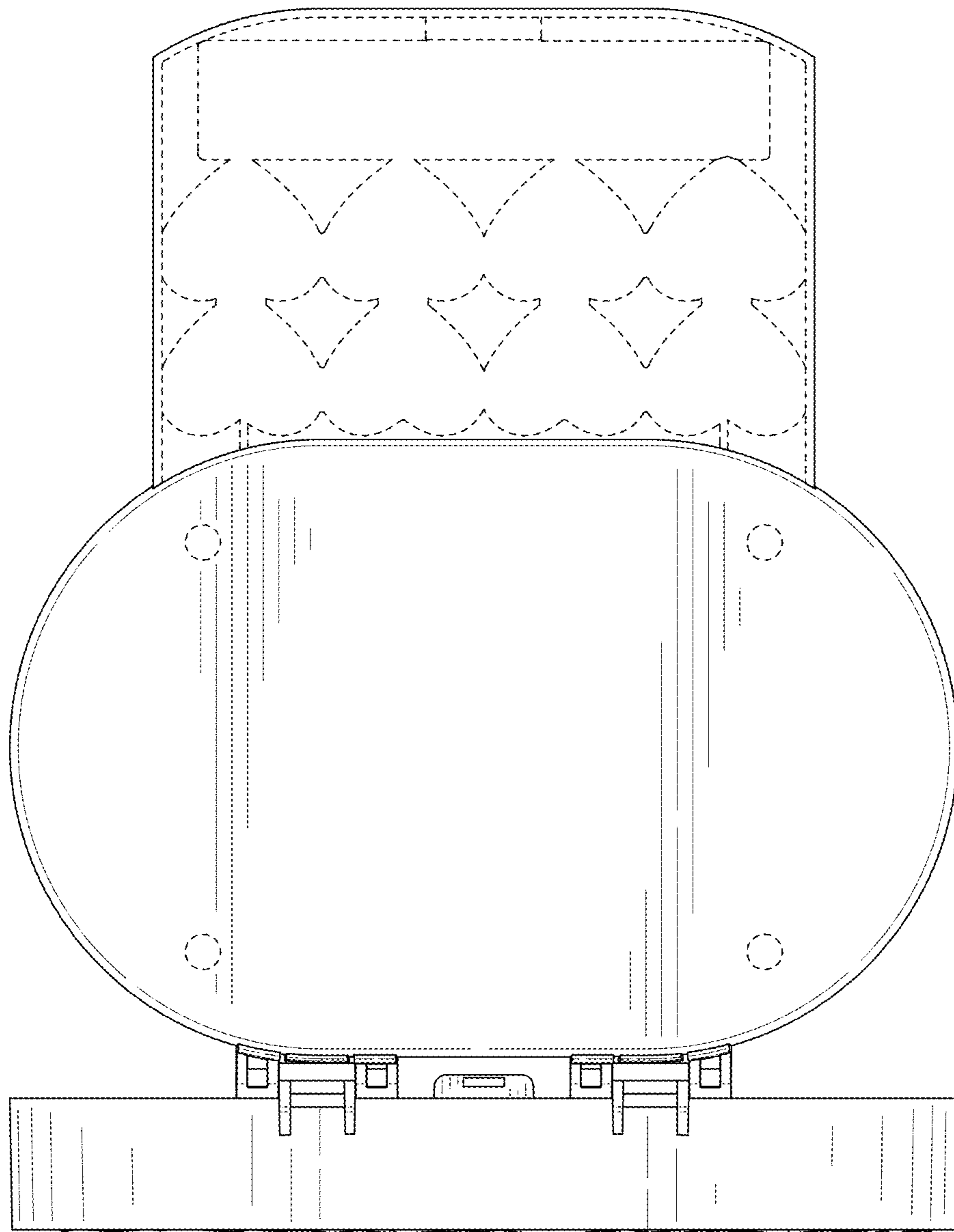

FIG. 8

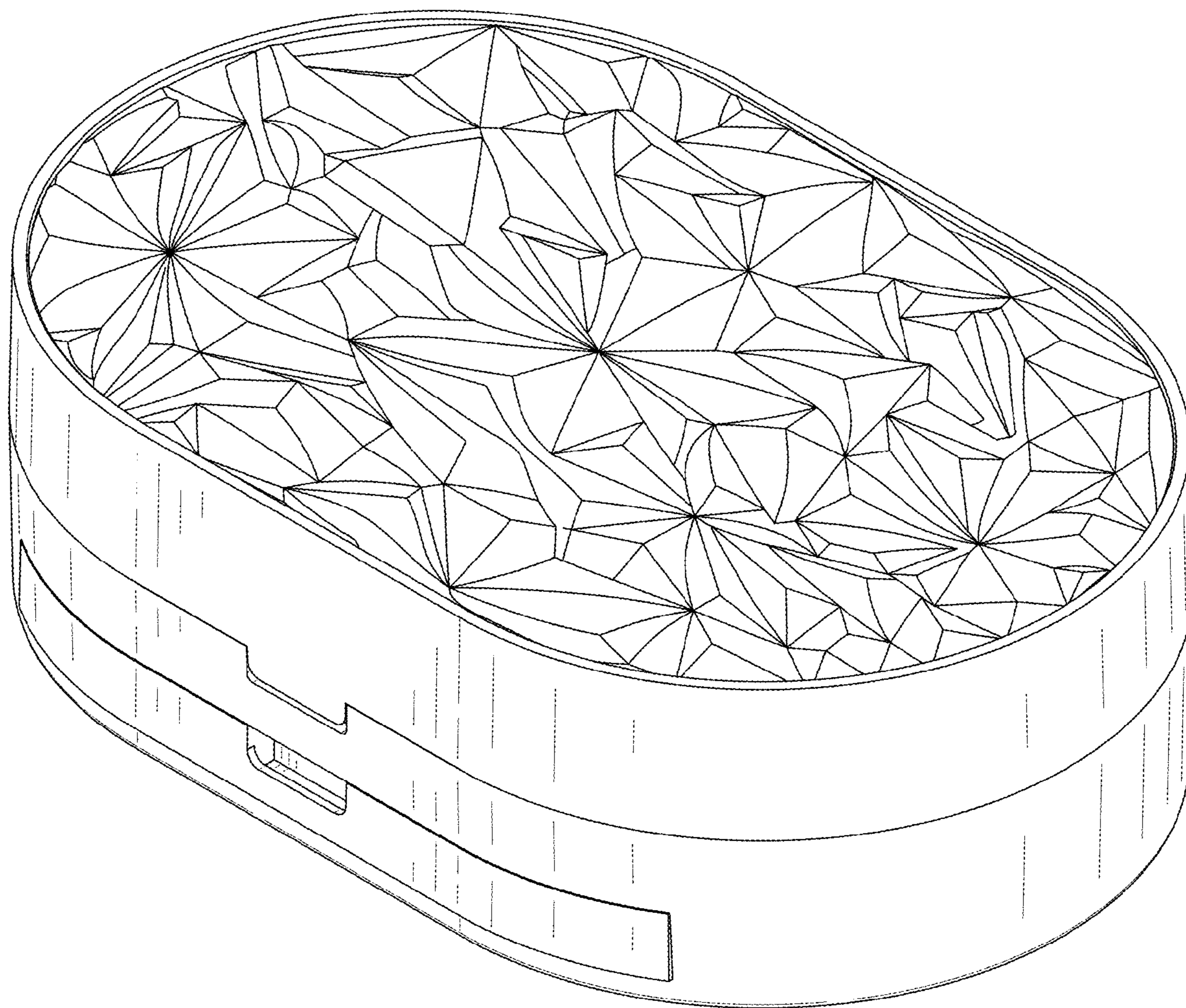

FIG. 9