



US00D919889S

(12) **United States Design Patent** (10) **Patent No.:** **US D919,889 S**
Park (45) **Date of Patent:** **** May 18, 2021**

(54) **TOENAIL CLIPPER**

FOREIGN PATENT DOCUMENTS

(71) Applicant: **Arda Inc.**, Goyang-si (KR)

JP D1656498 * 7/2019

(72) Inventor: **Seong Hun Park**, Goyang-si (KR)

OTHER PUBLICATIONS

(73) Assignee: **Arda Inc.**, Goyang-si (KR)

(**) Term: **15 Years**

L Shape Nailclippers, announced 2018 [online], [site visited Sep. 23, 2020]. Available from internet, URL:<https://ifworlddesignguide.com/entry/255208-l-shape-nailclippers> (Year: 2018).*

(21) Appl. No.: **29/701,755**

Three Seven N-251A [online], [site visited Sep. 23, 2020]. Available from internet, URL:<http://www.i777shop.com/shop/step1.php?number=68&b_code=B20101210071108&c_code=C20101210071805> (Year: 2020).*

(22) Filed: **Aug. 14, 2019**

(30) **Foreign Application Priority Data**

* cited by examiner

Jul. 22, 2019 (KR) 30-2019-0035108

(51) **LOC (13) Cl.** **28-03**

Primary Examiner — Cynthia Ramirez

(52) **U.S. Cl.**
USPC **D28/60**

Assistant Examiner — Xavier Marti-Santos

(58) **Field of Classification Search**
USPC D28/55–62, 99
CPC A45D 29/00; A45D 44/00; A45D 29/18;
A45D 29/02; A45D 29/023; A45D
2029/026; A41G 5/02
See application file for complete search history.

(74) *Attorney, Agent, or Firm* — Jefferson IP Law, LLP

(56) **References Cited**

(57) **CLAIM**

U.S. PATENT DOCUMENTS

The ornamental design for a toenail clipper, as shown and described.

DESCRIPTION

D286,091 S * 10/1986 Hill D24/147
D448,523 S * 9/2001 Kramer D28/60
D516,249 S * 2/2006 Merheje D28/60
D547,006 S * 7/2007 Han D28/60
D629,566 S * 12/2010 Vicari D28/60
D676,609 S * 2/2013 Kim D28/60
2003/0010349 A1 * 1/2003 Rende A45D 29/023
132/75
2007/0067995 A1 * 3/2007 Alfaro A45D 29/02
30/28
2014/0196291 A1 * 7/2014 Fernandez Quintero
A45D 29/023
30/26

FIG. 1 is a perspective view of a toenail clipper, showing my new design;
FIG. 2 is a front elevational view thereof;
FIG. 3 is a rear elevational view thereof;
FIG. 4 is a left side elevational view thereof;
FIG. 5 is a right side elevational view thereof;
FIG. 6 is a top plan view thereof;
FIG. 7 is a bottom plan view thereof;
FIG. 8 is a rear perspective view thereof; and,
FIG. 9 is a exploded perspective view thereof.

1 Claim, 9 Drawing Sheets

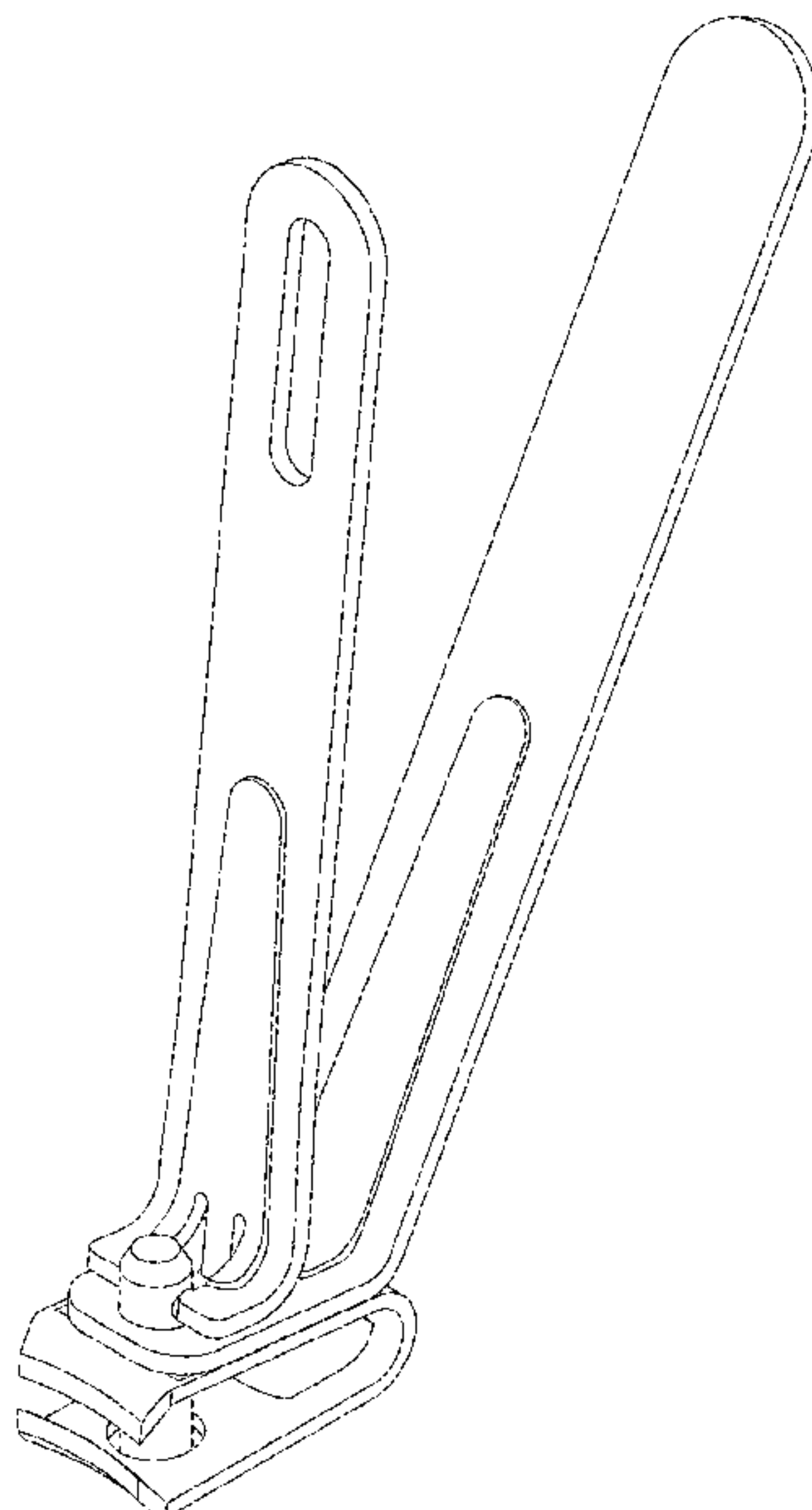

FIG. 1

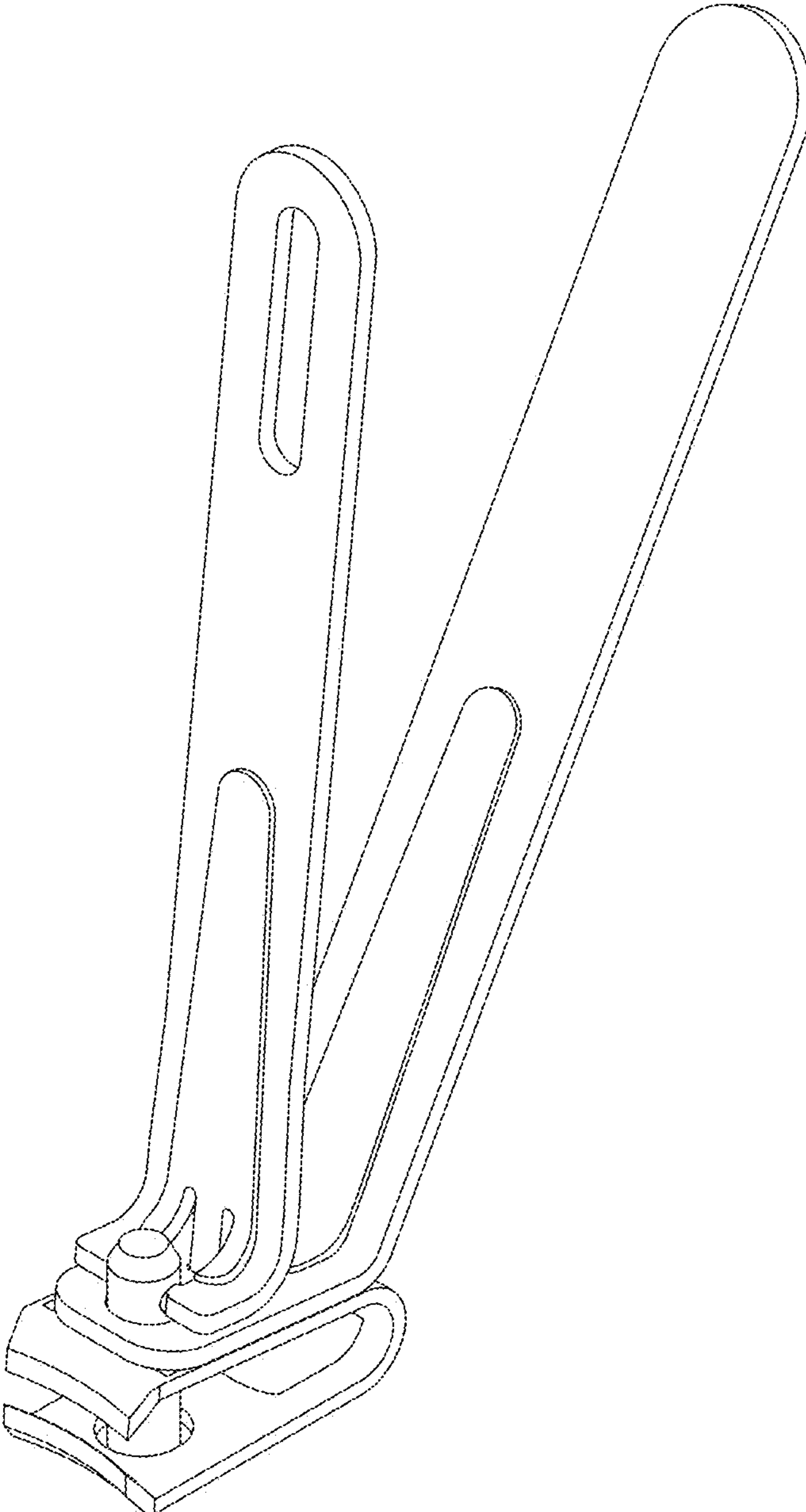

FIG. 2

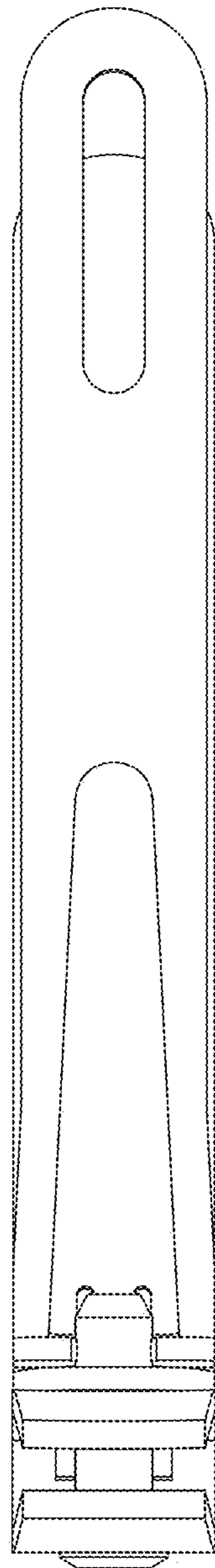

FIG. 3

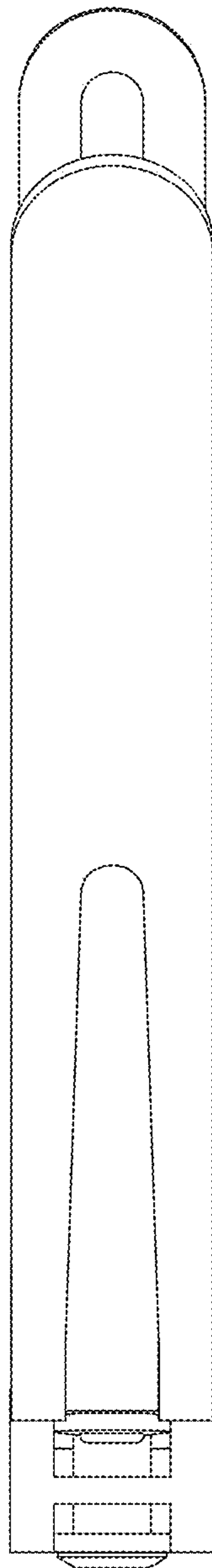

FIG. 4

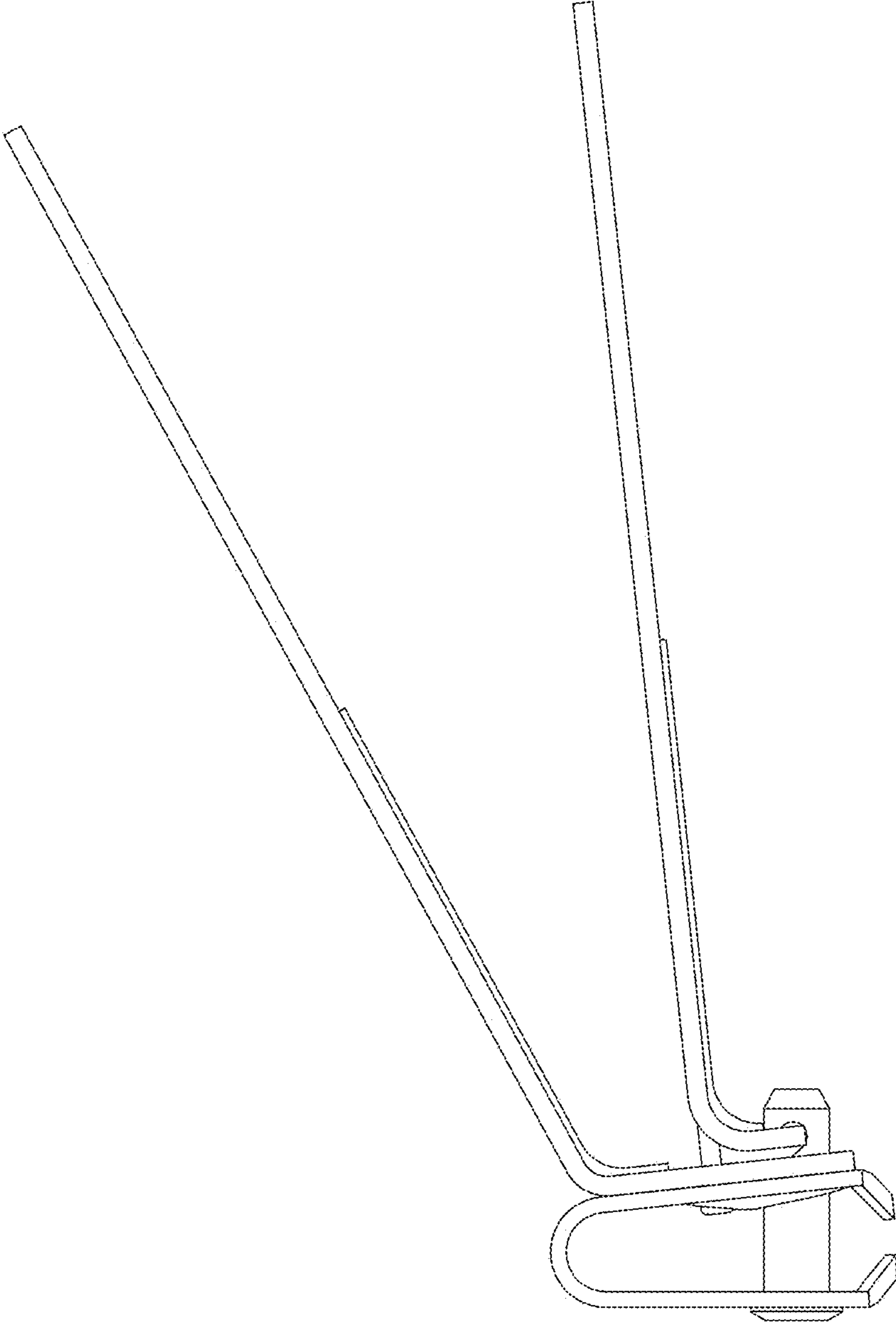

FIG. 5

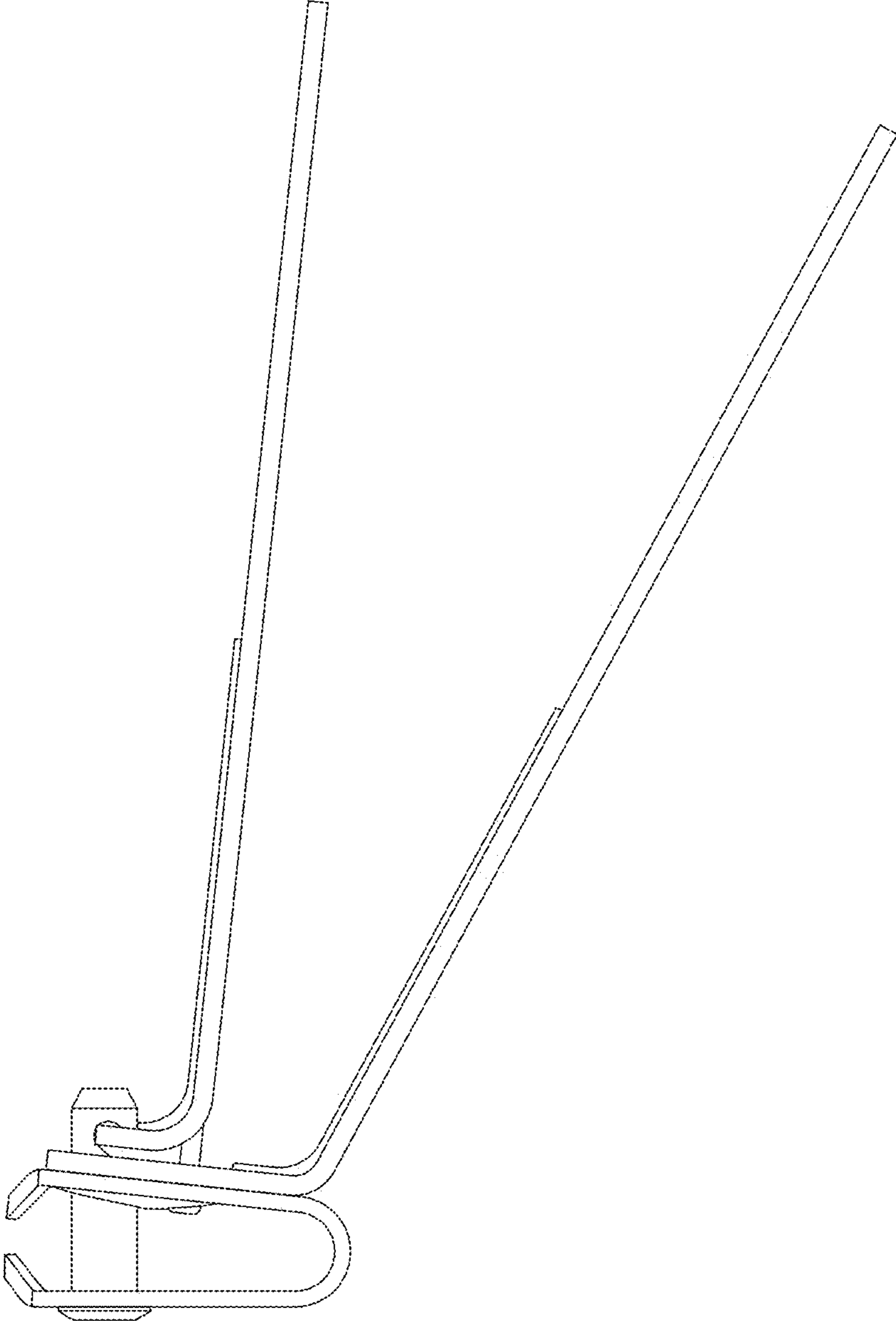

FIG. 6

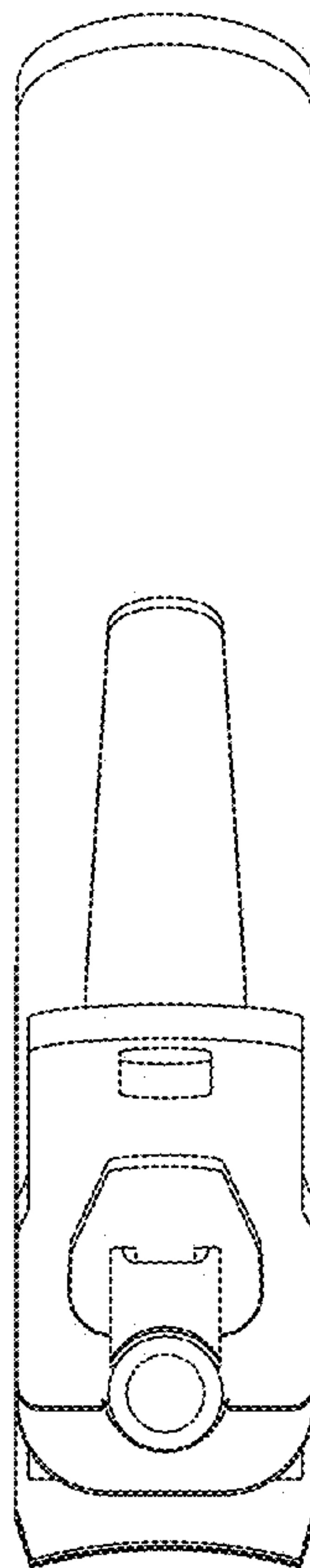

FIG. 7

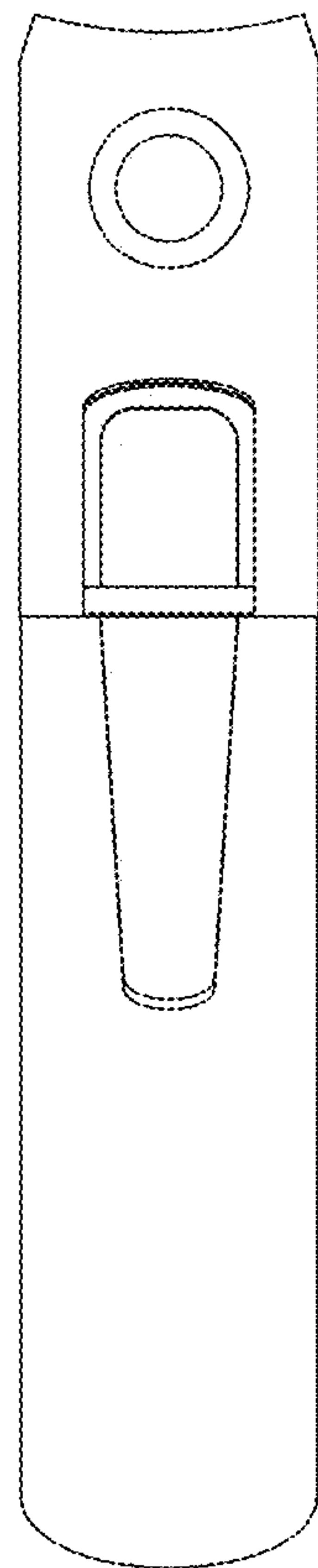

FIG. 8

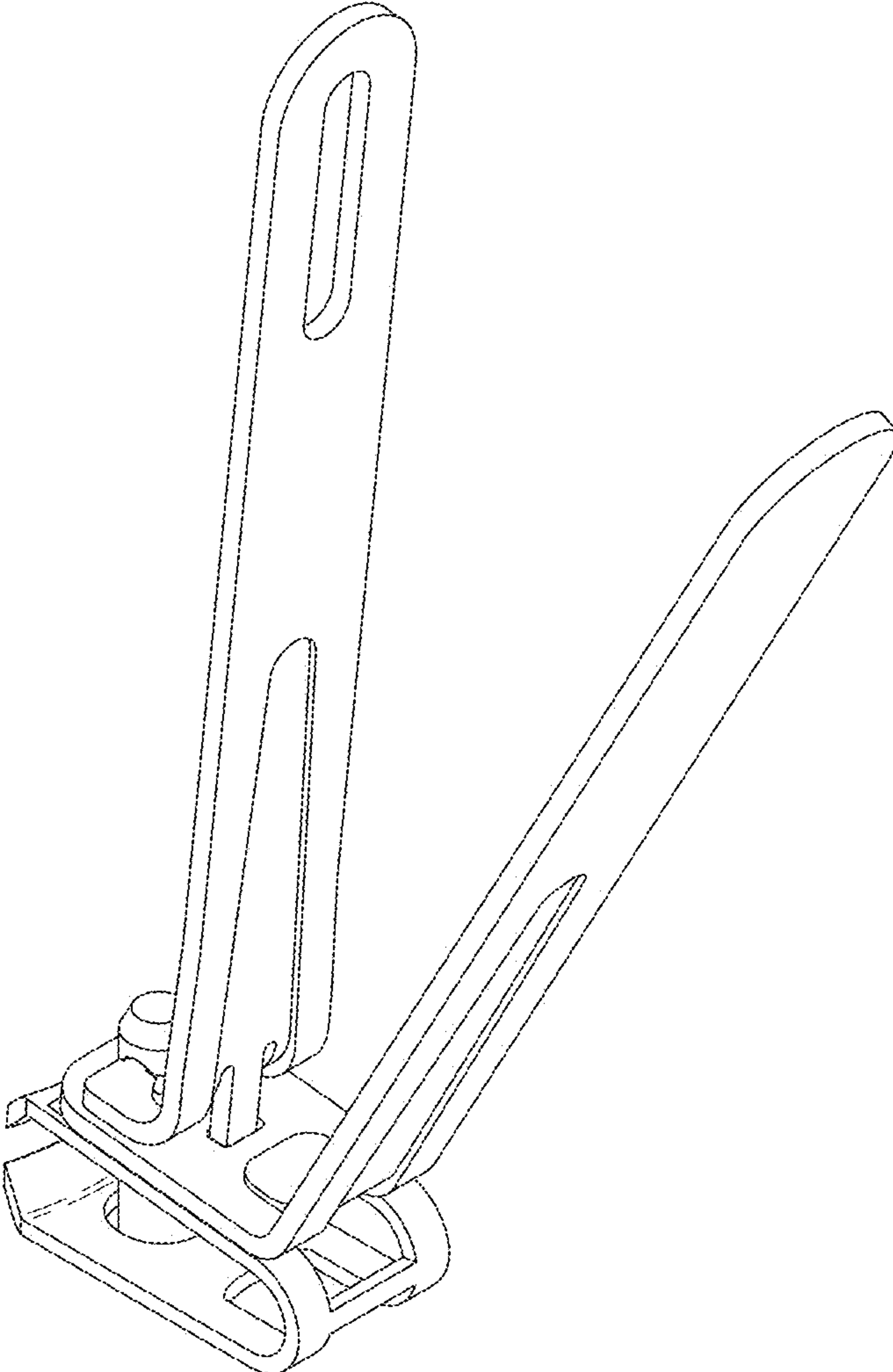

FIG. 9

