



US00D919411S

(12) **United States Design Patent** (10) **Patent No.:** **US D919,411 S**
Richter et al. (45) **Date of Patent:** **** May 18, 2021**

(54) **VEHICLE KEY**

Primary Examiner — Susan E Krakower

Assistant Examiner — Jerry Shiuan-Hua Hsu

(71) Applicant: **VOLKSWAGEN
AKTIENGESELLSCHAFT,**
Wolfsburg (DE)

(74) *Attorney, Agent, or Firm* — Lucas & Mercanti, LLP;
Klaus P. Stoffel

(72) Inventors: **Thorsten Richter,** Wolfsburg (DE);
Jens Kohlhase, Wolfsburg (DE); **Bernd
Soltendieck,** Wolfsburg (DE)

(57) **CLAIM**

The ornamental design for a vehicle key, as shown and described.

(73) Assignee: **VOLKSWAGEN
AKTIENGESELLSCHAFT,**
Wolfsburg (DE)

DESCRIPTION

(**) Term: **15 Years**

FIG. 1 is a top view of the vehicle key of the present invention;

(21) Appl. No.: **29/704,593**

FIG. 2 is a bottom view thereof;

(22) Filed: **Sep. 5, 2019**

FIG. 3 is a top, left-side perspective view thereof;

(30) **Foreign Application Priority Data**

Mar. 5, 2019 (DE) 40 2019 100 259.6

FIG. 4 is a bottom, right-side perspective view thereof;

(51) **LOC (13) Cl.** **08-07**

FIG. 5 is a left side view thereof, shown enlarged for ease of illustration;

(52) **U.S. Cl.**
USPC **D8/347**

FIG. 6 is a right side view thereof, shown enlarged for ease of illustration;

(58) **Field of Classification Search**
USPC D19/121, 157; D3/207–212; D8/43,
D8/347, 348; D10/64, 104.1, 106.1;
(Continued)

FIG. 7 is a rear view thereof, shown enlarged for ease of illustration;

(56) **References Cited**

U.S. PATENT DOCUMENTS

D356,746 S * 3/1995 Dziarsk D10/104.1
D358,543 S * 5/1995 Amber D8/347
(Continued)

FIG. 8 is a front view thereof, shown enlarged for ease of illustration;

FIG. 9 is a top view of a second embodiment of the vehicle key of the present invention;

FIG. 10 is a bottom view thereof;

FIG. 11 is a top, right-side perspective view thereof;

FIG. 12 is a bottom, right-side perspective view thereof;

FIG. 13 is a left side view thereof, shown enlarged for ease of illustration;

FIG. 14 is a right side view thereof, shown enlarged for ease of illustration;

FIG. 15 is a rear view thereof, shown enlarged for ease of illustration; and,

FIG. 16 is a front view thereof, shown enlarged for ease of illustration.

FOREIGN PATENT DOCUMENTS

EM 001342174 9/2012
EM 001347280 10/2012
EM 001353775 12/2012

1 Claim, 8 Drawing Sheets

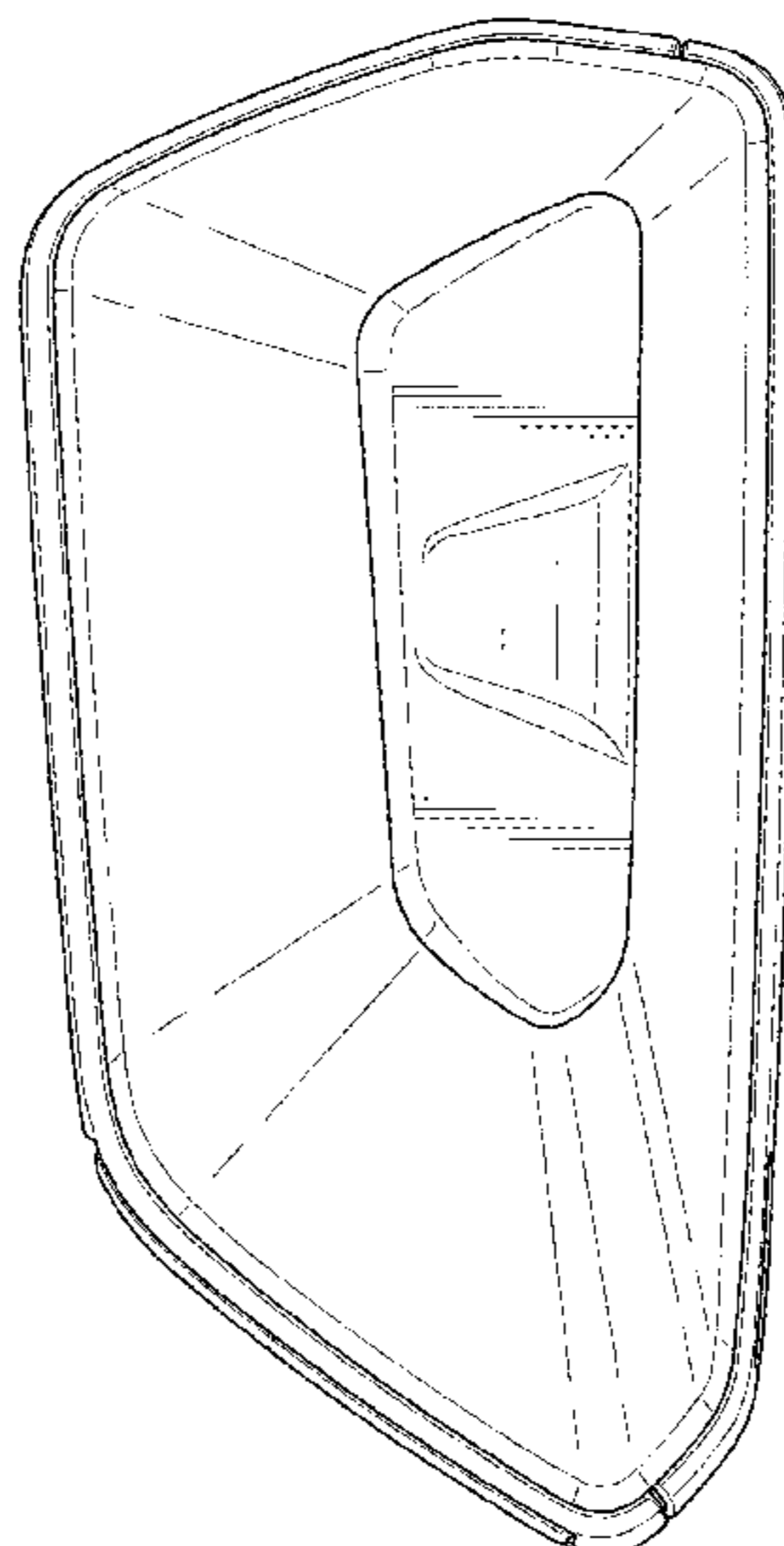

(58) **Field of Classification Search**

USPC D11/1, 2, 14, 26, 27, 28, 29, 89, 90, 91,
D11/92, 44, 48, 81, 99; D12/400, 401,
D12/404, 406, 412, 414, 222, 223, 86, 93,
D12/101, 195; D13/168
CPC E05B 17/0062; E05B 19/043; E05B
19/0082; E05B 19/00; E05B 19/20; E05B
19/04; E05B 11/00; E05B 13/00; B25G
1/08; A45F 5/02; A45C 11/324

See application file for complete search history.

(56) **References Cited**

U.S. PATENT DOCUMENTS

D383,895 S *	9/1997	Christie	D3/208
D433,921 S *	11/2000	Van Den Acker	D8/347
D528,990 S *	9/2006	Li	D13/168
D639,547 S *	6/2011	Stefanov	D3/207
D720,603 S *	1/2015	Kirzinger	D8/346
D730,150 S *	5/2015	Kirzinger	D8/347
D730,152 S *	5/2015	Kirzinger	D8/347
D743,240 S *	11/2015	Bachorski	D8/347
D744,811 S *	12/2015	Bischoff	D8/347
D749,398 S *	2/2016	Bachorski	D8/347
D844,574 S *	4/2019	Kandler	D13/168

* cited by examiner

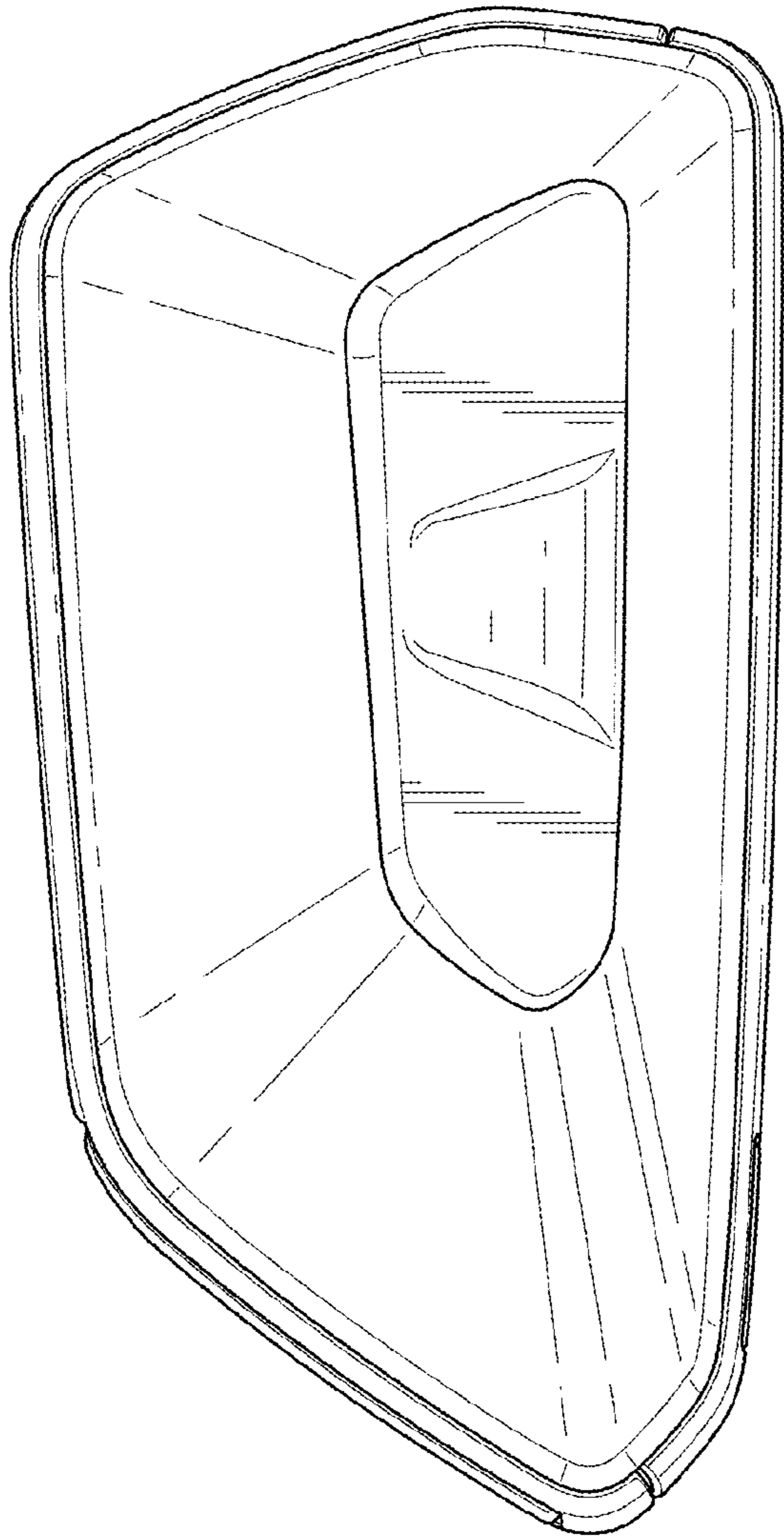

FIG. 1

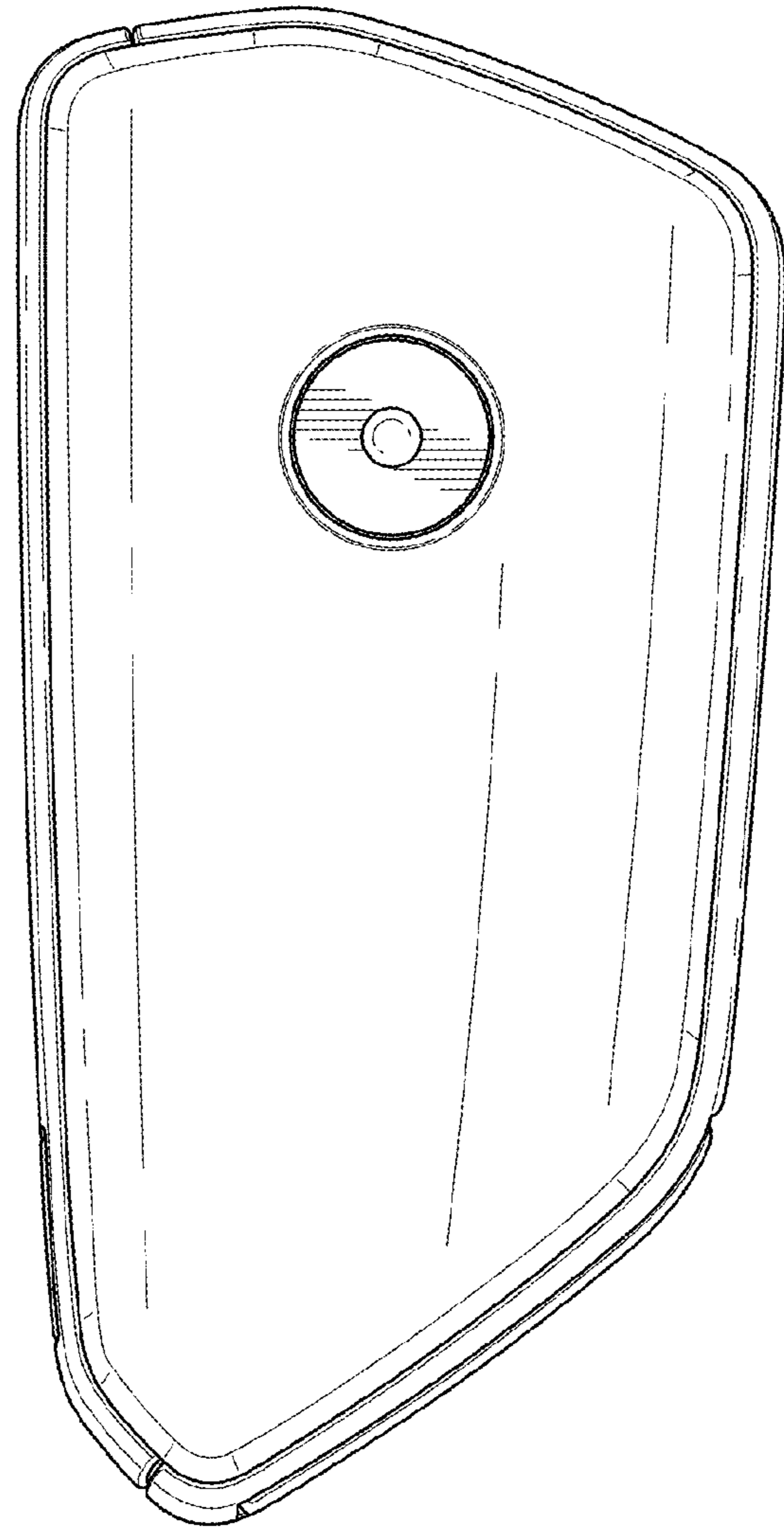

FIG. 2

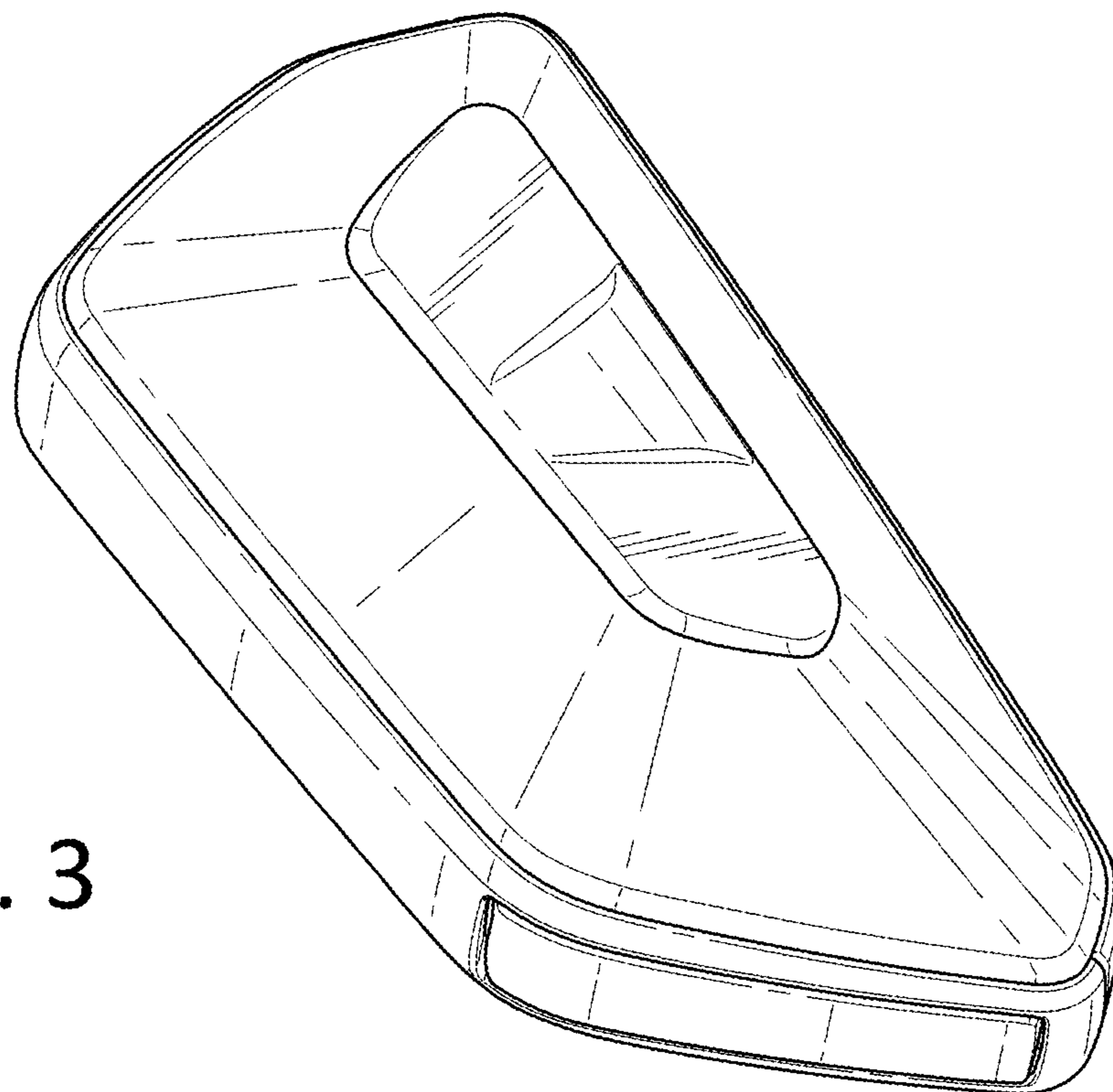

FIG. 3

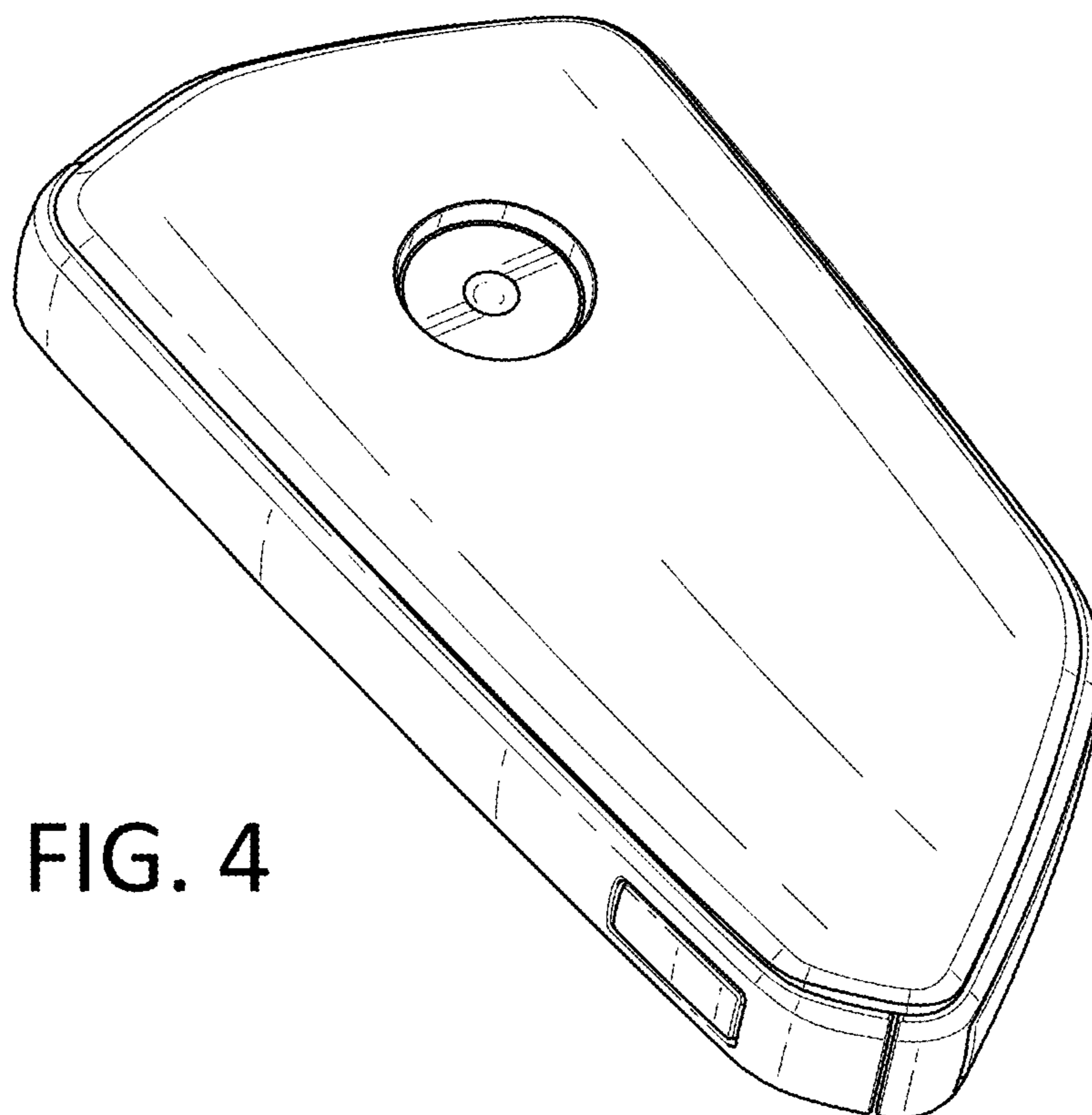

FIG. 4

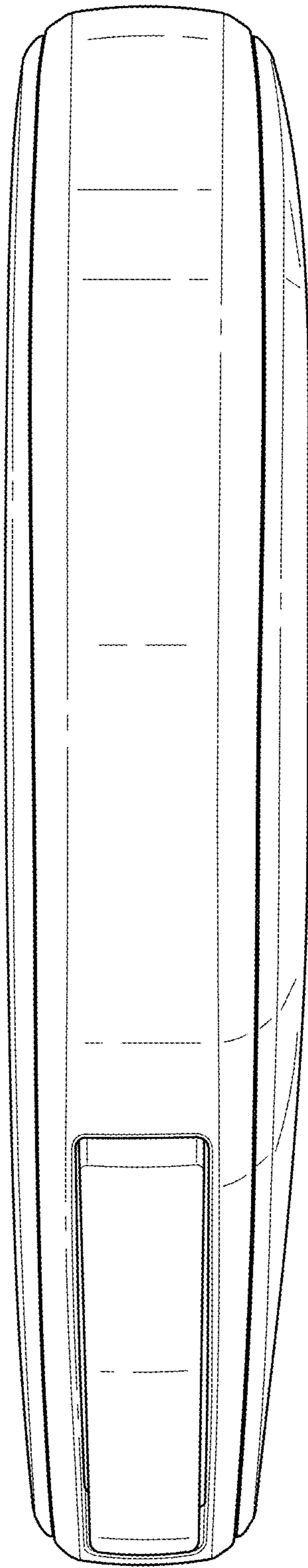

FIG. 5

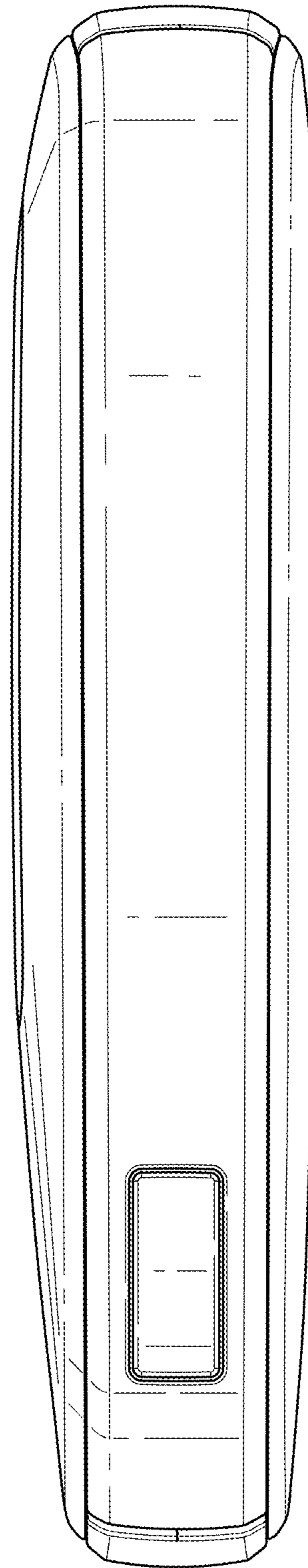

FIG. 6

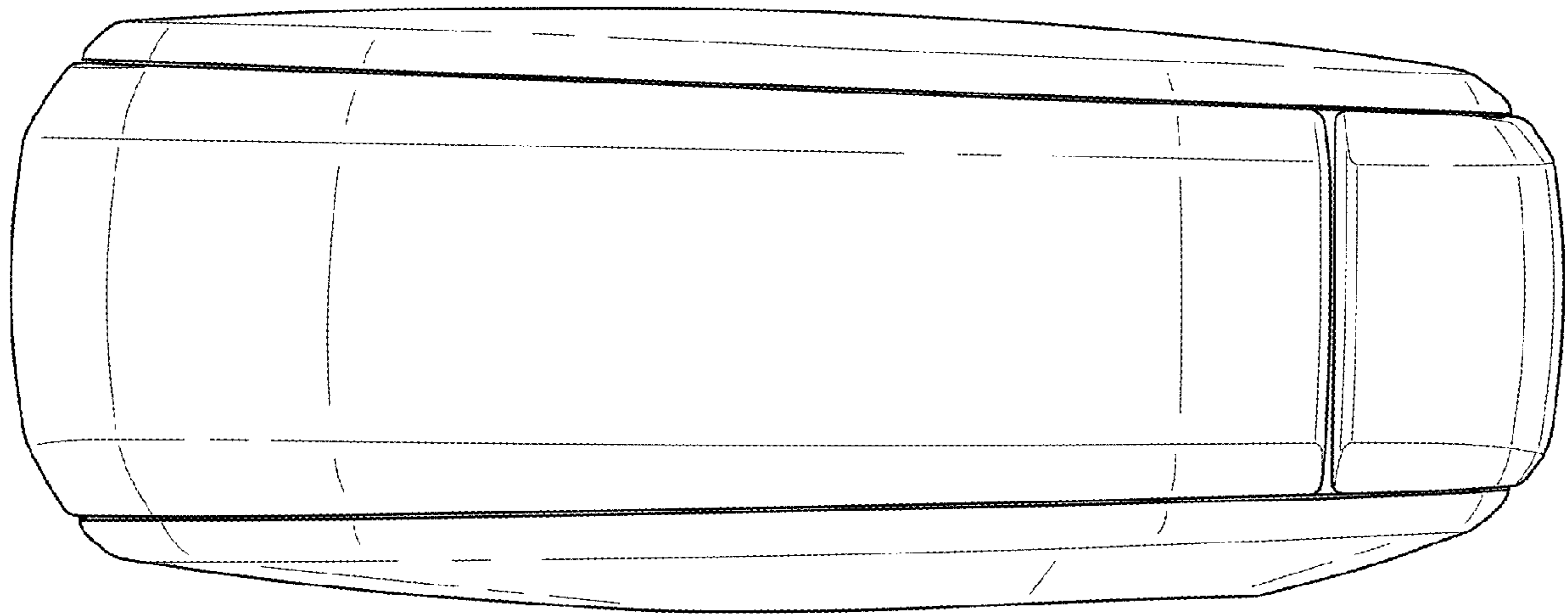

FIG. 7

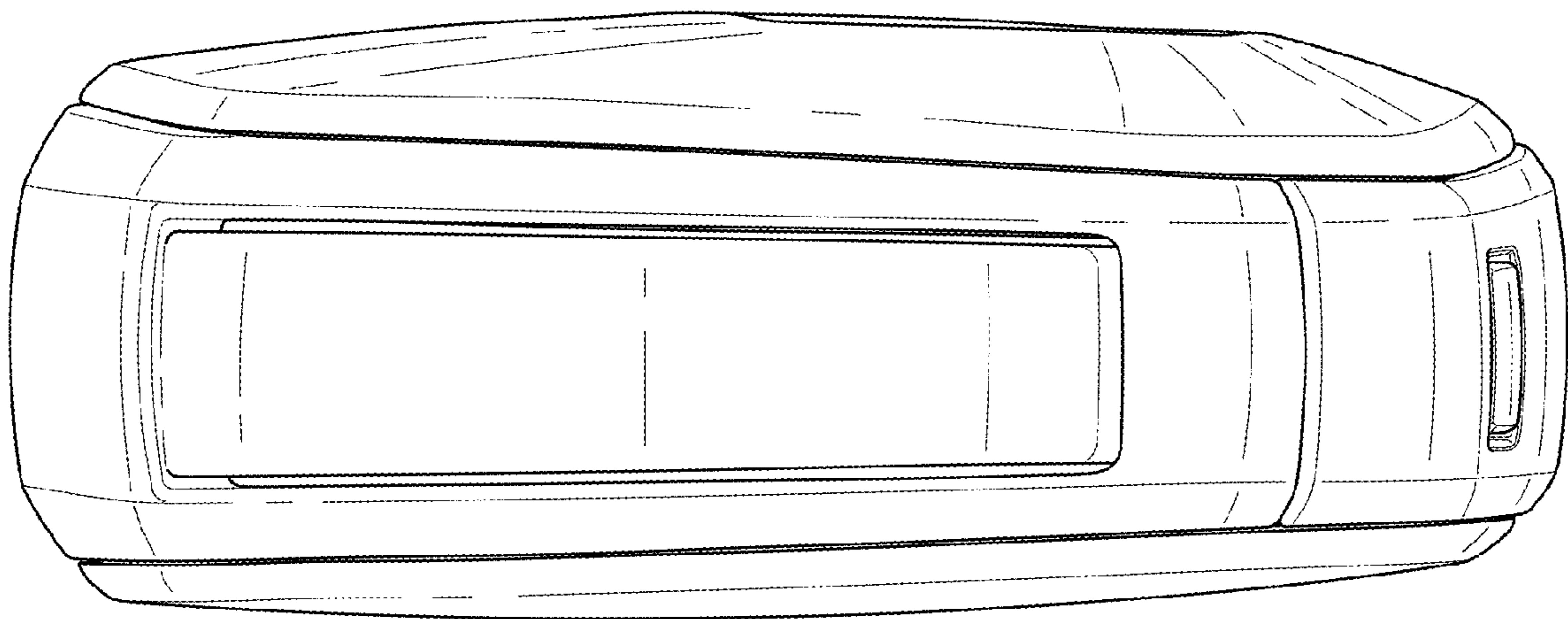

FIG. 8

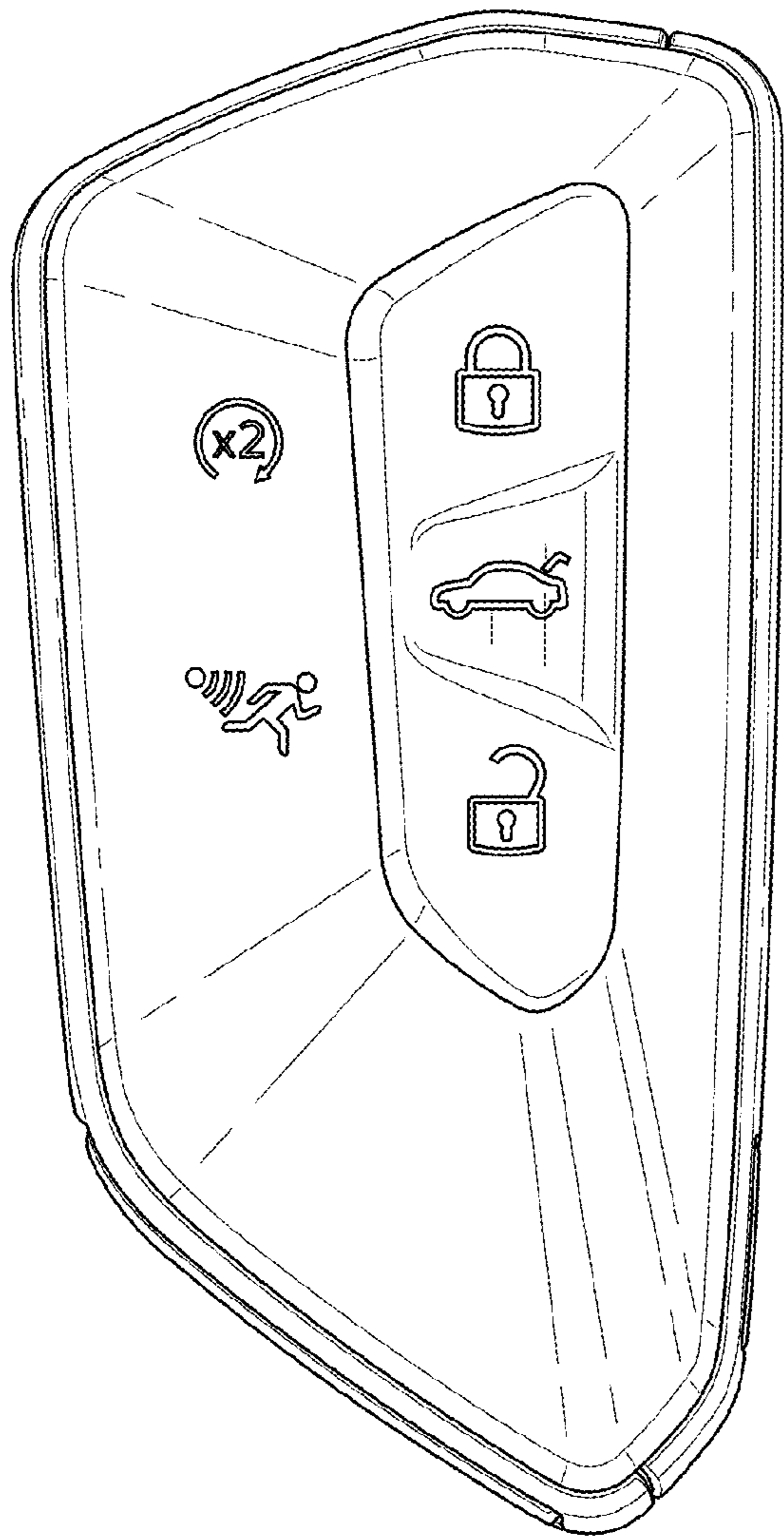

FIG. 9

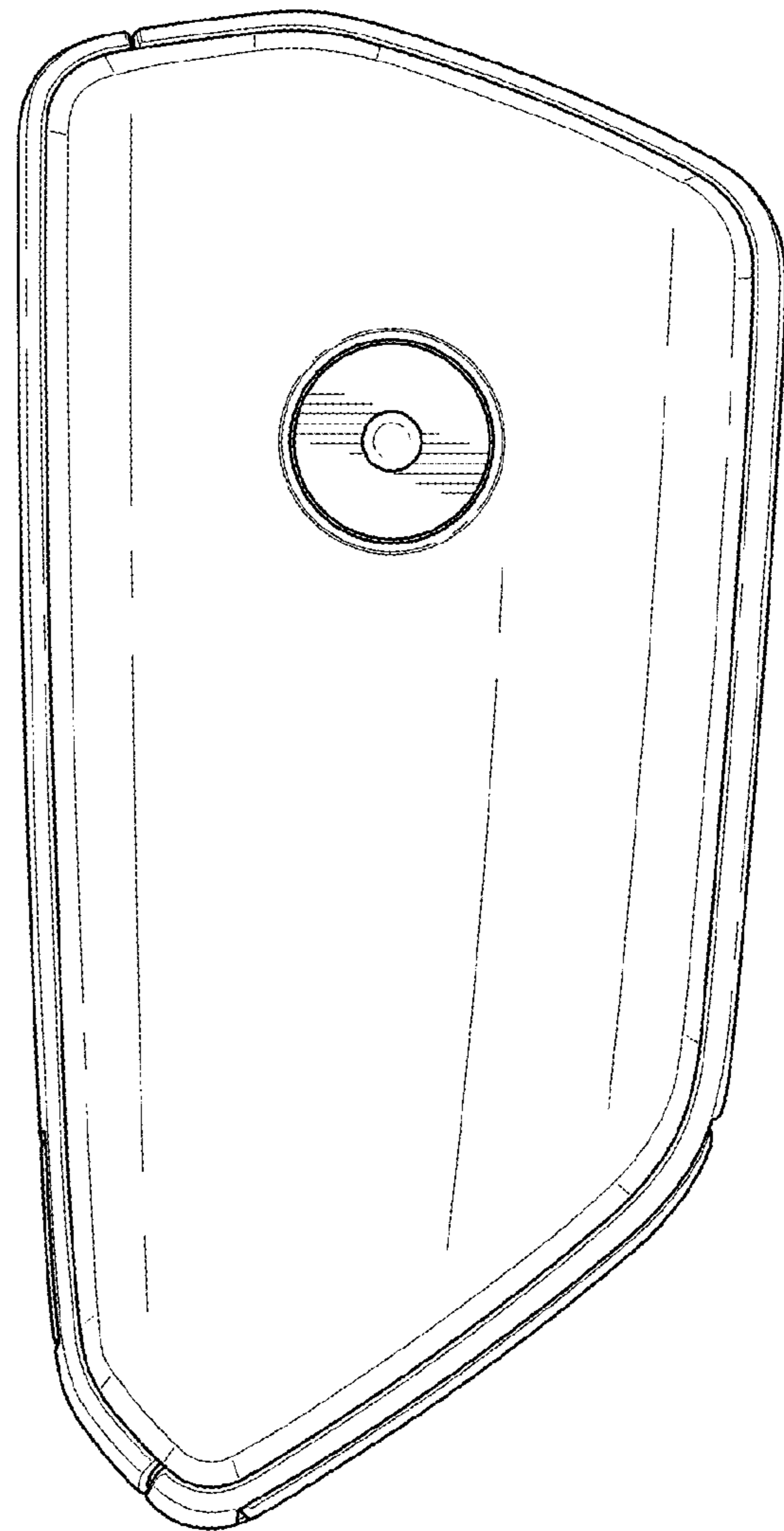

FIG. 10

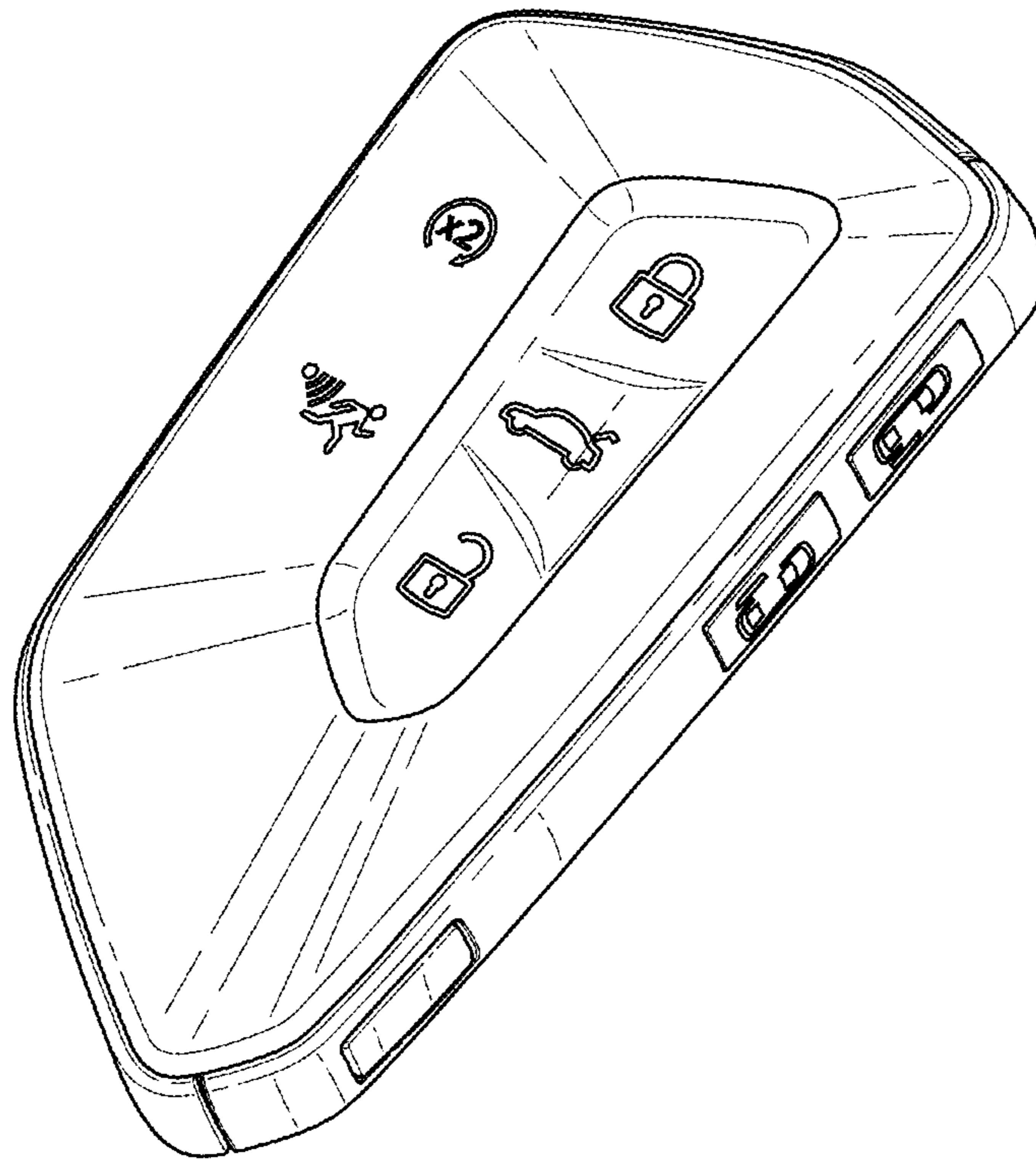

FIG. 11

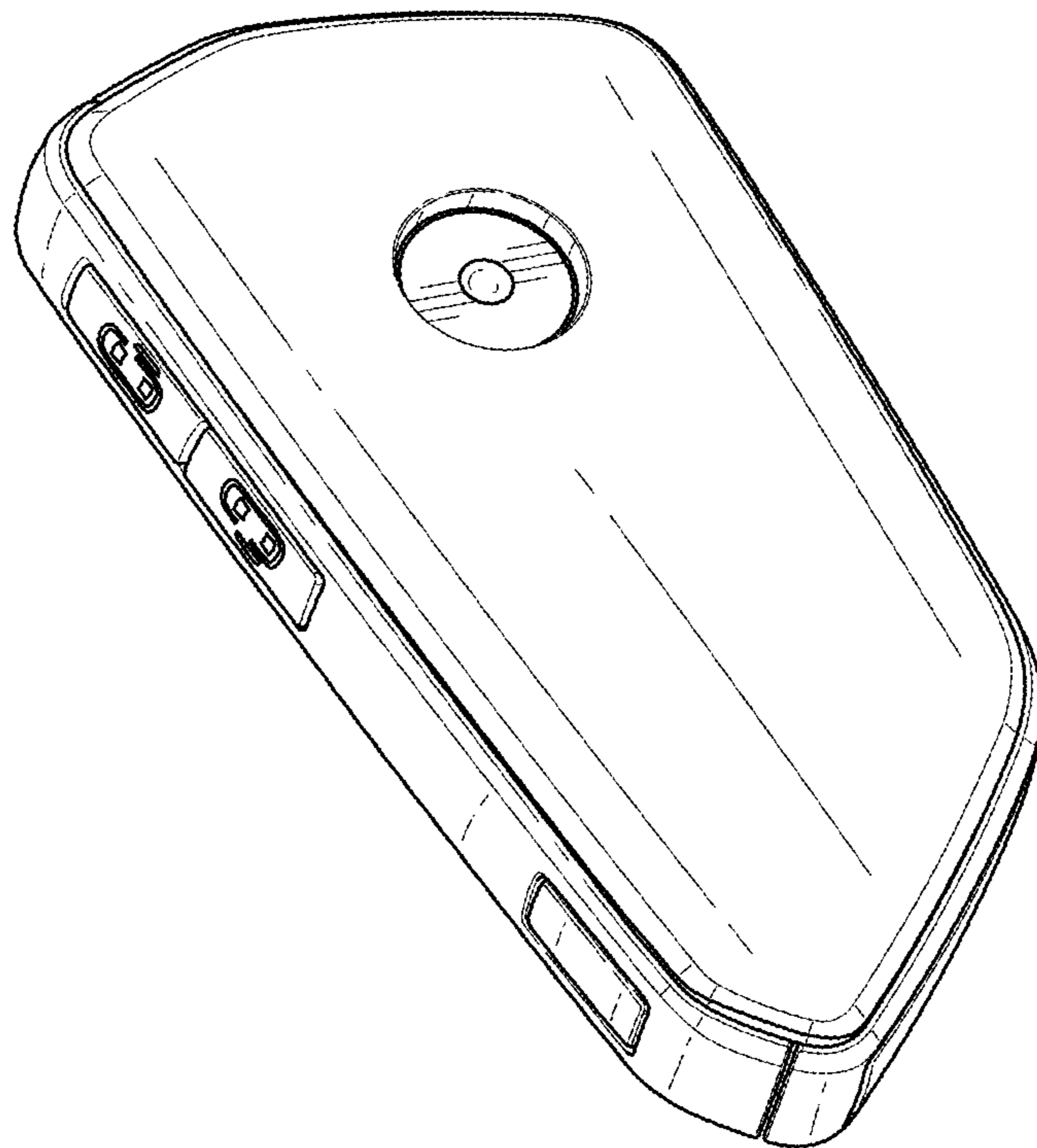

FIG. 12

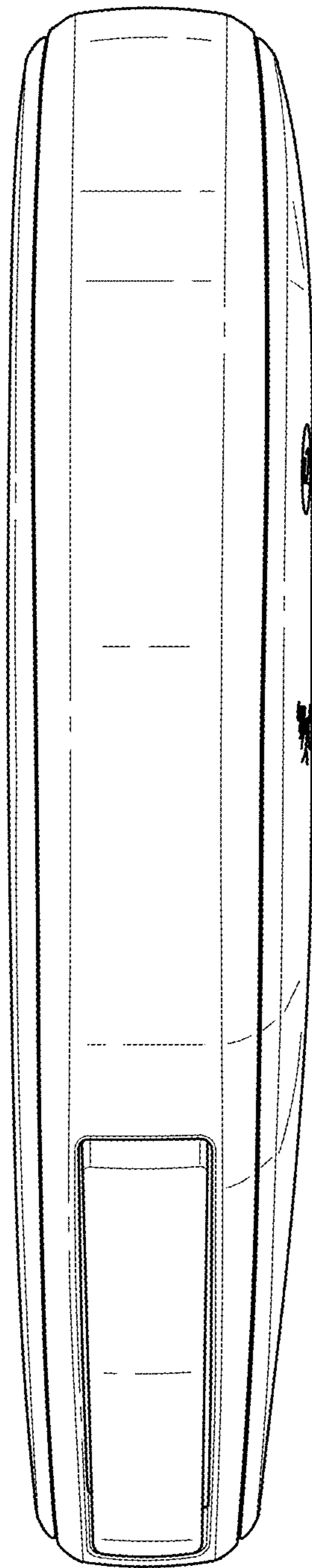

FIG. 13

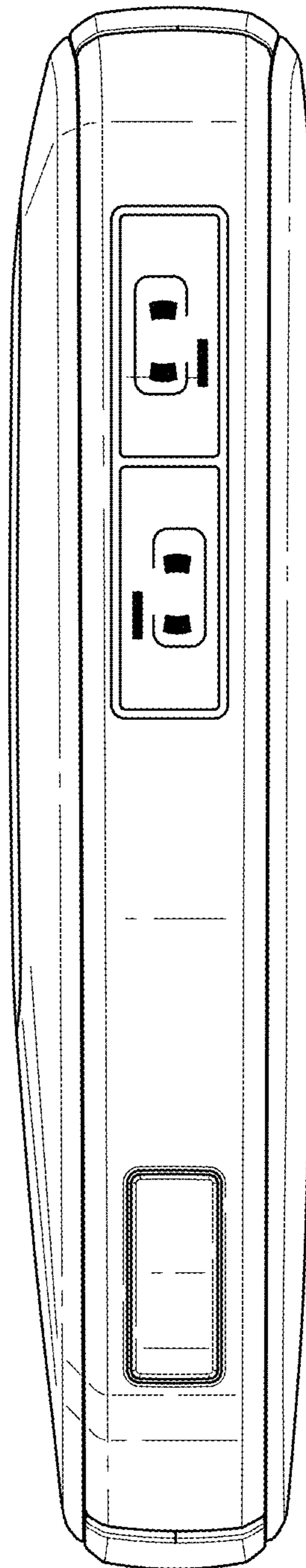

FIG. 14

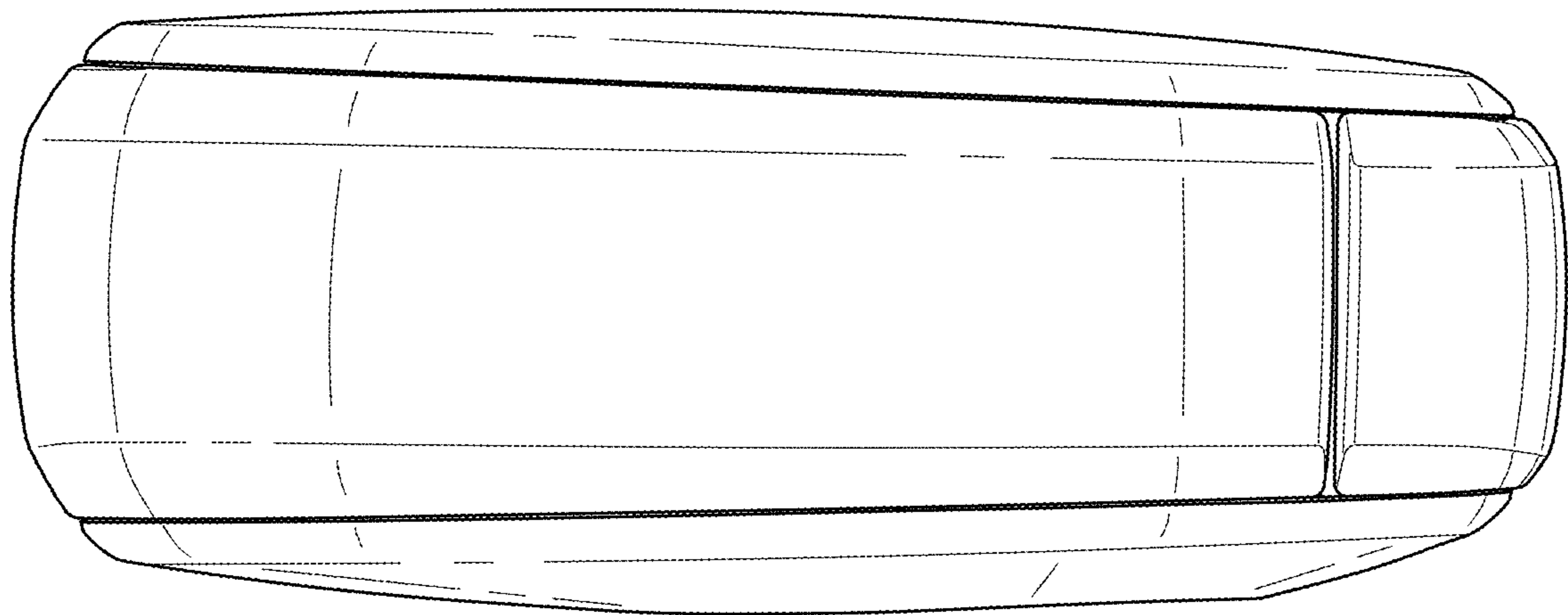

FIG. 15

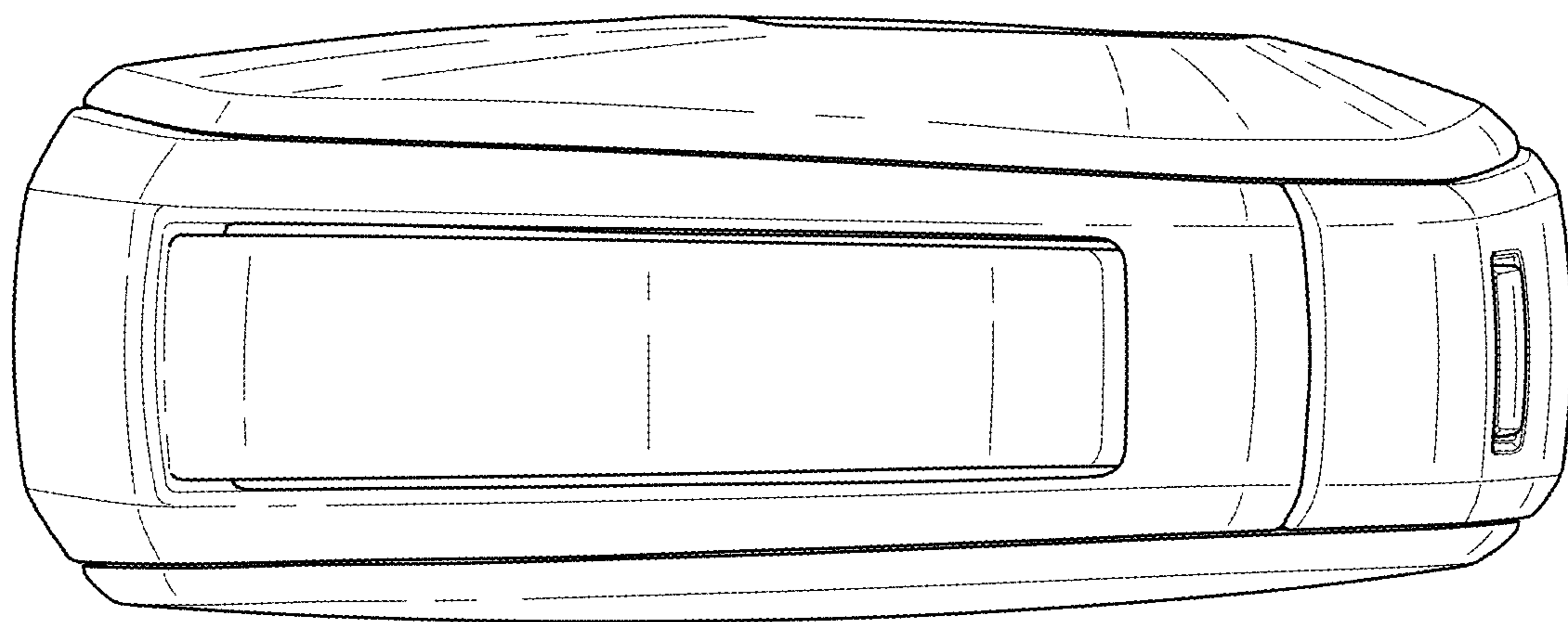

FIG. 16