



US00D919386S

(12) **United States Design Patent** (10) **Patent No.:** **US D919,386 S**
Byeon et al. (45) **Date of Patent:** **** May 18, 2021**

(54) **PEELER HANDLE**
(71) Applicant: **Dart Industries Inc.**, Orlando, FL (US)
(72) Inventors: **Dongjin Byeon**, Aalst (BE); **Frederick M. N. De Pauw**, Wetteren (BE); **Nathalie De Beer**, Herzele (BE)
(73) Assignee: **Dart Industries Inc.**, Orlando, FL (US)

D766,681 S * 9/2016 Hartshorn D7/695
D859,093 S * 9/2019 Umholtz D7/695
D859,094 S * 9/2019 Umholtz D7/695
D859,095 S * 9/2019 Umholtz D7/695
D859,096 S * 9/2019 Umholtz D7/695
D872,525 S * 1/2020 Hiltenbrand D7/393
2004/0117991 A1 * 6/2004 Haberstroh A47J 17/02
30/279.6
2012/0085249 A1 * 4/2012 Kuan A47J 17/02
99/584

(**) Term: **15 Years**

OTHER PUBLICATIONS

(21) Appl. No.: **29/703,189**

Tupperware Citrus Peeler; 1970.

(22) Filed: **Aug. 26, 2019**

* cited by examiner

(51) **LOC (13) Cl.** **07-06**

Primary Examiner — Janice Hallmark

(52) **U.S. Cl.**

Assistant Examiner — Omeed Agilee

USPC **D7/695**

(74) *Attorney, Agent, or Firm* — Taylor J. Ross

(58) **Field of Classification Search**

(57) **CLAIM**

USPC D7/368, 393, 395, 669, 680–696
CPC A47J 17/02; A47J 45/061; A47J 43/288;
B26D 1/03

The ornamental design for a peeler handle, as shown and described.

See application file for complete search history.

DESCRIPTION

(56) **References Cited**

FIG. 1 is a top, front and right side isometric view of a peeler handle showing our new design;
FIG. 2 is a top, rear and left side isometric view thereof;
FIG. 3 is a top plan view thereof;
FIG. 4 is a bottom plan view thereof;
FIG. 5 is a front elevation view, the rear elevation being a mirror image thereof;
FIG. 6 is a left side elevation view thereof;
FIG. 7 is a right side elevation view thereof; and,
FIG. 8 is a cross-sectional view taken along line 8-8 of FIG. 3.

U.S. PATENT DOCUMENTS

691,861 A * 1/1902 Hemstrom B26B 27/00
30/280
D114,672 S * 5/1939 Goughian D7/695
D354,888 S 1/1995 Cousins
D407,277 S 3/1999 Cousins
D479,445 S * 9/2003 Chang D7/695
D611,780 S 3/2010 Laib
D674,253 S * 1/2013 Spiegel D7/695
D674,254 S * 1/2013 Spiegel D7/695
D675,890 S * 2/2013 Reay D7/695
D720,191 S * 12/2014 Bhasin D7/695

1 Claim, 5 Drawing Sheets

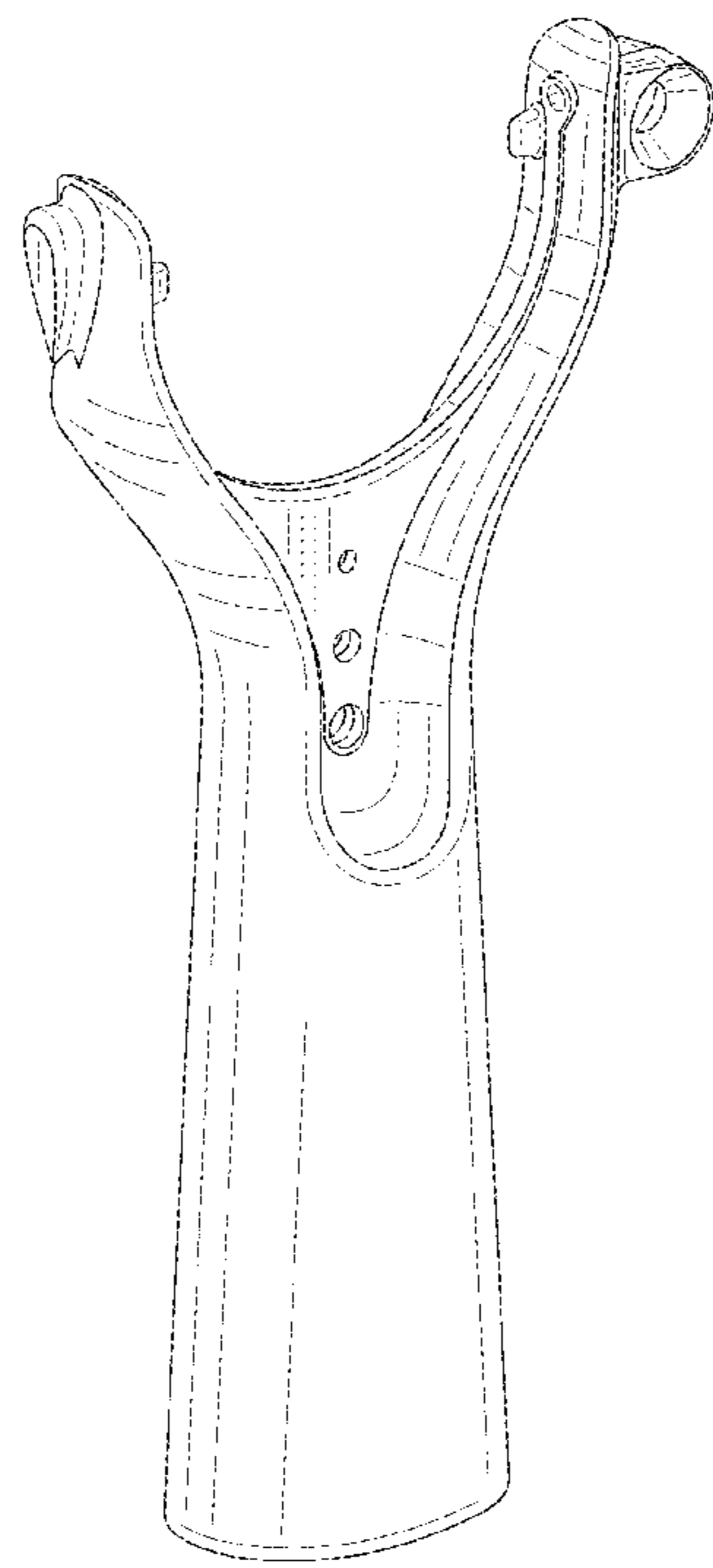

FIG. 1

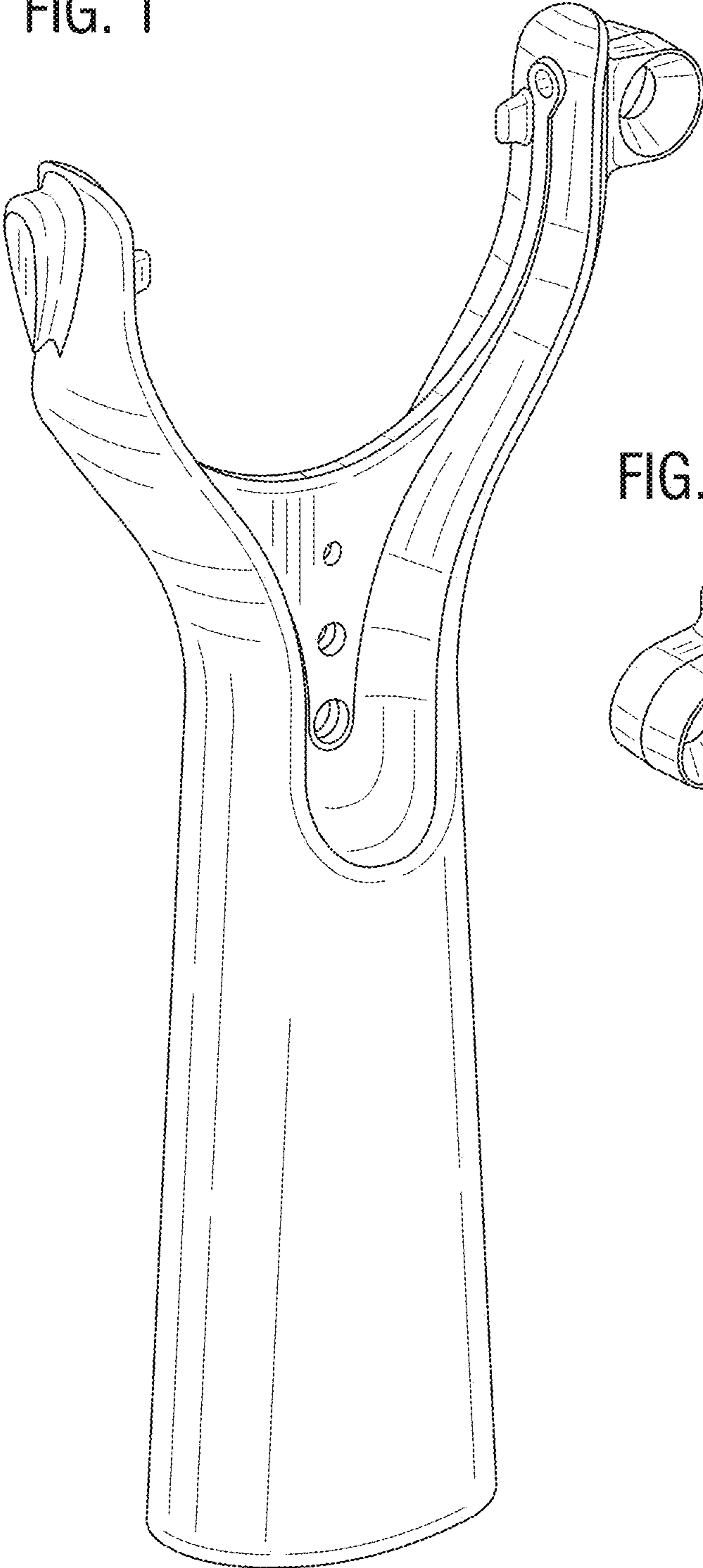

FIG. 2

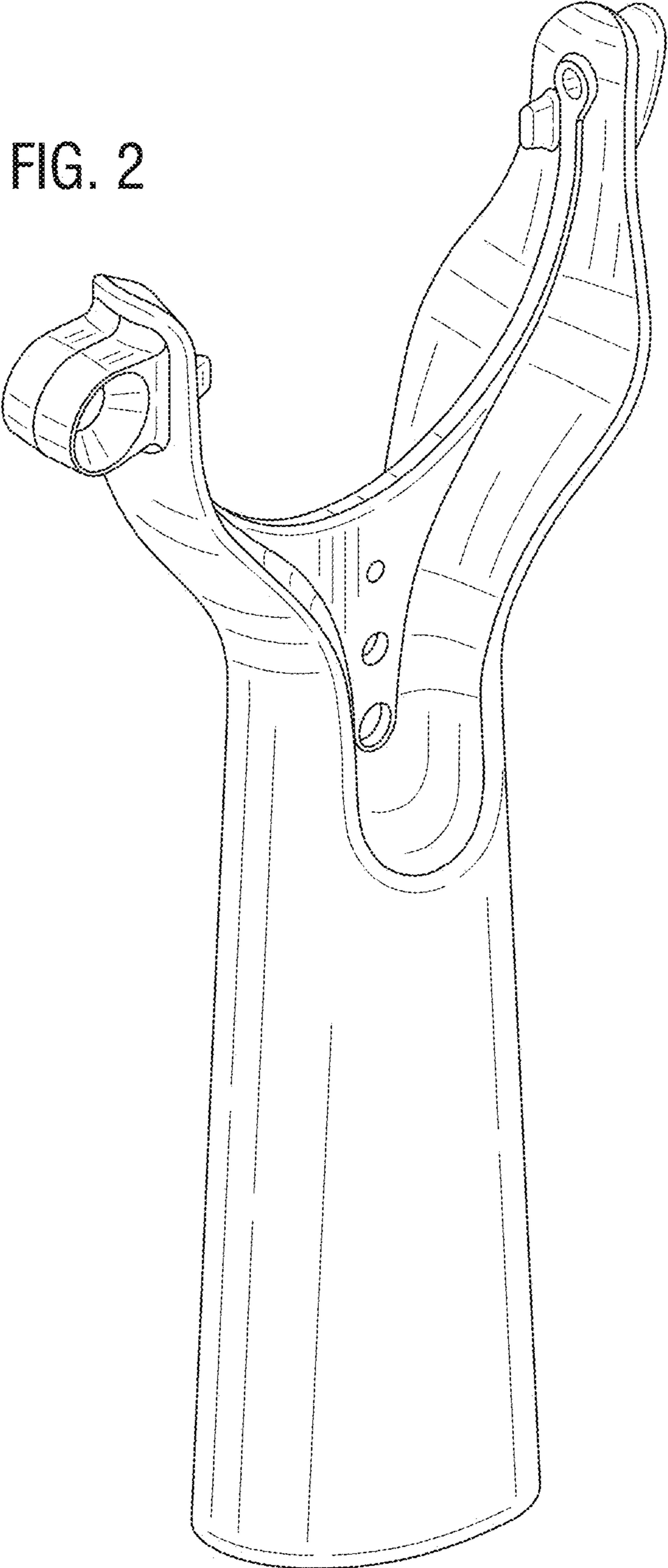

FIG. 3

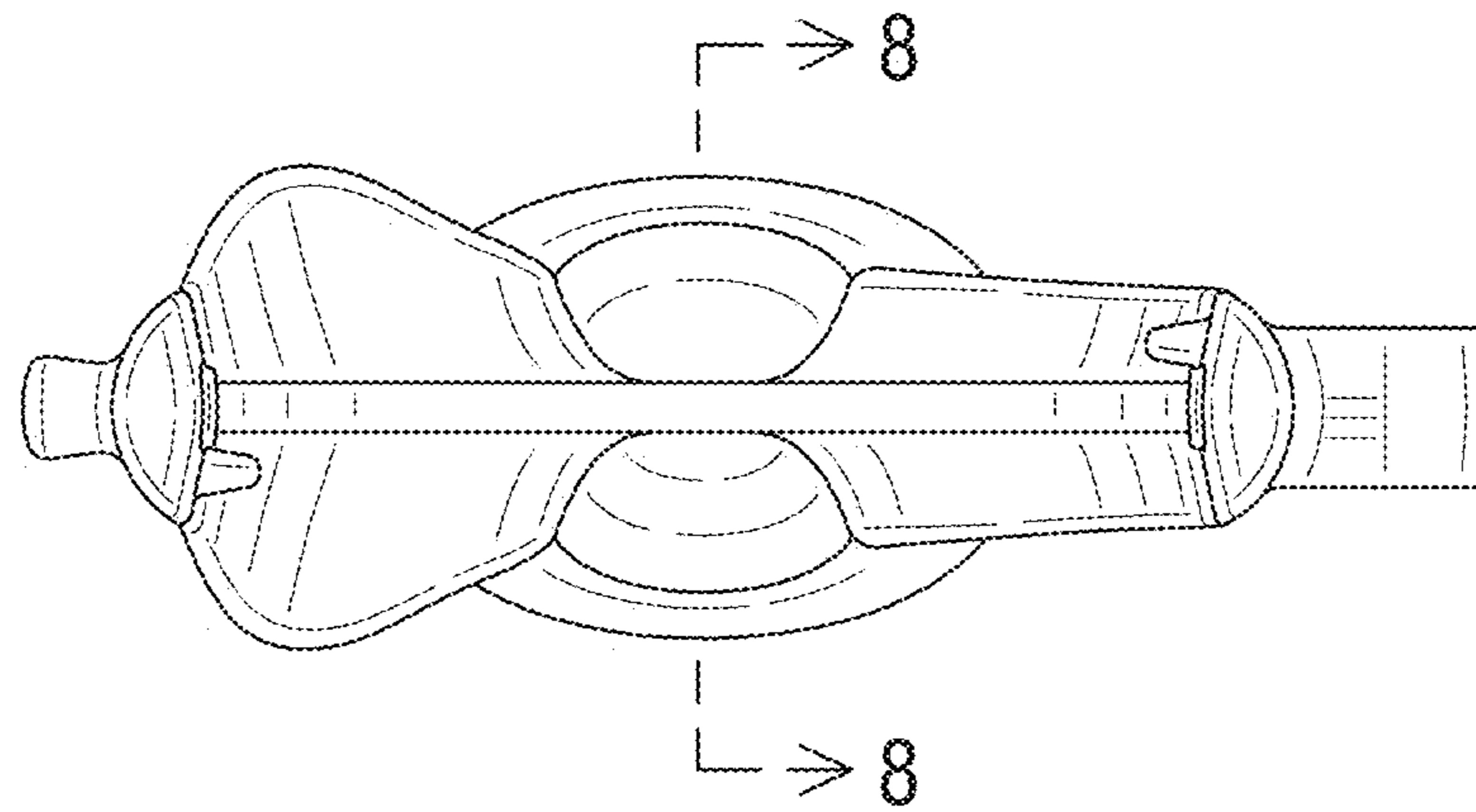

FIG. 4

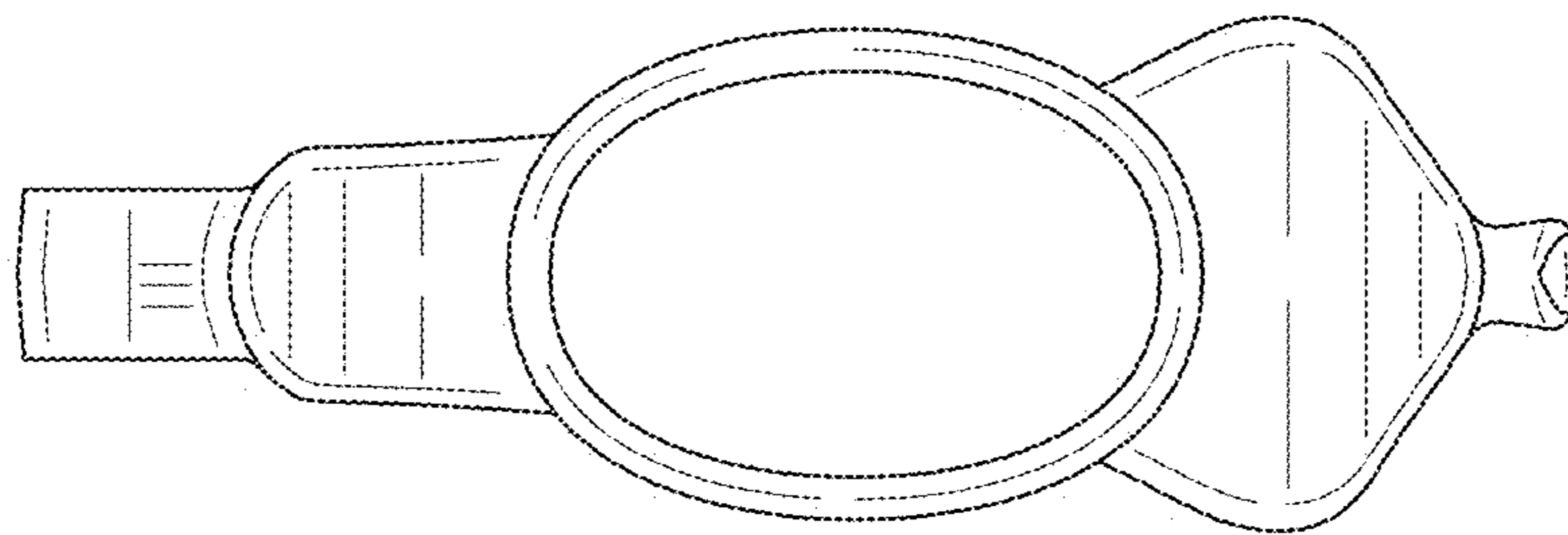

FIG. 5

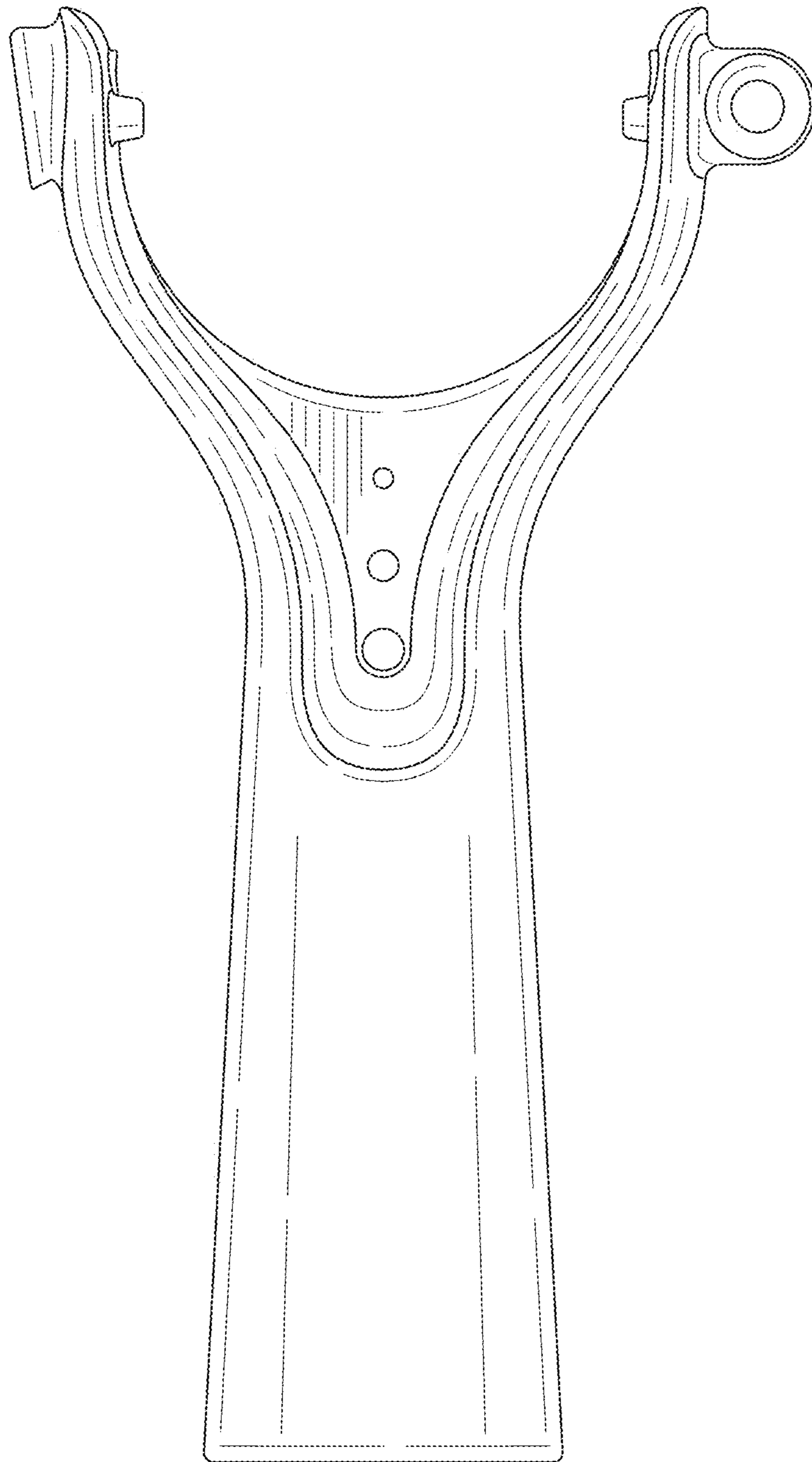

FIG. 6

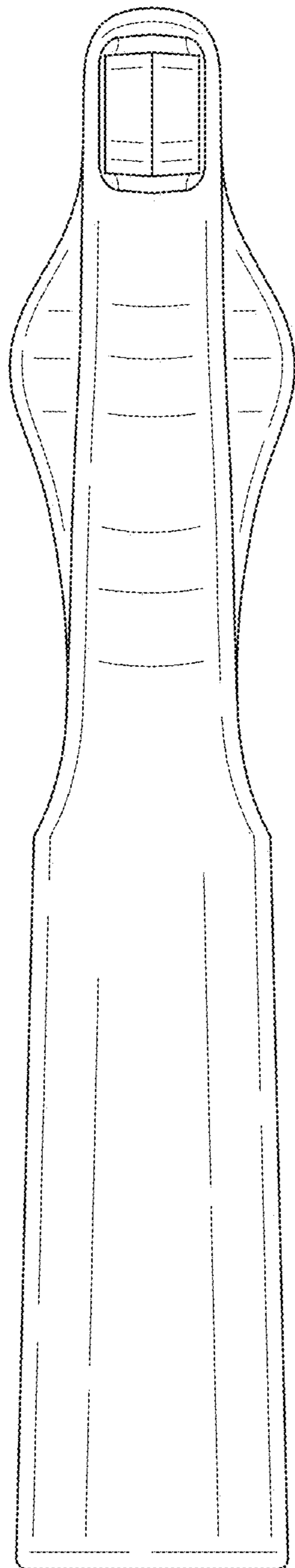

FIG. 7

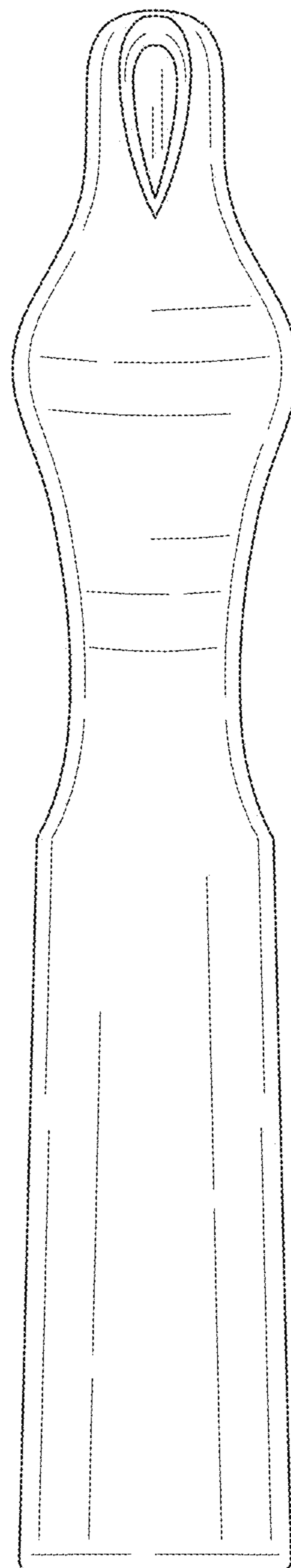

FIG. 8

