



US00D919256S

(12) **United States Design Patent** (10) **Patent No.:** **US D919,256 S**
Thompson (45) **Date of Patent:** **** May 18, 2021**

(54) **FOOTWEAR**
(71) Applicant: **Crocs, Inc.**, Niwot, CO (US)
(72) Inventor: **Holly Thompson**, Loveland, CO (US)
(73) Assignee: **Crocs, Inc.**, Broomfield, CO (US)
(**) Term: **15 Years**
(21) Appl. No.: **29/699,918**
(22) Filed: **Jul. 30, 2019**
(51) **LOC (13) Cl.** **02-04**
(52) **U.S. Cl.**
USPC **D2/923**
(58) **Field of Classification Search**
USPC D2/896, 900, 916, 917, 923, 943,
D2/946-96, 969, 972
CPC A43B 5/08; A43B 1/10; A43B 3/12; A43B
3/10
See application file for complete search history.

D624,733 S * 10/2010 O'Boyle D2/923
D648,105 S * 11/2011 Schlageter D2/923
D664,753 S 8/2012 Santos
D667,612 S 9/2012 Del Biondi et al.
D677,039 S * 3/2013 Lubart D2/923
D683,940 S 6/2013 Del Biondi
D691,351 S 10/2013 Pugazhenth
D698,133 S 1/2014 Callegarini et al.
D698,531 S 2/2014 Lock et al.
D708,827 S 7/2014 Kue
D709,677 S 7/2014 del Biondi
D718,518 S * 12/2014 Del Biondi D2/923
D726,397 S 4/2015 Del Biondi et al.

(Continued)

OTHER PUBLICATIONS

Calzuro Buddy, posted at calzuro.it, <https://www.calzuro.it/en/footwear/buddy.htm>, downloaded Dec. 23, 2020 (5 pages).

(Continued)

Primary Examiner — Rashida C. Walshon
(74) *Attorney, Agent, or Firm* — Wilmer Cutler Pickering
Hale and Dorr LLP

(56) **References Cited**

U.S. PATENT DOCUMENTS

D448,918 S * 10/2001 Hoyt D2/916
D517,789 S 3/2006 Seamans
D517,790 S * 3/2006 Seamans D2/969
D564,204 S 3/2008 Seamans
D564,205 S 3/2008 Seamans
D564,207 S 3/2008 Seamans
D567,482 S * 4/2008 Hoyt D2/896
D575,034 S * 8/2008 Hoyt D2/896
D575,499 S * 8/2008 Seamans D2/972
D575,942 S 9/2008 del Biondi et al.
D576,387 S 9/2008 del Biondi et al.
D590,588 S 4/2009 del Biondi et al.
D593,286 S 6/2009 Del Biondi et al.
D593,287 S 6/2009 Del Biondi et al.
D599,538 S * 9/2009 del Biondi D2/902
D610,784 S * 3/2010 Del Biondi D2/916

(57) **CLAIM**

The ornamental design for footwear, as shown and described.

DESCRIPTION

FIG. 1 is a top perspective view of footwear;
FIG. 2 is a front view thereof;
FIG. 3 is a back view thereof;
FIG. 4 is an outer side view thereof;
FIG. 5 is an inner side view thereof;
FIG. 6 is a top view thereof; and,
FIG. 7 is a bottom view thereof.
The broken line showing of certain features is for illustrative purposes only and forms no part of the claimed design.

1 Claim, 7 Drawing Sheets

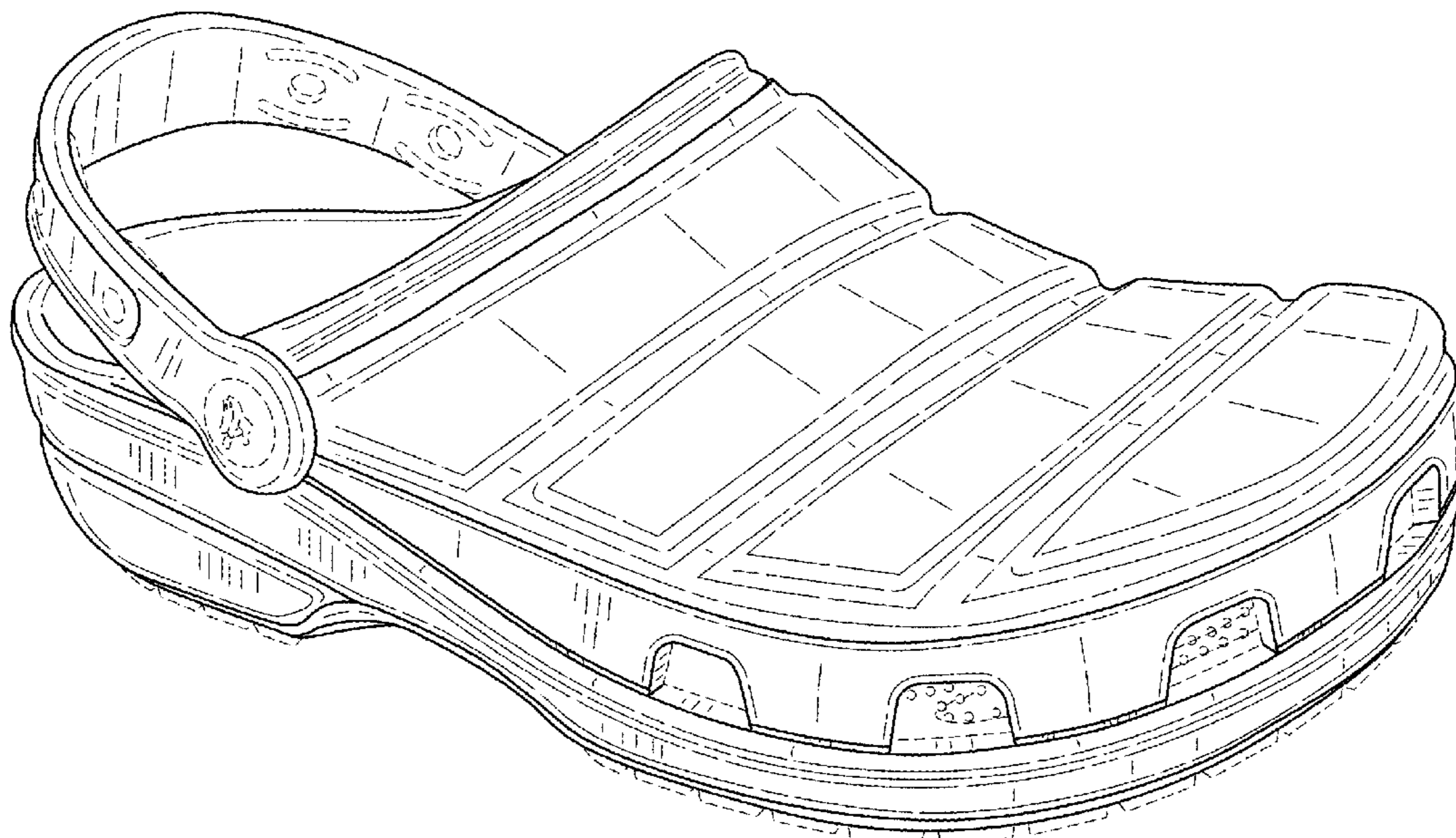

(56)

References Cited

U.S. PATENT DOCUMENTS

D728,204 S 5/2015 Fongher
 D731,157 S 6/2015 Fongher
 D732,806 S 6/2015 Maritan
 D732,808 S 6/2015 Del Biondi et al.
 D739,125 S 9/2015 Chanthavong
 D739,648 S 9/2015 Engerman
 D740,001 S 10/2015 Santos
 D741,053 S 10/2015 Fongher et al.
 D746,557 S 1/2016 Engerman
 D747,080 S 1/2016 Santos
 D762,953 S * 8/2016 Del Biondi D2/923
 D764,153 S 8/2016 Engerman
 D768,364 S 10/2016 Chanthavong et al.
 D771,917 S 11/2016 Del Biondi et al.
 D771,918 S 11/2016 Engerman
 D772,543 S 11/2016 Laska
 D787,789 S 5/2017 Del Biondi et al.
 D801,011 S 10/2017 Del Biondi et al.
 D821,079 S 6/2018 Abadjian
 D825,899 S 8/2018 Engerman
 D827,991 S 9/2018 Engerman et al.
 D830,674 S 10/2018 Thompson
 D833,124 S 11/2018 Laska
 D843,089 S * 3/2019 Chanthavong D2/916

D856,642 S 8/2019 Abadjian
 D869,826 S * 12/2019 Chanthavong D2/916
 D873,544 S 1/2020 Fongher et al.
 D874,797 S 2/2020 Fongher et al.
 D876,051 S 2/2020 Abadjian

OTHER PUBLICATIONS

Classic Clog, posted at Crocs.com, <https://www.crocs.com/p/classic-clog/10001.html?cgid=footwear&cid=3TI#start=1>, downloaded Dec. 23, 2020, (12 pages).
 Women's 1996 Retro Nuptse Jacket and Women's Morph Hoodie Products download, Internet Archive Wayback Machine, Jul. 26, 2018, <https://www.thenorthface.com/shop/womens-jackets-vests-insulated> (4 pages).
 Women's Winter Puff Boot, posted at Crocs.com, <https://www.crocs.com/p/womens-winter-puff-boot/14614-070-W8.html>, downloaded Jul. 10, 2020 (10 pages).
 Classic Transitional TPU Puff Cover Clog, printed Jan. 21, 2020 <https://crocs.centricsoftware.com/WebAccess/home.html#URL=C17126413&RURL=&Tab=Document> (1 page).
 Opposition dated May 27, 2020 to the registration of the Industrial Design titled: "Calzado" received in related Colombian Patent Application No. NC2020/0001094 (61 pages).

* cited by examiner

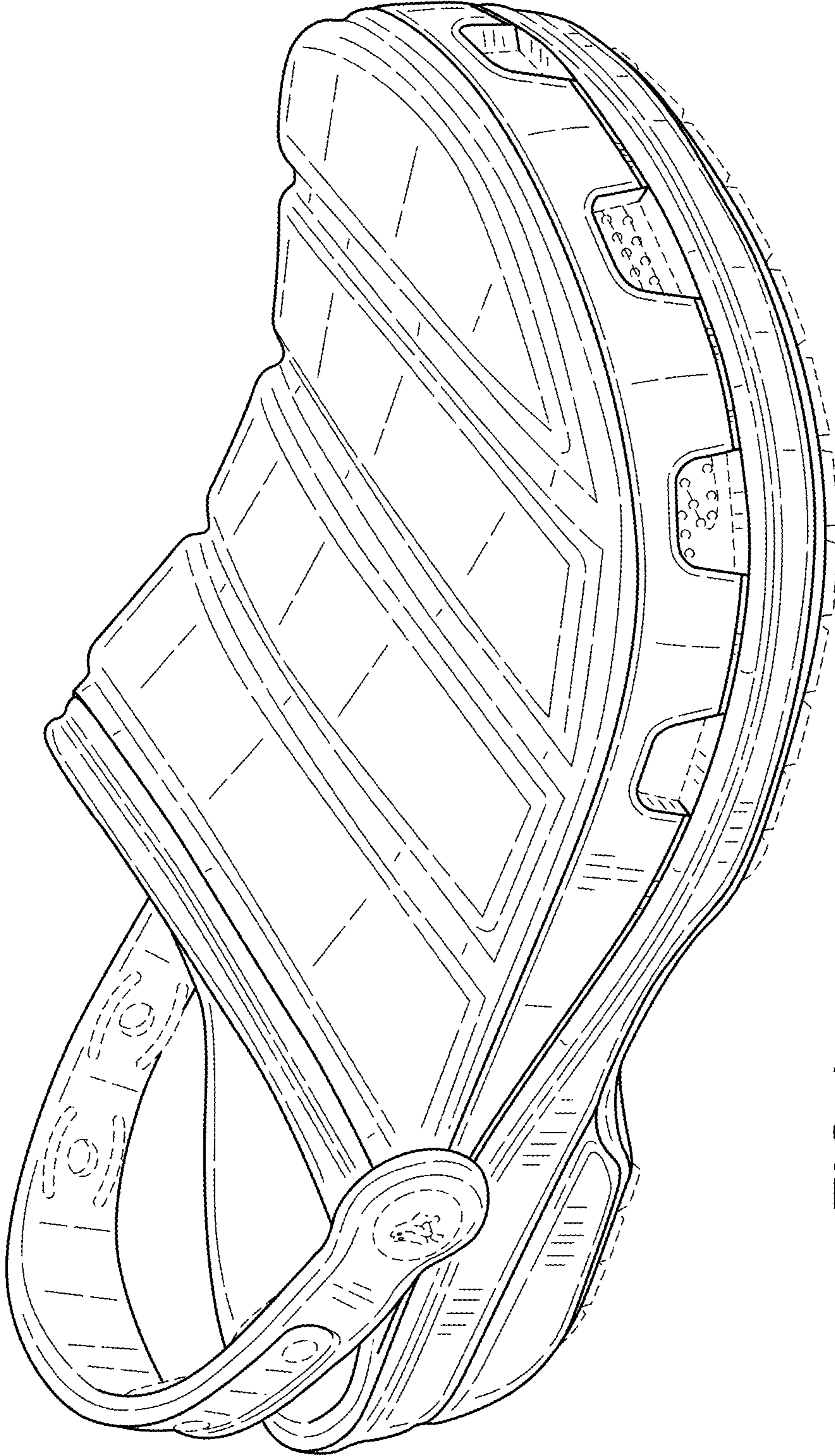

FIG.1

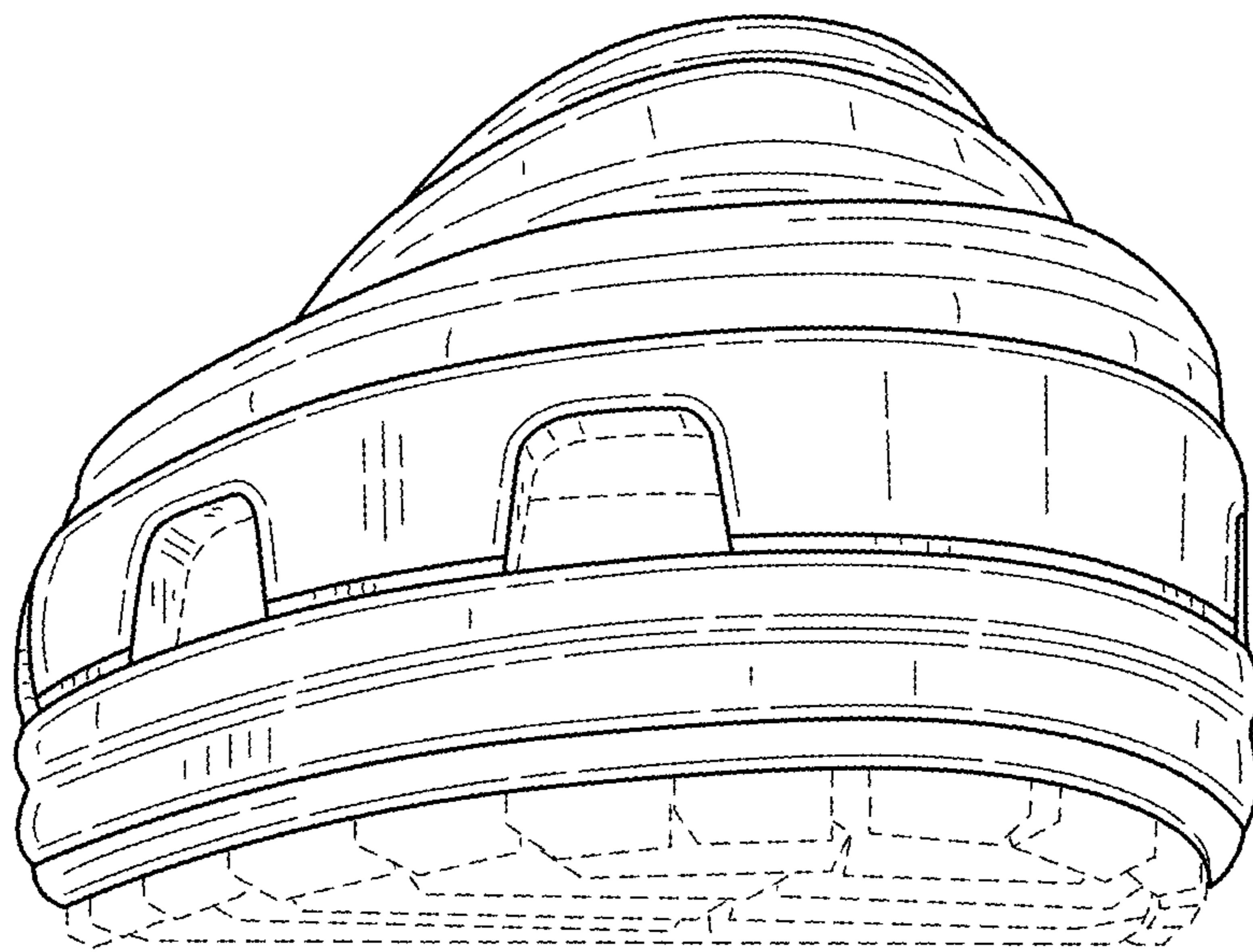

FIG.2

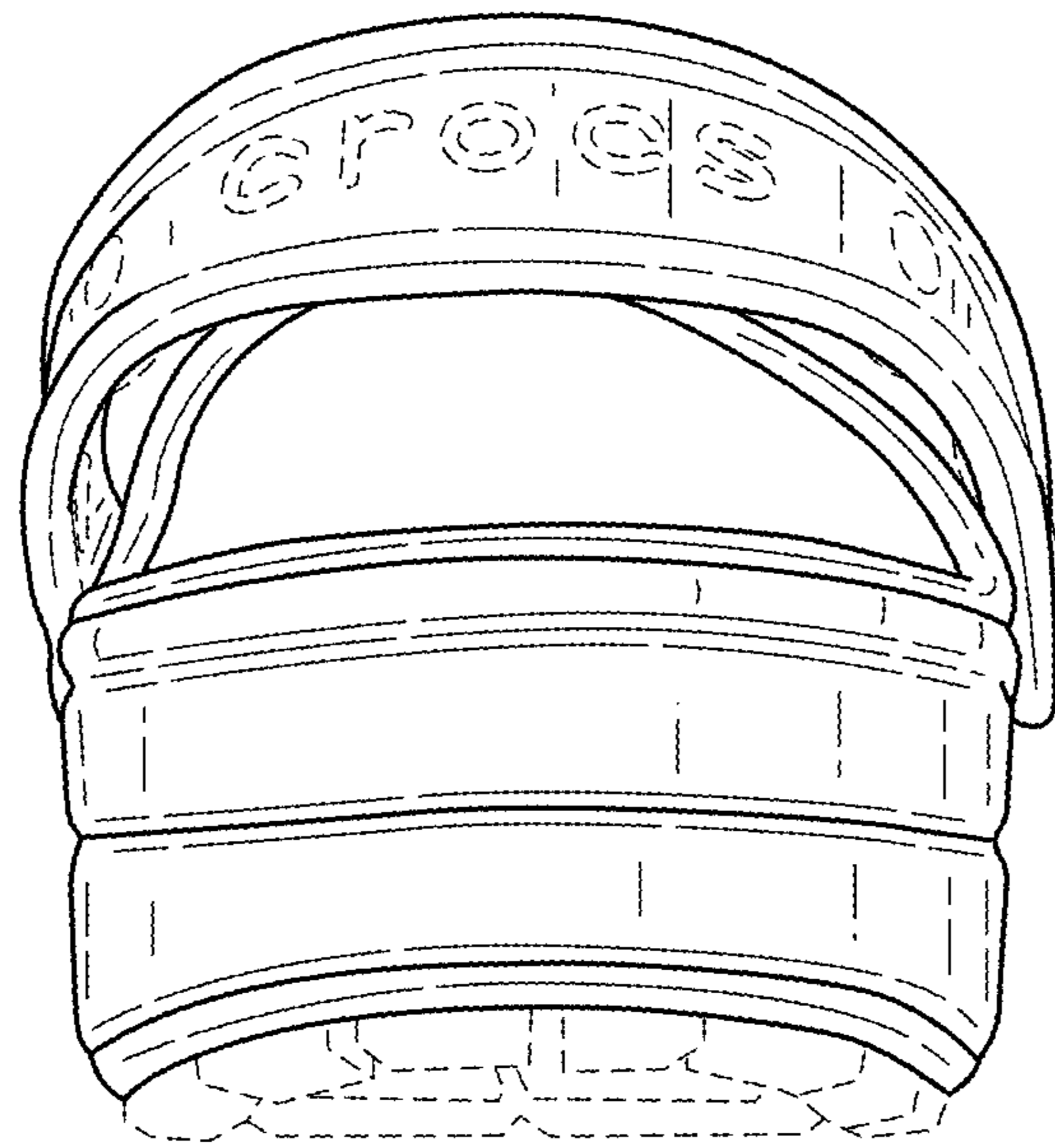

FIG.3

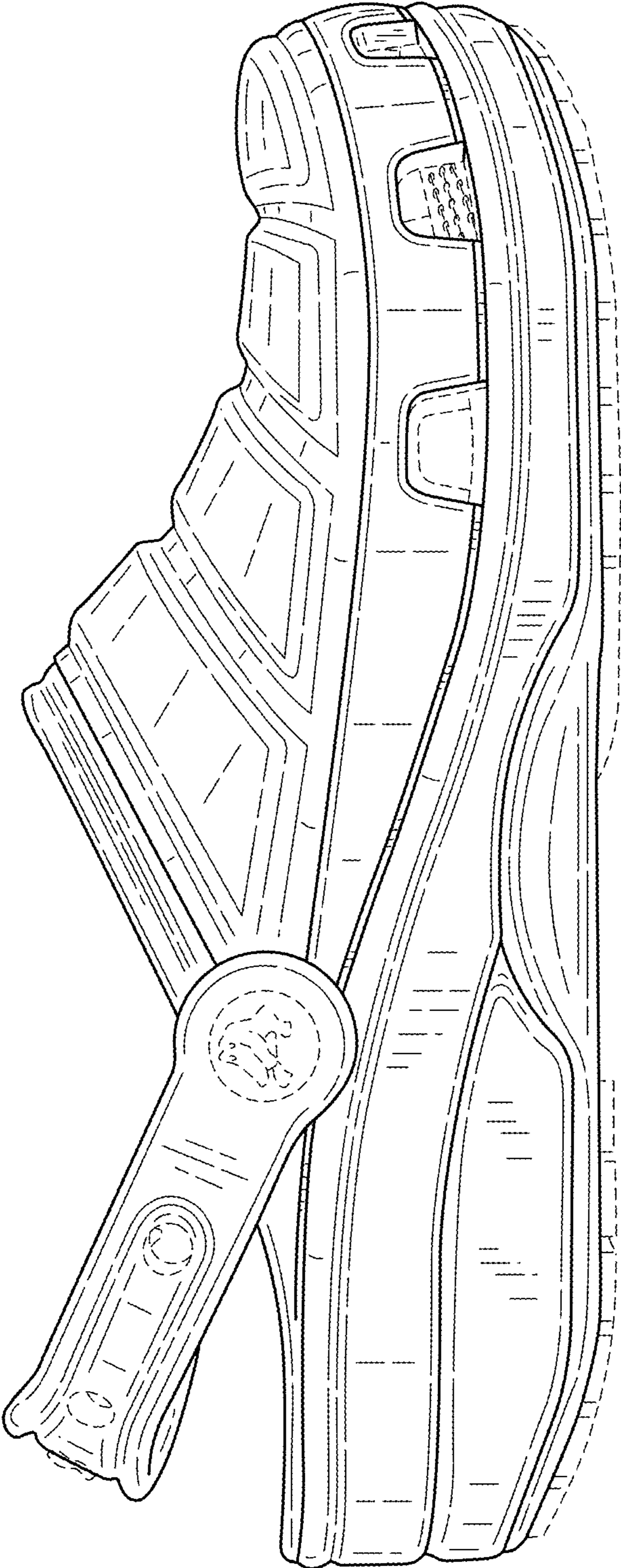

FIG.4

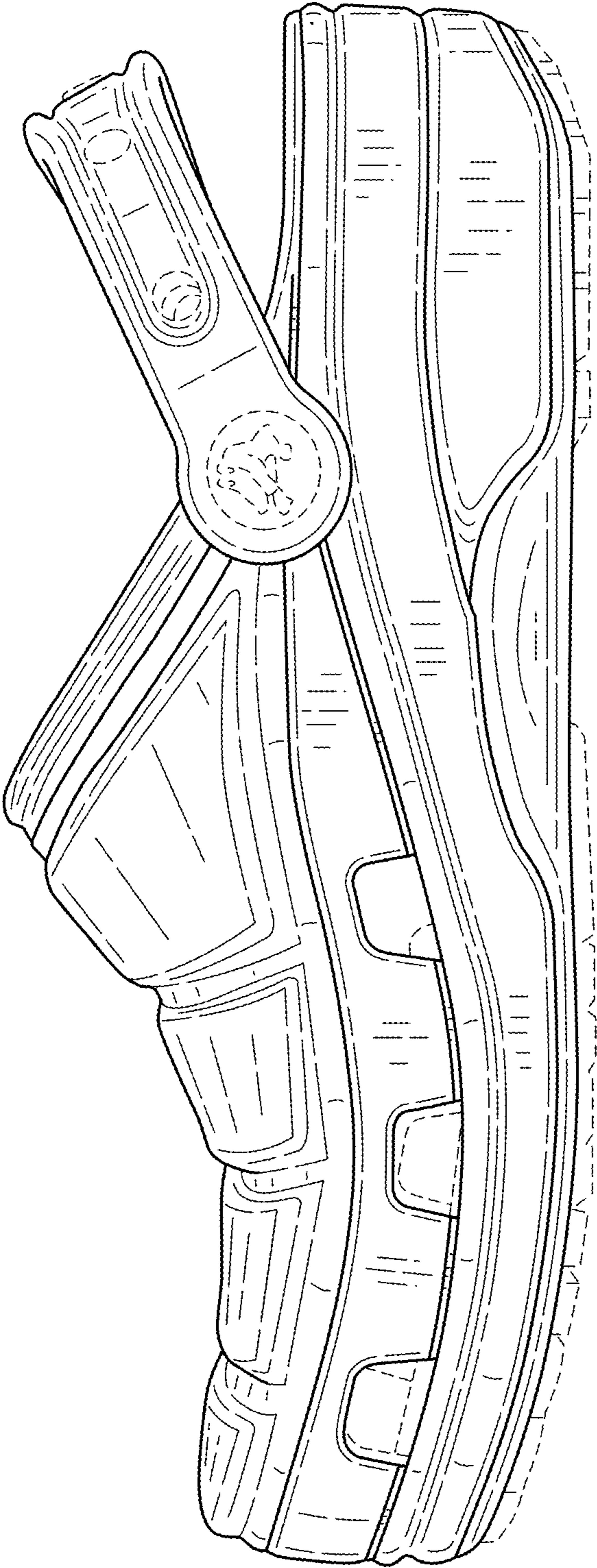

FIG.5

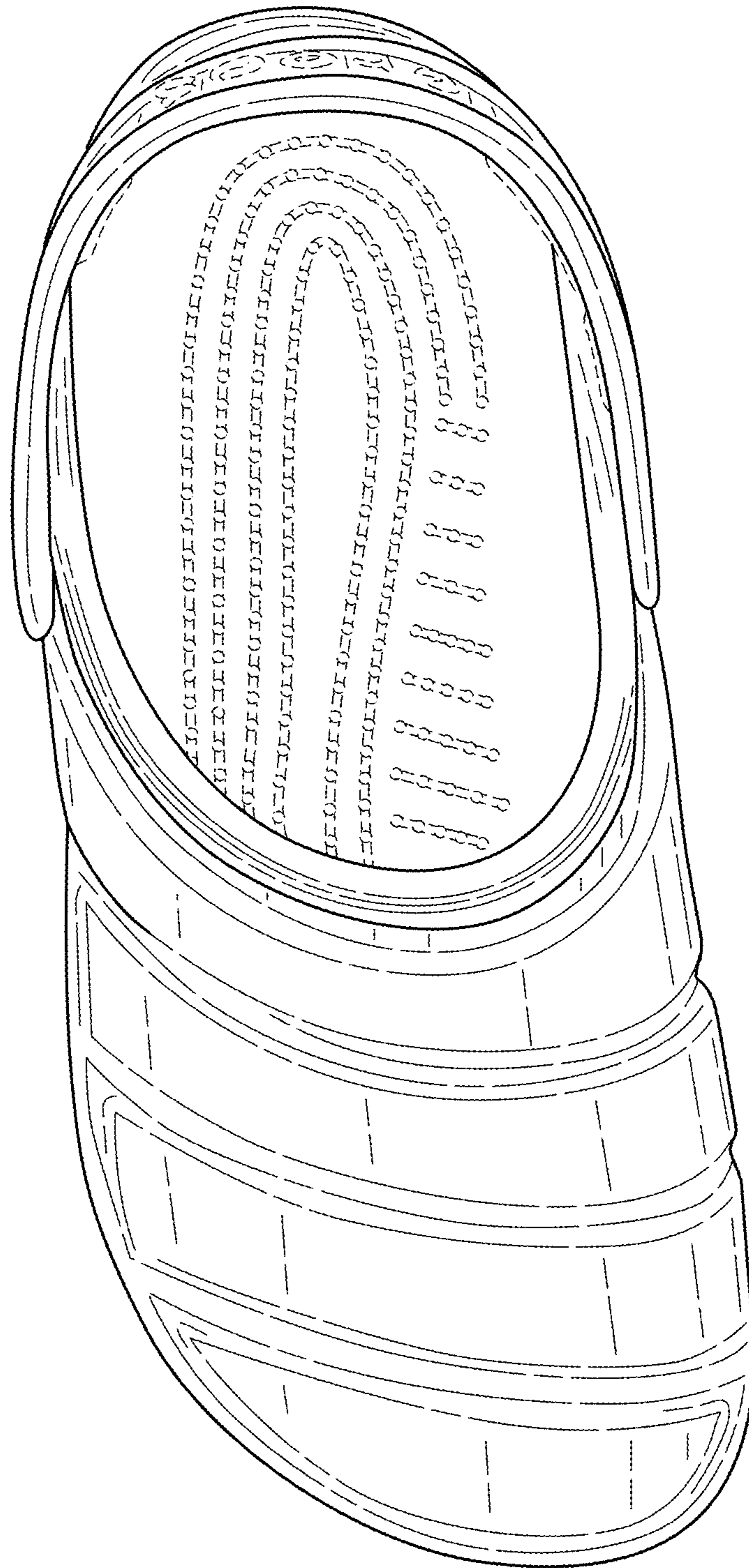

FIG.6

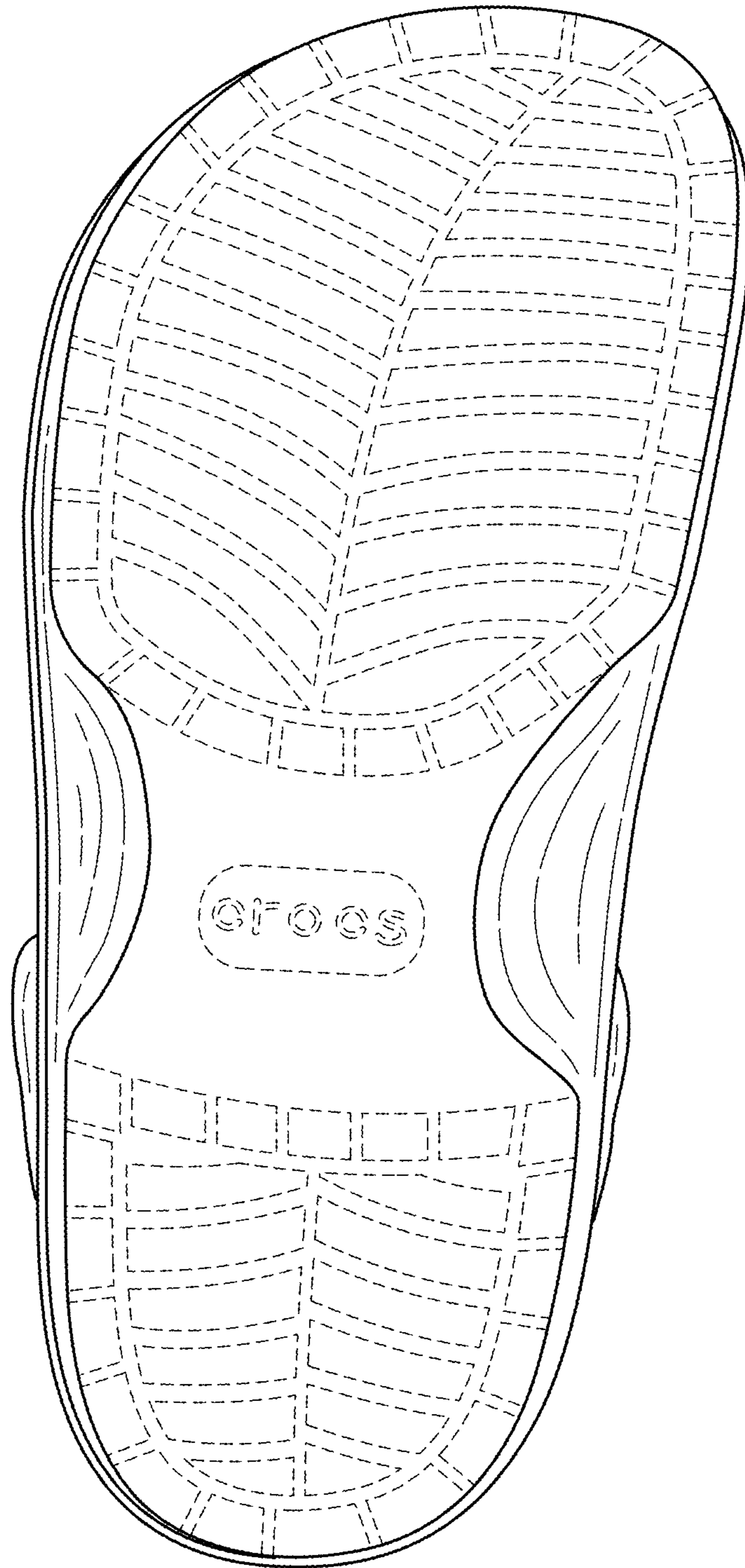

FIG. 7