



US00D919181S

(12) **United States Design Patent**
Kaminsky

(10) **Patent No.:** **US D919,181 S**
(45) **Date of Patent:** **** May 11, 2021**

(54) **STAR HAIR CLIP**

FOREIGN PATENT DOCUMENTS

(71) Applicant: **Sabrina Kaminsky**, Mill Valley, CA
(US)

EP 3656247 A1 * 5/2020 A45D 8/20

(72) Inventor: **Sabrina Kaminsky**, Mill Valley, CA
(US)

OTHER PUBLICATIONS

(**) Term: **15 Years**

Scunci No-Slip Grip Octopus Clip, reviewed on Oct. 18, 2014 on amazon.com, retrieved on Mar. 4, 2021, retrieved from the Internet URL: https://www.amazon.com/Scunci-No-Slip-Octopus-Tortoise-2-Count/dp/B001SXPSD2/ref=sr_1_46?dchild=1&keywords=claw%2Bhair%2Bclips&qid=1614884830&sr=8-46&th=1.*

(21) Appl. No.: **29/701,025**

* cited by examiner

(22) Filed: **Aug. 7, 2019**

(51) **LOC (13) Cl.** **28-03**

(52) **U.S. Cl.**
USPC **D28/40**

Primary Examiner — Catherine S Posthauer

Assistant Examiner — Alison M Ofstun

(58) **Field of Classification Search**
USPC D28/9, 10, 39-43, 99
CPC ... A45D 8/00; A45D 8/20; A45D 8/24; A45D
8/28; A45D 8/30; A45D 8/32; A45D 8/34
See application file for complete search history.

(74) *Attorney, Agent, or Firm* — Steven A. Nielsen;
www.NielsenPatents.com

(57) **CLAIM**

The ornamental design for a star hair clip, as shown and described.

(56) **References Cited**

DESCRIPTION

U.S. PATENT DOCUMENTS

D428,670 S *	7/2000	Tsai	D28/40
D627,099 S *	11/2010	Tu	D28/40
D719,297 S *	12/2014	Hsu	A45D 8/24
				D28/40
D769,525 S *	10/2016	Coral	D28/40
D769,526 S *	10/2016	Coral	D28/40
D898,996 S *	10/2020	Kaminsky	D28/40
D904,690 S *	12/2020	Kaminsky	D28/40
2004/0231692 A1 *	11/2004	Shyu	A45D 8/20
				132/277
2008/0149129 A1 *	6/2008	Yang	A45D 8/20
				132/277
2008/0216862 A1 *	9/2008	Silva	A45D 8/20
				132/277
2009/0272397 A1 *	11/2009	Defenbaugh	A45D 8/20
				132/277
2009/0272398 A1 *	11/2009	Chudzik	A45D 8/20
				132/277
2020/0288837 A1 *	9/2020	Tu	A45D 8/22
2021/0022469 A1 *	1/2021	Freeman	A45D 8/20

FIG. 1 is a back and side perspective view of a star hair clip showing my new design;
FIG. 2 is a back view thereof;
FIG. 3 is a front view thereof;
FIG. 4 is a right side view thereof;
FIG. 5 is a left side view thereof;
FIG. 6 is a bottom view thereof;
FIG. 7 is a top view thereof;
FIG. 8 is a back and side perspective view in an open position thereof;
FIG. 9 is a back view in an open position thereof;
FIG. 10 is a front view in an open position thereof;
FIG. 11 is a right side view in an open position thereof;
FIG. 12 is a left side view in an open position thereof;
FIG. 13 is a bottom view in an open position thereof; and,
FIG. 14 is a top view in an open position thereof.

1 Claim, 11 Drawing Sheets

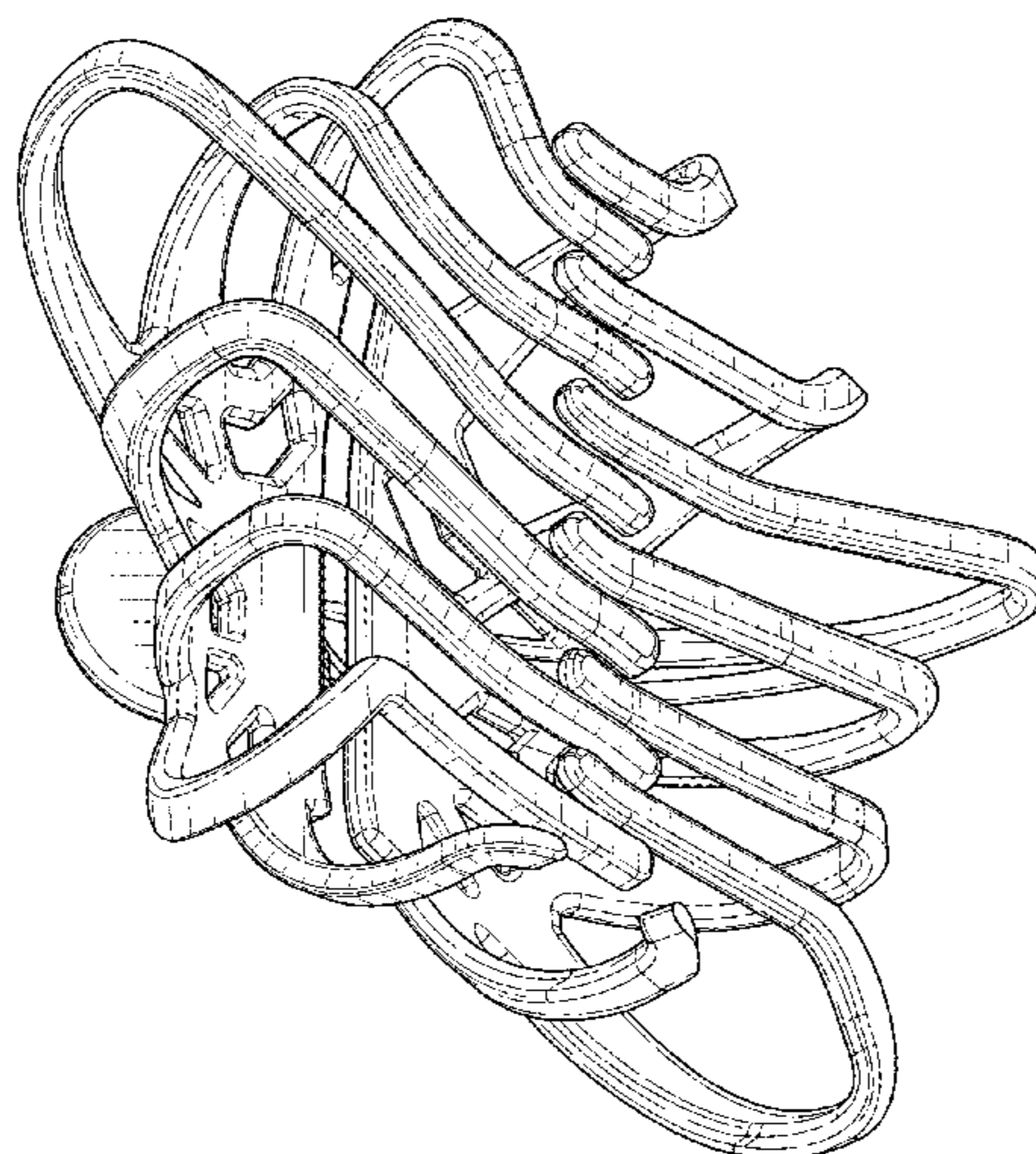

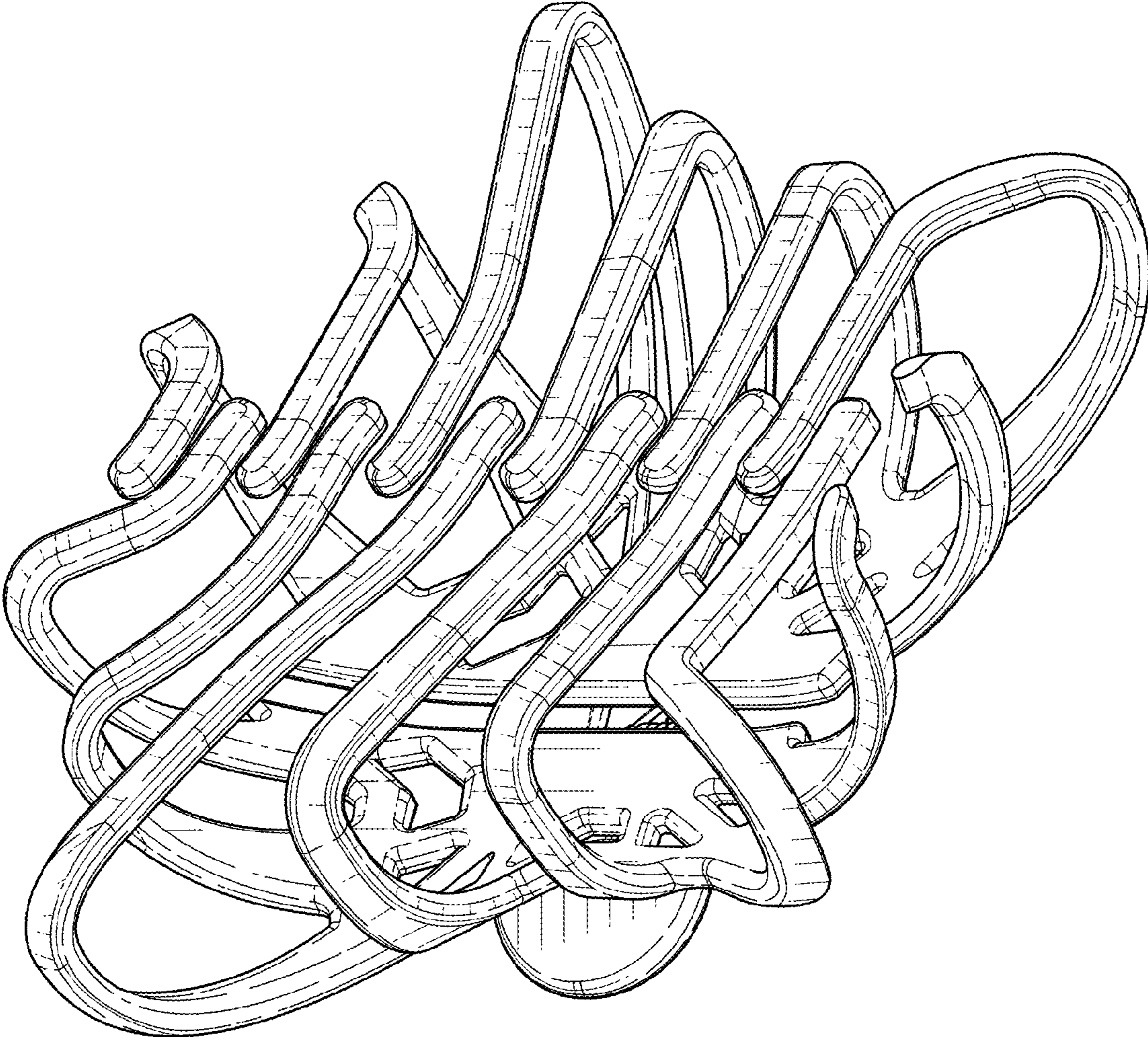

FIG. 1

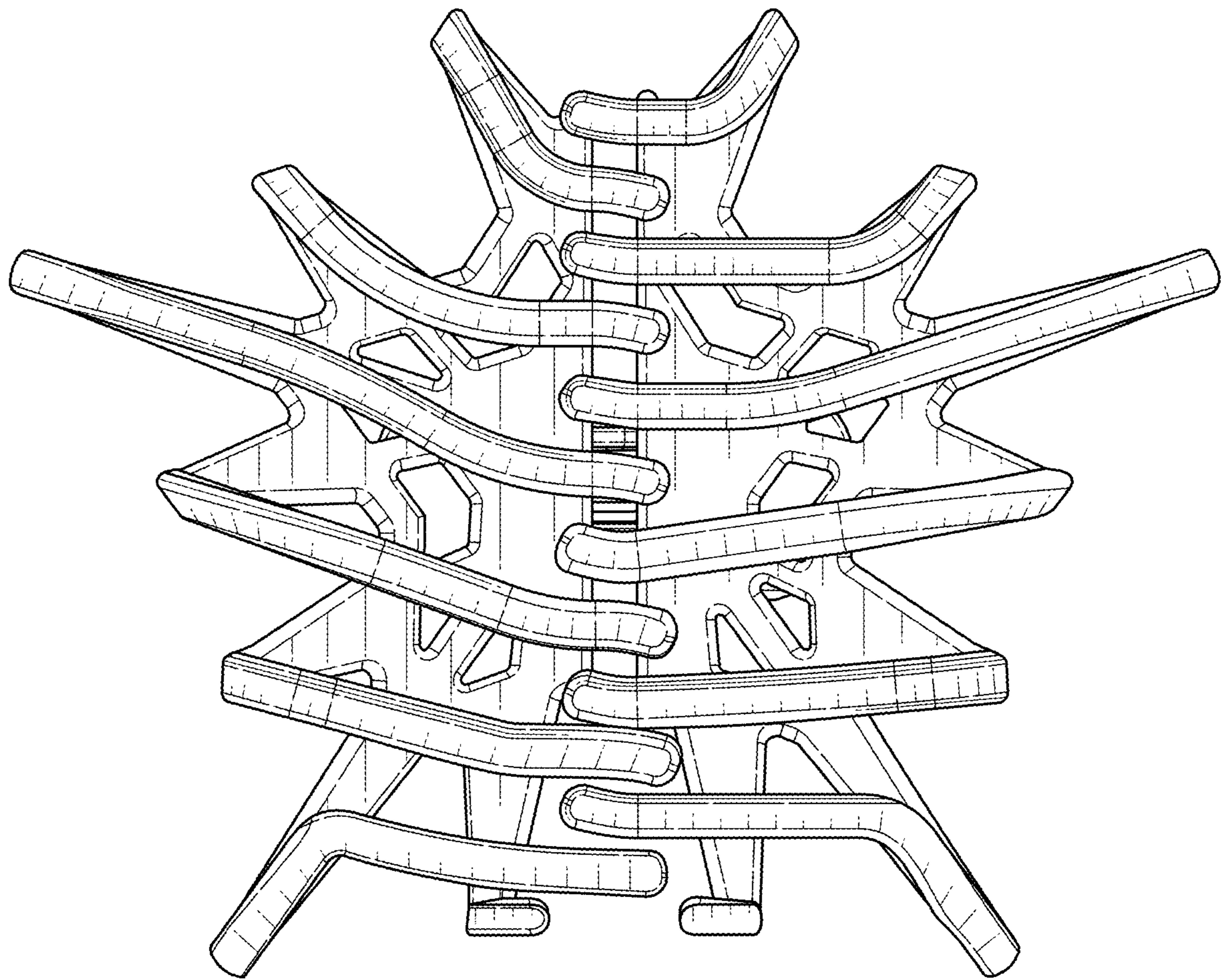

FIG. 2

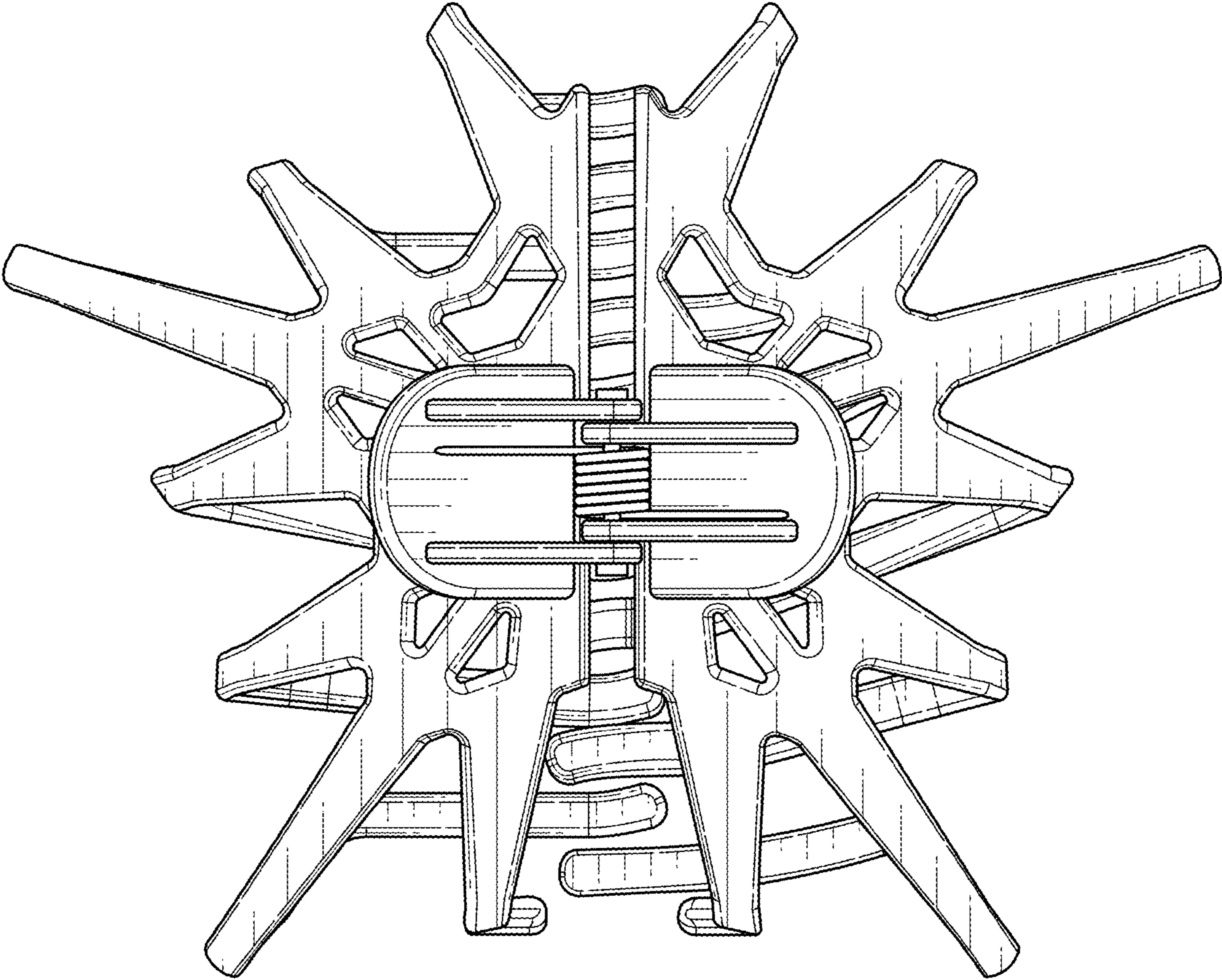

FIG. 3

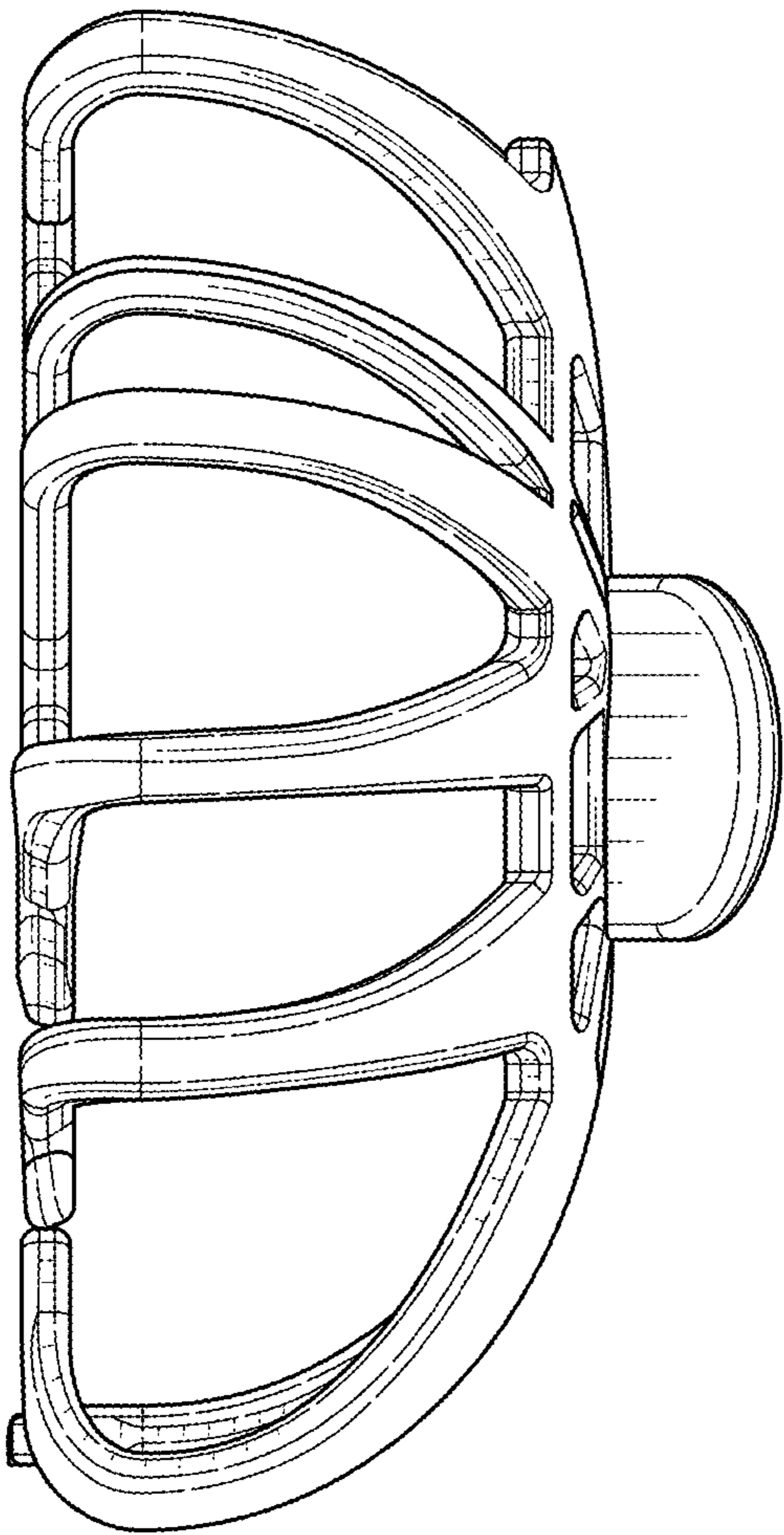

FIG. 4

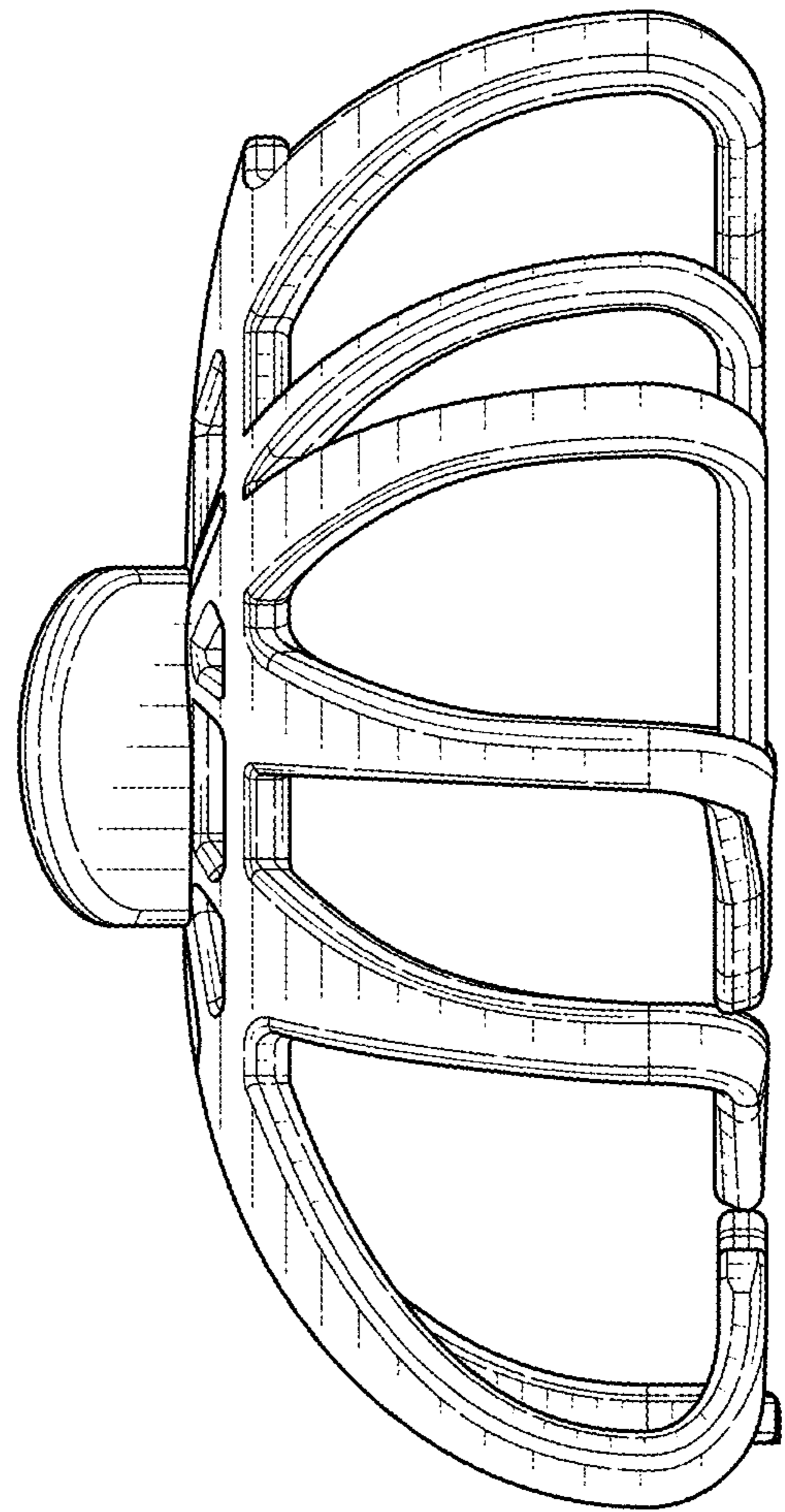

FIG. 5

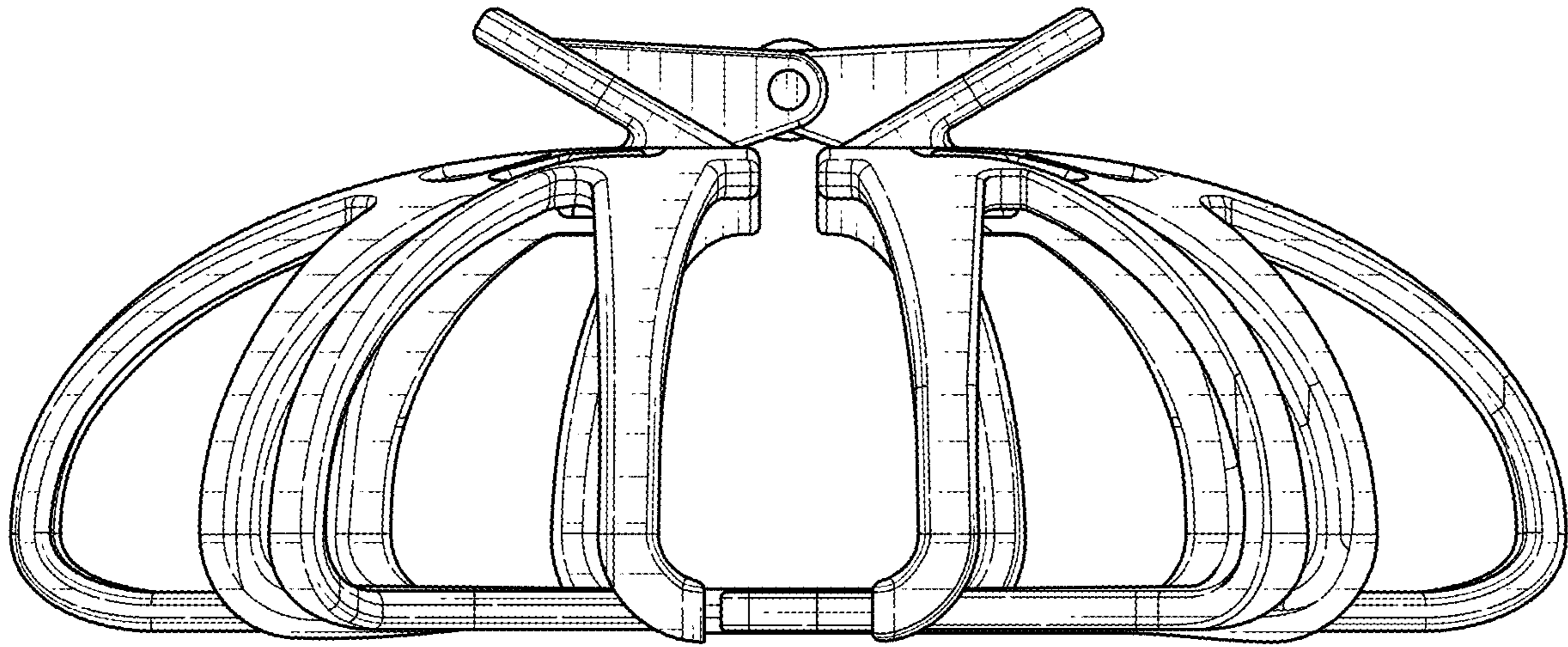

FIG. 6

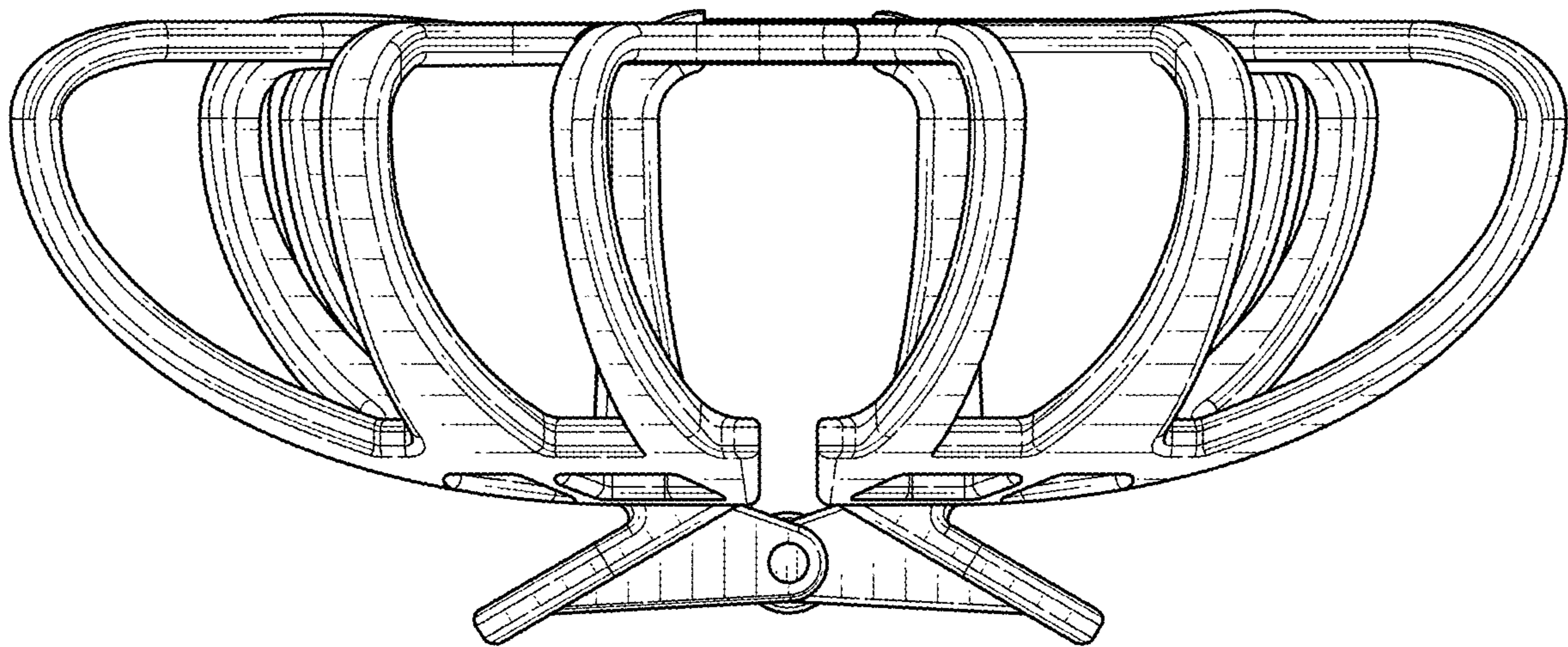

FIG. 7

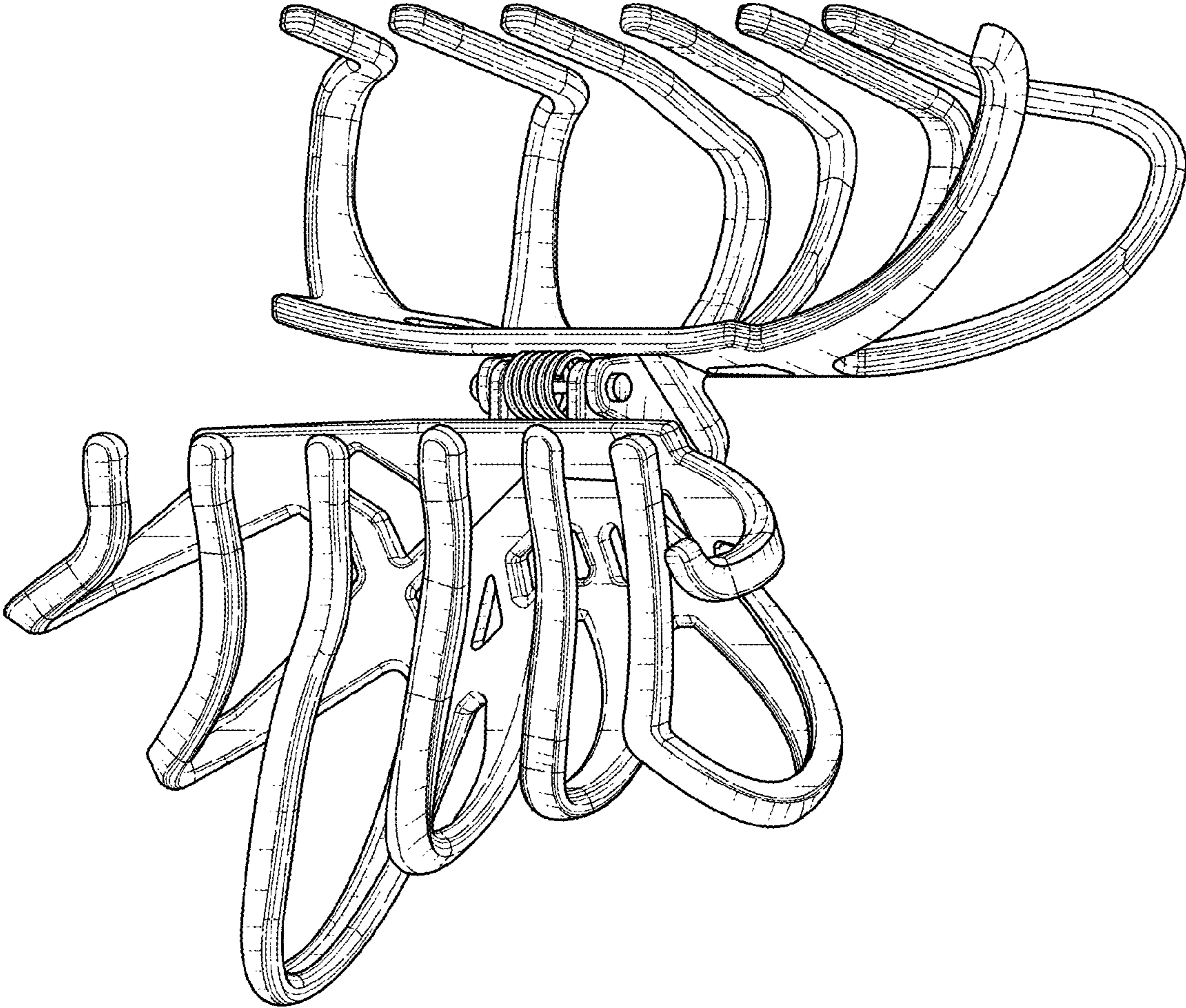

FIG. 8

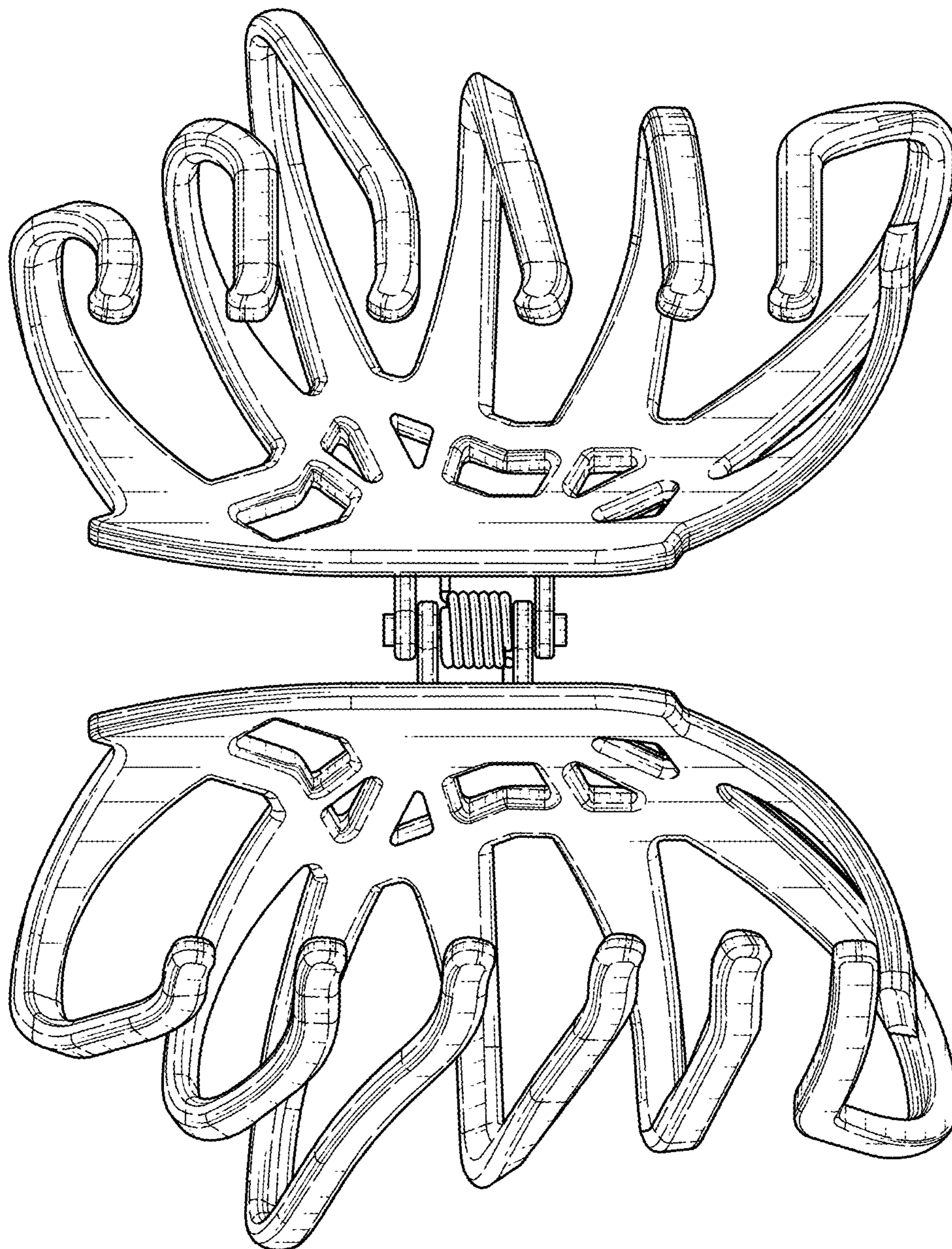

FIG. 9

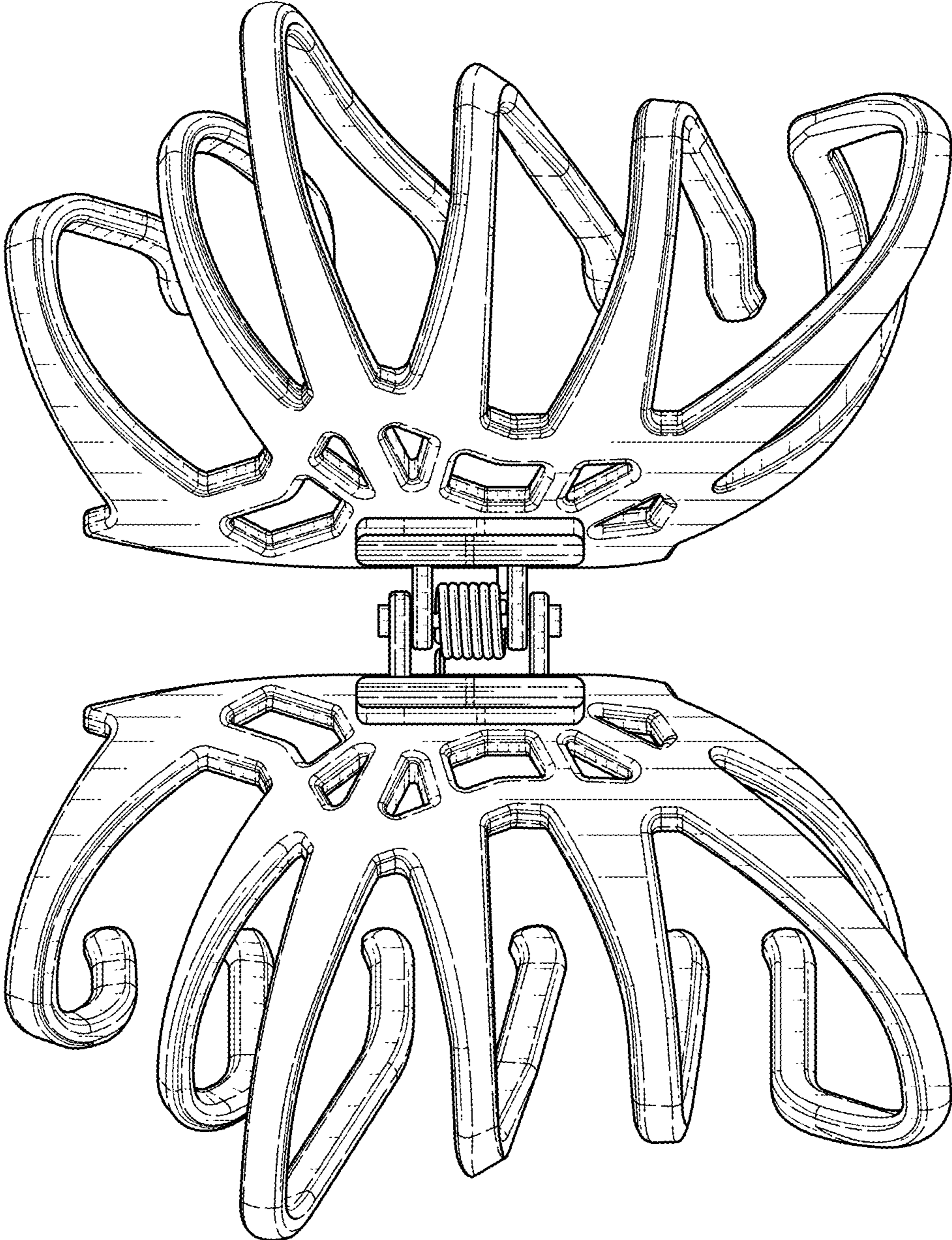

FIG. 10

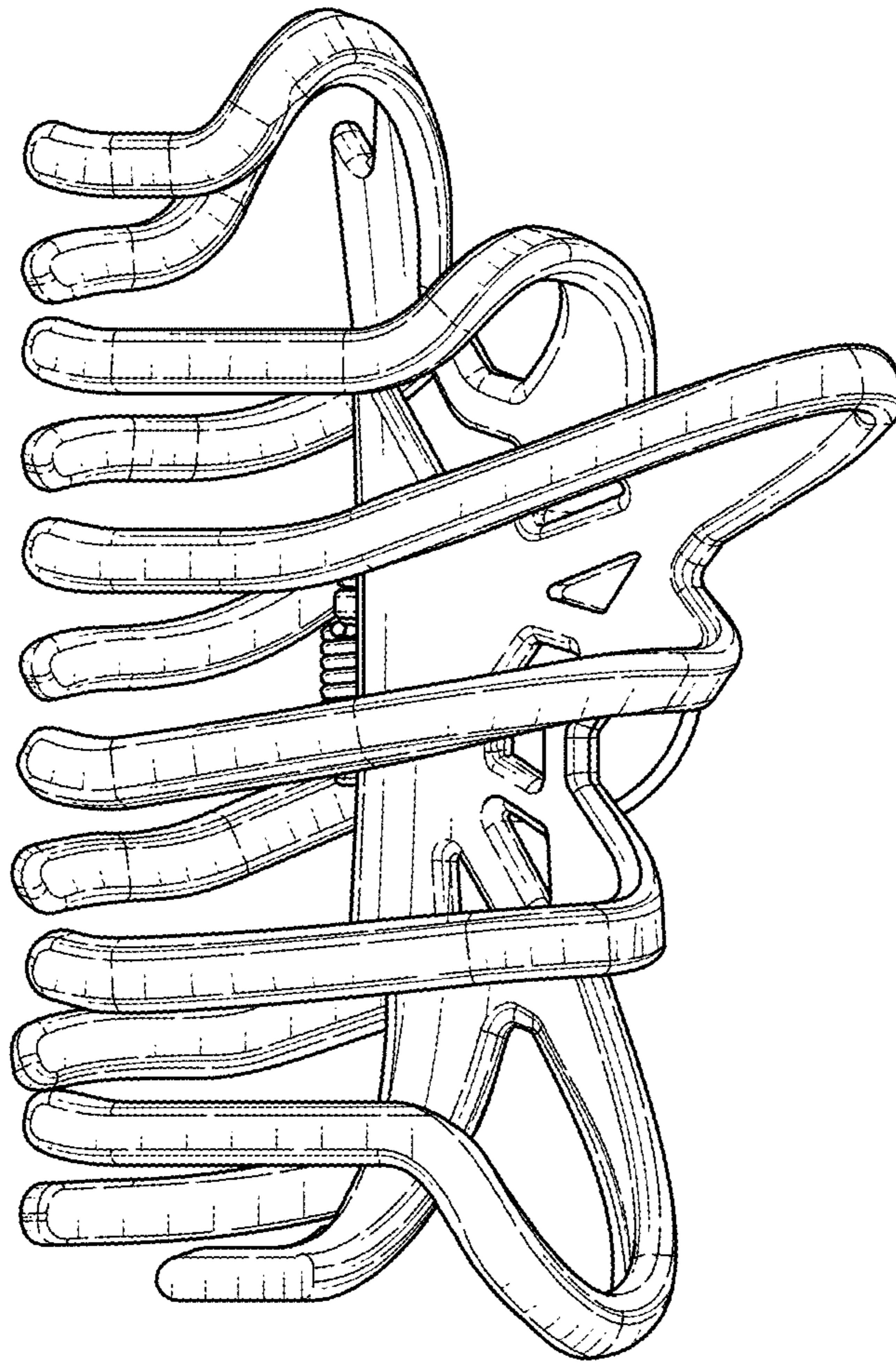

FIG. 11

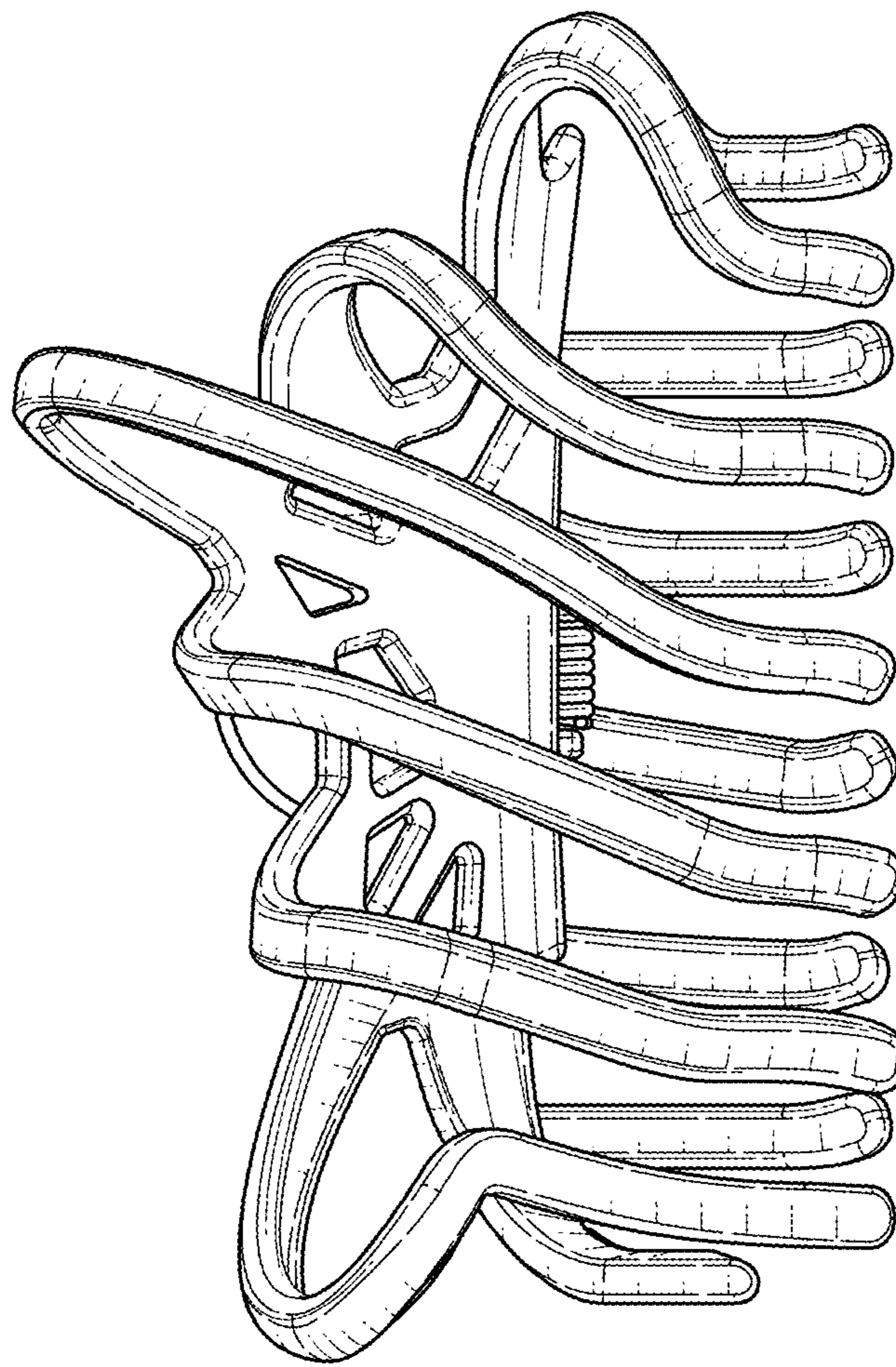

FIG. 12

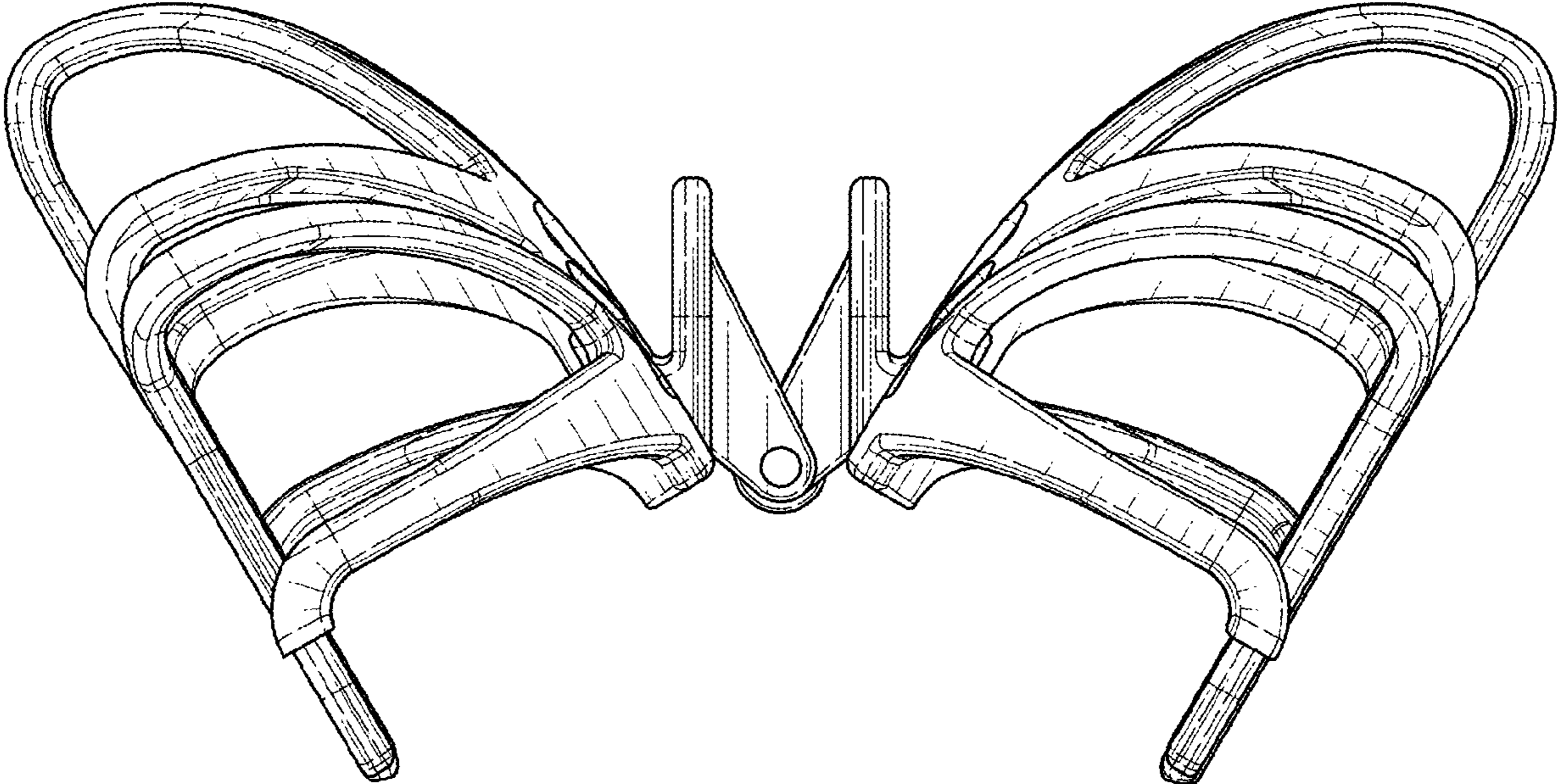

FIG. 13

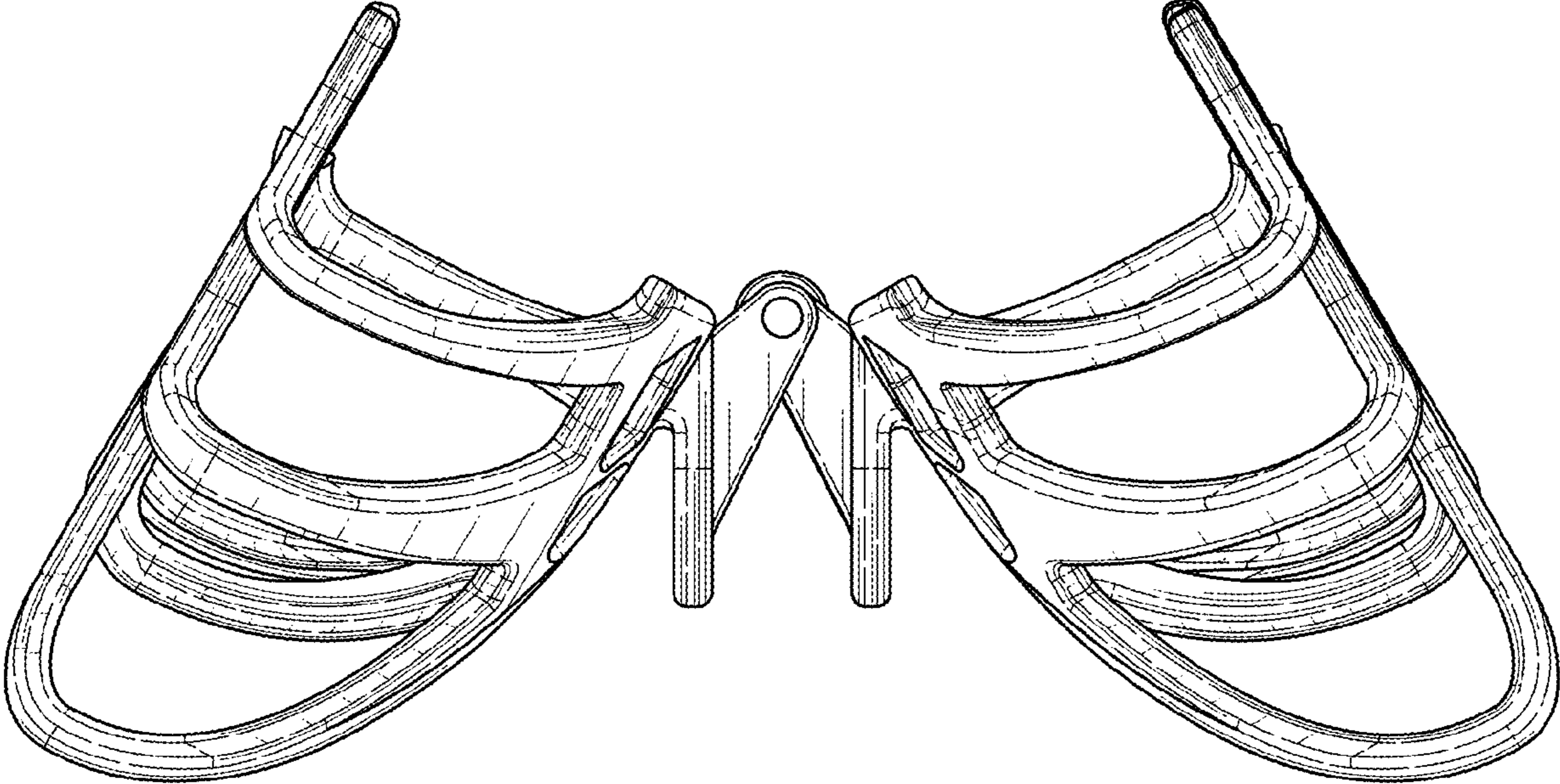

FIG. 14