



US00D919167S

(12) **United States Design Patent** (10) **Patent No.:** **US D919,167 S**
Gomez Martinez (45) **Date of Patent:** **** May 11, 2021**

- (54) **ADJUSTABLE TRANSITION MOUNT**
- (71) Applicant: **Nicor, Inc.**, Albuquerque, NM (US)
- (72) Inventor: **Jorge Alfredo Gomez Martinez**,
Albuquerque, NM (US)
- (73) Assignee: **NICOR, INC.**, Albuquerque, NM (US)
- (**) Term: **15 Years**
- (21) Appl. No.: **29/710,367**
- (22) Filed: **Oct. 22, 2019**
- (51) **LOC (13) Cl.** **26-05**
- (52) **U.S. Cl.**
USPC **D26/138**
- (58) **Field of Classification Search**
USPC D26/76, 78, 79, 80, 81, 82, 83, 85, 86,
D26/88, 90, 113, 118, 119, 120, 121, 122,
D26/138, 139, 140, 141, 142; D8/354,
D8/323
CPC F21S 2/00; F21S 4/00; F21S 4/003; F21S
4/005; F21S 4/006; F21S 4/007; F21S
4/008; F21S 6/00; F21S 8/00; F21S
8/024; F21S 8/026; F21S 8/031; F21S
8/033; F21S 8/035-037; F21S 8/04; F21S
8/043; F21S 8/063
See application file for complete search history.

(56) **References Cited**

U.S. PATENT DOCUMENTS

- 4,550,852 A * 11/1985 Laudt H05K 5/0008
220/327
- 5,062,029 A * 10/1991 Engel F21V 23/02
362/287
- 5,249,108 A * 9/1993 Gary F21V 21/14
248/231.9
- 6,409,411 B1 * 6/2002 Corey B25J 15/0052
403/54
- 7,014,339 B2 * 3/2006 Sears, Jr. F21S 8/086
362/265
- D557,586 S * 12/2007 Shire D8/327

- D695,593 S * 12/2013 Nunez Farfan D8/354
- D698,628 S * 2/2014 Stanley D8/367
- D761,078 S * 7/2016 Schweiss D8/323
- D808,244 S * 1/2018 Fraijo D8/327
- D809,894 S * 2/2018 Schweiss D8/323
- D811,195 S * 2/2018 Wang D8/323
- D813,009 S * 3/2018 Lindo D8/323
- 10,309,584 B2 * 6/2019 Johnson F16B 2/065
- D863,043 S * 10/2019 Schweiss D8/356

(Continued)

Primary Examiner — Michael C Stout
Assistant Examiner — Benjamin M Weeks
(74) *Attorney, Agent, or Firm* — Loza & Loza LLP;
Kevin L. Soules

(57) **CLAIM**

The ornamental design for an adjustable transition mount, as shown and described.

DESCRIPTION

FIG. 1 is a top right perspective of an adjustable transition mount, according to the present invention.
FIG. 2 is a top left perspective of the adjustable transition mount of FIG. 1;
FIG. 3 is a bottom left perspective of the adjustable transition mount of FIG. 1;
FIG. 4 is a left side elevation view of the adjustable transition mount of FIG. 1;
FIG. 5 is a right side elevation view of the adjustable transition mount of FIG. 1;
FIG. 6 is a front elevation view of the adjustable transition mount of FIG. 1;
FIG. 7 is a back elevation view of the adjustable transition mount of FIG. 1;
FIG. 8 is a top plan view of the adjustable transition mount of FIG. 1; and,
FIG. 9 is a bottom plan view of the adjustable transition mount of FIG. 1.

1 Claim, 8 Drawing Sheets

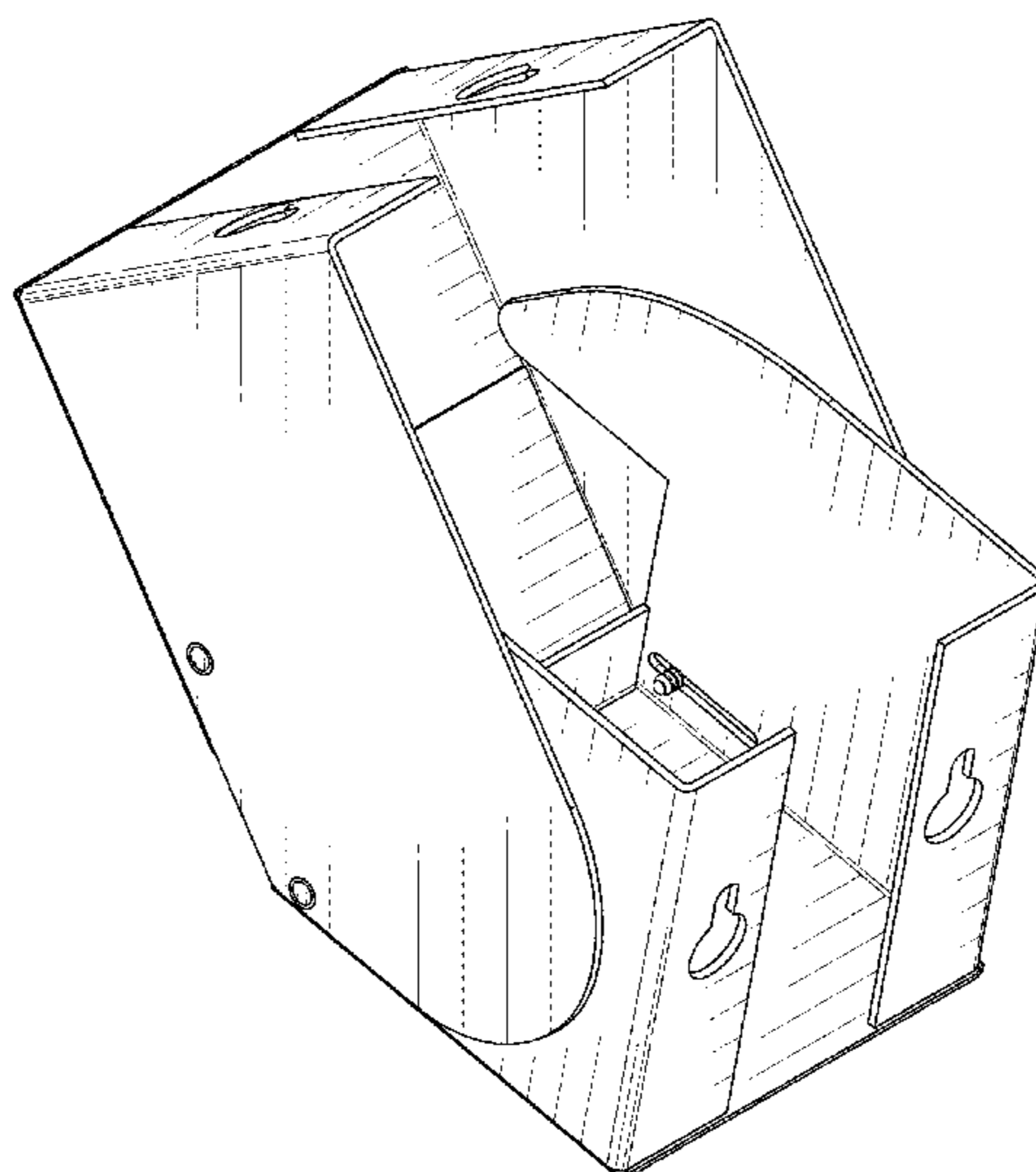

(56)

References Cited

U.S. PATENT DOCUMENTS

D871,196 S * 12/2019 Schweiss D8/356
2015/0219295 A1* 8/2015 Clark F21V 21/042
362/396
2016/0356415 A1* 12/2016 Moore F16M 11/08

* cited by examiner

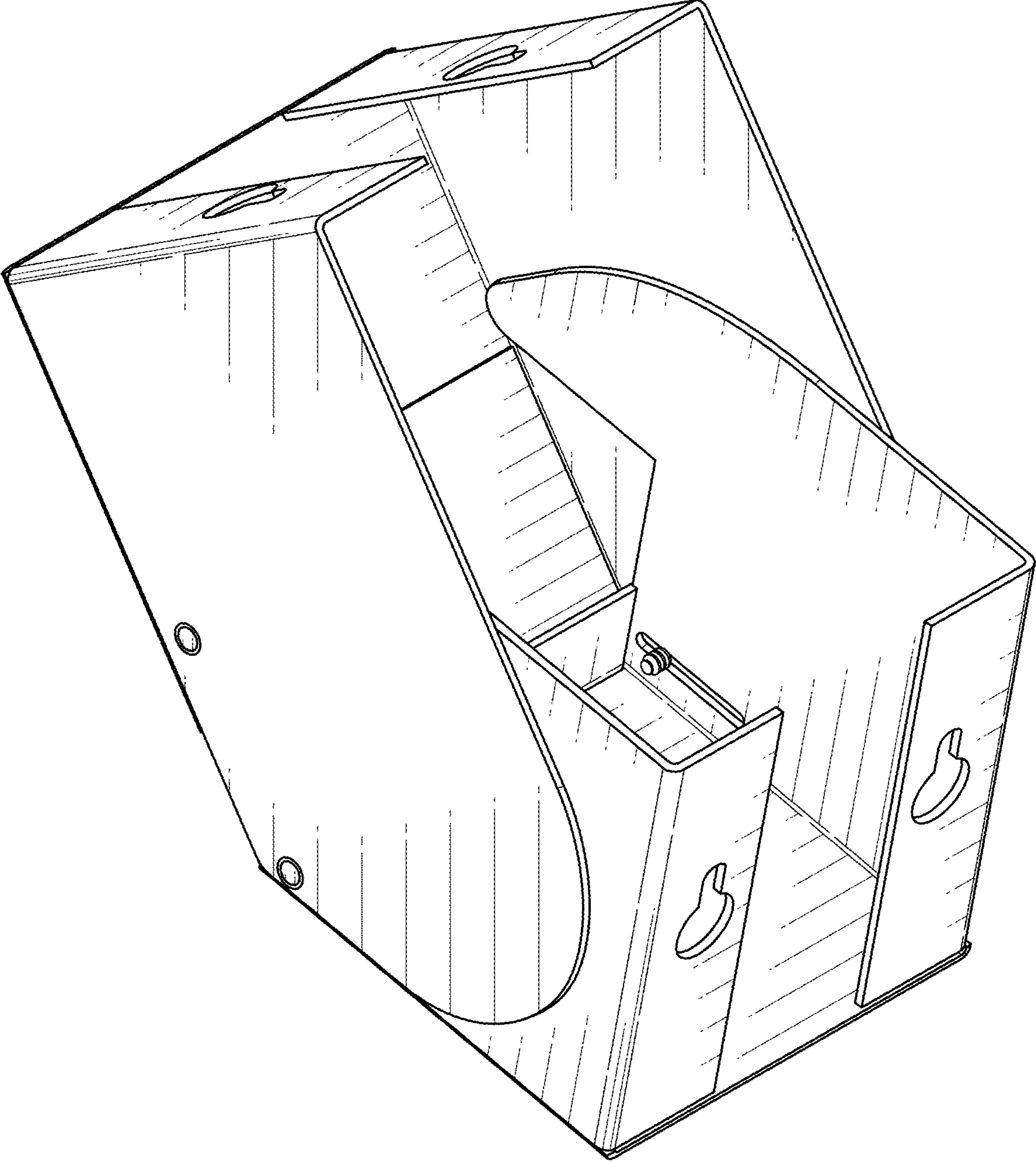

FIG. 1

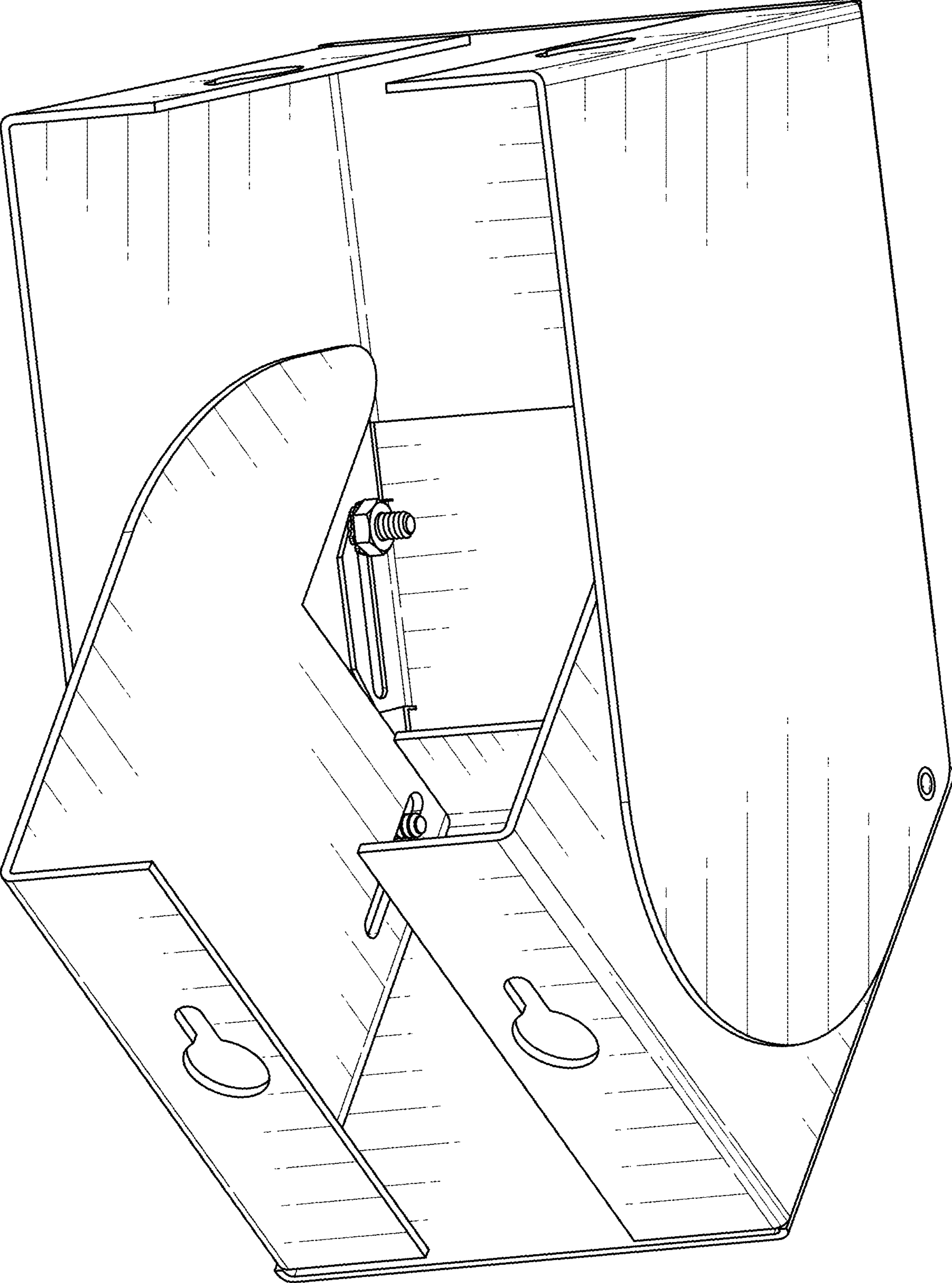

FIG. 2

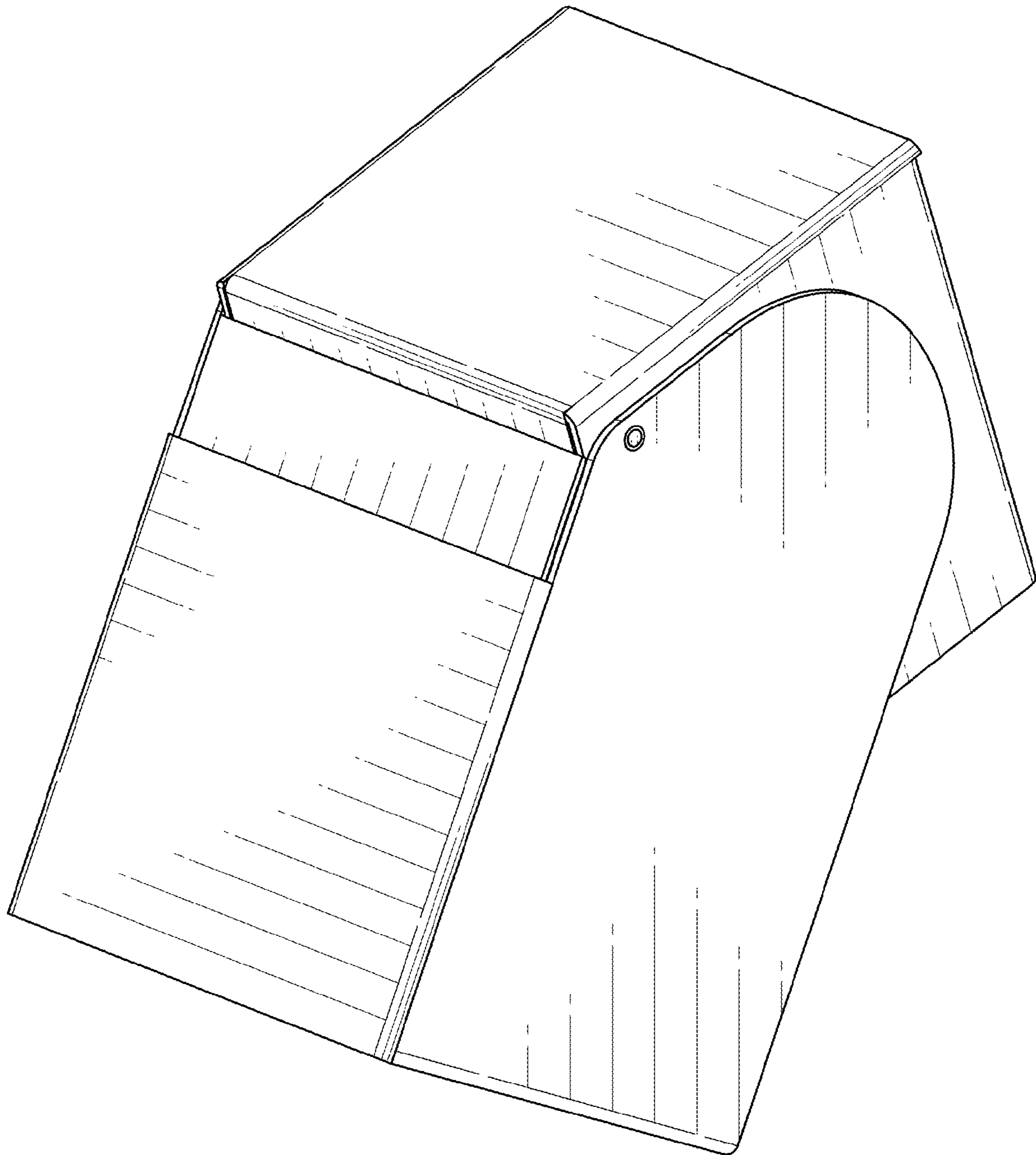

FIG. 3

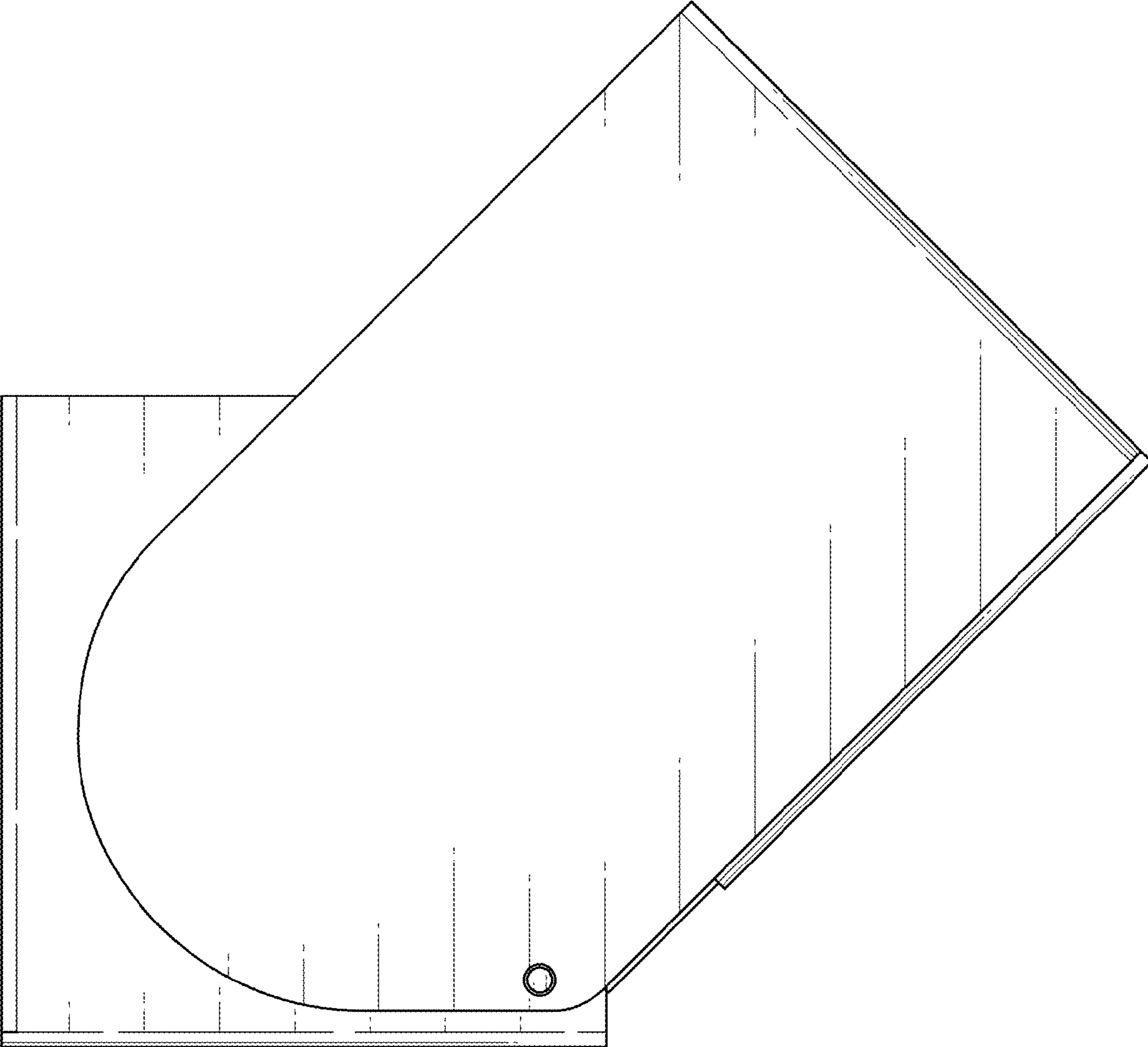

FIG. 4

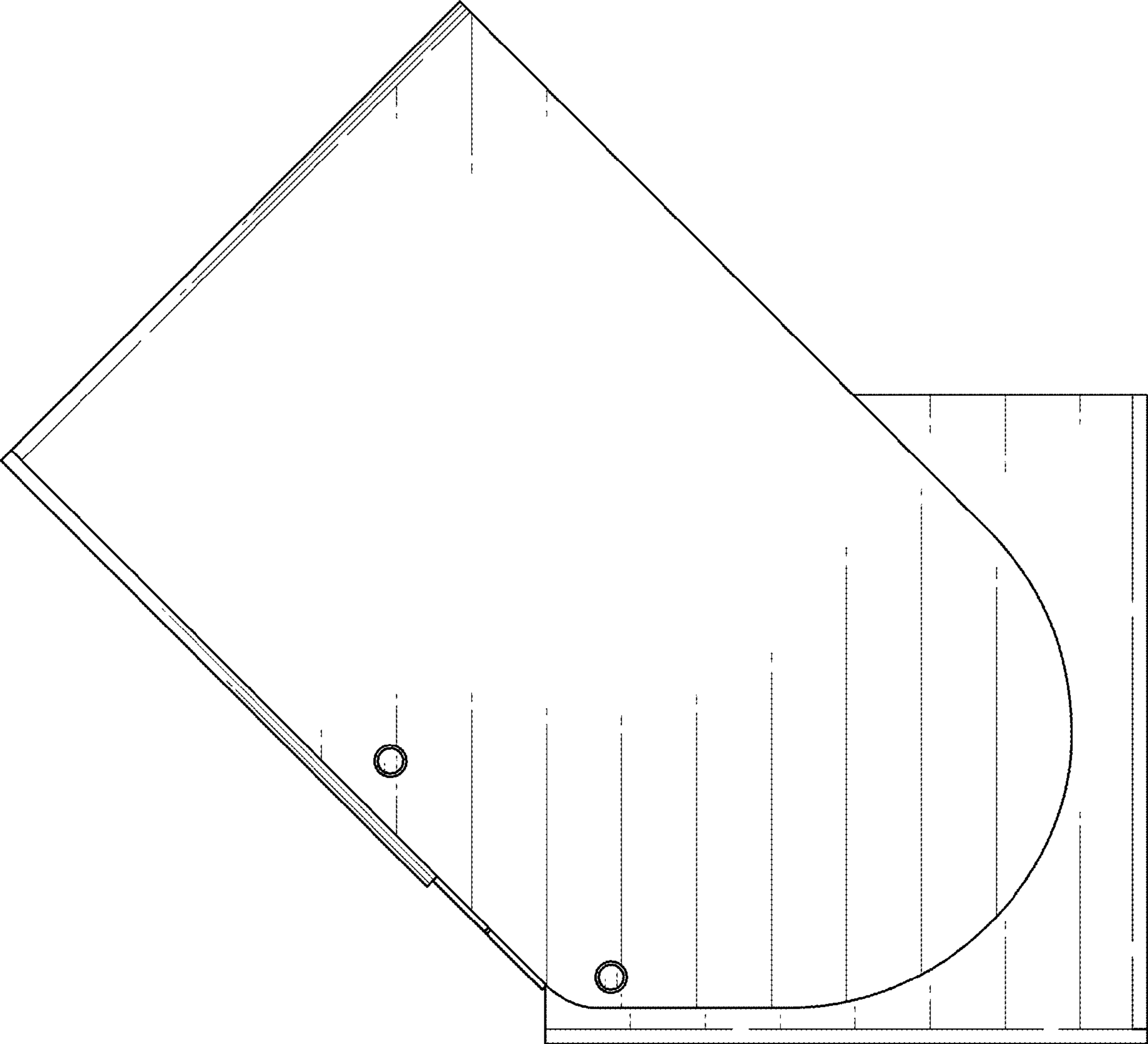

FIG. 5

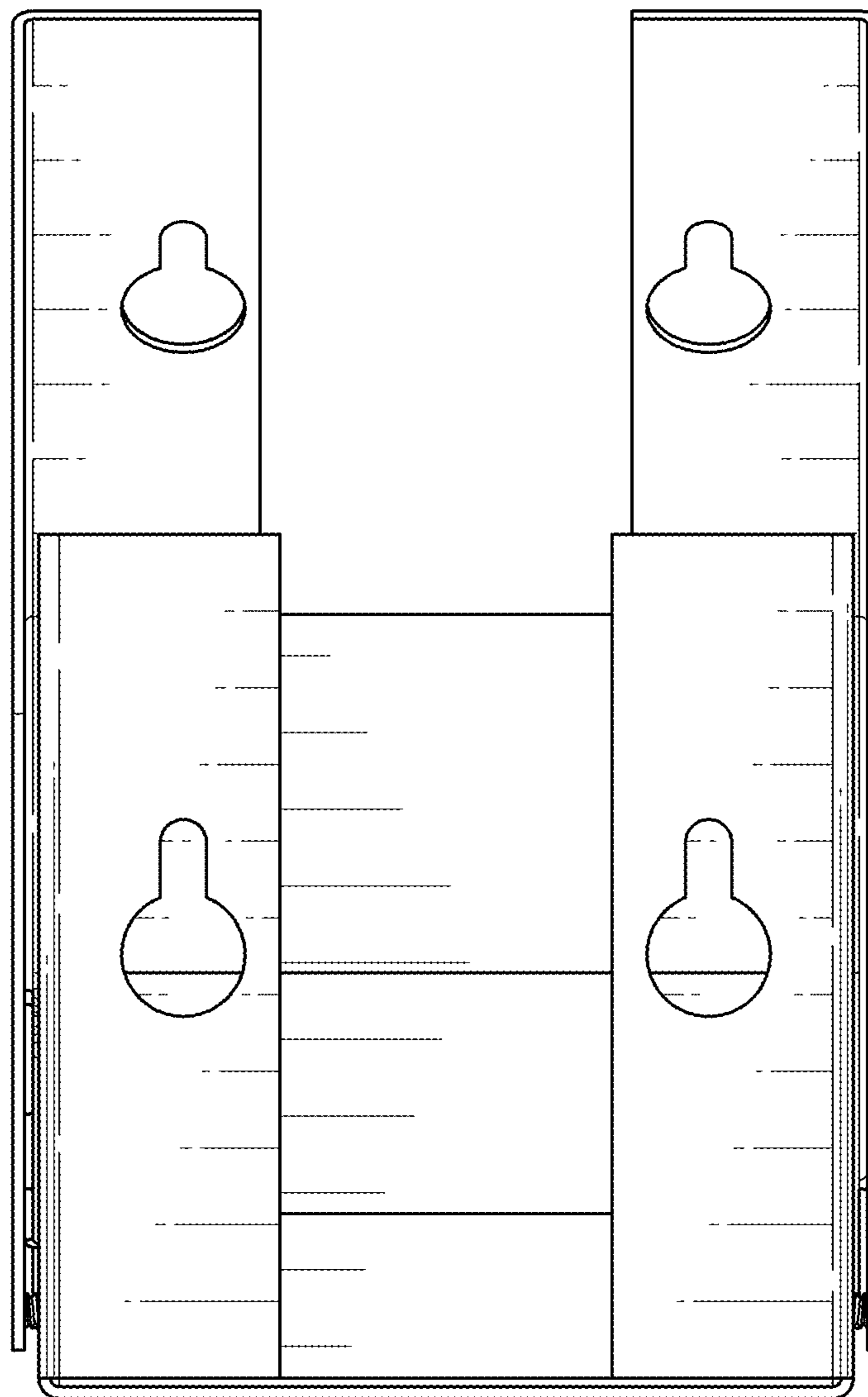

FIG. 6

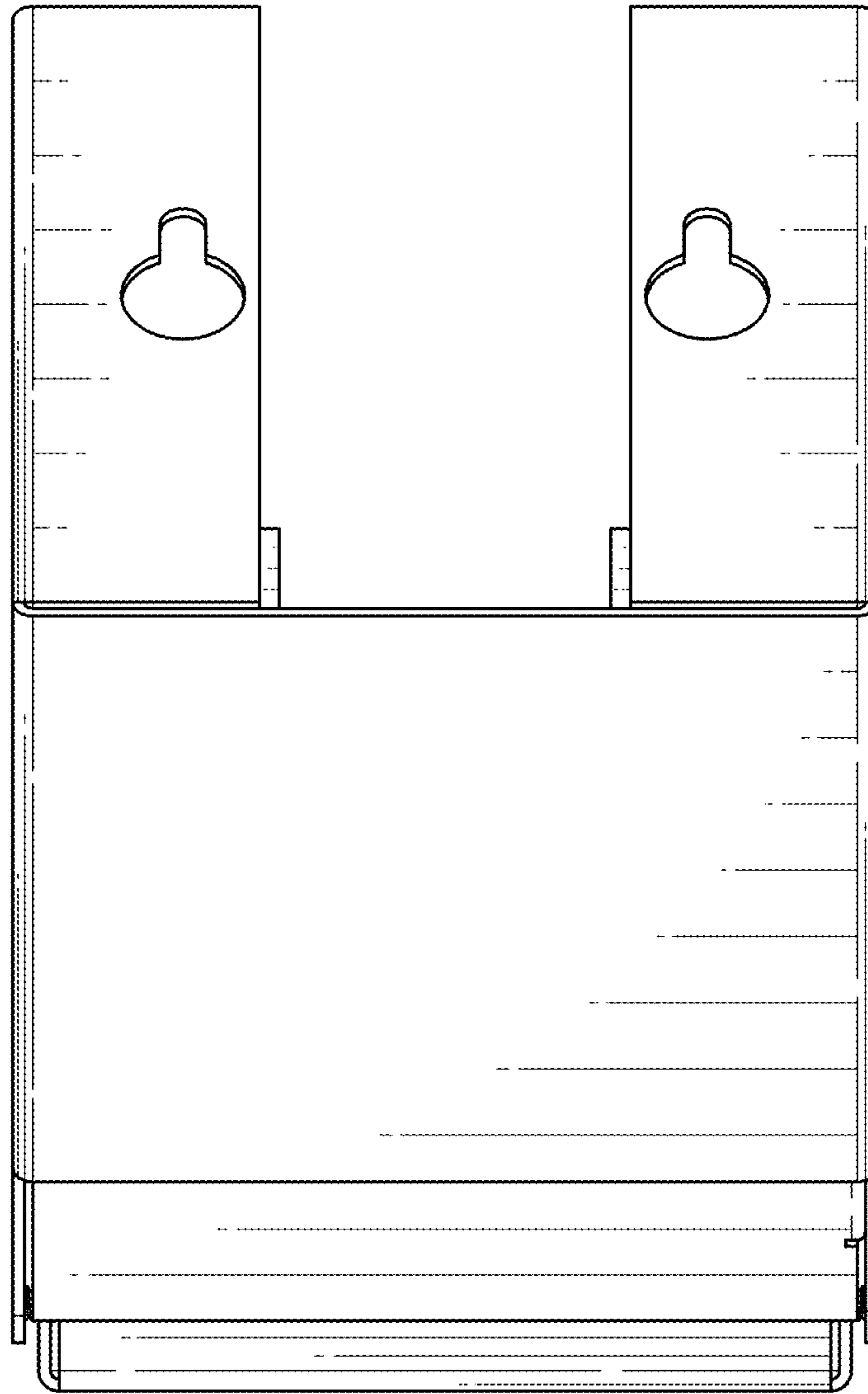

FIG. 7

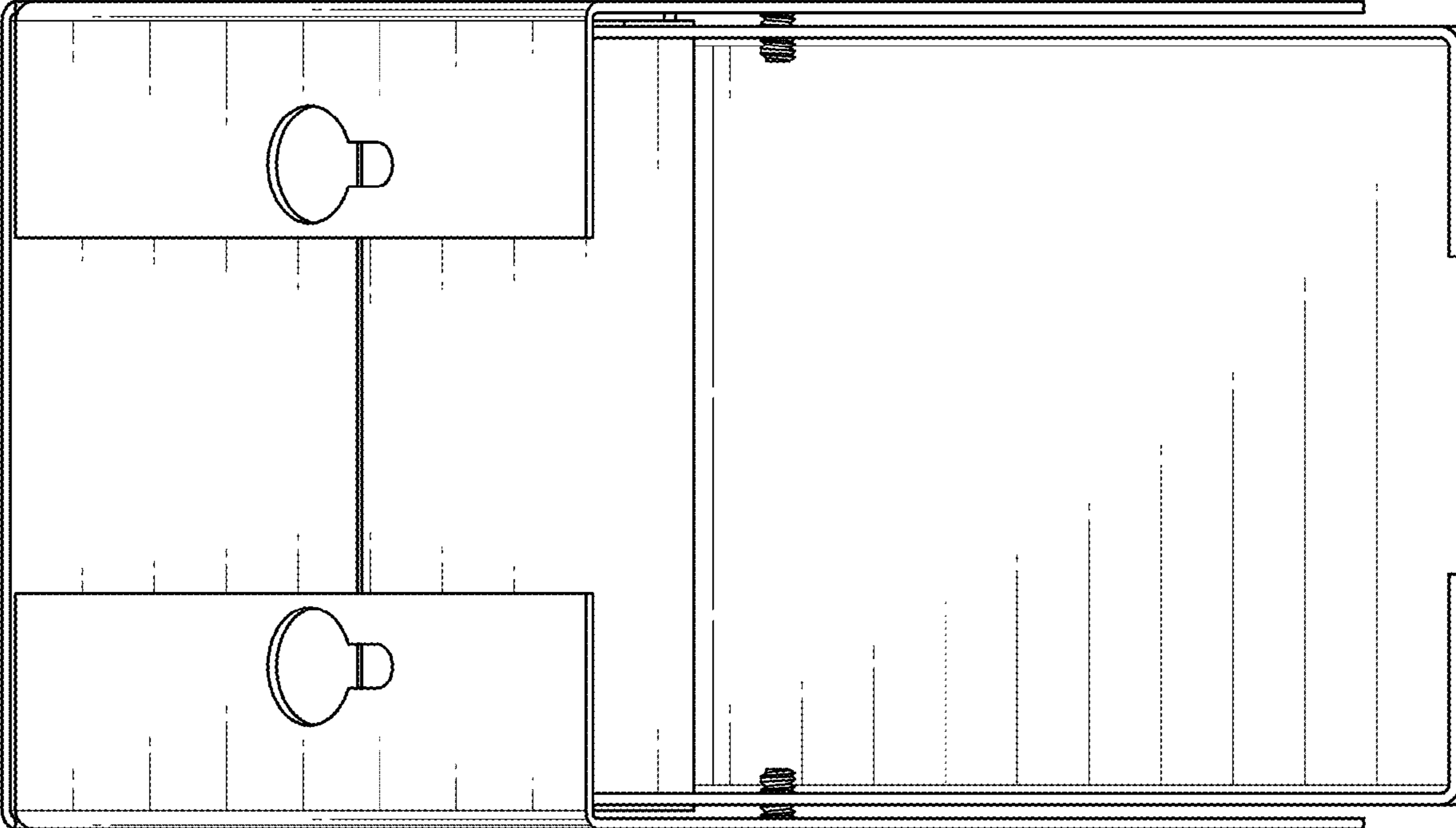

FIG. 8

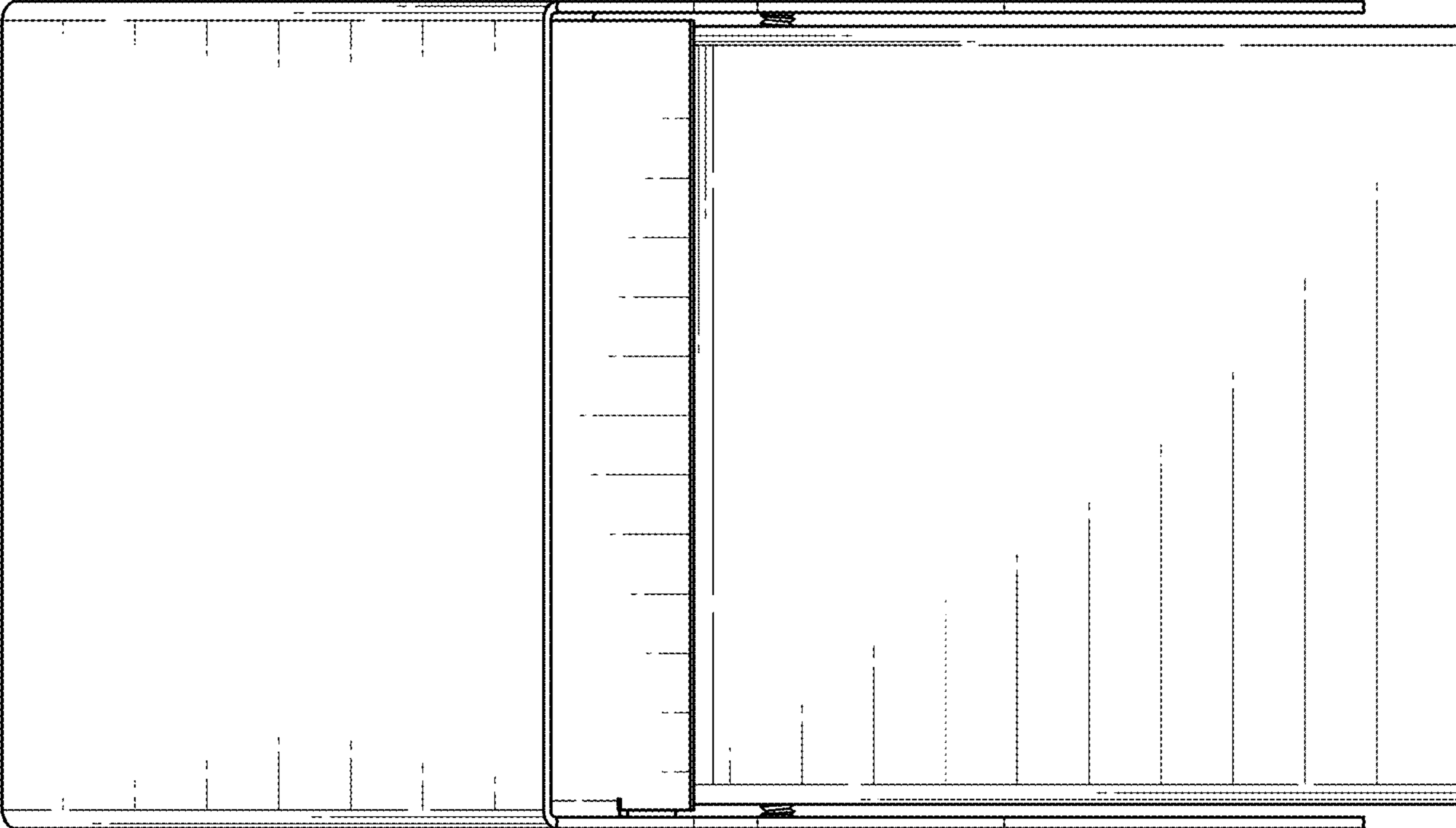

FIG. 9