



US00D919141S

(12) **United States Design Patent**
Wu

(10) **Patent No.:** **US D919,141 S**

(45) **Date of Patent:** **** May 11, 2021**

(54) **VEHICLE LIGHT**

(71) Applicant: **COPLUS INC.**, Tainan (TW)

(72) Inventor: **Po-Hua Wu**, Tainan (TW)

(73) Assignee: **Coplus Inc.**, Tainan (TW)

(**) Term: **15 Years**

(21) Appl. No.: **29/725,721**

(22) Filed: **Feb. 26, 2020**

(30) **Foreign Application Priority Data**

Jan. 14, 2020 (TW) 109300197D01

(51) **LOC (13) Cl.** **26-06**

(52) **U.S. Cl.**
USPC **D26/28**

(58) **Field of Classification Search**
USPC D26/28, 29, 30, 31, 32, 33, 34, 35, 36,
D26/44

CPC F21S 48/00; F21S 48/10; F21S 48/115;
F21S 48/225; F21S 48/1233; F21S
48/1266; F21S 48/1388; F21S 48/2268;
F21V 21/04; F21W 2103/35; F21W 3/40;
F21W 2102/17; F21W 2102/30; F21W
2103/00; F21W 2103/55; F21W 2104/00;
F21W 2107/17; F21W 2107/13

See application file for complete search history.

(56) **References Cited**

U.S. PATENT DOCUMENTS

D863,622 S * 10/2019 Wu D26/28
D869,022 S * 12/2019 Wu D26/28

D870,935 S * 12/2019 Wu D26/28
D874,696 S * 2/2020 He D26/28
D882,133 S * 4/2020 Wu D26/28
D888,298 S * 6/2020 Wu D26/28
D890,385 S * 7/2020 Yang D26/28
D890,388 S * 7/2020 Wu D26/28
D891,657 S * 7/2020 Wu D26/28
D905,301 S * 12/2020 Wu D26/28

* cited by examiner

Primary Examiner — Angela J Lee

(74) *Attorney, Agent, or Firm* — Lewis Roca Rothgerber
Christie LLP

(57) **CLAIM**

The ornamental design for a vehicle light, as shown and described.

DESCRIPTION

FIG. 1 is a perspective view of the vehicle light;
FIG. 2 is a front view thereof;
FIG. 3 is a left side view thereof;
FIG. 4 is a right side view thereof;
FIG. 5 is a top view thereof; and,
FIG. 6 is a bottom view thereof.

The broken lines in the drawings illustrate portions of the article that form no part of the claimed design. The rear view of the article is omitted and does not form any part of the claimed design.

1 Claim, 6 Drawing Sheets

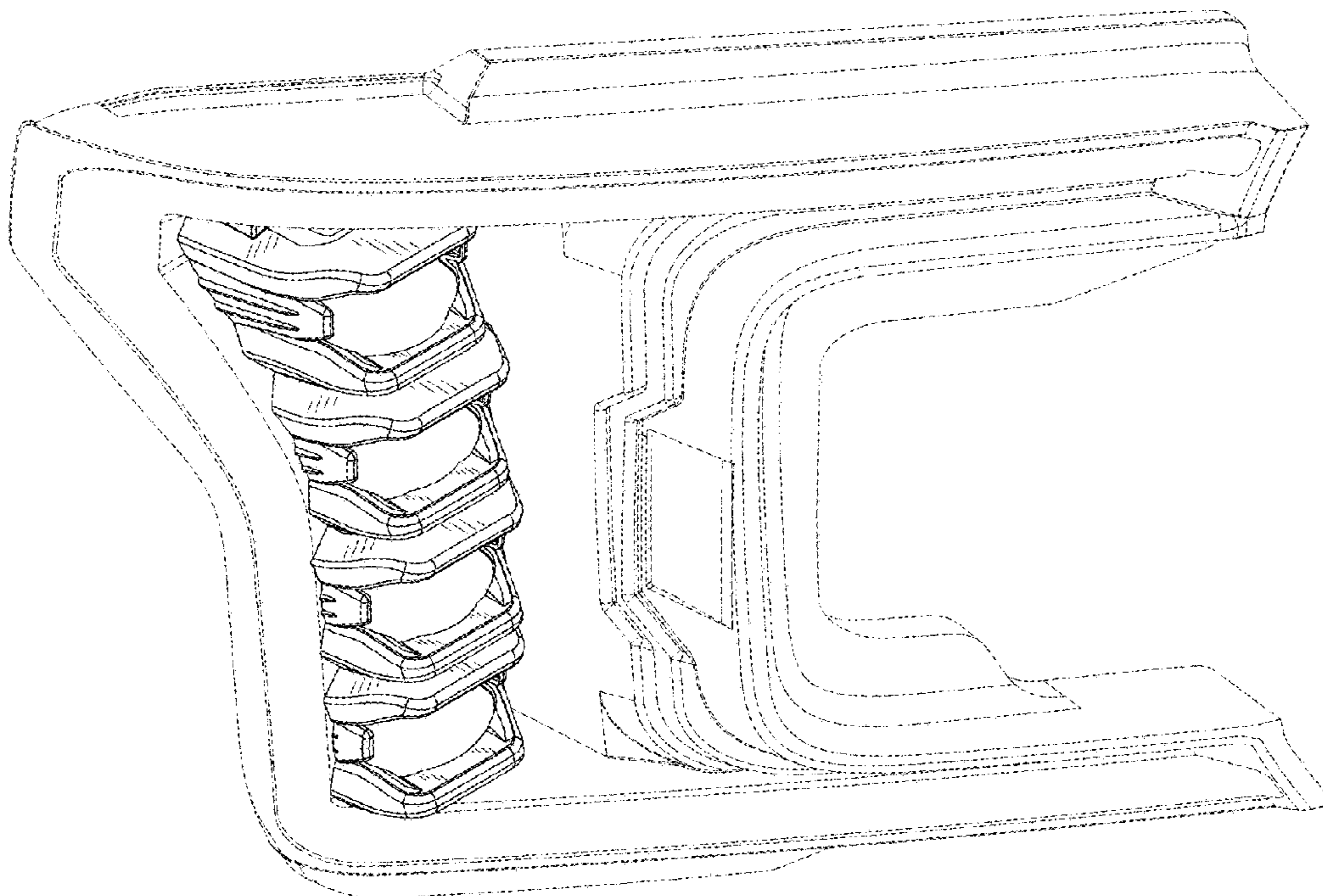

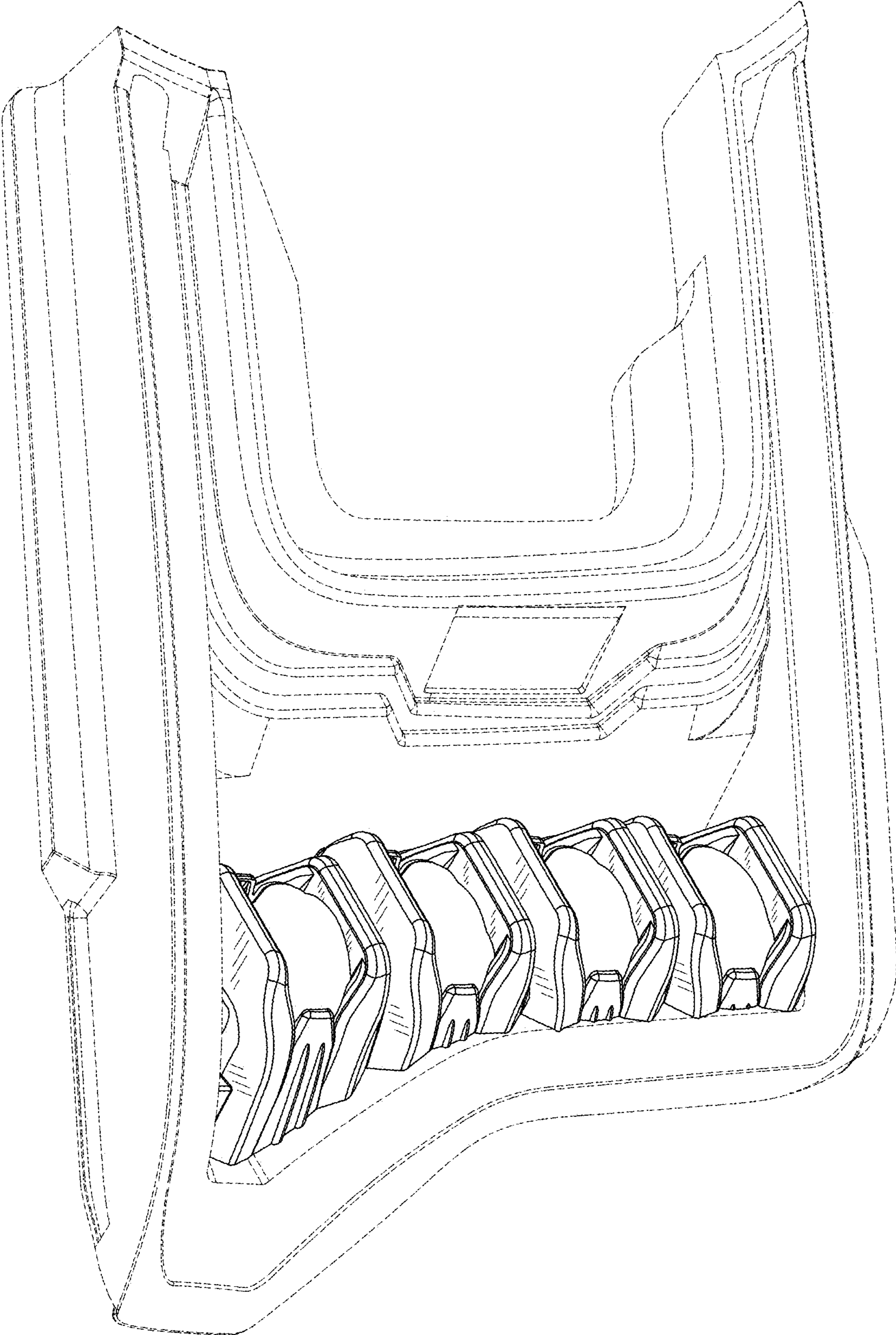

FIG. 1

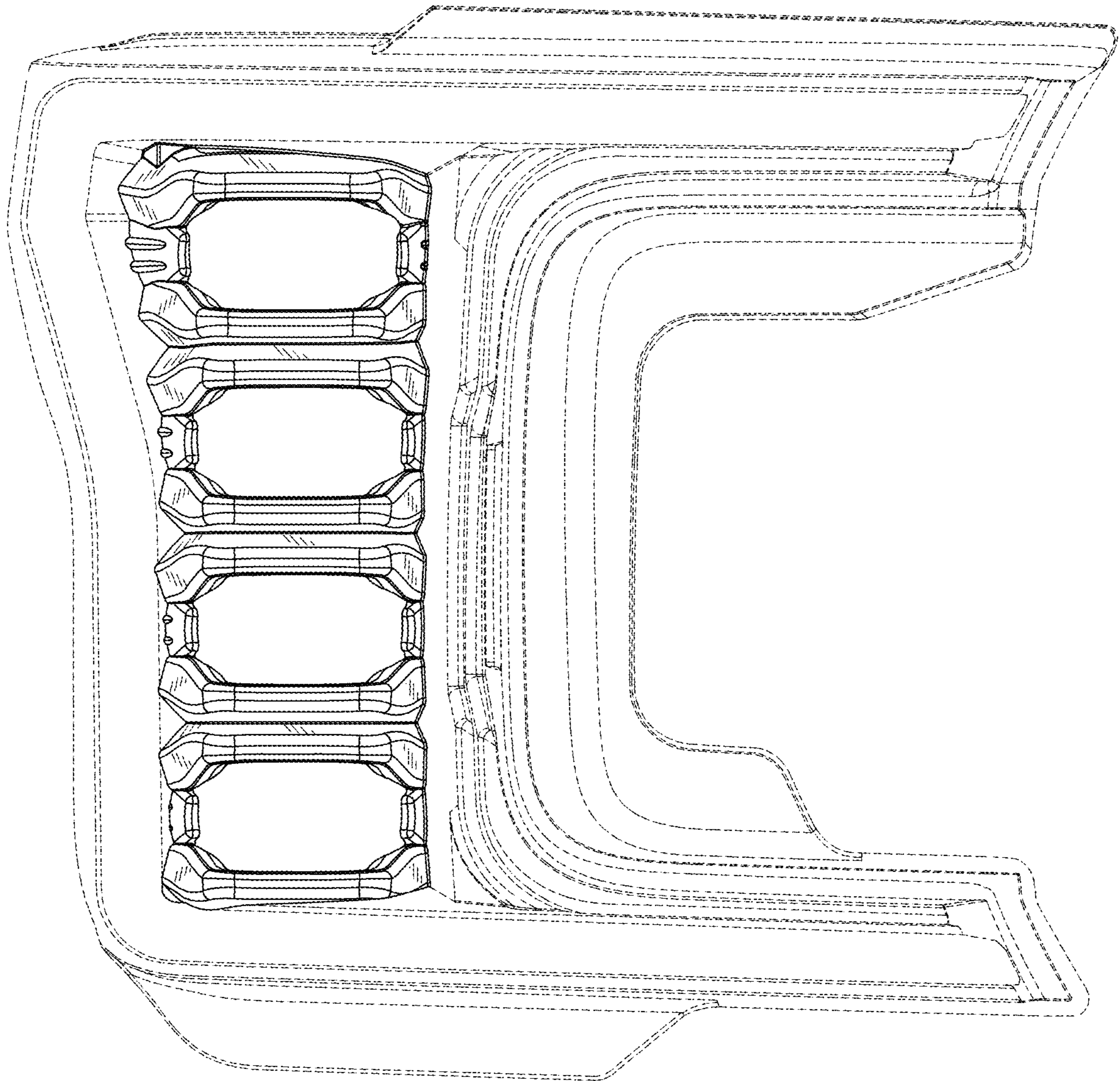

FIG. 2

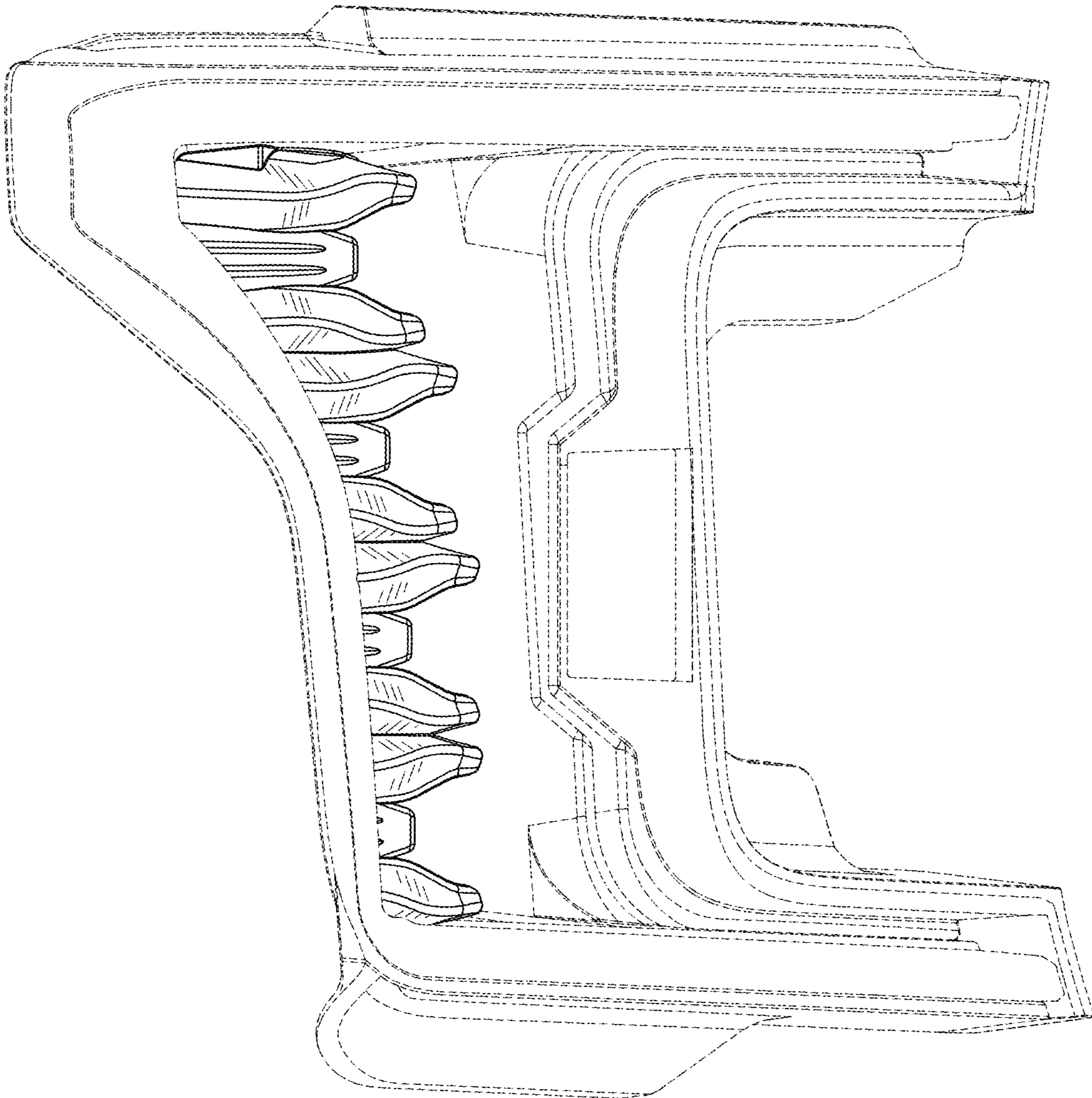

FIG. 3

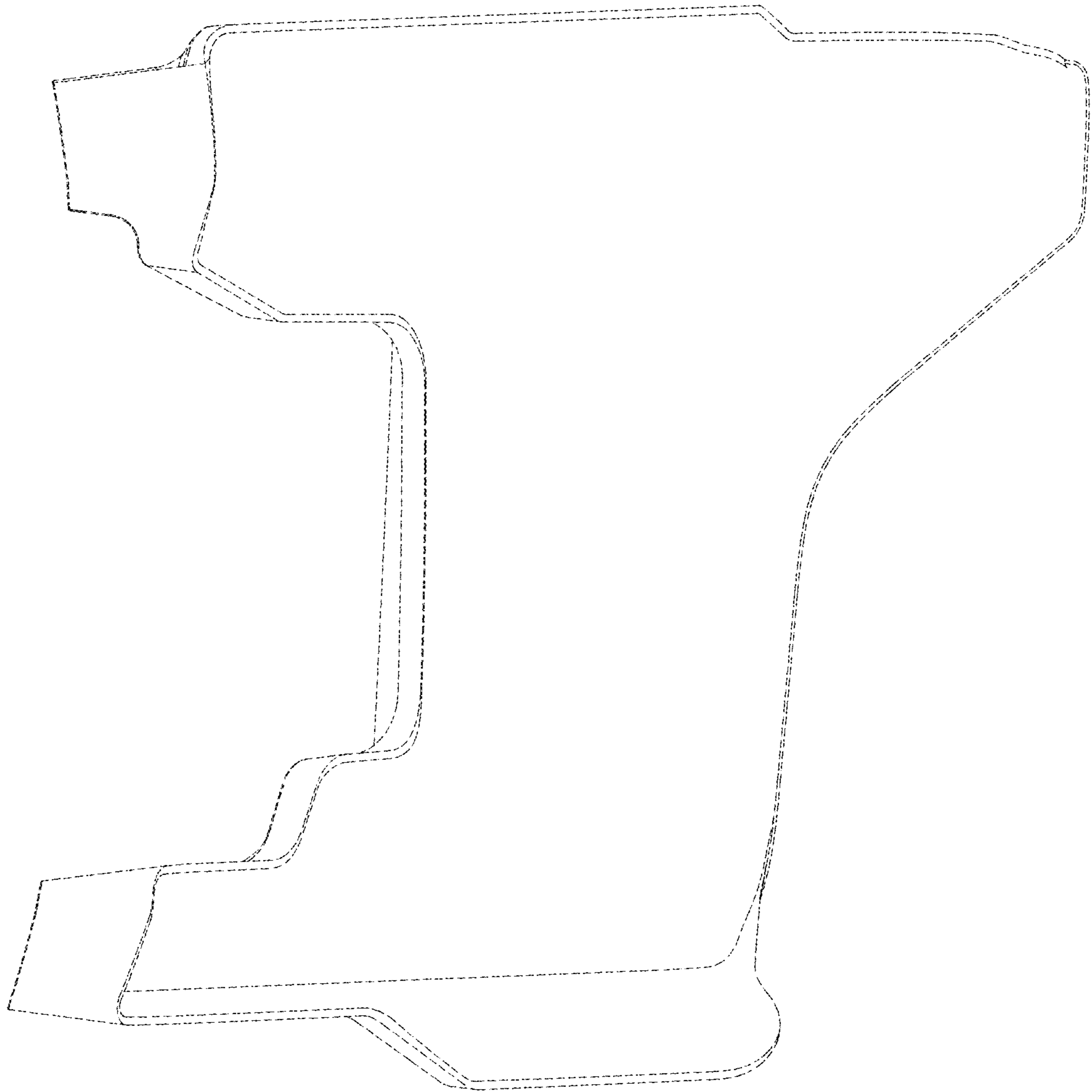

FIG. 4

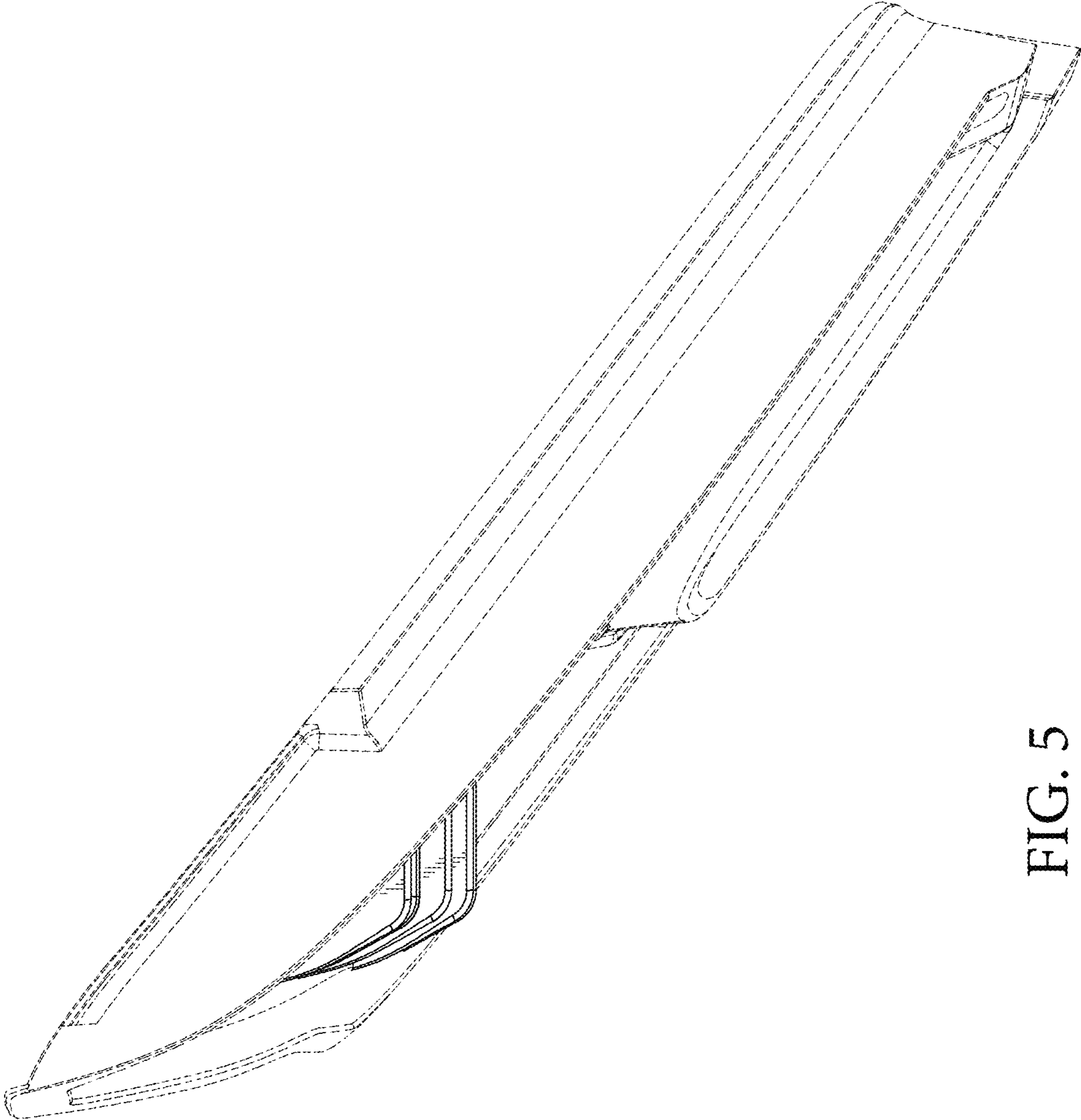

FIG. 5

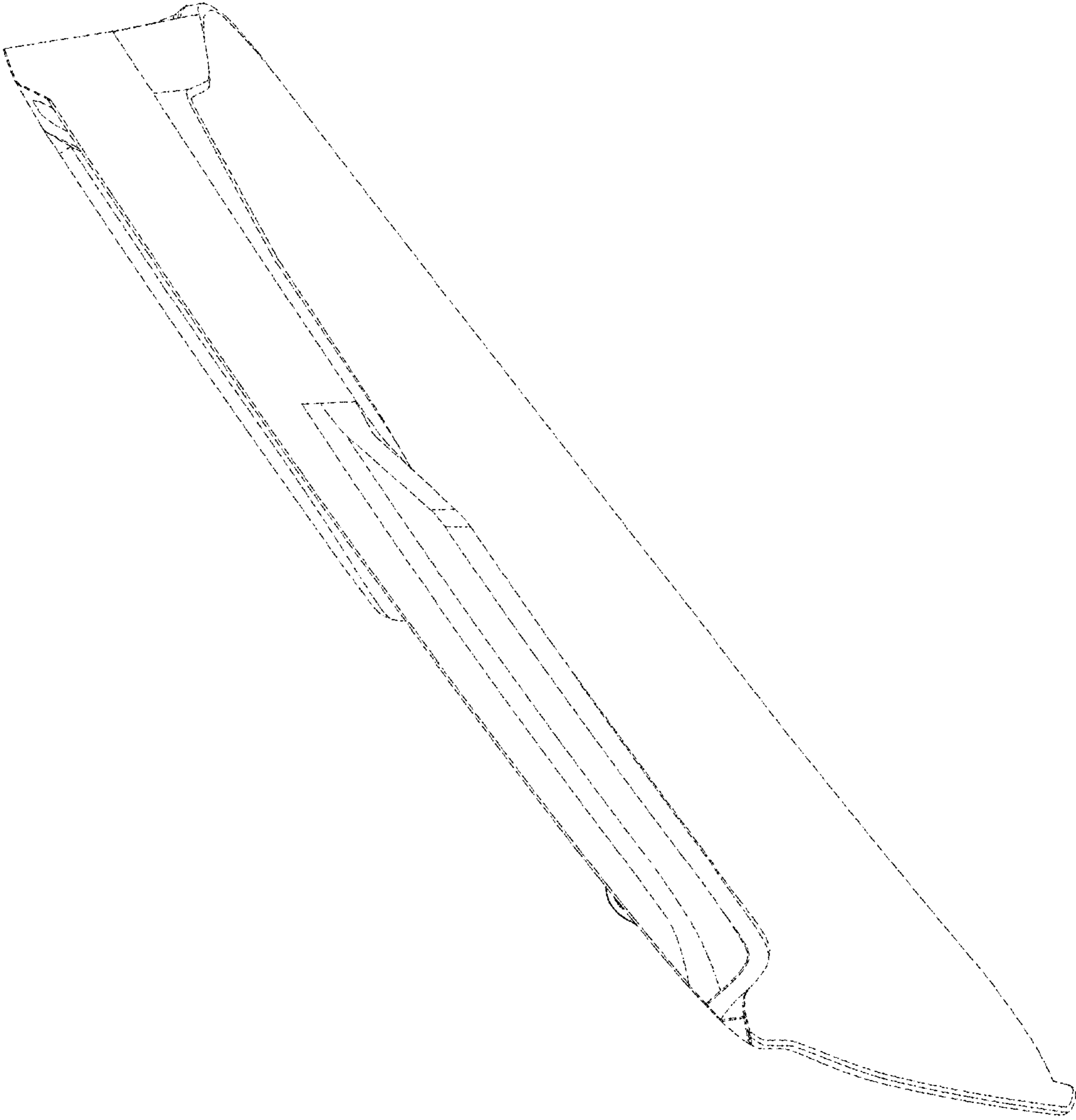

FIG. 6