



US00D919118S

(12) **United States Design Patent** (10) **Patent No.:** **US D919,118 S**  
**Music et al.** (45) **Date of Patent:** **\*\* May 11, 2021**

(54) **RETAIL FIXTURE**

(74) *Attorney, Agent, or Firm* — KPPB LLP

(71) Applicant: **Sonos, Inc.**, Santa Barbara, CA (US)

(57) **CLAIM**

(72) Inventors: **Fernando Music**, Santa Barbara, CA (US); **Anthony Sperduti**, Santa Barbara, CA (US)

The ornamental design for a retail fixture, as shown and described.

(73) Assignee: **Sonos, Inc.**, Santa Barbara, CA (US)

**DESCRIPTION**

(\*\*) Term: **15 Years**

(21) Appl. No.: **29/724,476**

(22) Filed: **Feb. 14, 2020**

**Related U.S. Application Data**

(63) Continuation of application No. 29/625,836, filed on Nov. 13, 2017, now Pat. No. Des. 880,001, which is (Continued)

(51) **LOC (13) Cl.** ..... **25-03**

(52) **U.S. Cl.**  
USPC ..... **D25/18; D25/16**

(58) **Field of Classification Search**  
USPC ..... D21/494, 500, 501, 502, 506, 507, 508, D21/511, 836, 838; D25/1, 3, 4, 12, 15, (Continued)

(56) **References Cited**

**U.S. PATENT DOCUMENTS**

D262,098 S \* 12/1981 Odle ..... D11/133  
D432,593 S \* 10/2000 Naughton ..... D21/511  
(Continued)

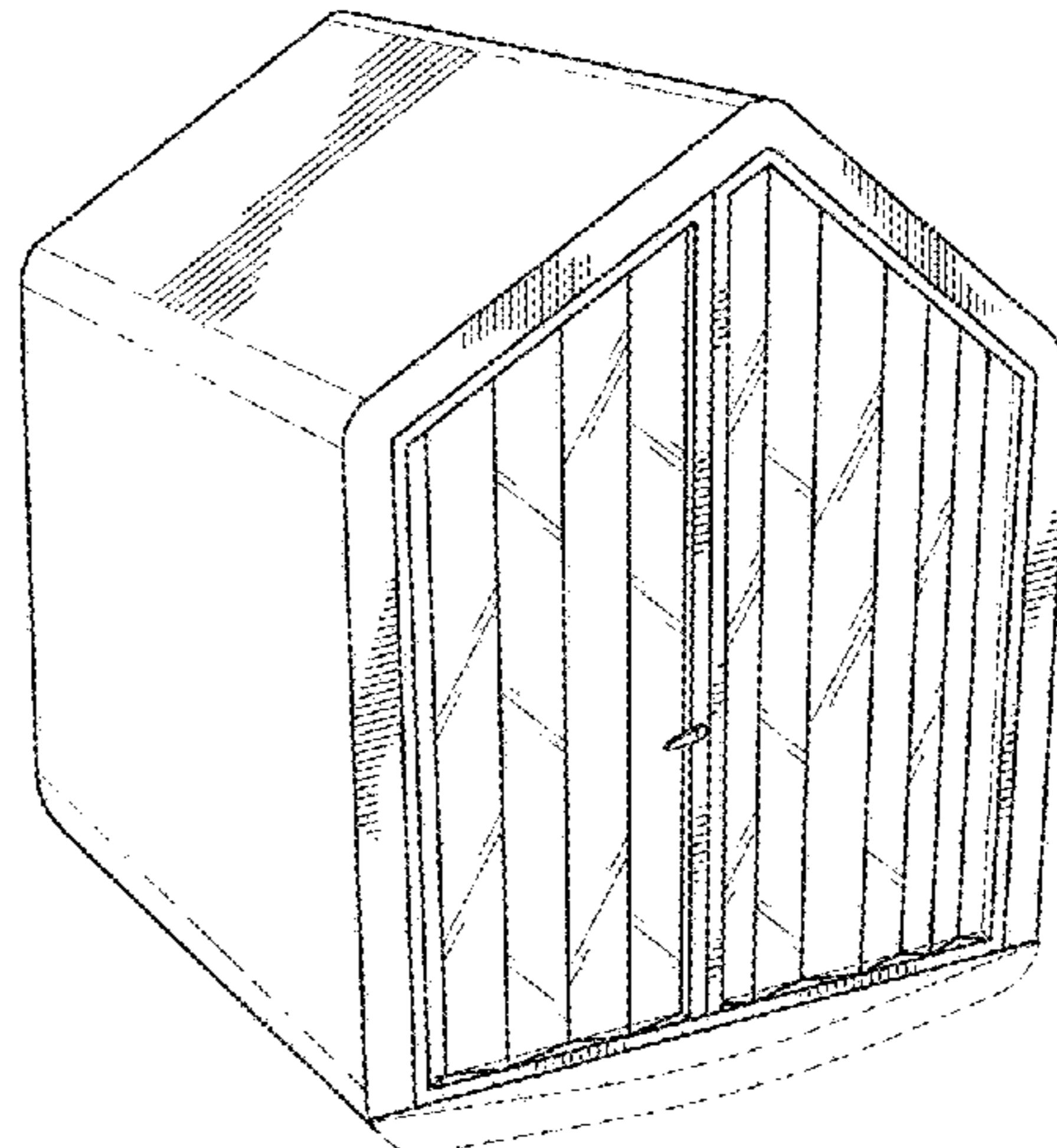
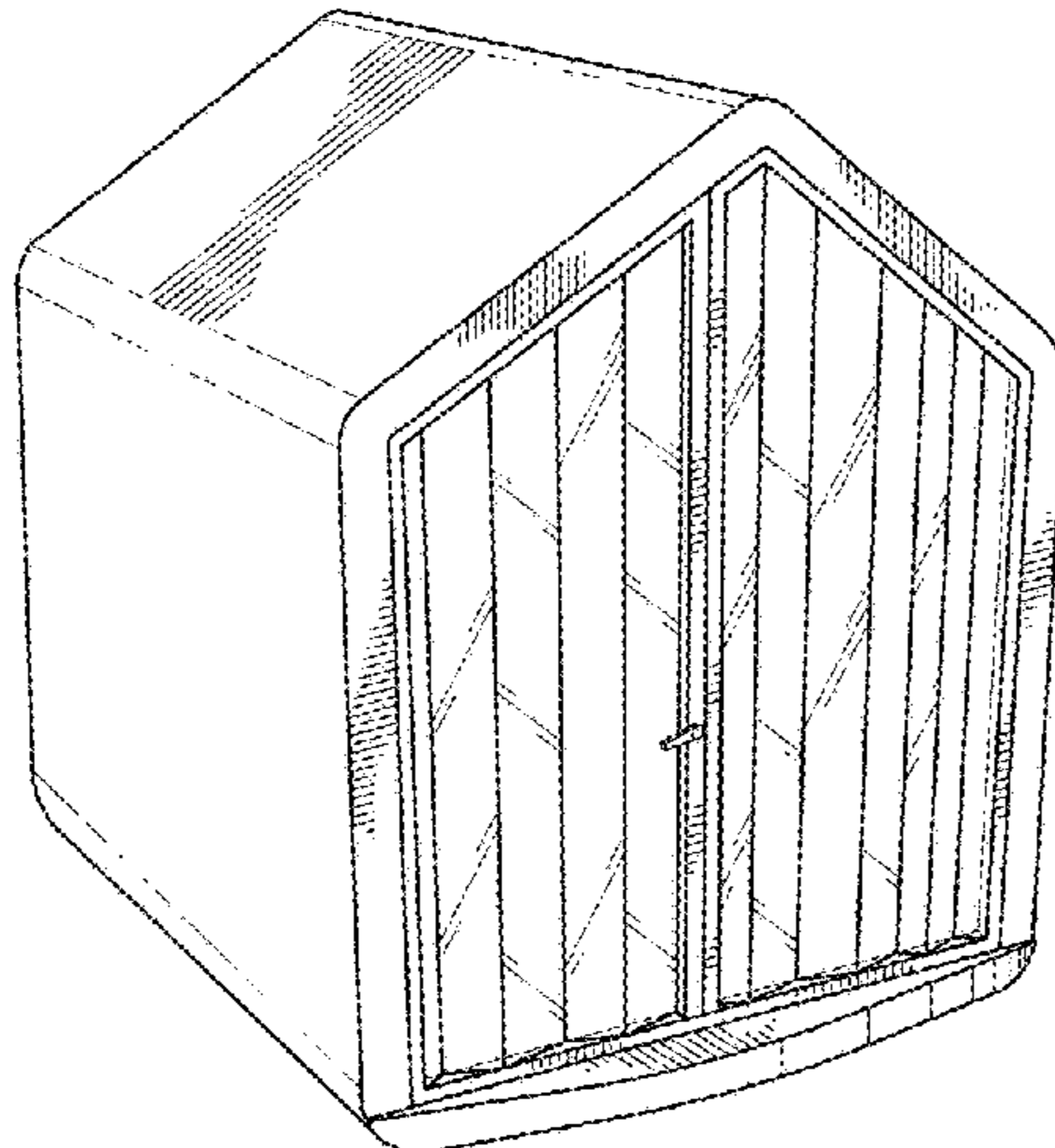
**FOREIGN PATENT DOCUMENTS**

CN 304007655 S 1/2017  
CN 304184958 S 6/2017  
(Continued)

*Primary Examiner* — Brett Miller  
*Assistant Examiner* — Suzanne E Tisdell

FIG. 1 is a first perspective view of a retail fixture in accordance with a first embodiment;  
FIG. 2 is a second perspective view thereof;  
FIG. 3 is a front elevational view thereof;  
FIG. 4 is a rear elevational view thereof;  
FIG. 5 is a first side elevational view thereof;  
FIG. 6 is a second side elevational view thereof;  
FIG. 7 is a top elevational view thereof;  
FIG. 8 is a bottom elevational view thereof;  
FIG. 9 is a first perspective view of a retail fixture in accordance with a second embodiment;  
FIG. 10 is a second perspective view thereof;  
FIG. 11 is a front elevational view thereof;  
FIG. 12 is a rear elevational view thereof;  
FIG. 13 is a first side elevational view thereof;  
FIG. 14 is a second side elevational view thereof;  
FIG. 15 is a top elevational view thereof;  
FIG. 16 is a bottom elevational view thereof;  
FIG. 17 is a first perspective view of the retail fixture of FIG. 1 shown in a first environment of use;  
FIG. 18 is a rear perspective view thereof;  
FIG. 19 is a first side perspective view thereof;  
FIG. 20 is a second side perspective view thereof;  
FIG. 21 is a top elevational view thereof;  
FIG. 22 is a bottom elevational view thereof;  
FIG. 23 is a front elevational view of the retail fixture shown in a second environment of use;  
FIG. 24 is a rear elevational view thereof;  
FIG. 25 is a first side elevational view thereof;  
FIG. 26 is a second side elevational view thereof;  
FIG. 27 is a top elevational view thereof; and,  
FIG. 28 is a bottom elevational view thereof.  
The broken lines in FIGS. 9-16 illustrate portions of the retail fixture that form no part of the claimed design. The

(Continued)



broken lines in FIGS. 17-28 illustrate environmental subject matter and form no part of the claimed design.

**1 Claim, 18 Drawing Sheets**

**Related U.S. Application Data**

a continuation of application No. 29/551,801, filed on Jan. 15, 2016, now Pat. No. Des. 806,264.

**(58) Field of Classification Search**

USPC ..... D25/16, 17, 21, 22, 23, 24, 25, 26, 29, D25/30, 34, 56, 57, 58, 59, 61, 138, 139, D25/199

CPC ..... E04B 1/99; E04B 2/30; E04F 8/02; G06F 3/048; G06F 3/16; G06F 17/10; G06F 17/50; G06N 5/02; H03G 3/00

See application file for complete search history.

**(56) References Cited**

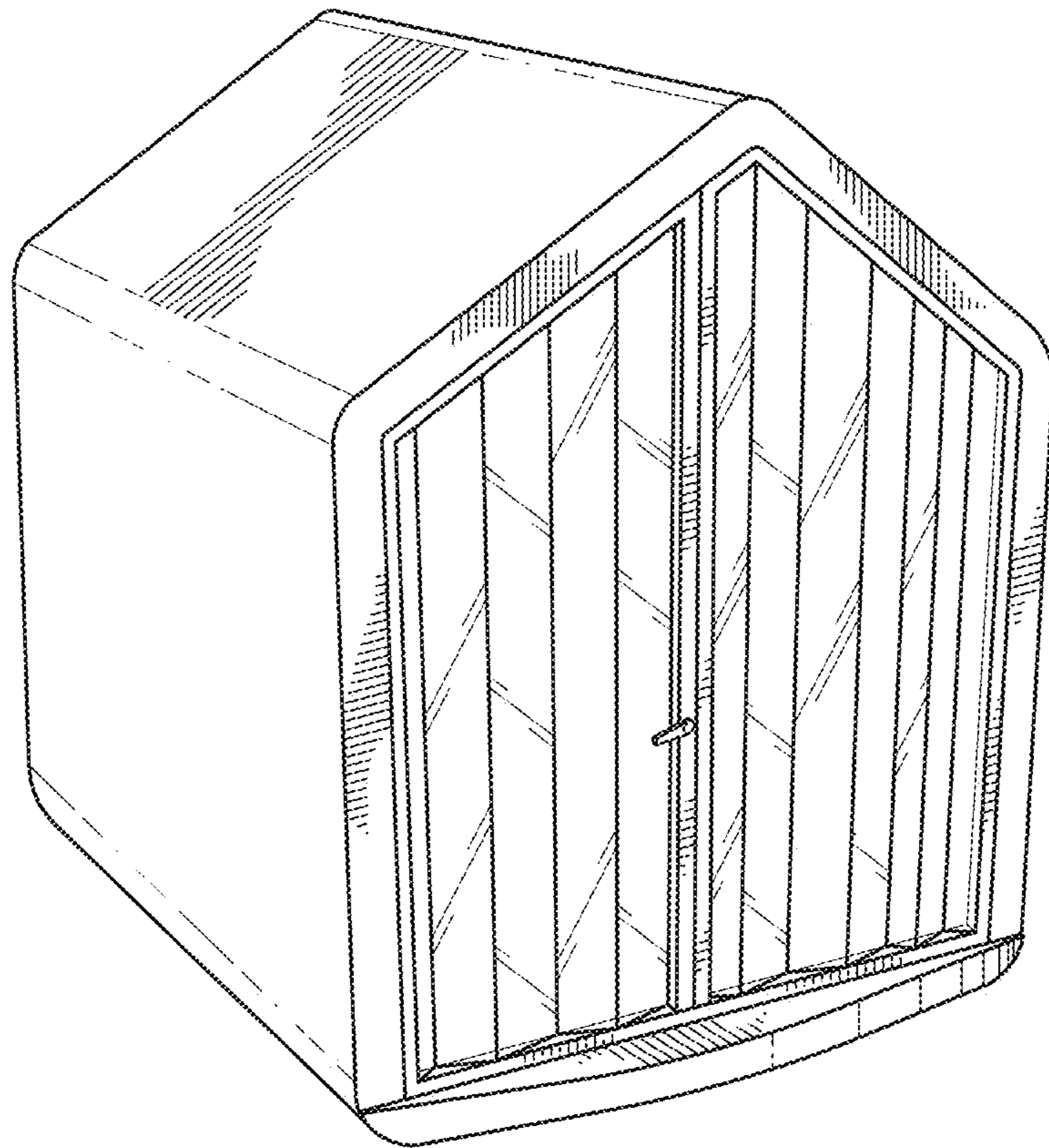
U.S. PATENT DOCUMENTS

D505,176 S *	5/2005	Wehner .....	D21/834
D569,450 S *	5/2008	Halliday .....	D21/511
D569,451 S *	5/2008	Halliday .....	D21/511
D623,242 S *	9/2010	Greer .....	D21/511
D634,445 S *	3/2011	Mason .....	D25/56
D635,279 S *	3/2011	Mathon .....	D25/138
D664,217 S *	7/2012	Jolly, III .....	D21/511
D682,951 S *	5/2013	Sandhei .....	D21/506
D699,793 S *	2/2014	Gomez .....	D21/511
D735,276 S *	7/2015	Radu .....	D21/511
D806,264 S *	12/2017	Music .....	D25/17

FOREIGN PATENT DOCUMENTS

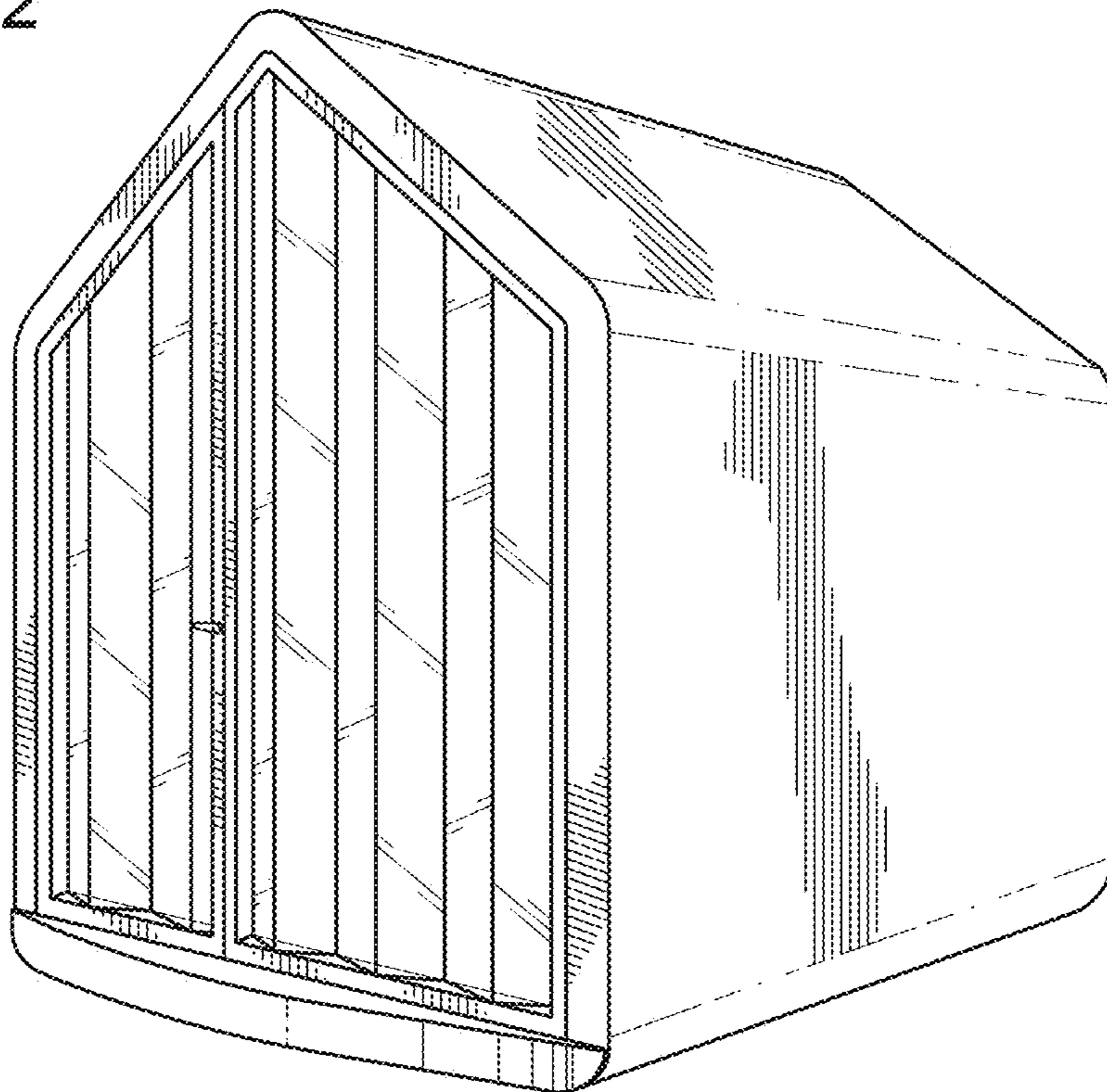
EM	003191436-0001	6/2016
EM	003191436-0002	6/2016
EM	003191436-0003	6/2016
EM	003191436-0004	6/2016
EM	003191436-0005	6/2016
EM	003191436-0006	6/2016
EM	003191436-0007	6/2016
EM	003191436-0008	6/2016
EM	003191436-0009	6/2016
EM	003191436-0010	6/2016
EM	003191436-0011	6/2016
EM	003191436-0012	6/2016
EM	003191436-0013	6/2016
EM	003191436-0014	6/2016
EM	003191436-0015	6/2016
EM	003191436-0016	6/2016
EM	003191436-0017	6/2016
EM	003191436-0018	6/2016
EM	003191436-0019	6/2016
EM	003191436-0020	6/2016
EM	003191436-0021	6/2016
EM	003191436-0022	6/2016
EM	003191436-0023	6/2016
EM	003191436-0024	6/2016
EM	003191436-0025	6/2016
EM	003191436-0026	6/2016
EM	003191436-0027	6/2016
EM	003191436-0028	6/2016
EM	003191436-0029	6/2016
EM	003191436-0030	6/2016
EM	003191436-0031	6/2016
JP	1567539 S	12/2016
JP	1567540 S	12/2016

\* cited by examiner

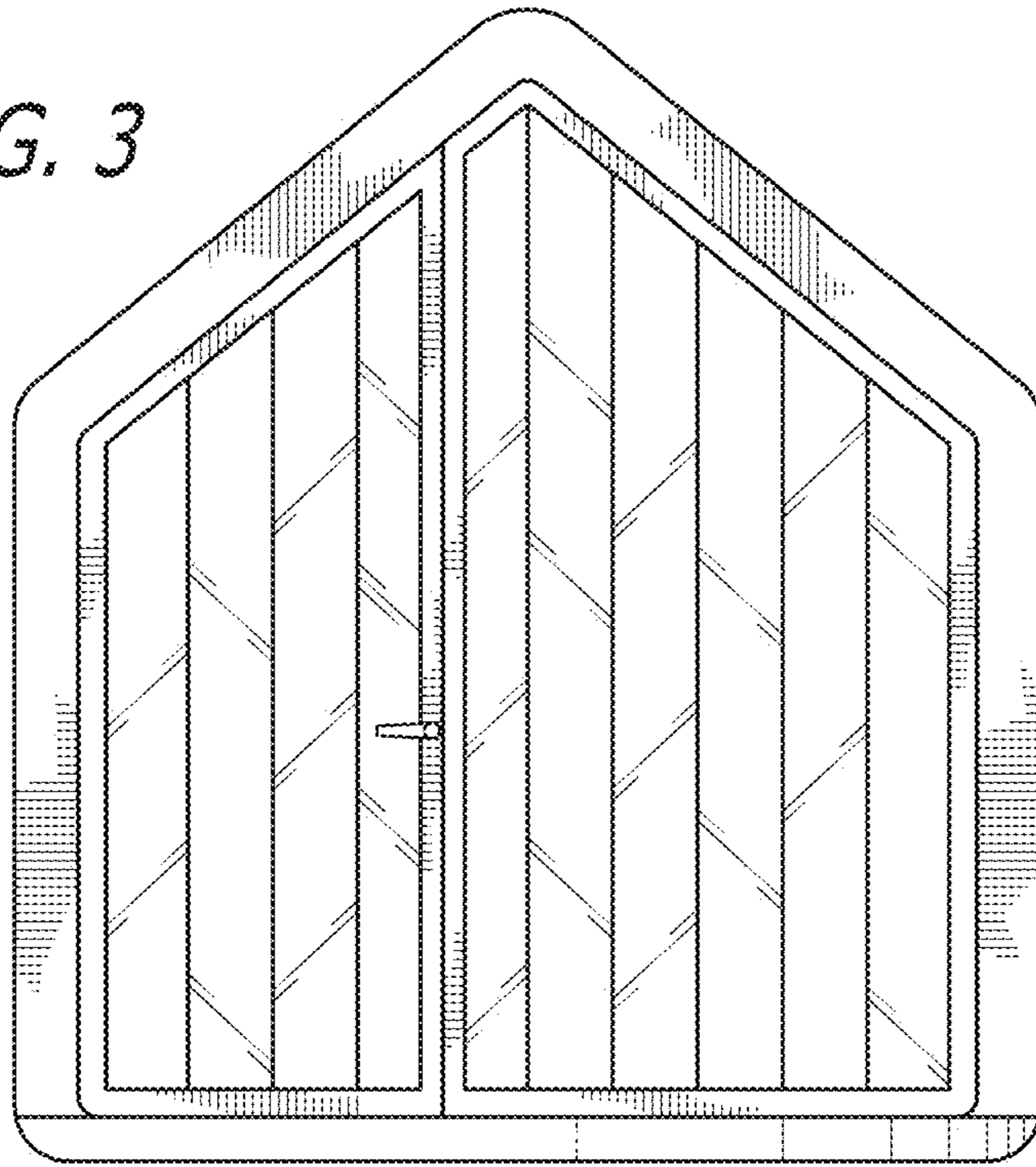


*FIG. 1*

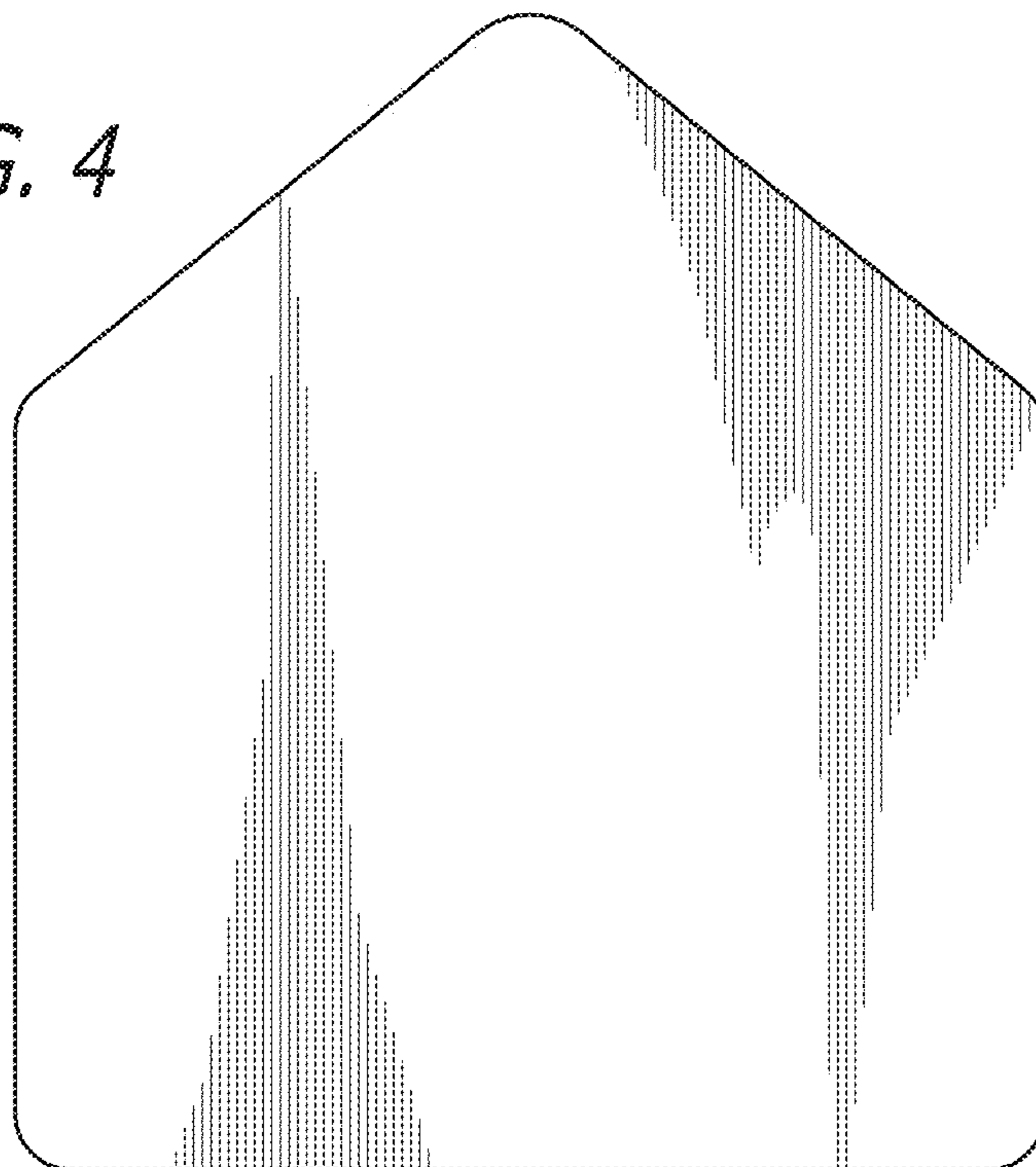
*FIG. 2*



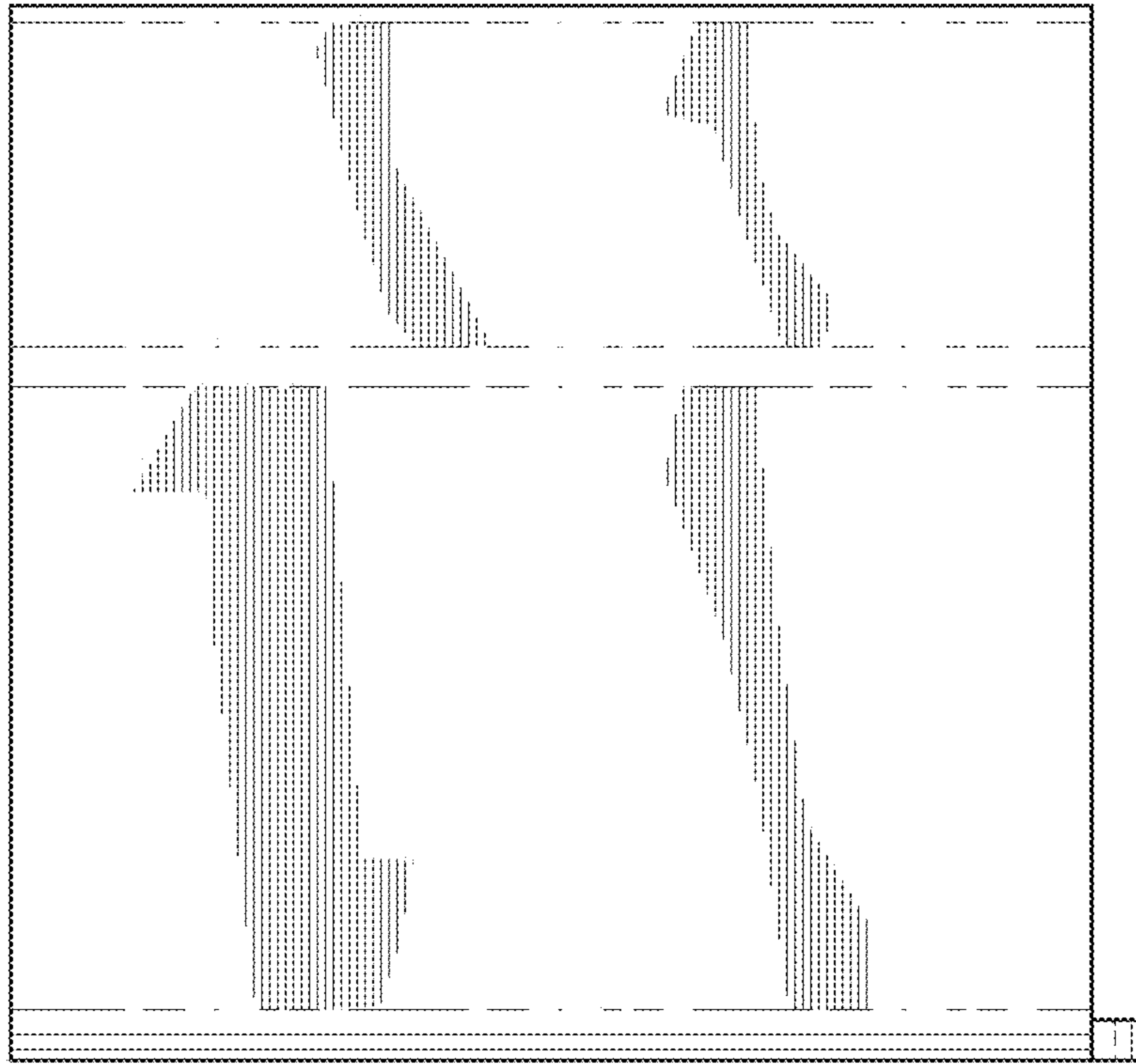
*FIG. 3*



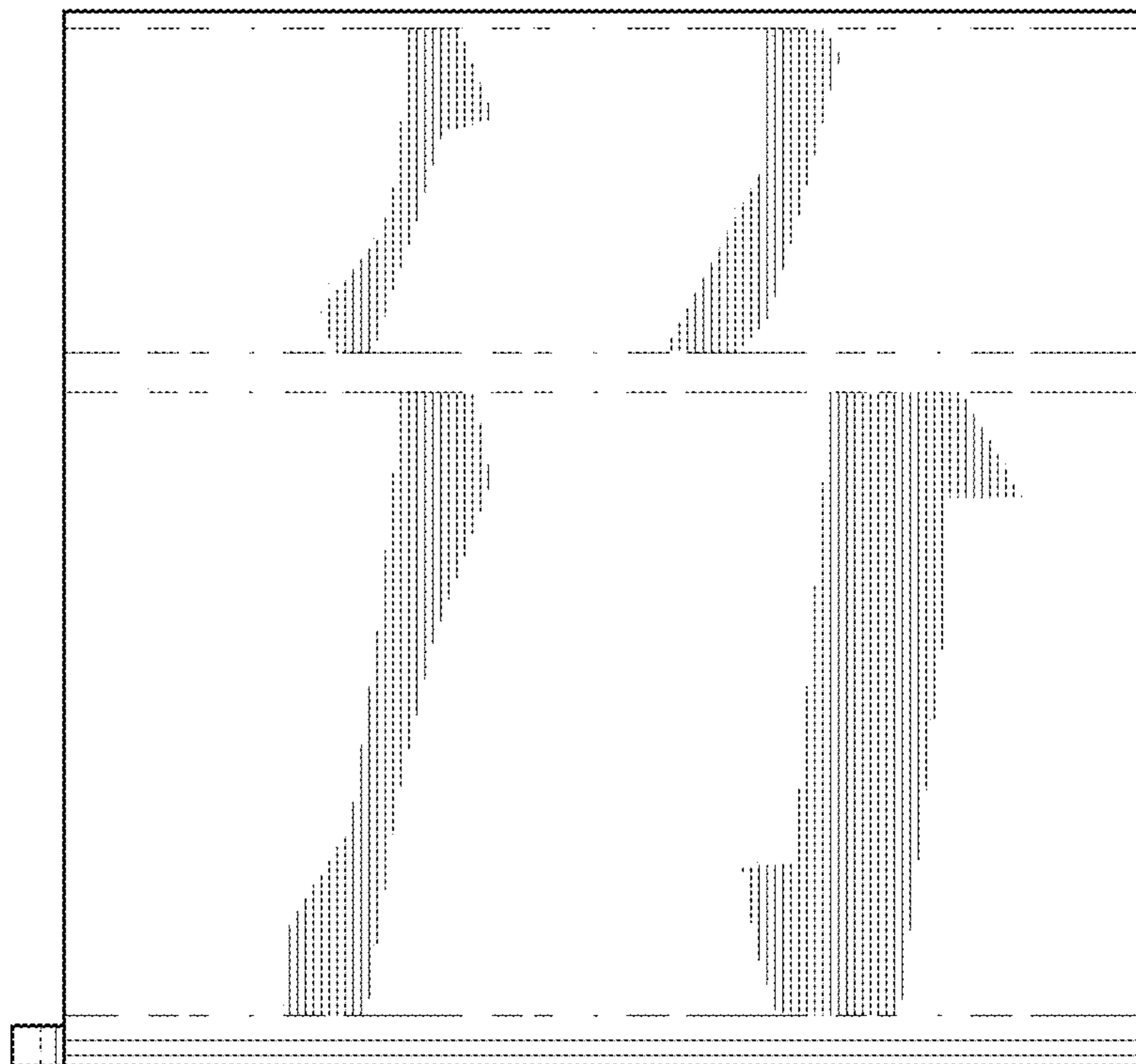
*FIG. 4*



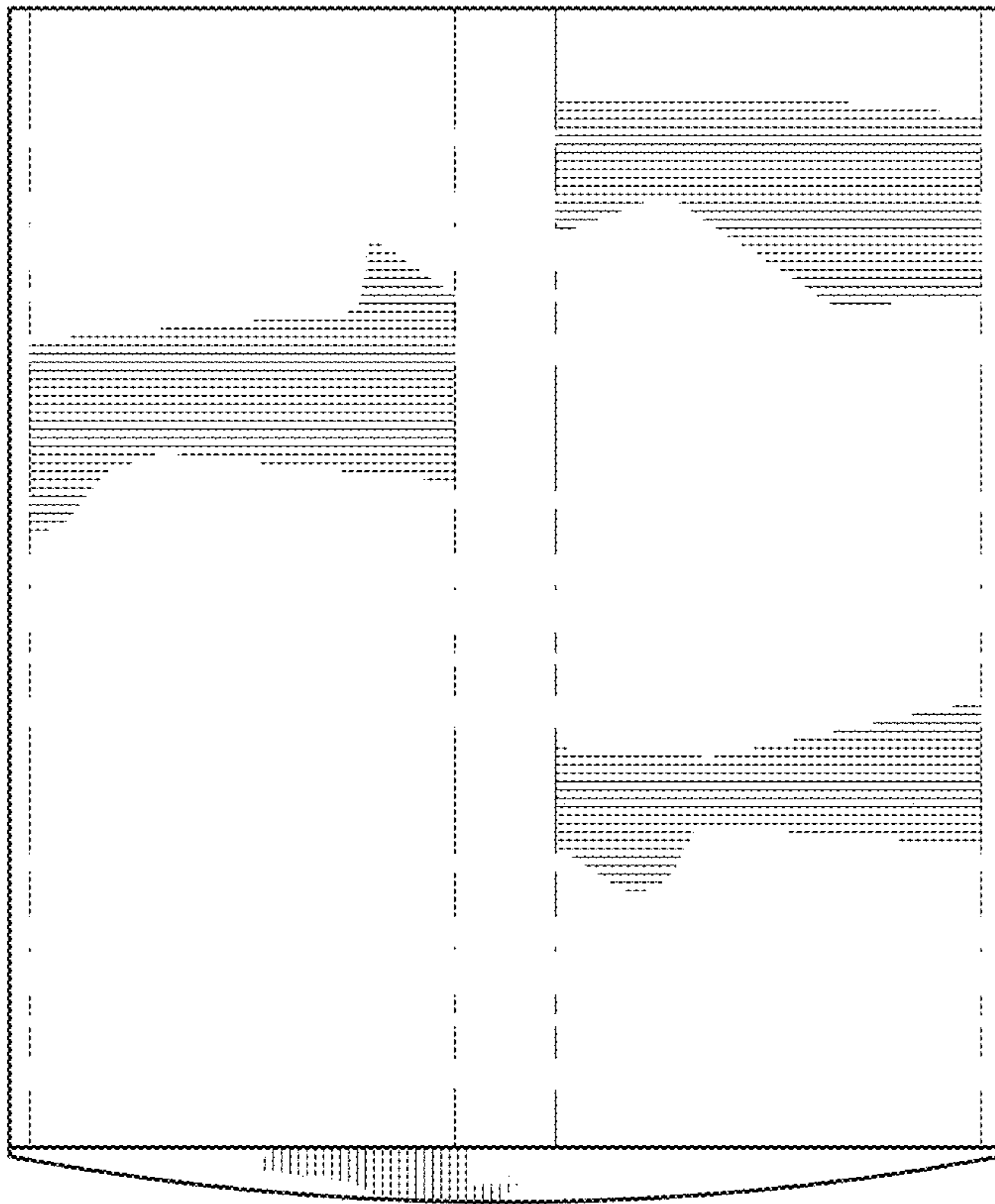
*FIG. 5*



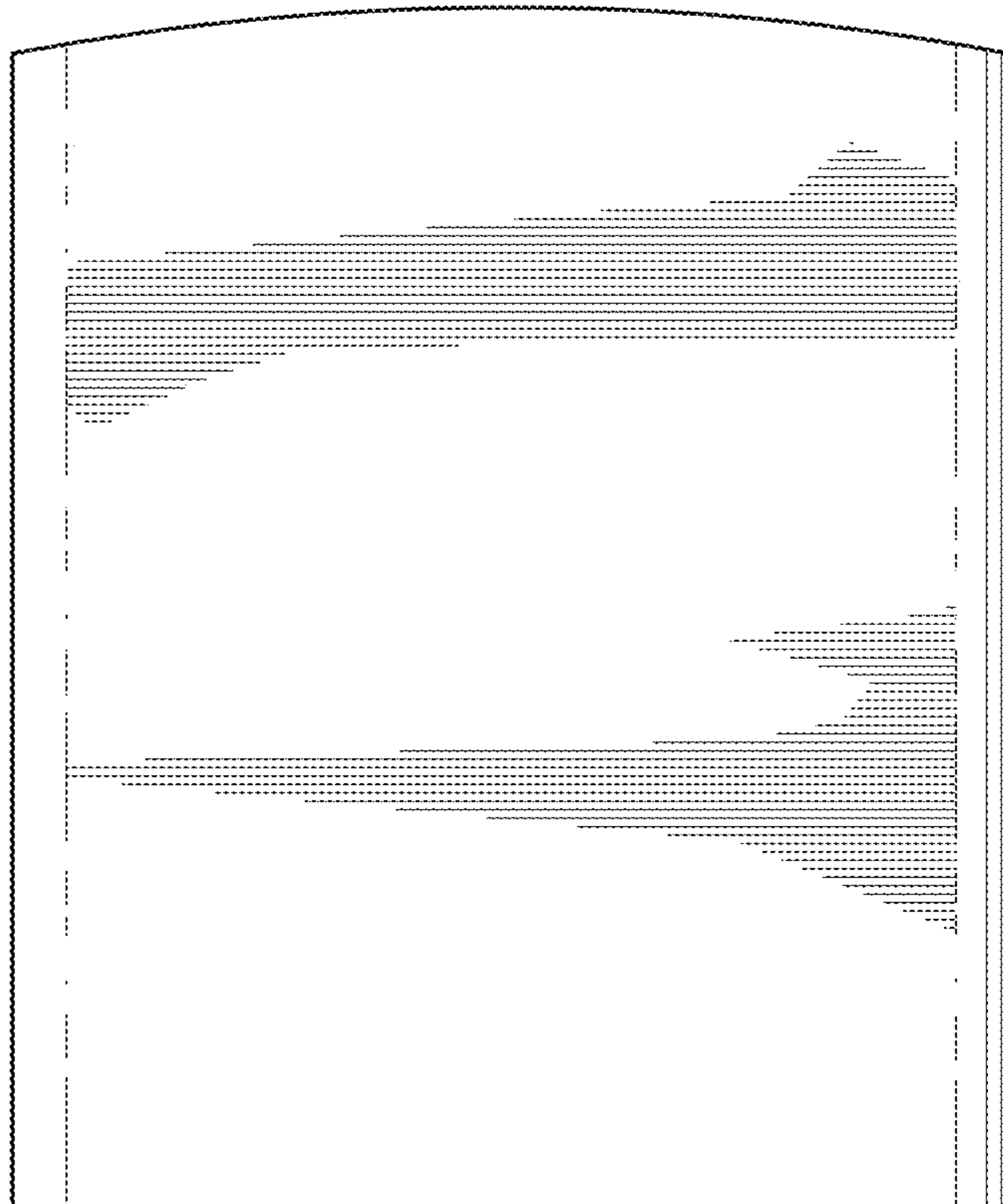
*FIG. 6*



*FIG. 7*



*FIG. 8*



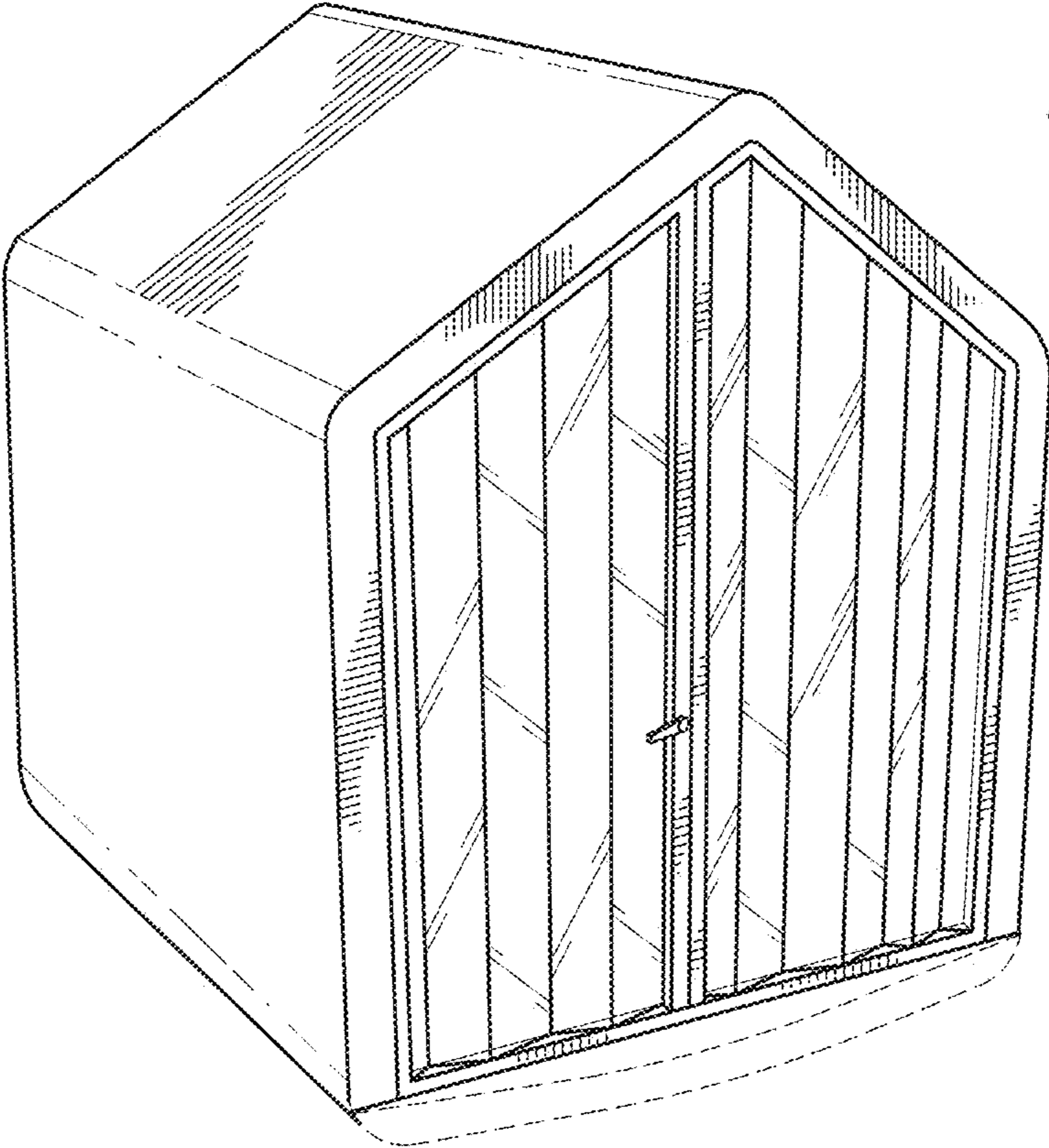


FIG. 9

FIG. 10

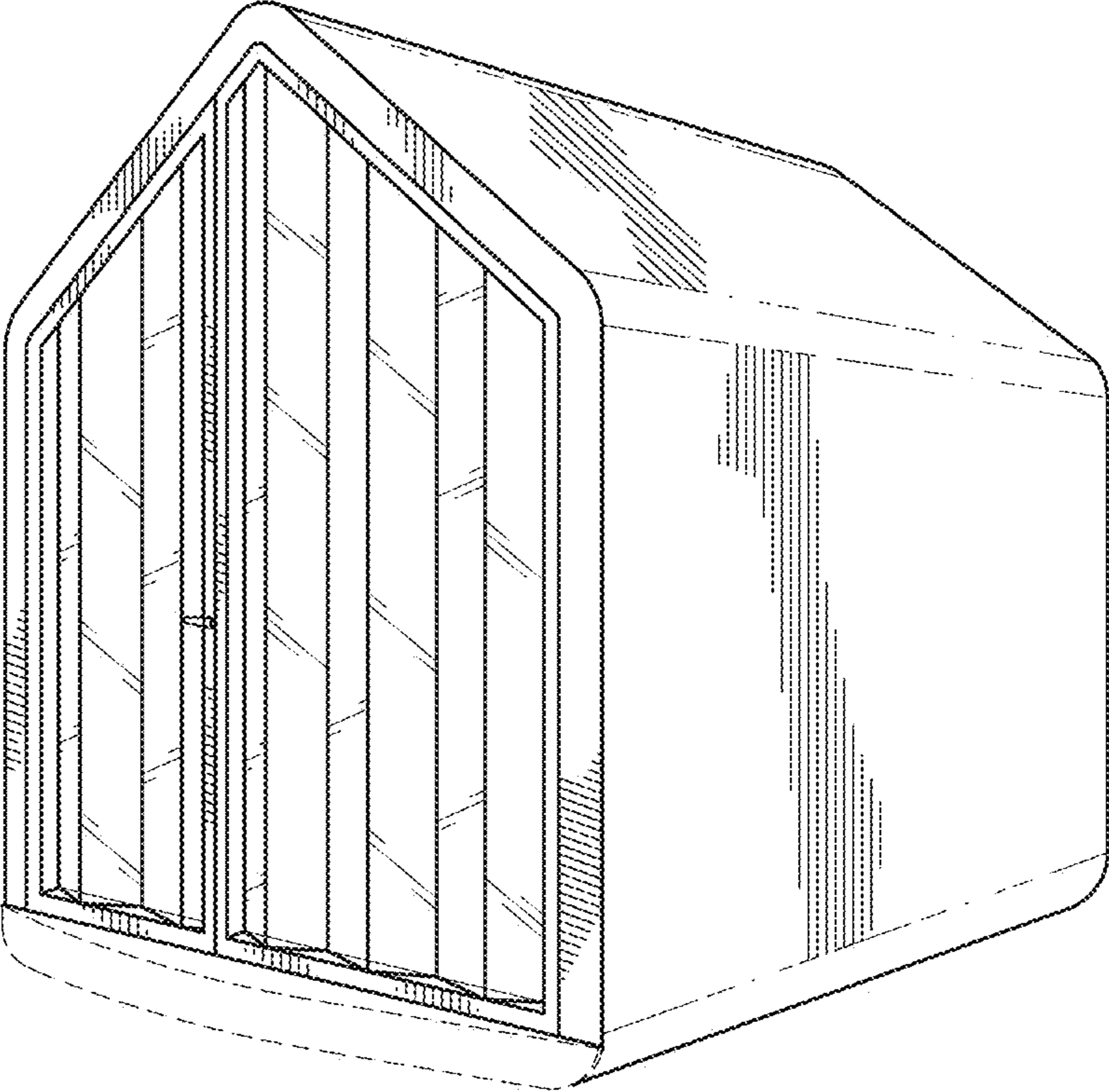


FIG. 11

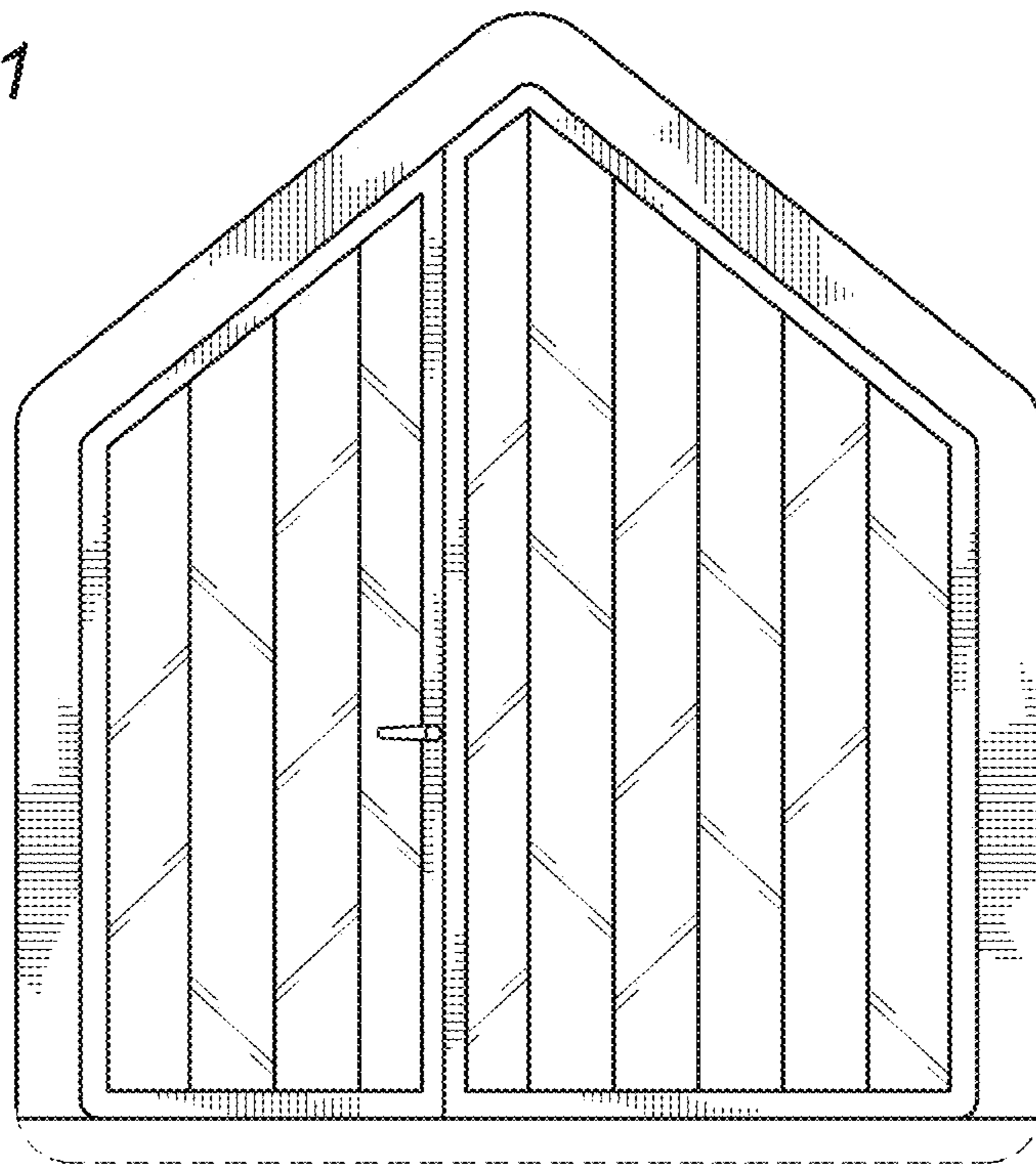


FIG. 12

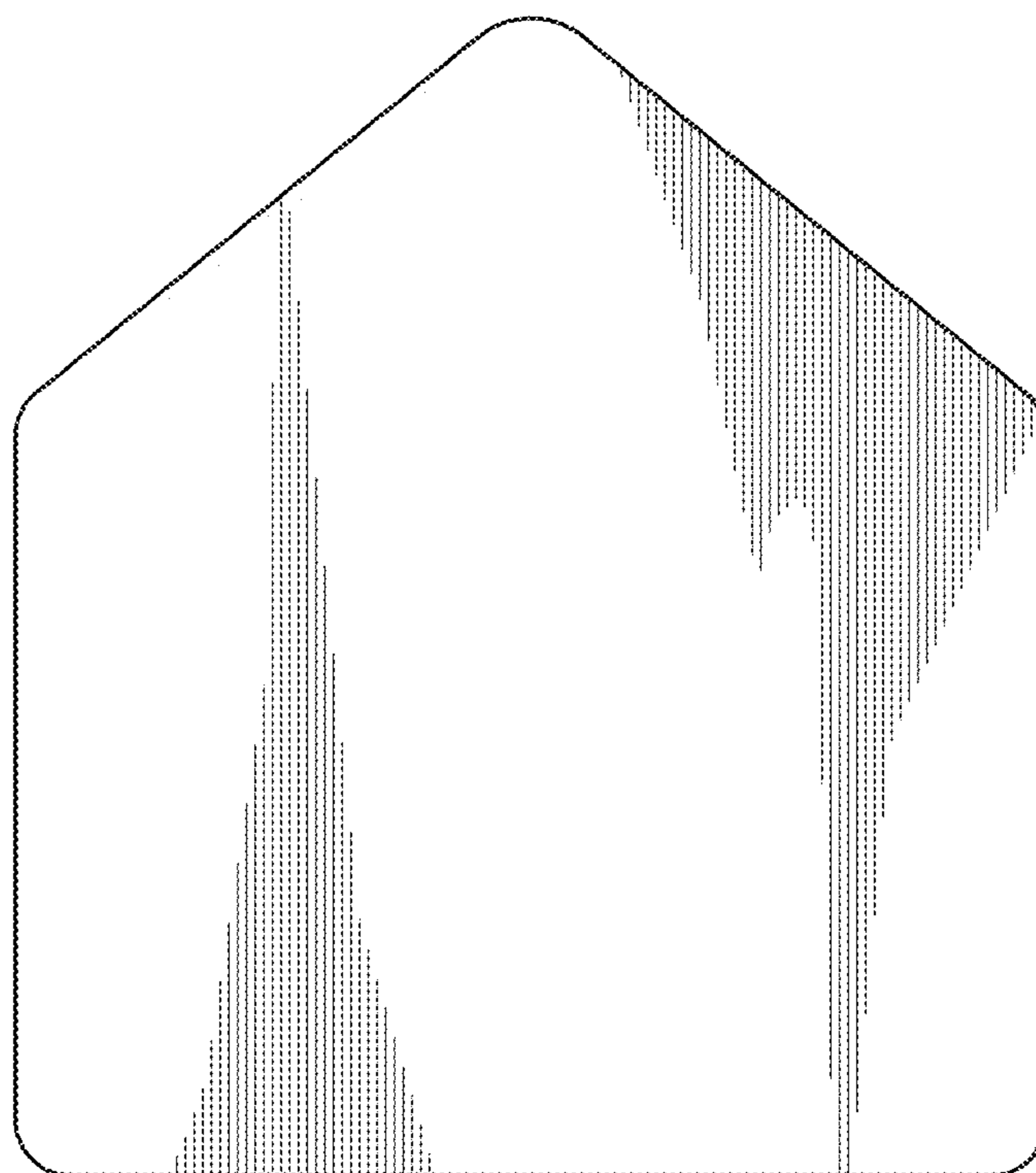




FIG. 13

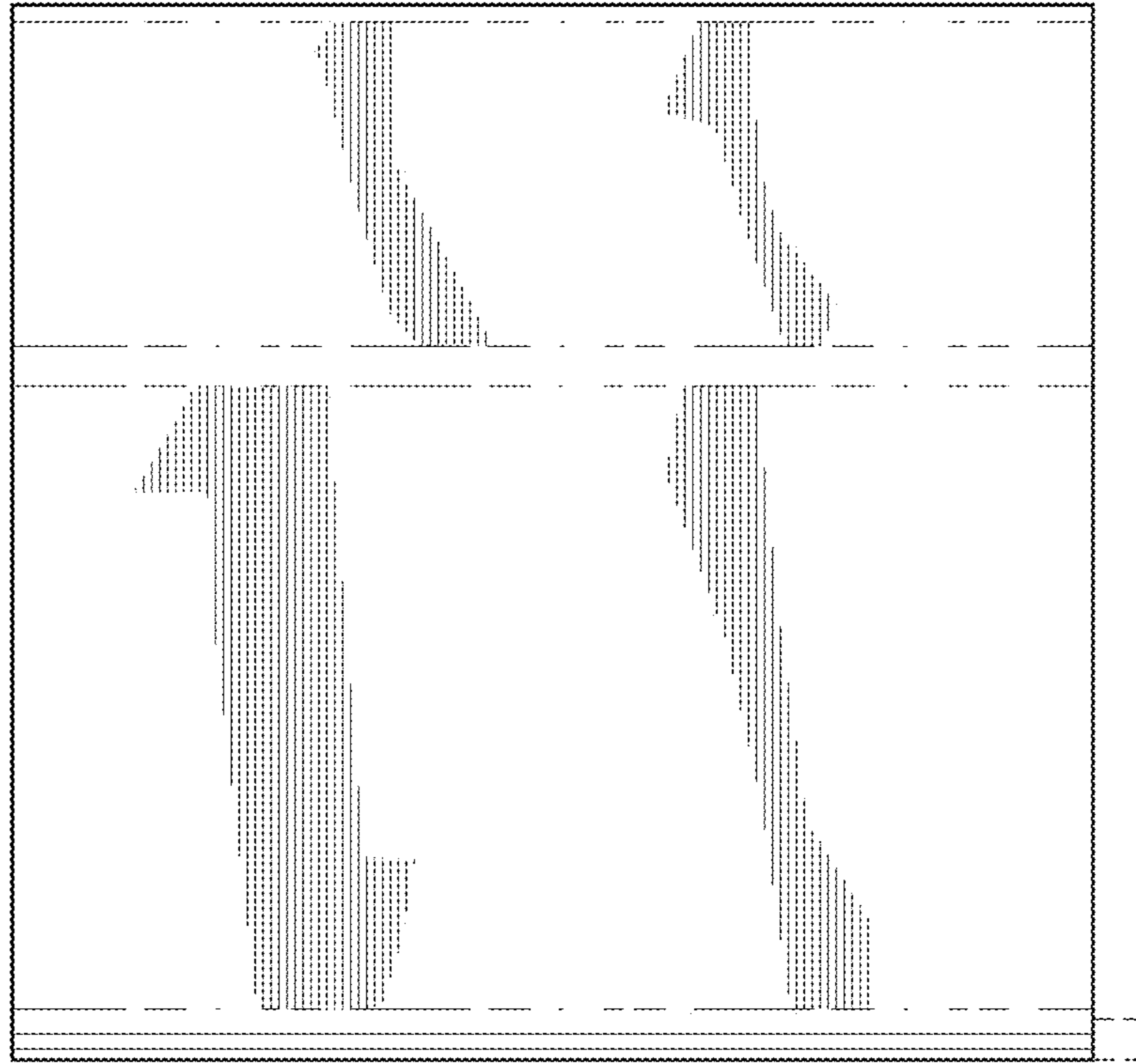


FIG. 14

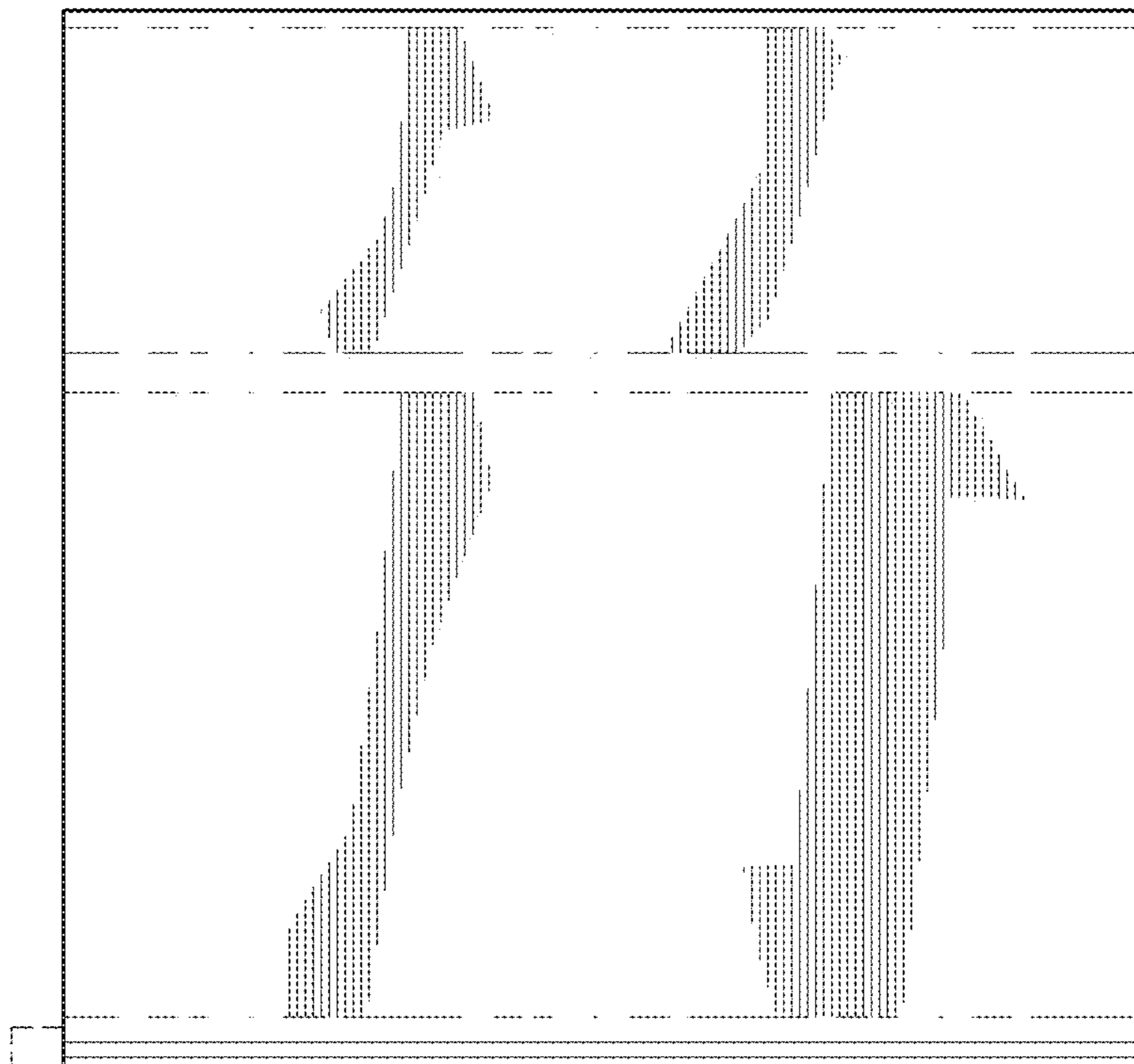


FIG. 15



FIG. 16



FIG. 17

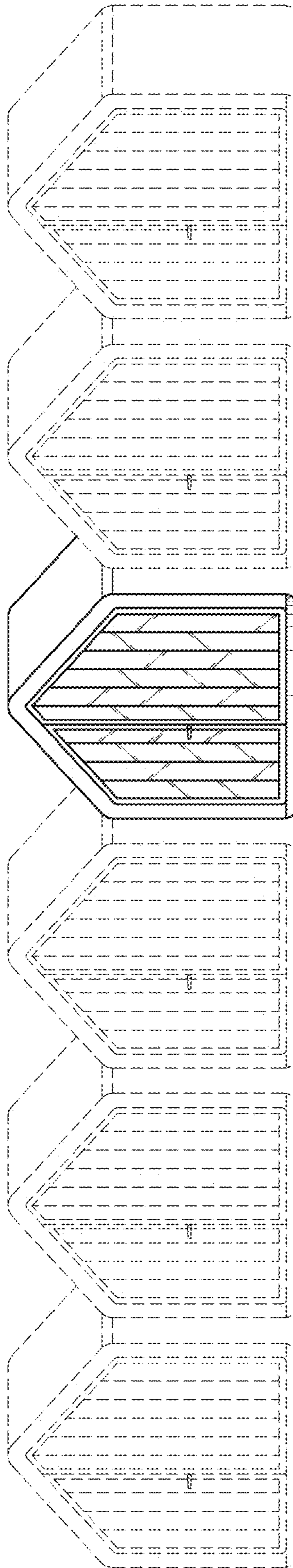


FIG. 18

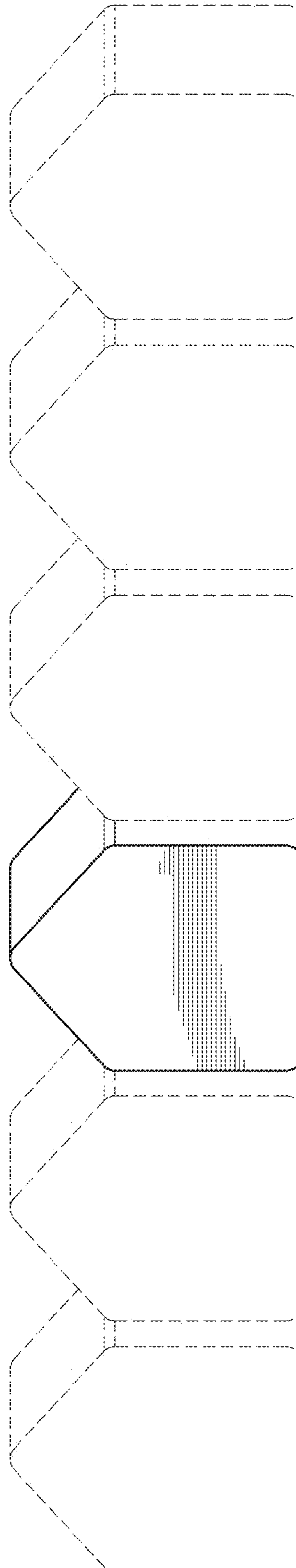


FIG. 19

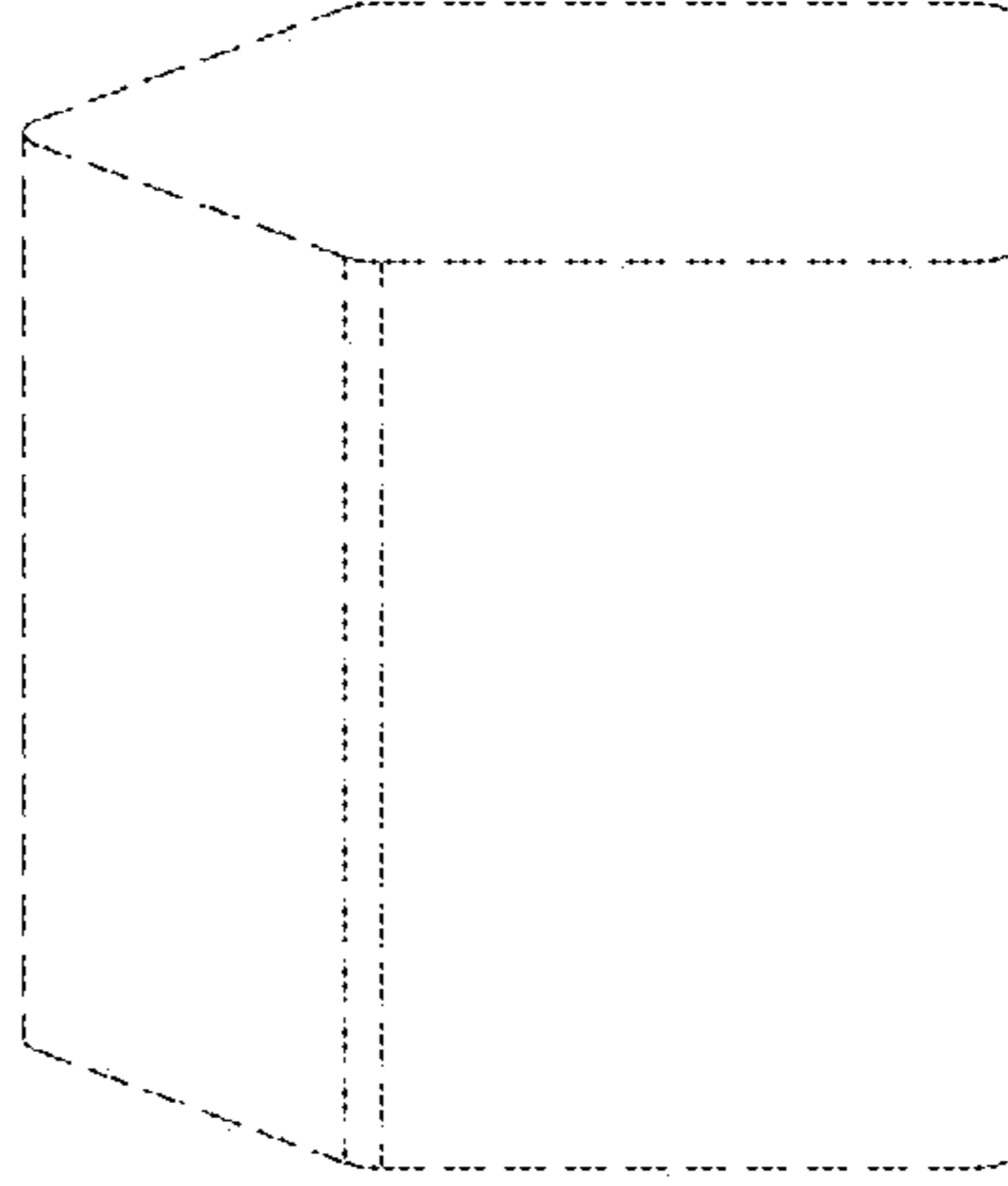
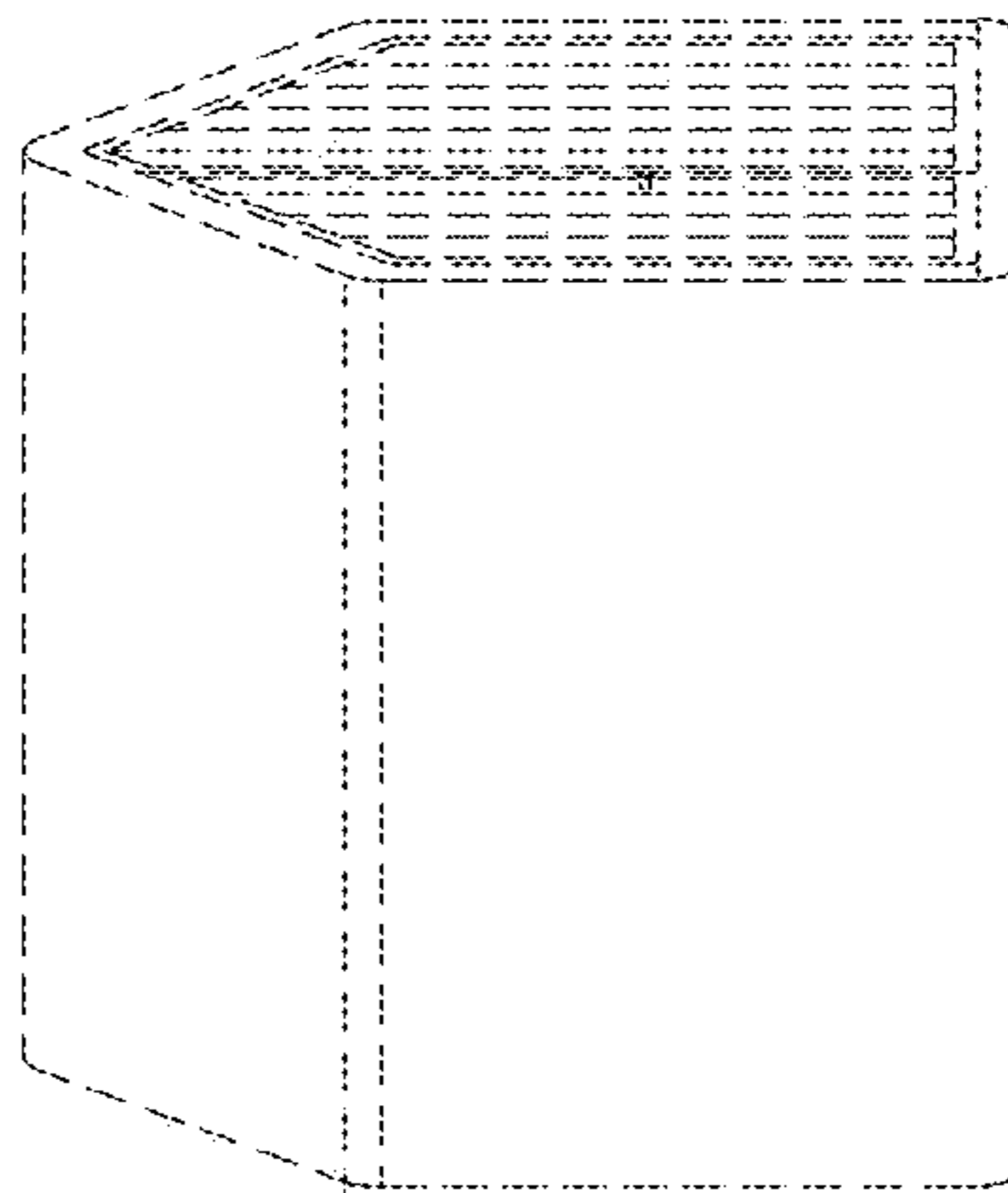


FIG. 20



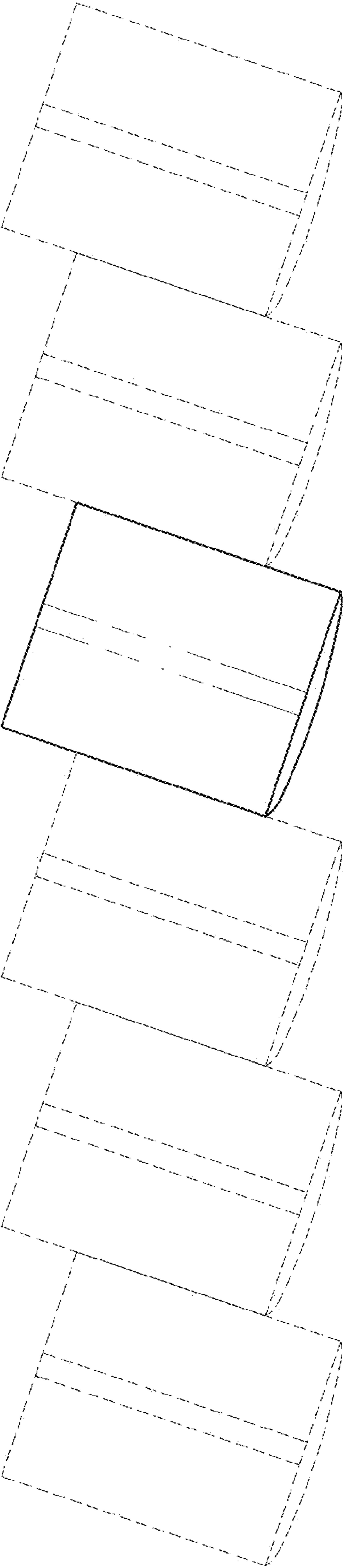


FIG. 21

FIG. 22

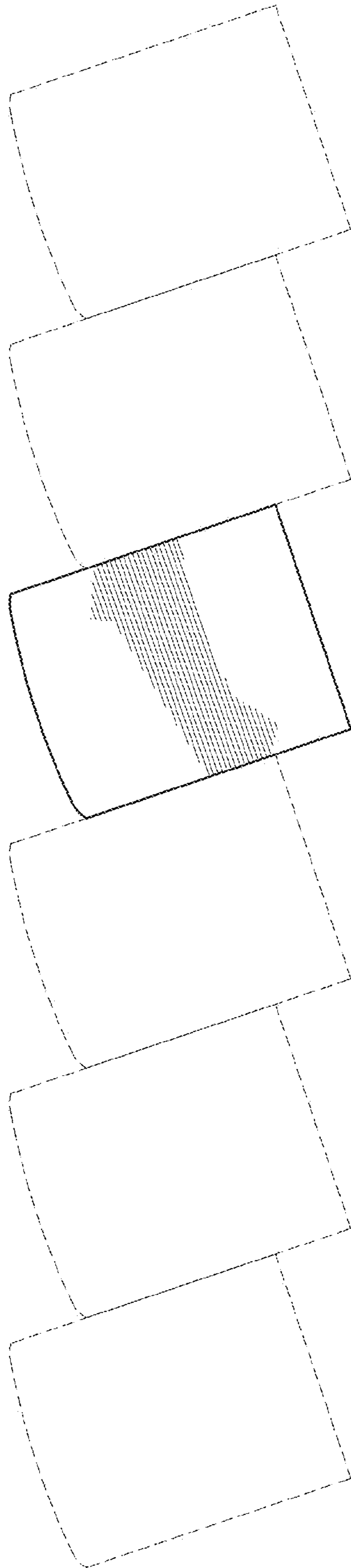
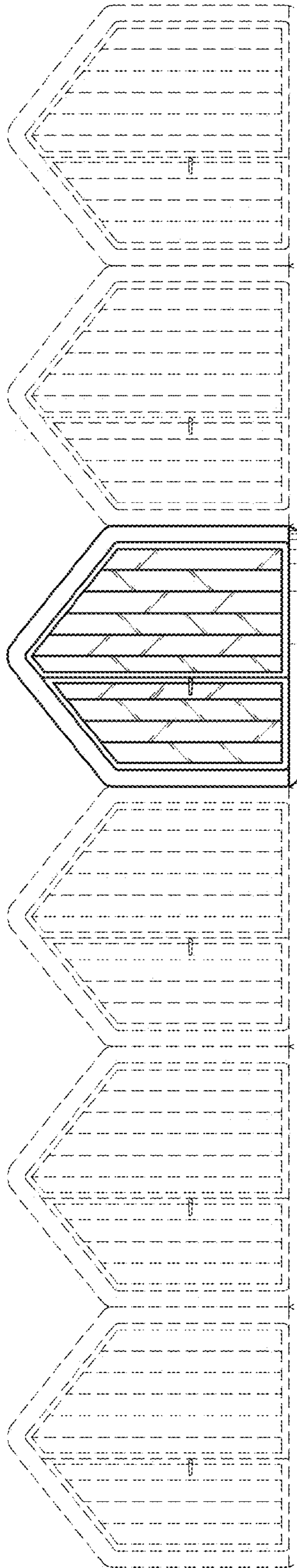


FIG. 23





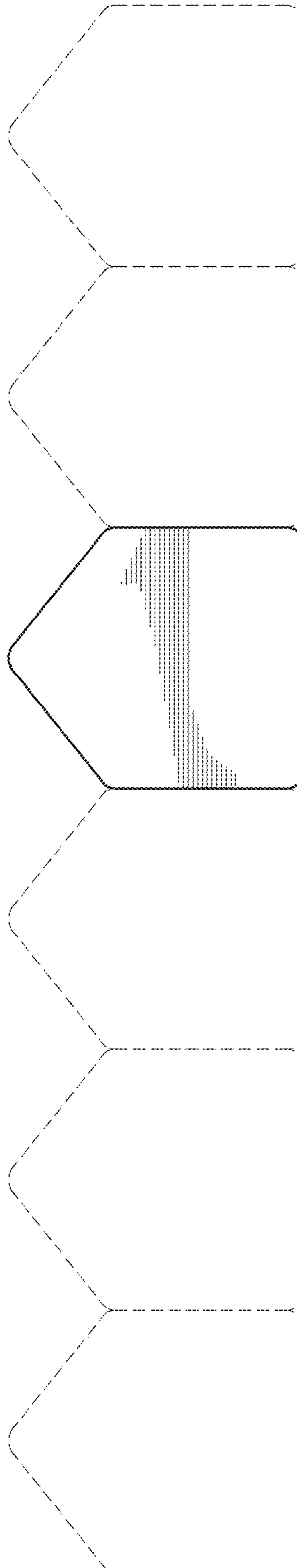


FIG. 24

FIG. 25

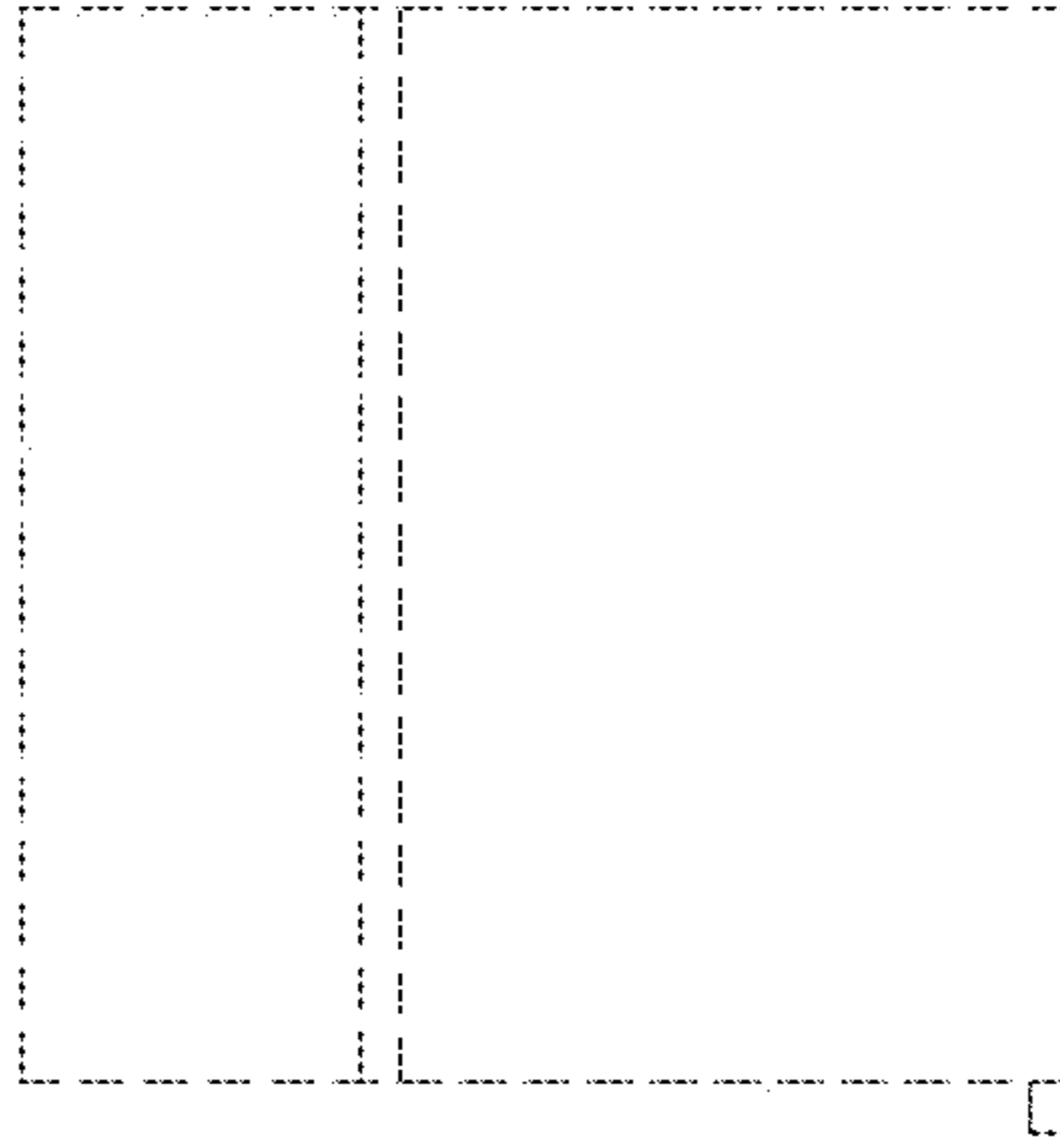
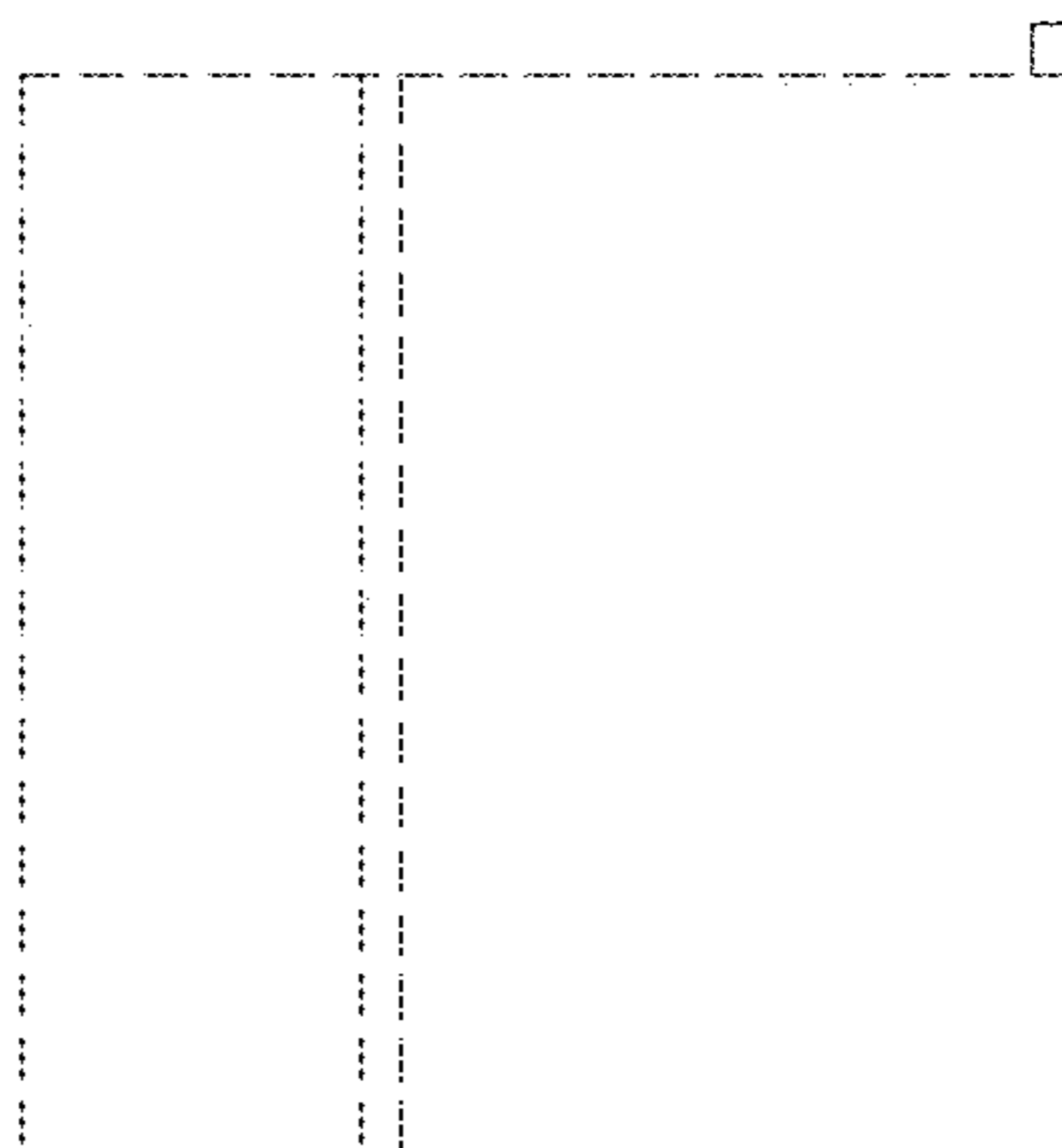


FIG. 26



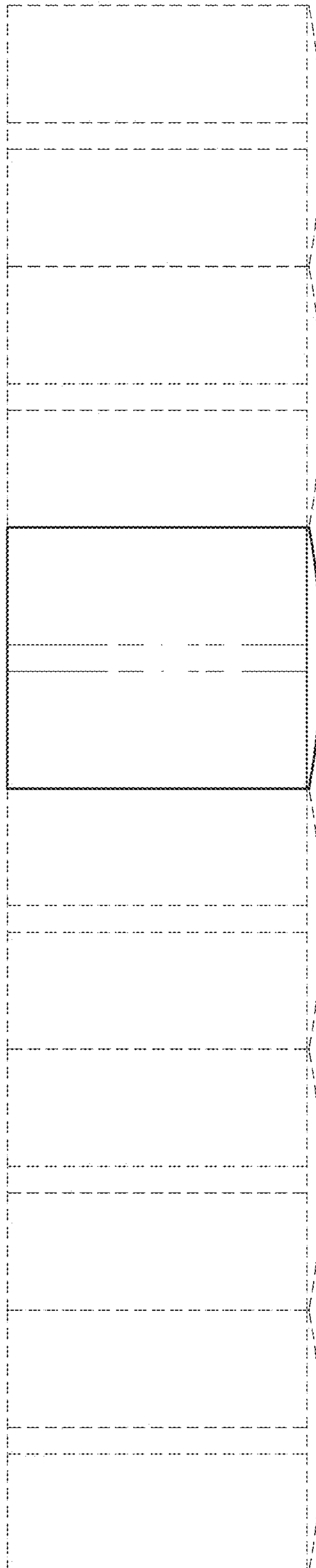


FIG. 27

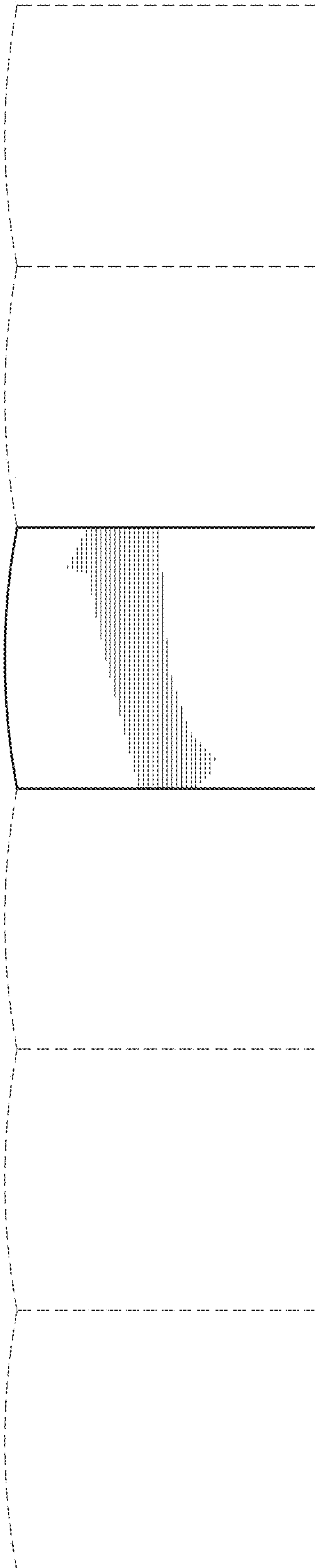


FIG. 28