



US00D918992S

(12) **United States Design Patent** (10) **Patent No.:** **US D918,992 S**
Lu (45) **Date of Patent:** **** May 11, 2021**

(54) **BABY SUNGLASSES WITH STRAP**

(71) Applicant: **Xiaolin Lu**, Yiwu (CN)

(72) Inventor: **Xiaolin Lu**, Yiwu (CN)

(**) Term: **15 Years**

(21) Appl. No.: **29/748,641**

(22) Filed: **Aug. 31, 2020**

(51) **LOC (13) Cl.** **16-06**

(52) **U.S. Cl.**
USPC **D16/311**

(58) **Field of Classification Search**
USPC 351/43, 44–47, 49, 59, 63, 69, 104, 123,
351/126, 131, 132, 135, 145; D16/101,
D16/300–342; D29/108–110; D14/372
CPC G02C 5/22; G02C 5/2218; G02C 5/2236;
G02C 5/2245; G02C 5/2254; G02C
5/2272; G02C 5/14; G02C 5/143; G02C
5/146; G02C 5/18; G02C 5/20; G02C
5/12; G02C 5/124; G02C 5/126; G02C
11/02; G02C 11/06; G02C 7/10; G02C
9/04; A61F 9/00
See application file for complete search history.

(56) **References Cited**

U.S. PATENT DOCUMENTS

1,781,760	A *	11/1930	Marciano	G02C 5/02 351/87
2,856,466	A *	10/1958	Gustafson	G02C 11/06 381/327
D202,742	S *	11/1965	Harley	D16/317
4,506,961	A *	3/1985	Palmieri	G02C 5/124 351/128
D778,978	S *	2/2017	Renon	D16/326
D780,830	S *	3/2017	Bonaventura	D16/326
D800,826	S *	10/2017	Renon	D16/326
D816,761	S *	5/2018	Lalush	D16/326
D820,347	S *	6/2018	Chae	D16/335
D857,087	S *	8/2019	Tappeiner	D16/300
D860,302	S *	9/2019	Boinnard et al.	
D864,283	S *	10/2019	Williams	D16/300

D865,040	S *	10/2019	Schaal	D16/309
D865,041	S *	10/2019	Schaal	D16/309
D870,193	S *	12/2019	Craig	D16/326
D880,572	S *	4/2020	Lu	D16/311
10,634,931	B1 *	4/2020	Zargari	A47F 7/021
D888,143	S *	6/2020	Sheldon	D16/326
D888,818	S	6/2020	Pellicer Ramo	
D889,530	S	7/2020	Boinnard et al.	

(Continued)

OTHER PUBLICATIONS

Braylenz Candy Color Sunglasses, earliest review: N/A, [online], [site visited Mar. 11, 2021], Available from Internet: (Year: 2020). <URL:https://www.amazon.com/Braylenz-Polarized-Sunglasses-Unbreakable-Glasses/dp/B08SBGST4B/ref=sr_1_1?crid=16HLYHNEK8563&dchild=1&keywords=braylenz+sunglasses+tr90&qid=1615512390&sprefix=braylenz%2Caps%2C160&sr=8-1> (Year: 2020).*

(Continued)

Primary Examiner — Sanjeev Paul
(74) *Attorney, Agent, or Firm* — ScienBiziP, P.C.

(57) **CLAIM**

The ornamental design for a baby sunglasses with strap, as shown and described.

DESCRIPTION

FIG. 1 is a front perspective view of a baby sunglasses with strap, showing my design.
FIG. 2 is a rear perspective view thereof.
FIG. 3 is a front elevation view thereof.
FIG. 4 is a rear elevation view thereof.
FIG. 5 is a left side elevation view thereof.
FIG. 6 is a right side elevation view thereof.
FIG. 7 is a top plan view thereof; and,
FIG. 8 is a bottom plan view thereof.
The broken lines in the drawings depict environmental structure and boundaries and form no part of the claimed design.

1 Claim, 8 Drawing Sheets

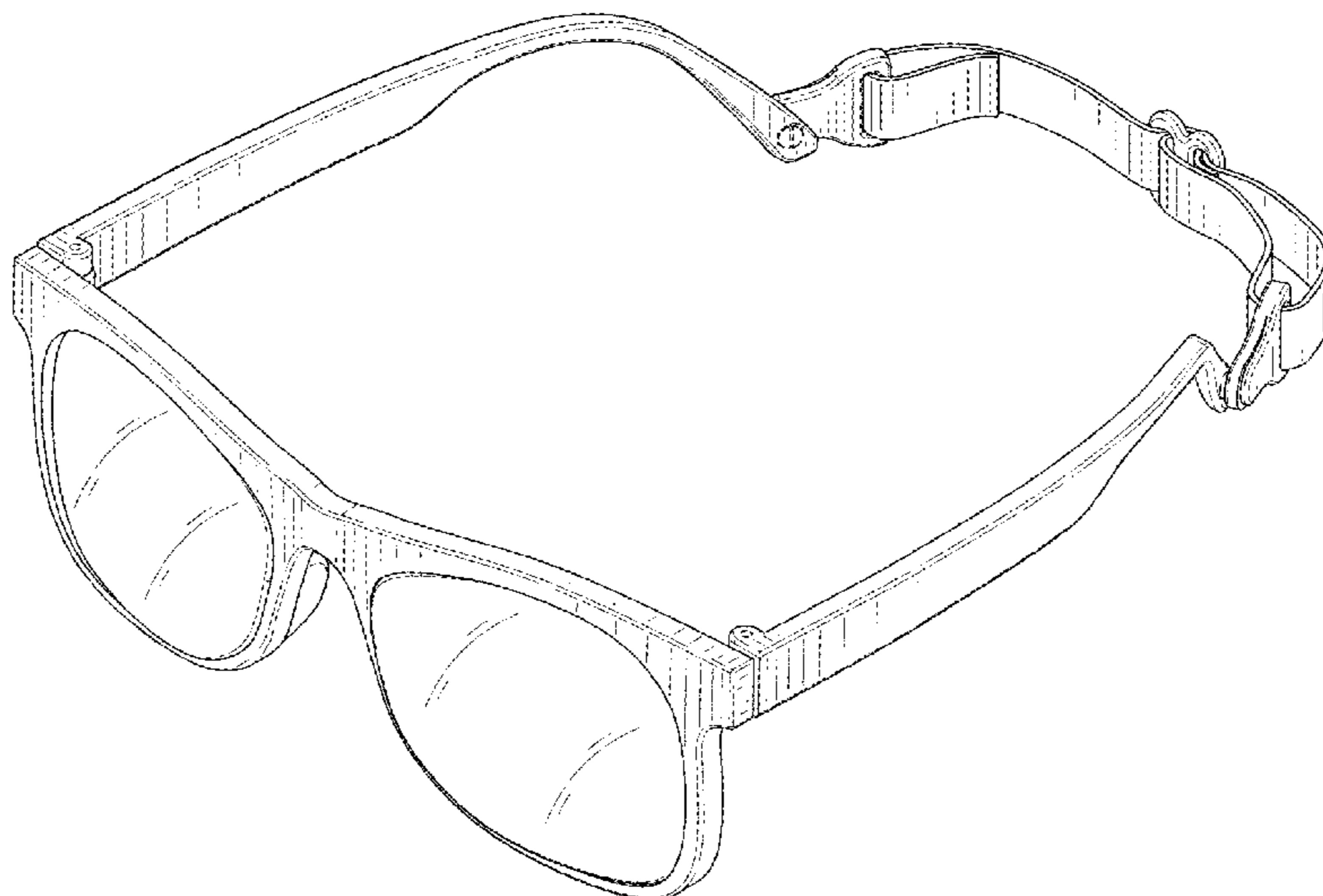

(56)

References Cited

U.S. PATENT DOCUMENTS

2015/0226985 A1* 8/2015 Jones G02C 3/006
351/121
2017/0146816 A1* 5/2017 Chen G02C 5/143
2017/0208289 A1* 7/2017 Feller H04R 1/028
2019/0302474 A1* 10/2019 Bogusky G02C 5/143

OTHER PUBLICATIONS

COCOSAND Baby Sunglasses with Strap, earliest review Mar. 14, 2019, [online], [site visited Mar. 11, 2021], Available from Internet, (Year: 2019). <URL: https://www.amazon.com/COCOSAND-Navigator-Toddler-Sunglasses-0-24months/dp/B07GZWY3GT/ref=as_li_ss_tl?ie=UTF8&linkCode=ll_1&tag=sm-babysunglasses-20&linkId=40bfa62e3668129f95850756d1e3855d&language=en_US> (Year: 2019).*

Google search: "child+sunglasses" [site visited Mar. 11, 2021]: https://www.google.com/search?q=baby+sunglasses&sxsrf=ALeKk001uKB_kZHxOIFKULBpH9leX5FRyw:1615511504356&source=lnms&tbm=isch&sa=X&ved=2ahUKEwiHtuOqyanvAhXCrVkkHfMmA2wQ_AUoAnoECBcQBA&biw=1200&bih=1809#imgrc=aHEmPI7bQxyCiM (Year: 2021).*

Google search: "infant+sunglasses" [site visited Mar. 11, 2021]: https://www.google.com/search?q=infant%2Bsunglasses&sxsrf=ALeKk00GJ6dUBCP7yxScOoVg2Xj5JZzUeg:1603479768650&source=lnms&tbm=isch&sa=X&ved=2ahUKEwjN9Y7Qs8vsAhXelHIEHe6IAuwQ_AUoAnoECCYQBA&biw=1200&bih=1777 (Year: 2020).*

* cited by examiner

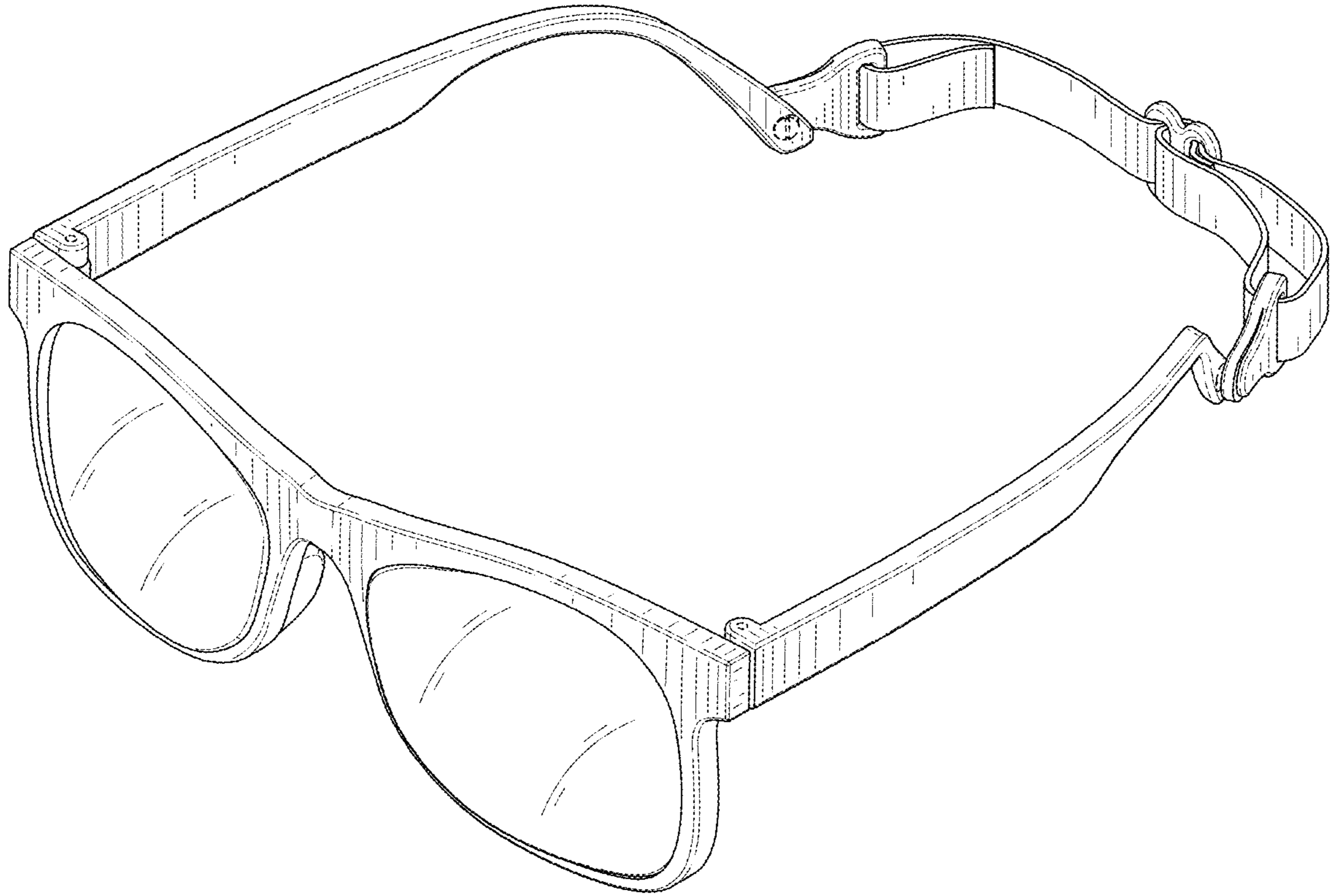

FIG. 1

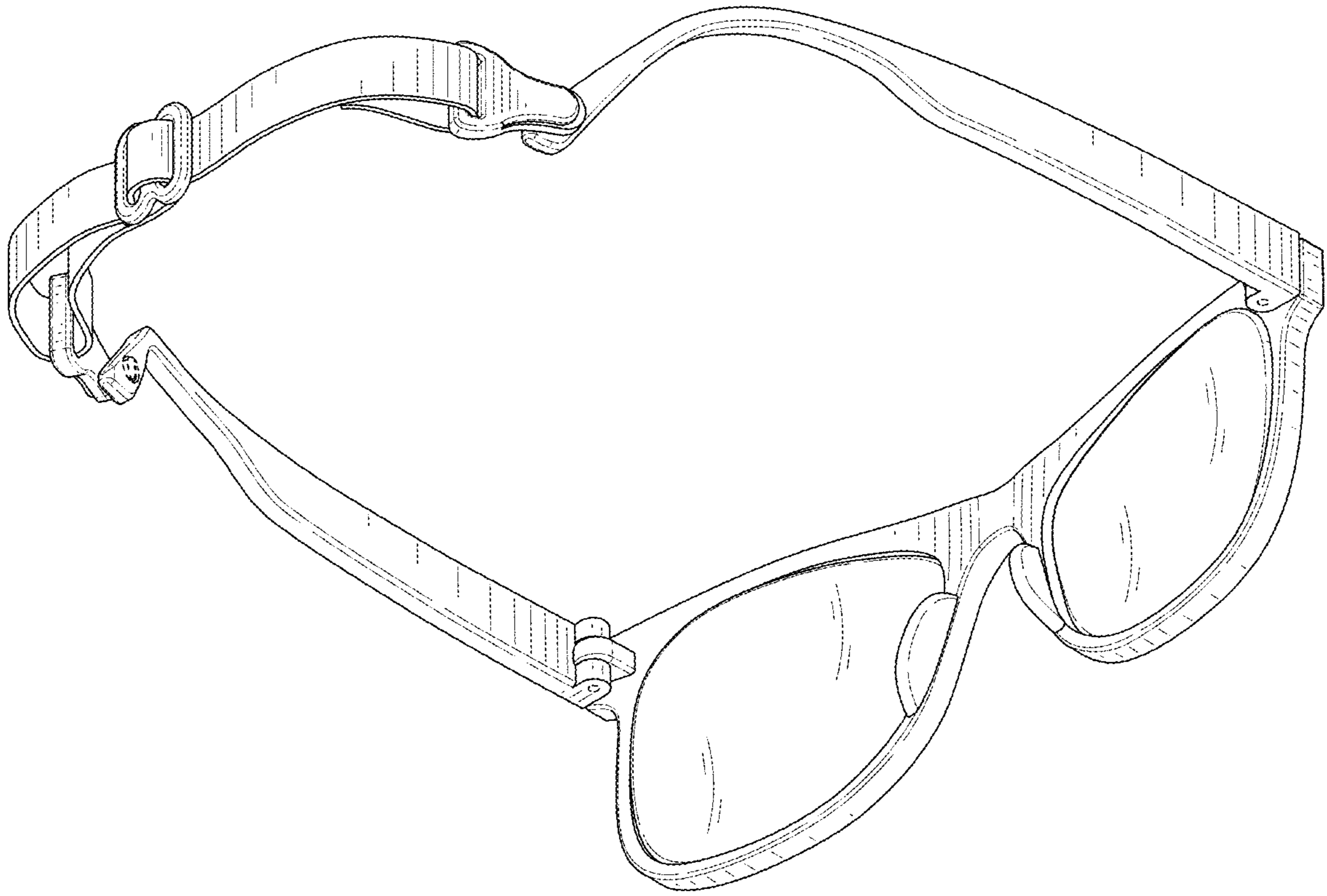

FIG. 2

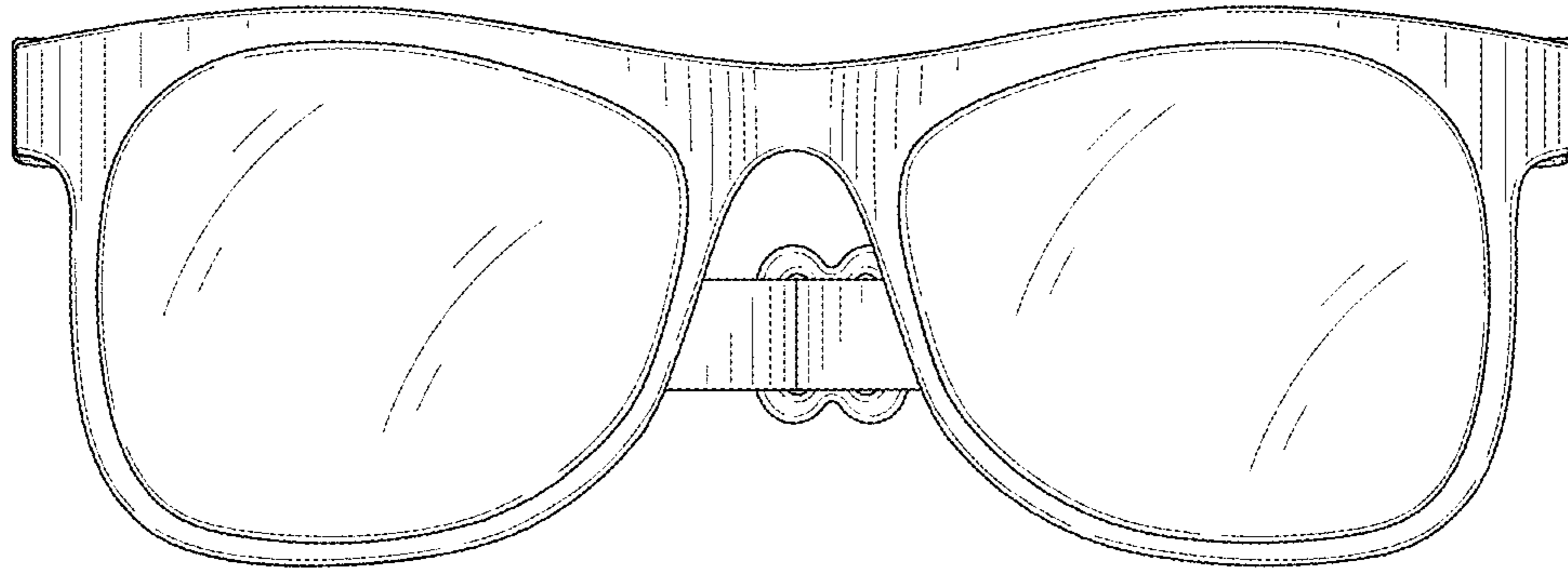

FIG. 3

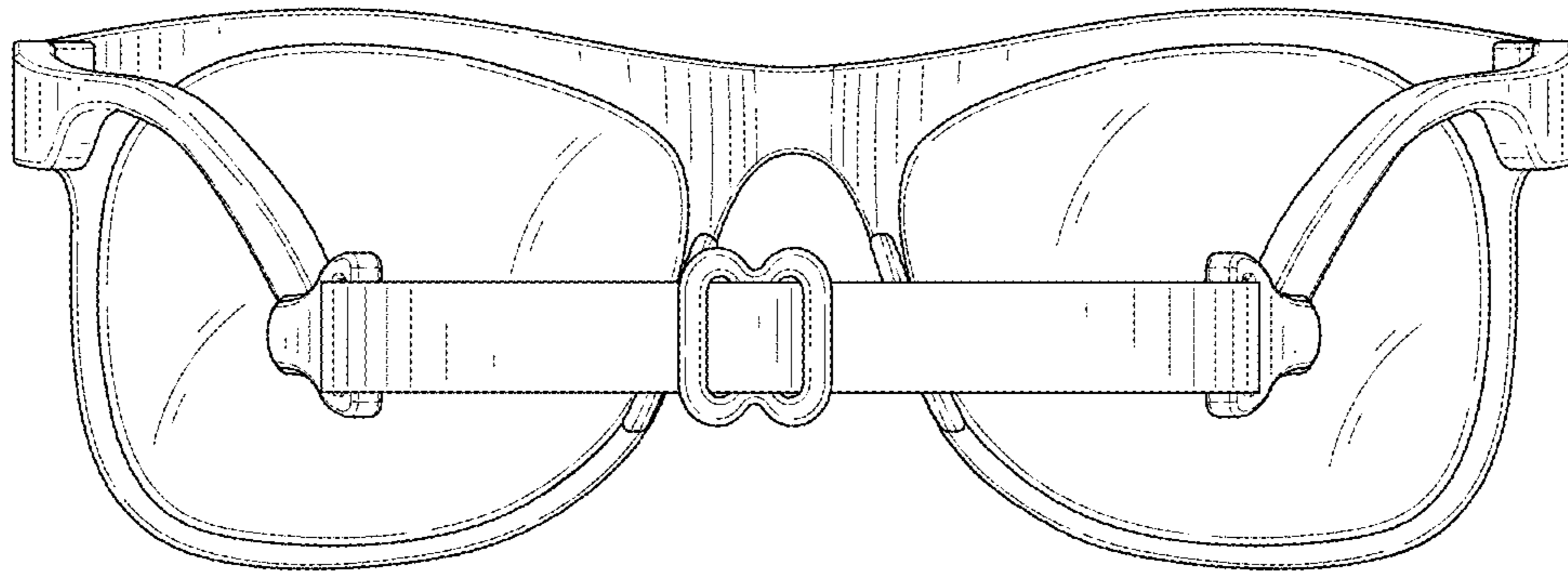

FIG. 4

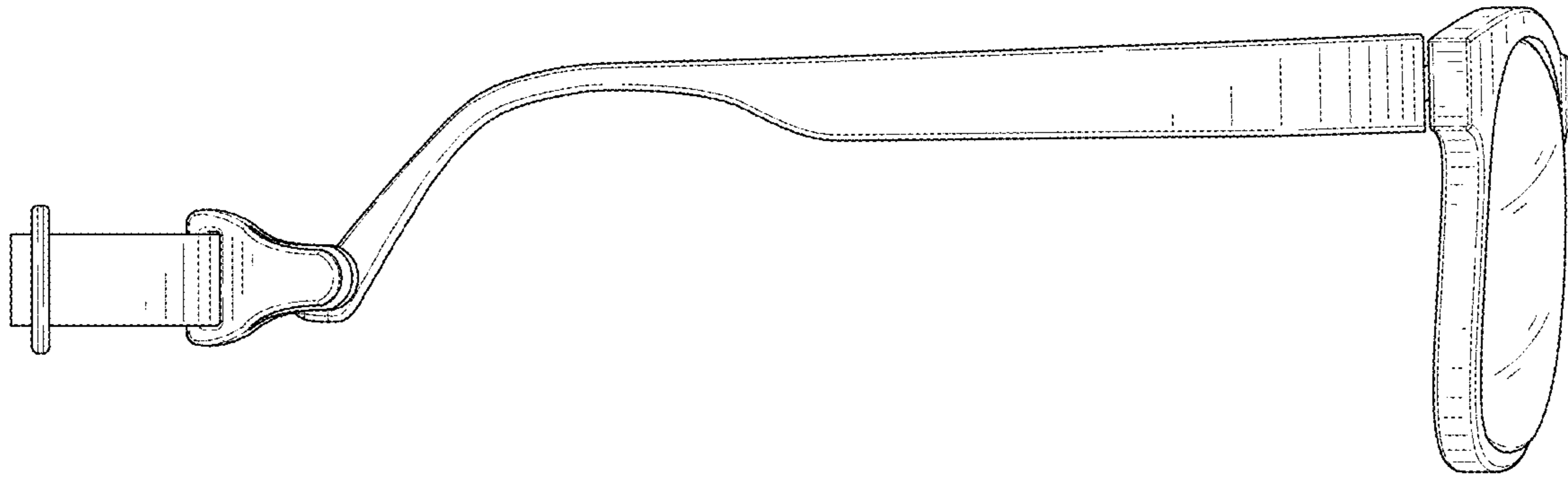

FIG. 5

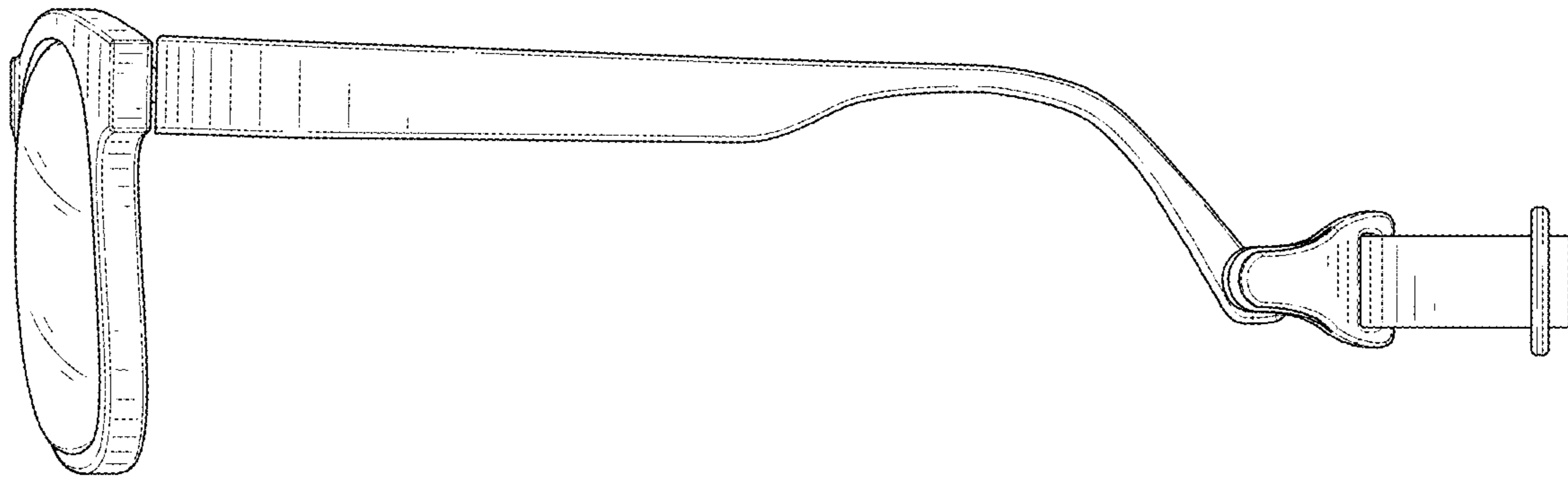

FIG. 6

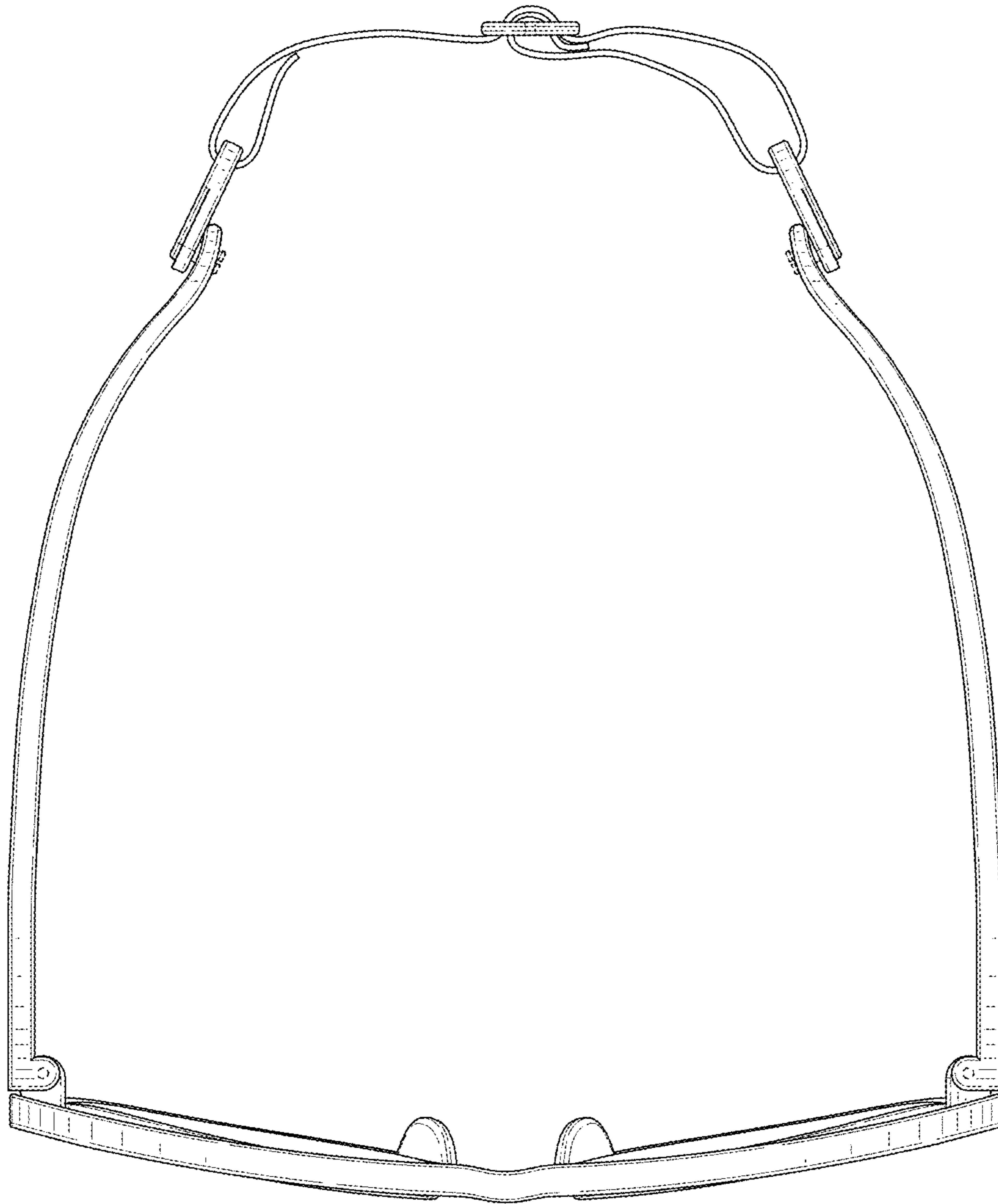

FIG. 7

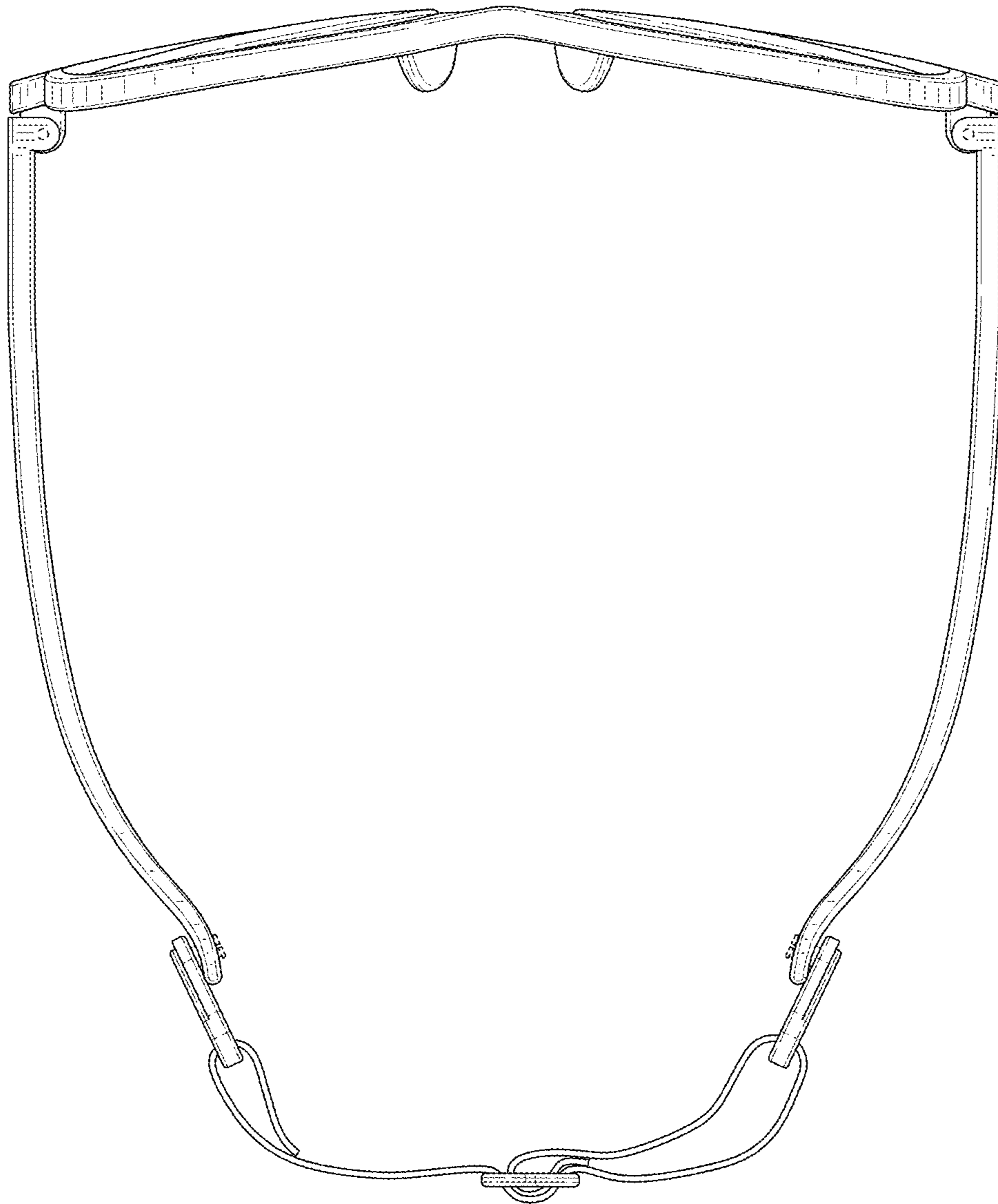

FIG. 8