



US00D918971S

(12) **United States Design Patent** (10) **Patent No.:** **US D918,971 S**
Reyes et al. (45) **Date of Patent:** **** May 11, 2021**

(54) **GRINDER** 8,393,563 B2 * 3/2013 Chaoui B02C 18/24
 241/168
 (71) Applicant: **G&E Innovations, Inc.**, Manhattan Beach, CA (US) D762,091 S * 7/2016 Grumbacher D7/679
 D804,093 S * 11/2017 Chen D27/195
 D814,251 S * 4/2018 Muller D7/679
 (72) Inventors: **Gustavo Reyes**, Sarasota, FL (US); D833,673 S * 11/2018 Booth D27/194
Esther Delgado-Lago, Redondo Beach, CA (US) D853,803 S * 7/2019 Zhang D7/679
 D862,537 S * 10/2019 Larose D15/123
 2013/0214068 A1 * 8/2013 Camitta B02C 18/24
 241/25

(73) Assignee: **G&E INNOVATIONS, INC.**, Manhattan Beach, CA (US)

* cited by examiner

(**) Term: **15 Years**

Primary Examiner — Khawaja Anwar

(74) Attorney, Agent, or Firm — Aura IP Law, PC

(21) Appl. No.: **29/669,652**

(22) Filed: **Nov. 9, 2018**

(51) **LOC (13) Cl.** **15-03**

(52) **U.S. Cl.**

USPC **D15/124**

(58) **Field of Classification Search**

USPC D15/123; D7/679, 590–600; D27/189, D27/186, 187, 194

CPC B24B 23/028; B24B 23/005; B24B 23/08; B24B 27/0084; B24B 27/02; B24B 27/04; B24B 3/34; B24B 49/006; B24B 49/12; B24B 49/183; B24B 55/00; B24B 9/007

See application file for complete search history.

(56) **References Cited**

U.S. PATENT DOCUMENTS

795,746 A * 7/1905 Wingfield et al. A24F 15/18
 206/238
 D474,378 S * 5/2003 Brandenburg D7/679
 6,945,486 B2 * 9/2005 Teng A47J 19/06
 241/169.1
 8,220,732 B2 * 7/2012 Griffin A47J 43/04
 241/169.1

(57) **CLAIM**

The ornamental design for a grinder, as shown and described.

DESCRIPTION

FIG. 1 is a top perspective view of a first embodiment of a grinder embodying the new design.

FIG. 2 is a first bottom perspective view thereof.

FIG. 3 is a second bottom perspective view thereof taken from the opposite side of FIG. 2.

FIG. 4 is a front view thereof.

FIG. 5 is a rear view thereof.

FIG. 6 is a first side view thereof.

FIG. 7 is a second side view thereof taken from the opposite side of FIG. 6.

FIG. 8 is a top view thereof; and,

FIG. 9 is a bottom view thereof.

All features in broken lines are for the purpose of illustrating environmental structure and form no part of the claimed subject matter.

1 Claim, 9 Drawing Sheets

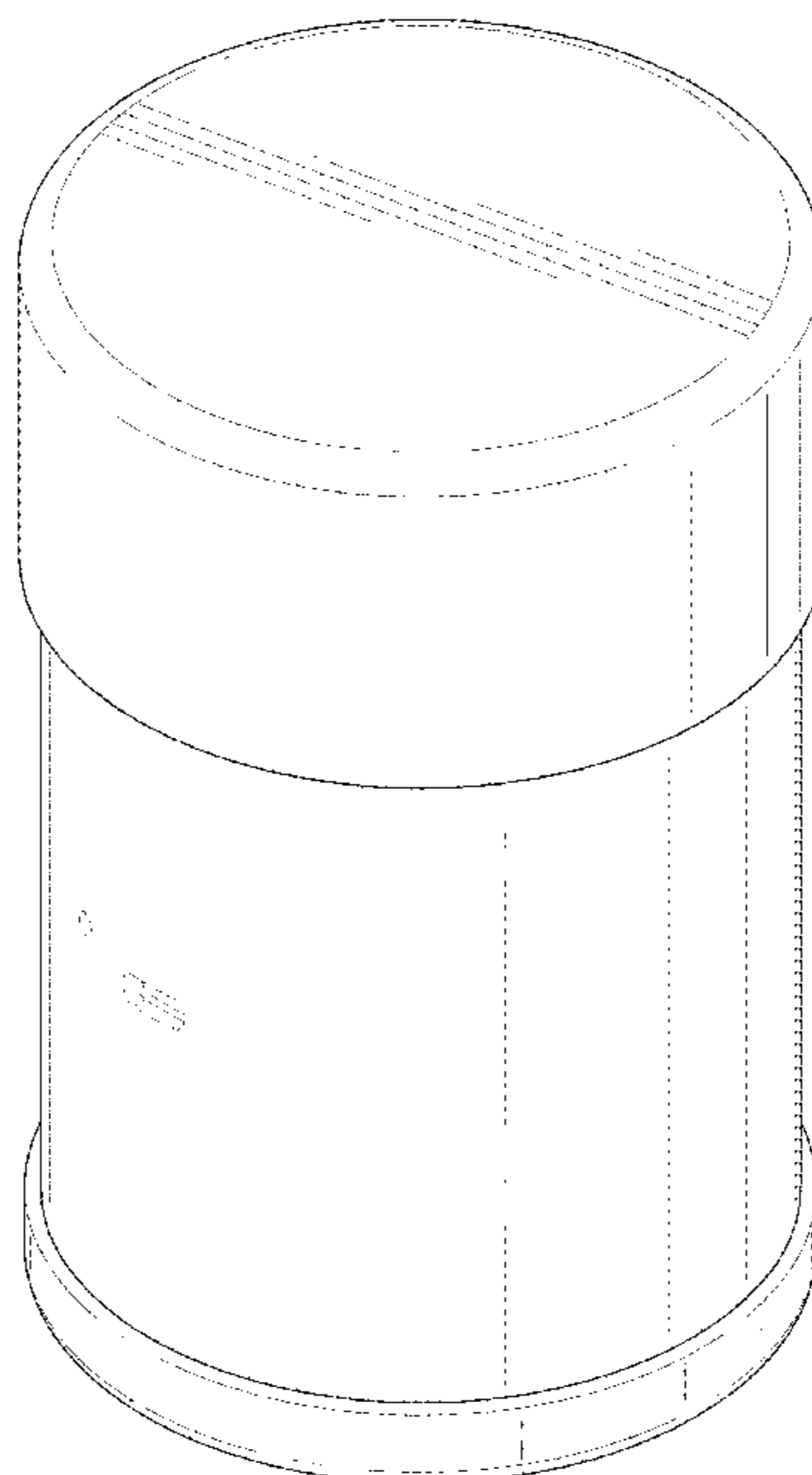

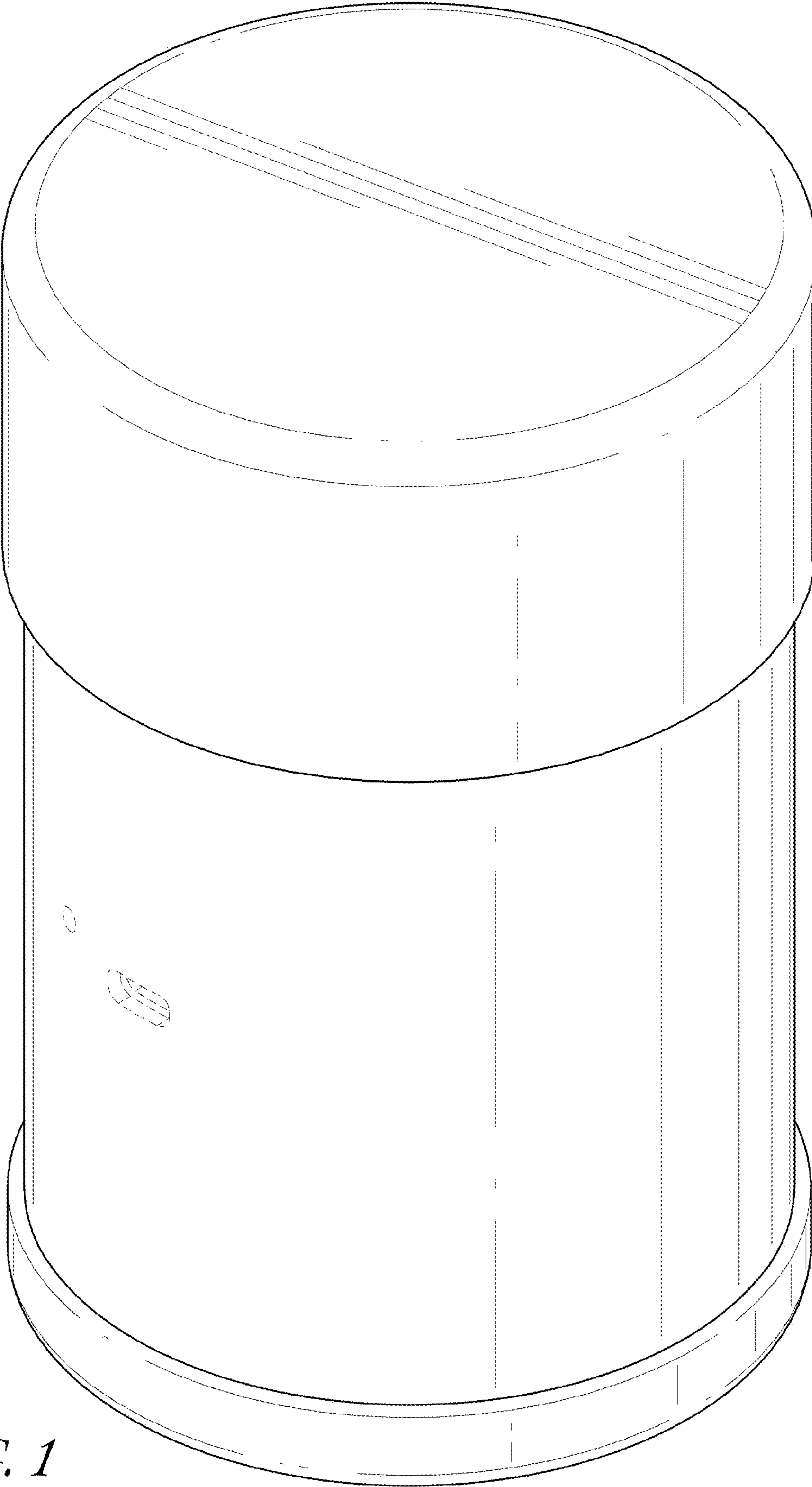

FIG. 1

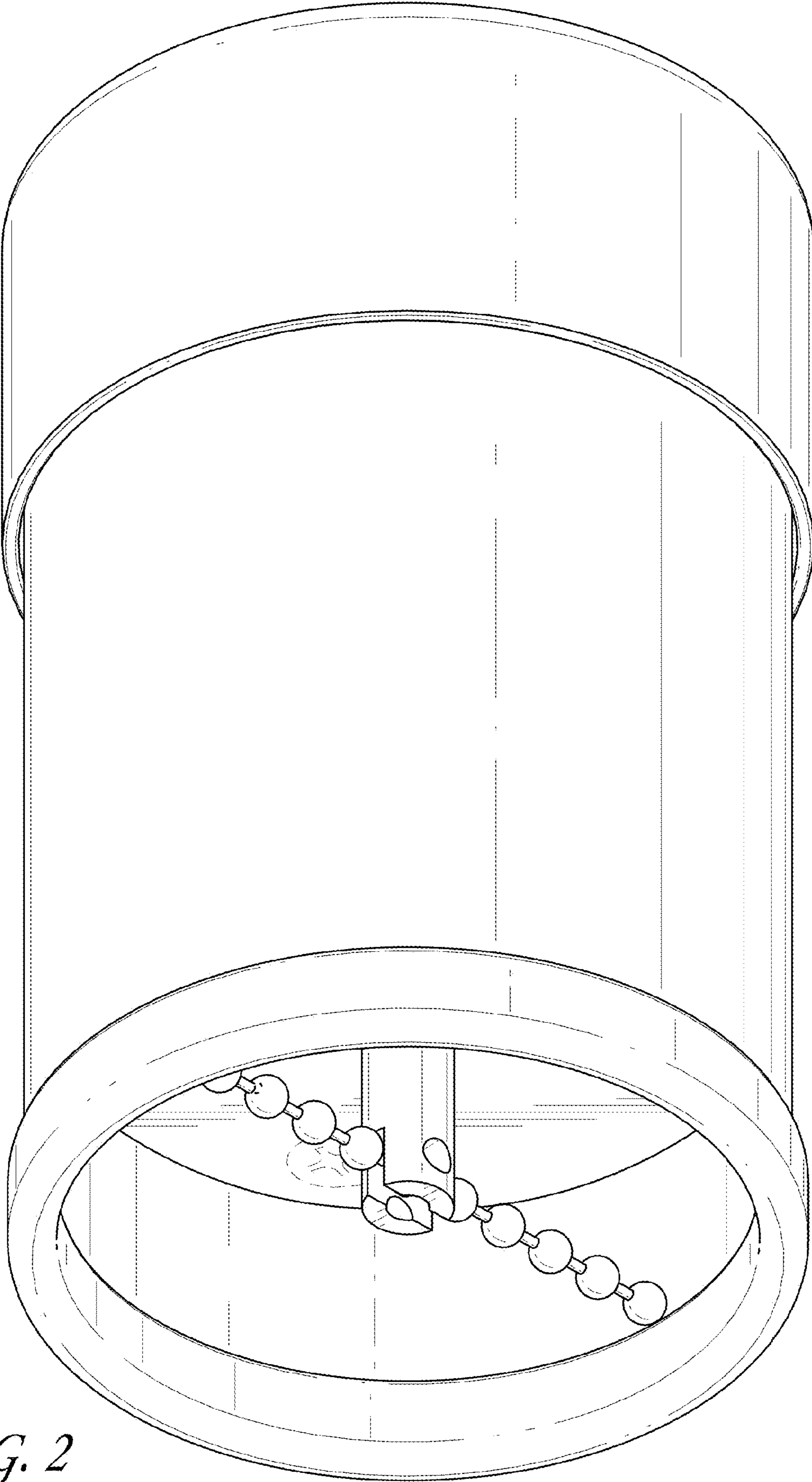

FIG. 2

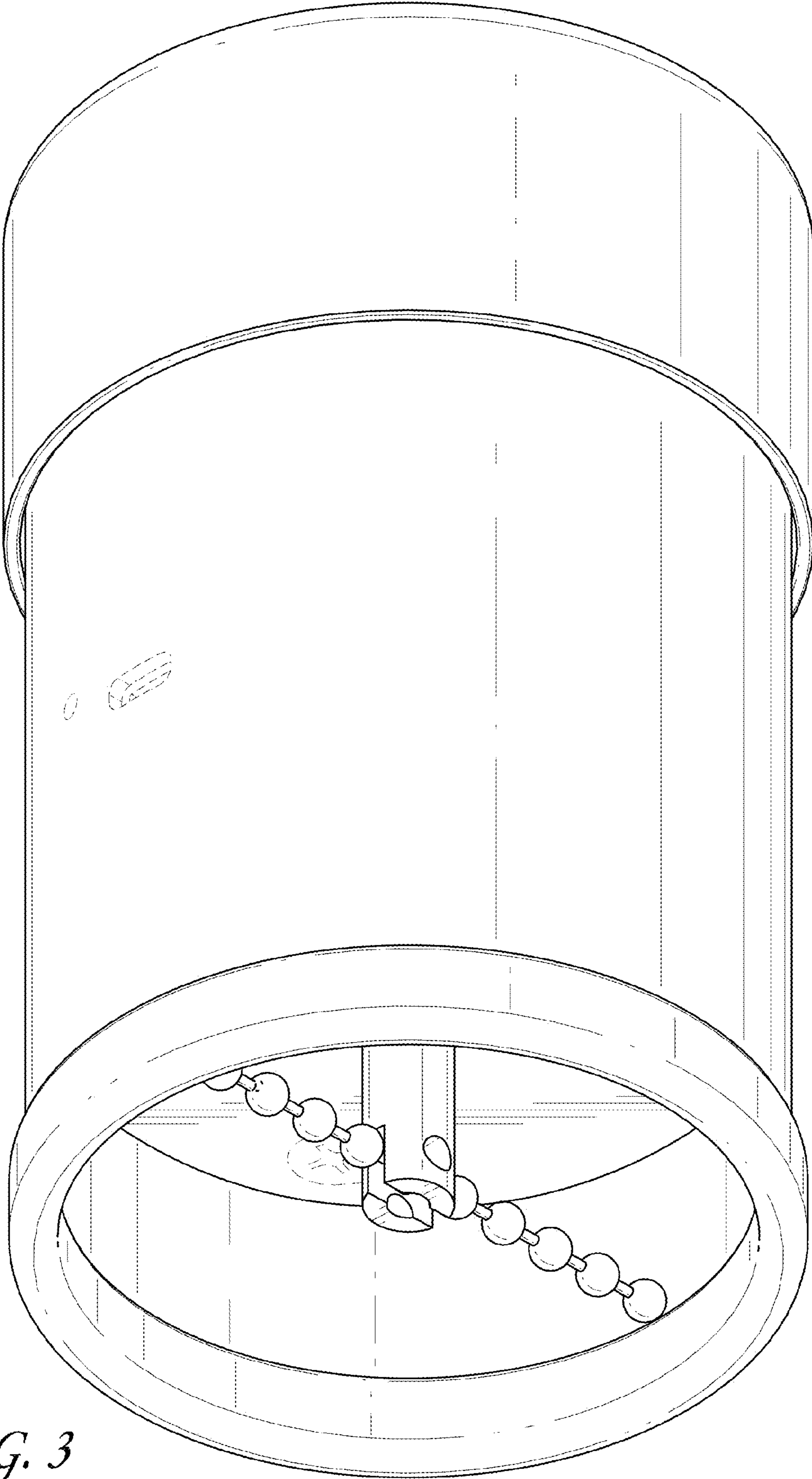

FIG. 3

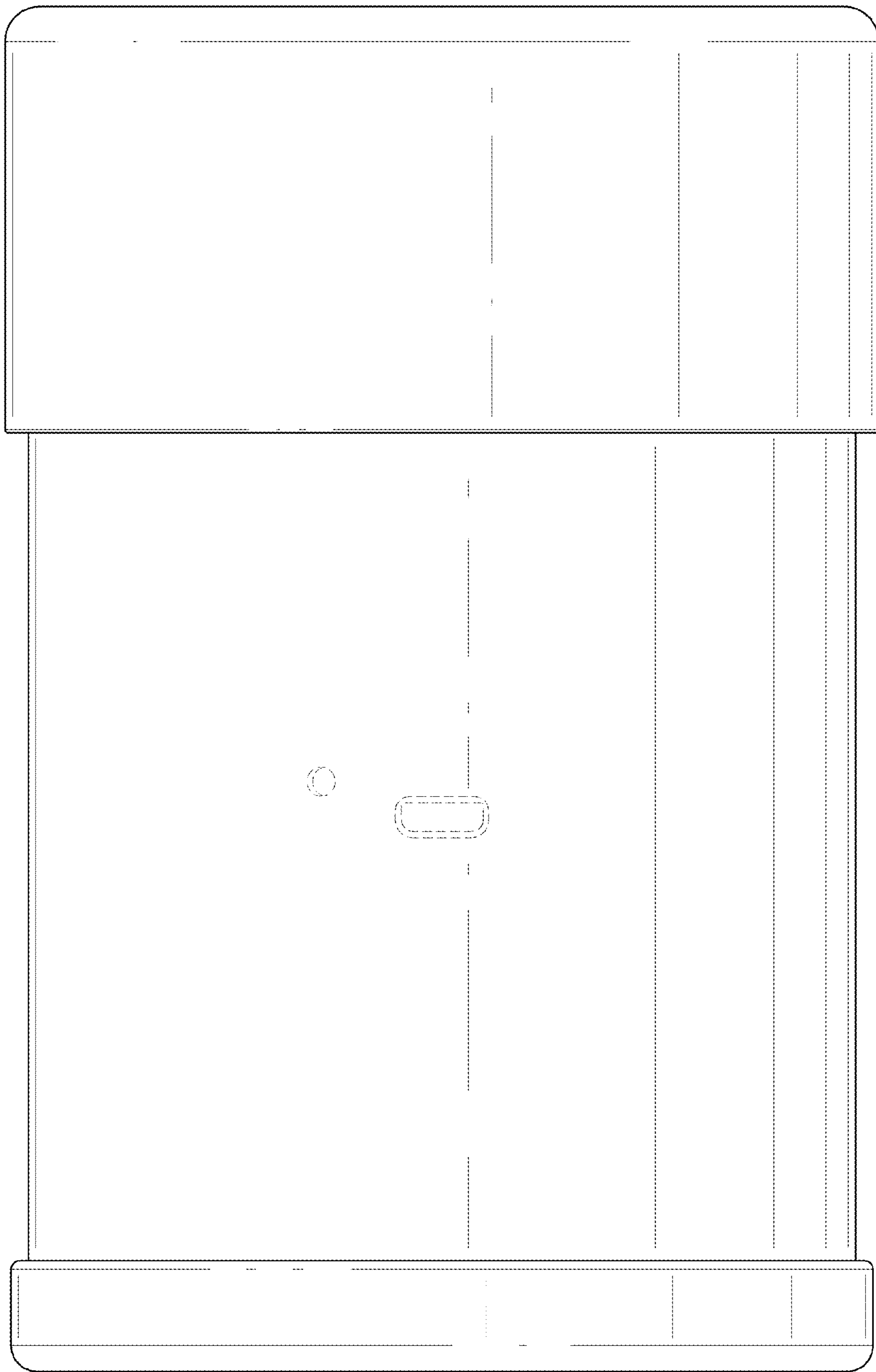

FIG. 4

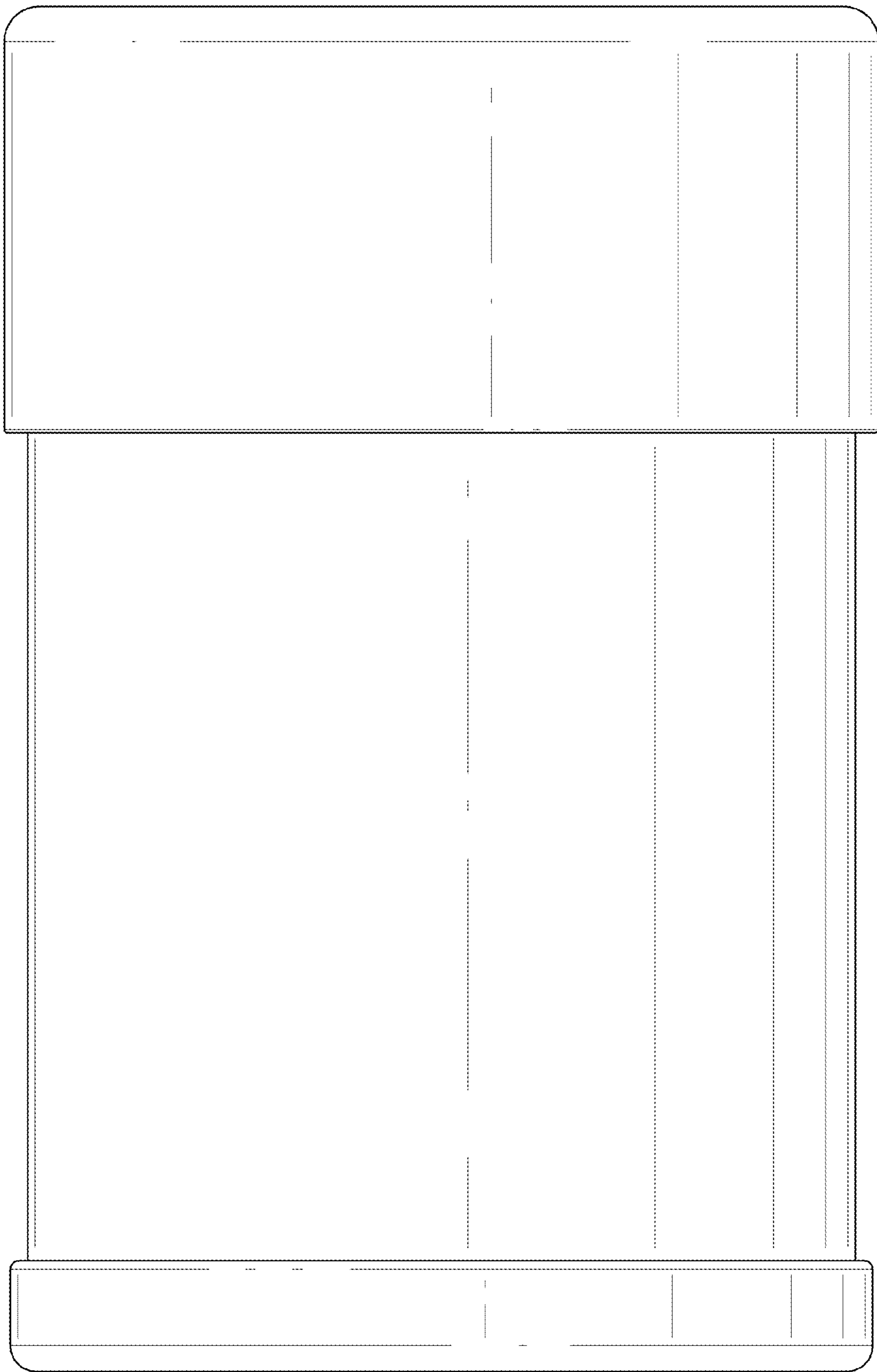

FIG. 5

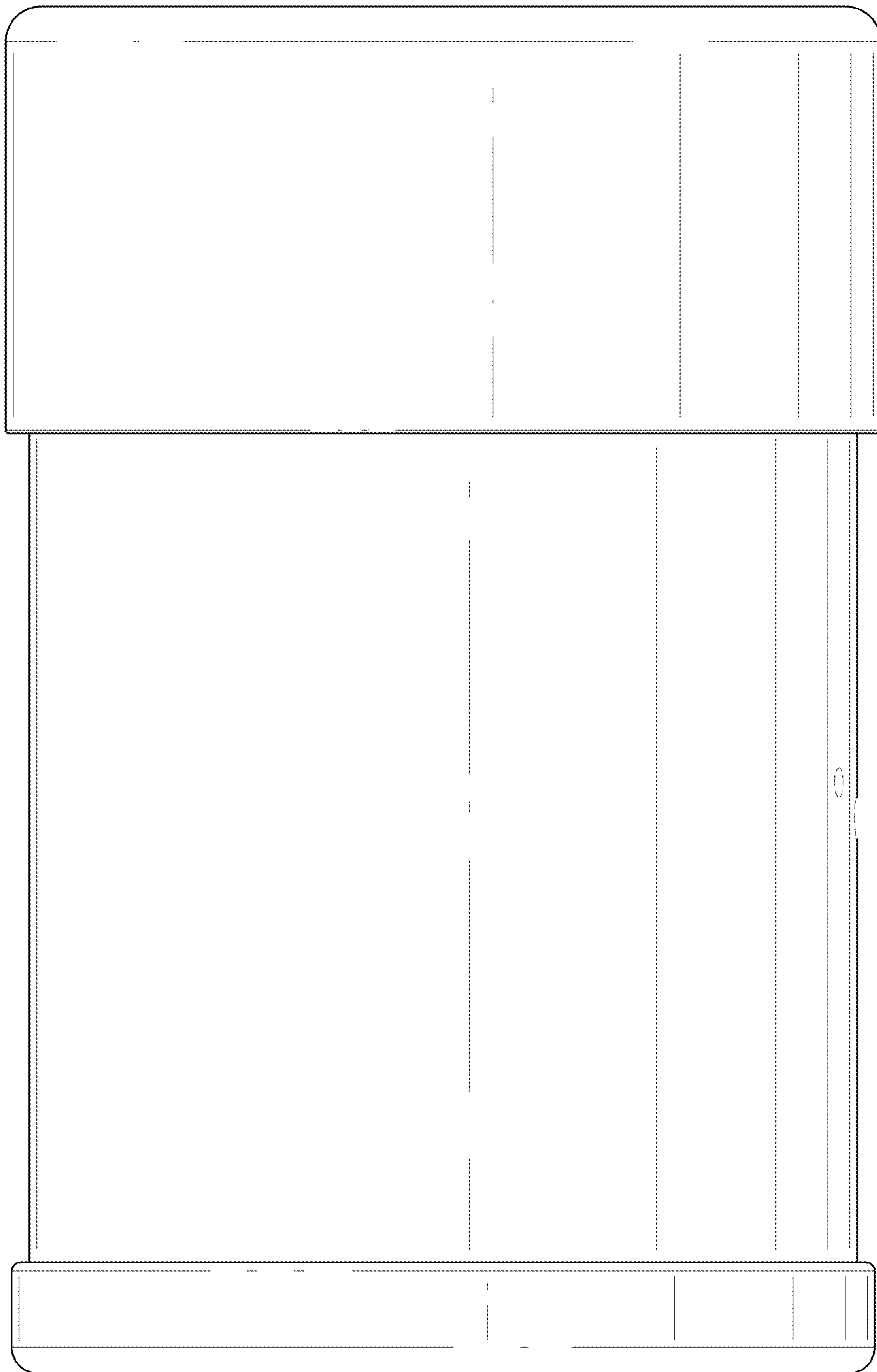

FIG. 6

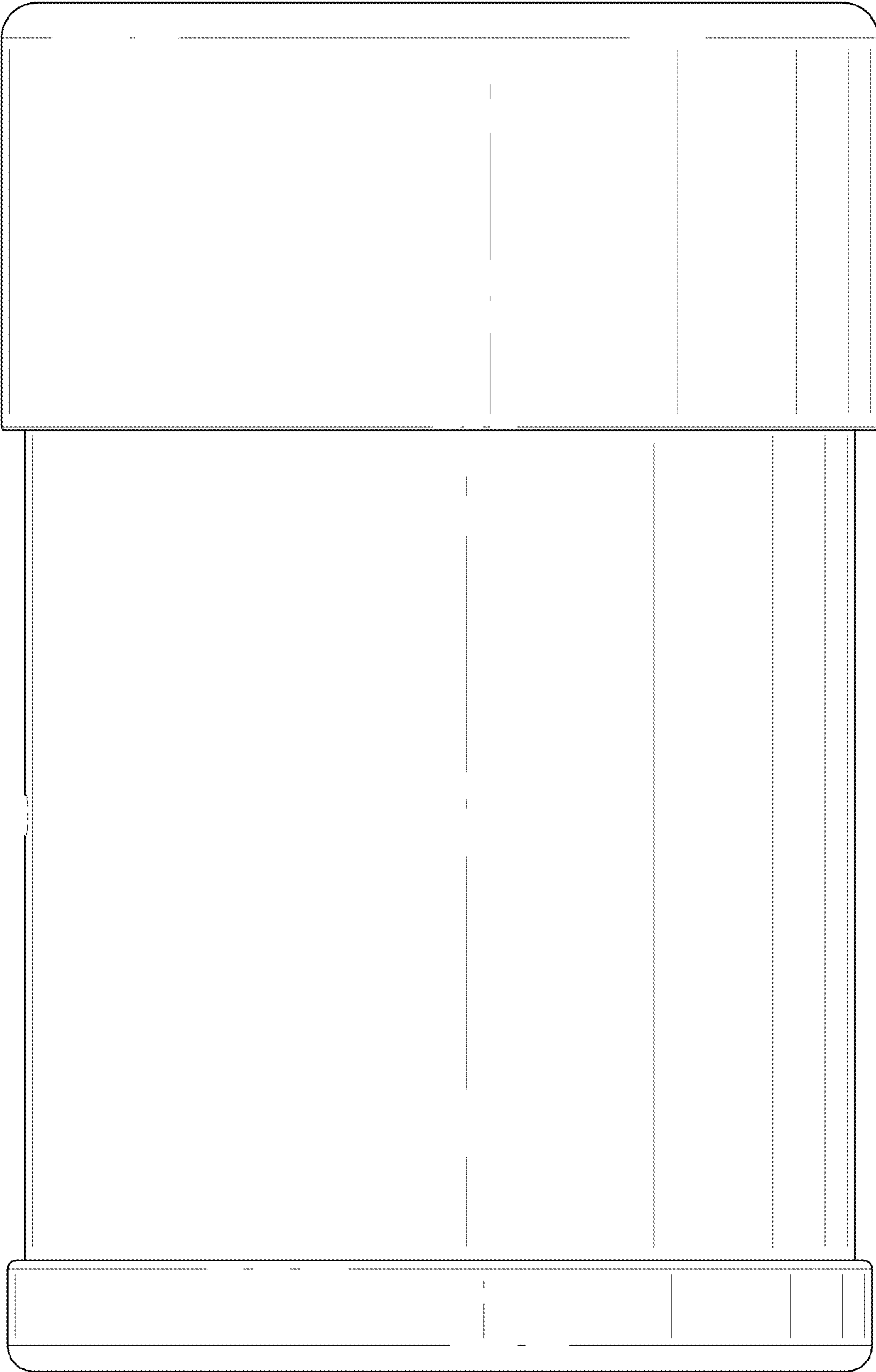

FIG. 7

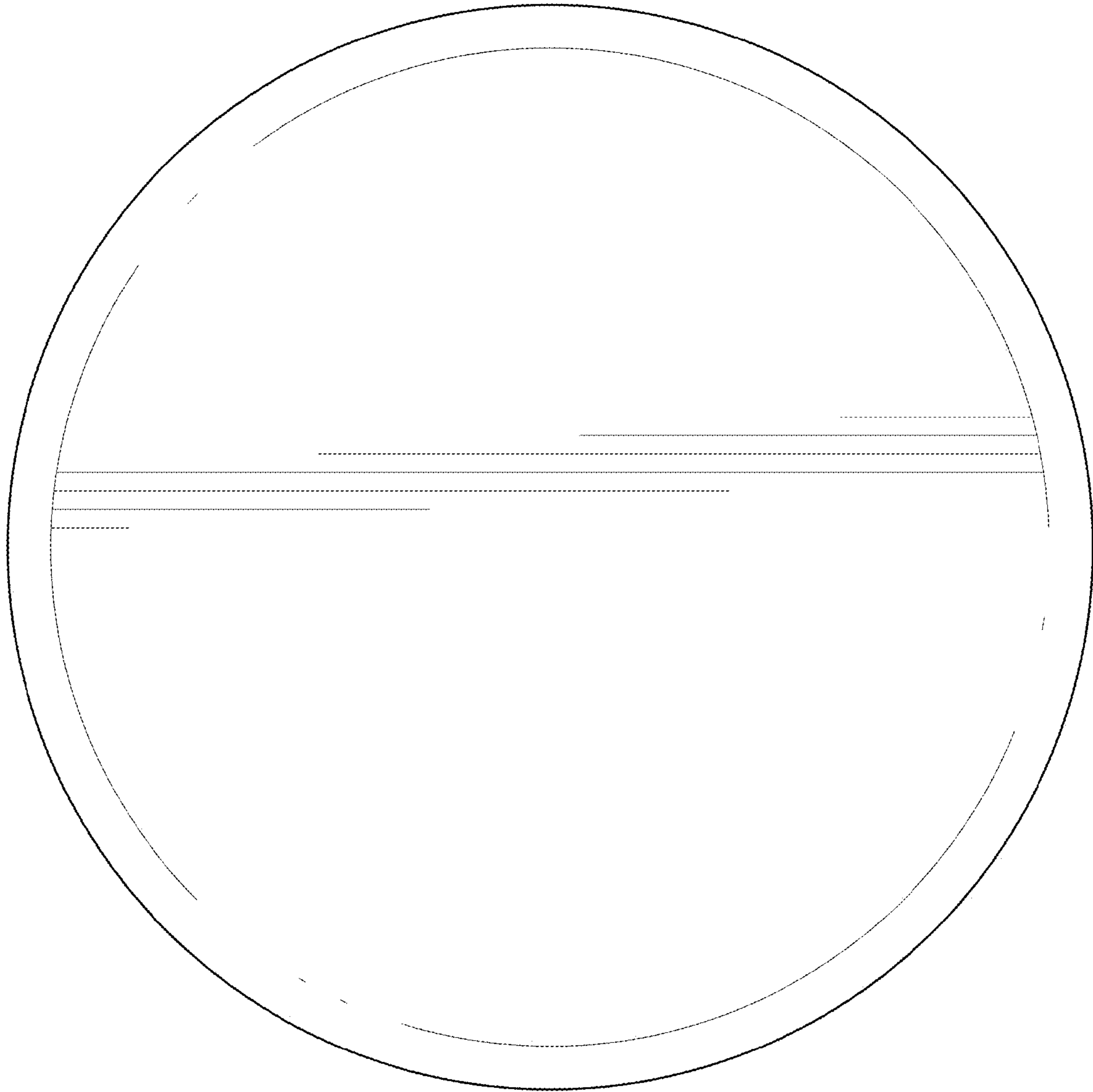

FIG. 8

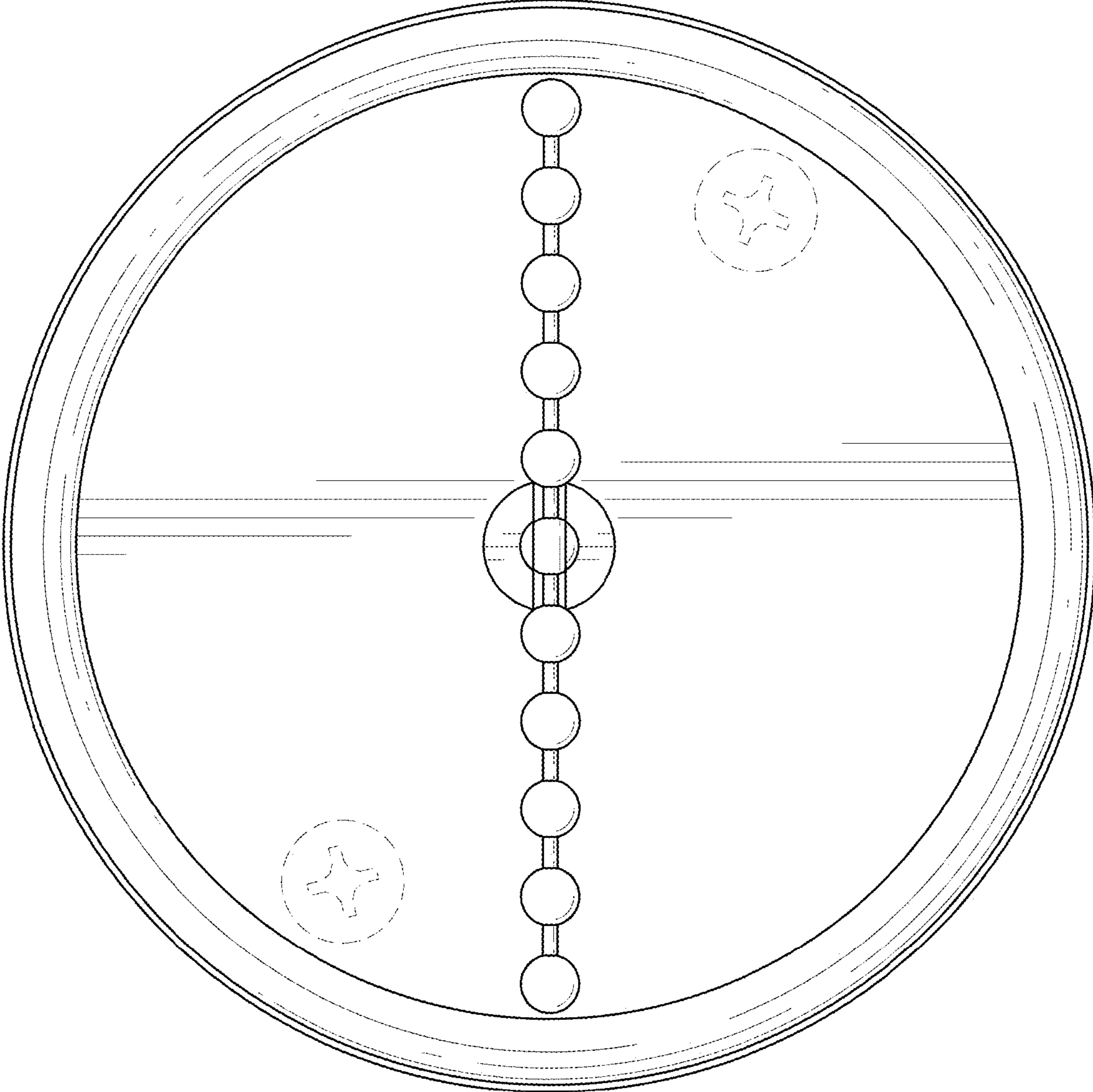

FIG. 9