



US00D918926S

(12) **United States Design Patent** (10) **Patent No.:** **US D918,926 S**
Vidyasgaran et al. (45) **Date of Patent:** **** May 11, 2021**

(54) **FOLDABLE DISPLAY POSITIONING ASSEMBLY**

(71) Applicant: **Tangible Play, Inc.**, Palo Alto, CA (US)

(72) Inventors: **Vivek Vidyasgaran**, Palo Alto, CA (US); **Jon Dukerschein**, Pacifica, CA (US); **Mark Solomon**, San Jose, CA (US); **Ariel Zekelman**, Palo Alto, CA (US)

(73) Assignee: **Tangible Play, Inc.**, Palo Alto, CA (US)

(**) Term: **15 Years**

(21) Appl. No.: **29/688,199**

(22) Filed: **Apr. 18, 2019**

(51) **LOC (13) Cl.** **08-07**

(52) **U.S. Cl.**
USPC **D14/447**

(58) **Field of Classification Search**
USPC D14/447, 432, 434, 439, 440, 451, 452, D14/457, 239, 253; D8/363, 373, 380; D6/406.3, 406.4, 406.5, 406.6; D12/415
(Continued)

(56) **References Cited**

U.S. PATENT DOCUMENTS

D287,365 S * 12/1986 Judd D14/447
D678,887 S * 3/2013 Stravitz D14/451
(Continued)

Primary Examiner — Angela J Lee

(74) *Attorney, Agent, or Firm* — VLP Law Group LLP; Michel Bohn

(57) **CLAIM**

The ornamental design for a foldable display positioning assembly, as shown and described.

DESCRIPTION

FIG. 1 is a front, left perspective view of a foldable display positioning assembly.

FIG. 2 is a bottom, rear perspective view thereof.
FIG. 3 is a top view thereof.
FIG. 4 is a bottom view thereof.
FIG. 5 is a left side view thereof showing the assembly in use with broken line environment (a right side view being a mirror image of the left side view).
FIG. 6 is a right side view thereof without broken line environment (a left side view being a mirror image of the right side view).
FIG. 7 is a front view thereof.
FIG. 8 is a rear view thereof showing the assembly in use with broken line environment.
FIG. 9 is a front, left perspective view thereof.
FIG. 10 is a front, left perspective view of a portion of the foldable display positioning assembly shown separately for clarity of illustration.
FIG. 11 is a bottom, rear perspective view thereof.
FIG. 12 is a top view thereof.
FIG. 13 is a bottom view thereof.
FIG. 14 is a left side view thereof.
FIG. 15 is a right side view thereof.
FIG. 16 is a front view thereof.
FIG. 17 is a rear view thereof.
FIG. 18 is a front, left perspective view of a different portion of the foldable display positioning assembly shown separately for clarity of illustration.
FIG. 19 is a bottom, rear perspective view thereof.
FIG. 20 is a top view thereof.
FIG. 21 is a bottom view thereof.
FIG. 22 is a left side view thereof (a right side view being a mirror image of the left side view).
FIG. 23 is a front view thereof.
FIG. 24 is a rear view thereof.
FIG. 25 is a top perspective view of a different and unfolded portion of the foldable display positioning assembly shown separately for clarity of illustration.
FIG. 26 is a bottom perspective view thereof.
FIG. 27 is a top view thereof (a bottom view being a mirror image of the top view).
FIG. 28 is a left side view thereof.
FIG. 29 is a right side view thereof.
FIG. 30 is a front view thereof.
FIG. 31 is a rear view thereof.

(Continued)

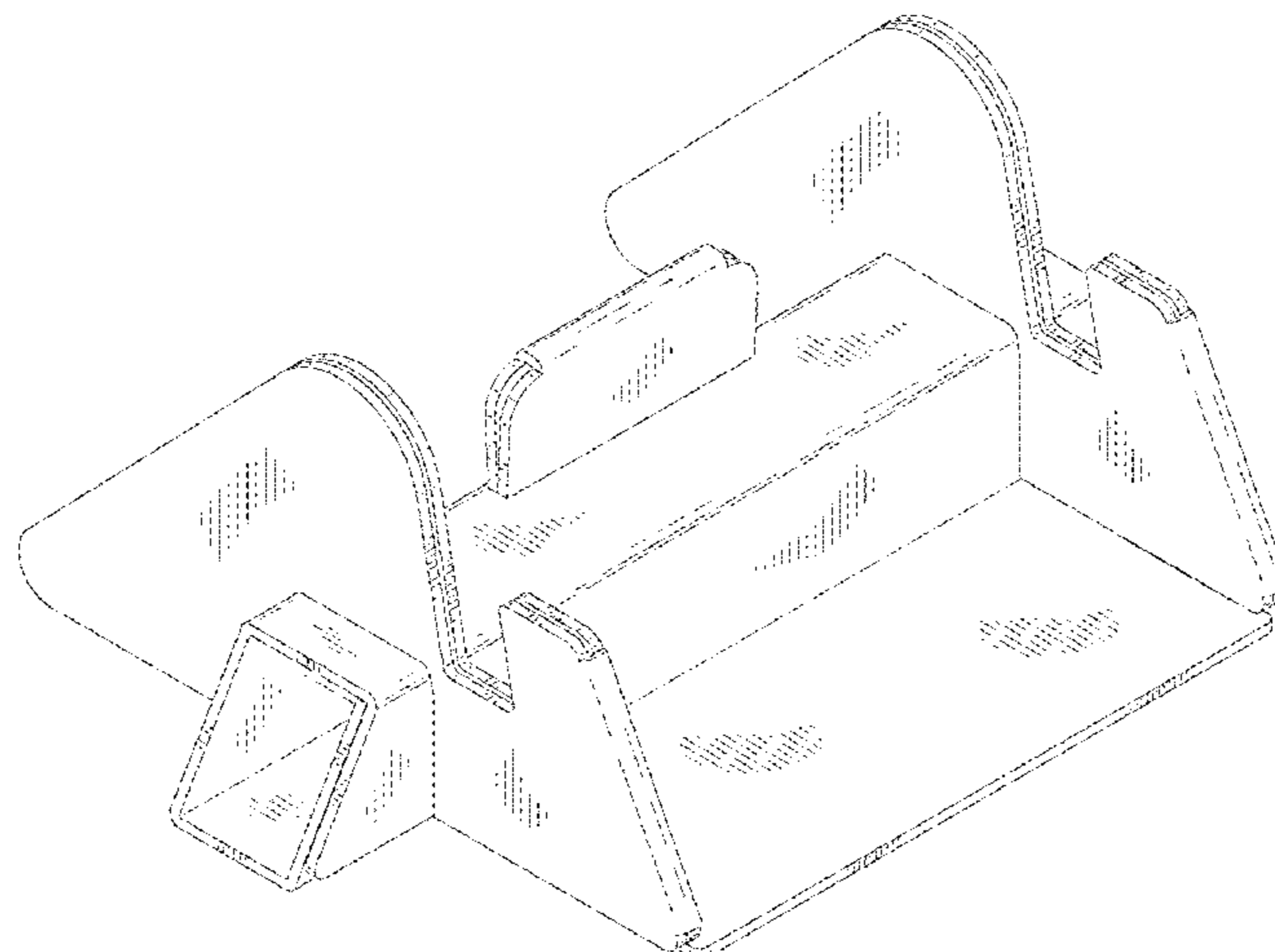

FIG. 32 is a top perspective view of a different and unfolded portion of the foldable display positioning assembly shown separately for clarity of illustration.

FIG. 33 is a bottom perspective view thereof.

FIG. 34 is a top view thereof (a bottom view being a mirror image of the top view).

FIG. 35 is a left side view thereof.

FIG. 36 is a right side view thereof.

FIG. 37 is a front view thereof.

FIG. 38 is a rear view thereof.

FIG. 39 is a top perspective view of a different and unfolded portion of the foldable display positioning assembly shown separately for clarity of illustration.

FIG. 40 is a bottom perspective view thereof.

FIG. 41 is a top view thereof (a bottom view being a mirror image of the top view).

FIG. 42 is a left side view thereof.

FIG. 43 is a right side view thereof.

FIG. 44 is a front view thereof; and,

FIG. 45 is a rear view thereof.

Within the drawings, the broken lines are to show environment of the foldable display positioning assembly in use, and form no part of the claimed design.

1 Claim, 37 Drawing Sheets

(58) **Field of Classification Search**

CPC A47B 21/04; A47B 2097/006; A47B
2097/005; A47B 2023/049; A45C
2011/002; A45C 2011/003; F16M
2200/00; F16M 13/00

See application file for complete search history.

(56) **References Cited**

U.S. PATENT DOCUMENTS

D696,260	S	*	12/2013	Merea	D14/447
D714,297	S	*	9/2014	Poulsen	D14/447
D755,796	S	*	5/2016	Gibson	D14/447
D771,055	S	*	11/2016	Sharma	D14/447
D840,408	S	*	2/2019	Chen	D14/447
D842,862	S	*	3/2019	Ellis	D14/447
D867,370	S	*	11/2019	Taylor	A47B 21/04 D14/447
D868,792	S	*	12/2019	Zeng	D14/447
D869,472	S	*	12/2019	Wong	D14/447
2018/0136695	A1	*	5/2018	Lo	H04R 1/02

* cited by examiner

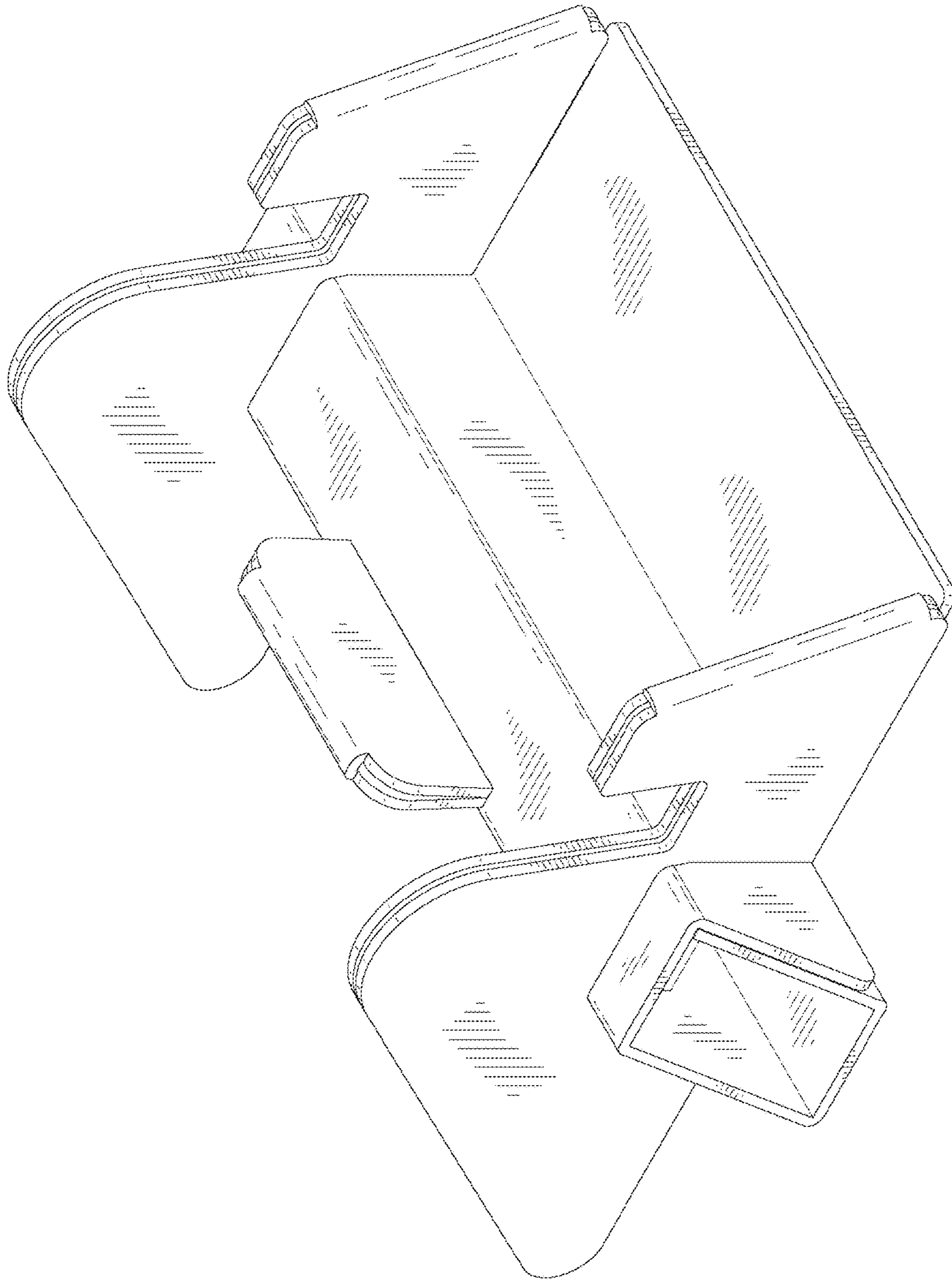

FIG. 1

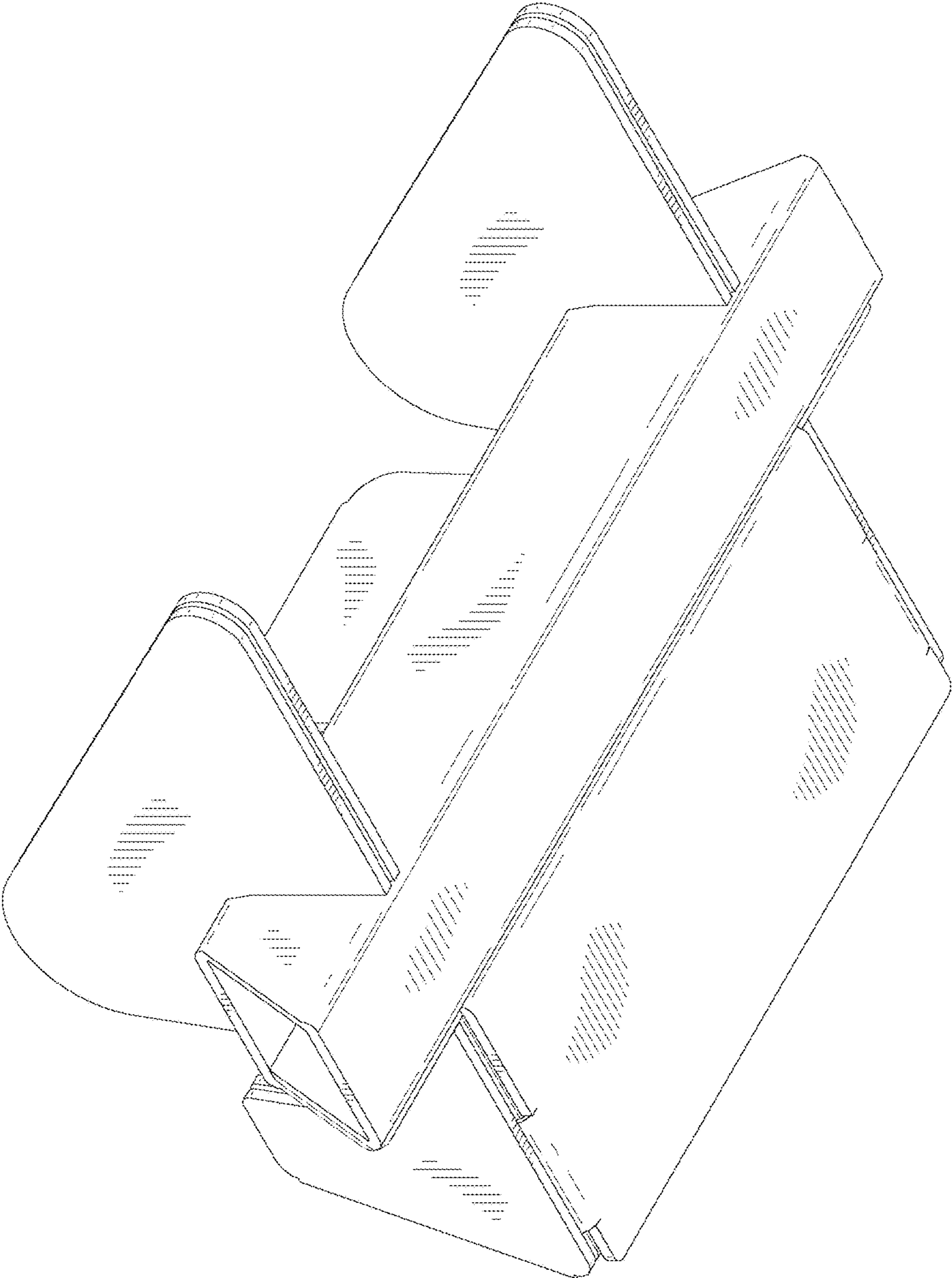

FIG. 2

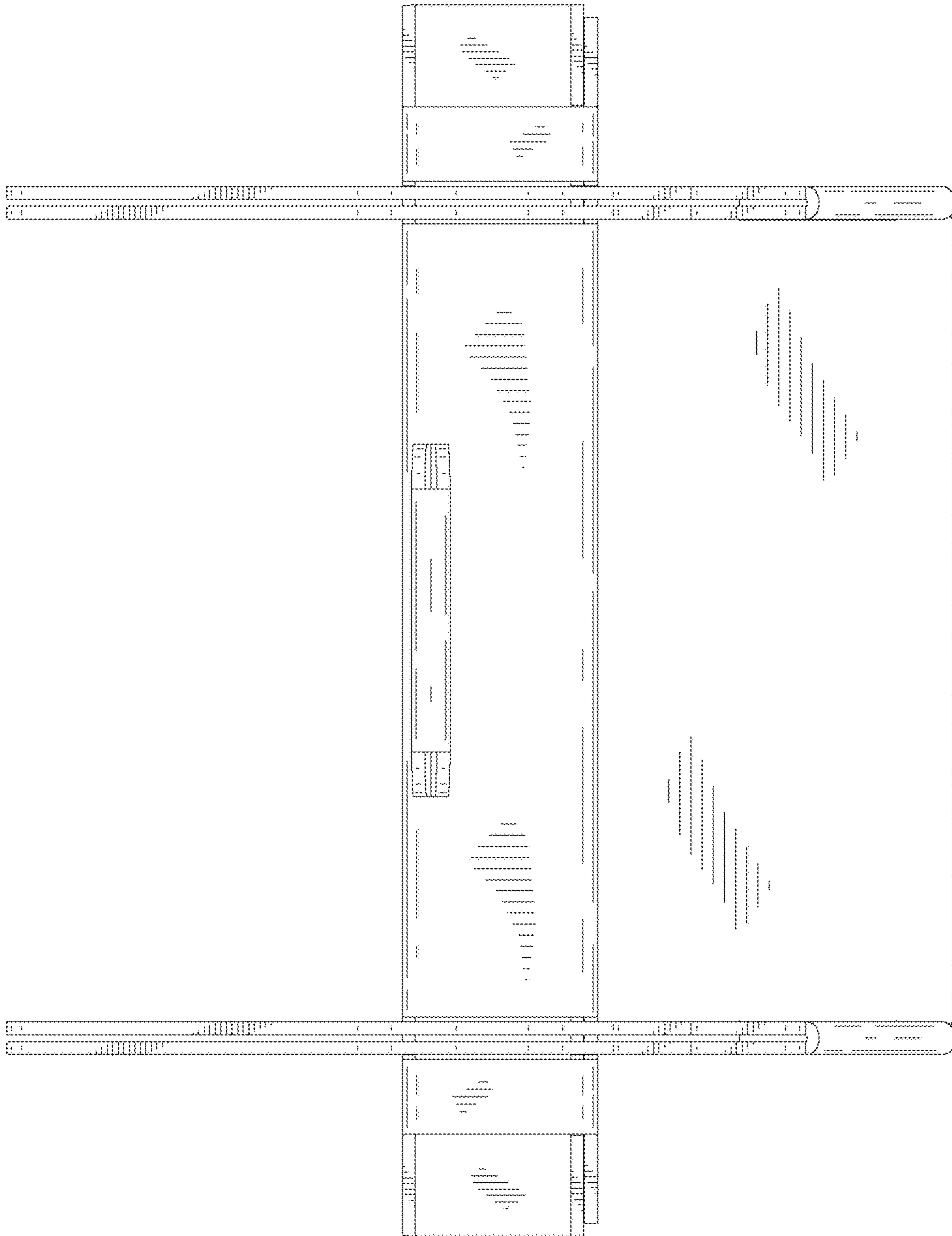

FIG. 3

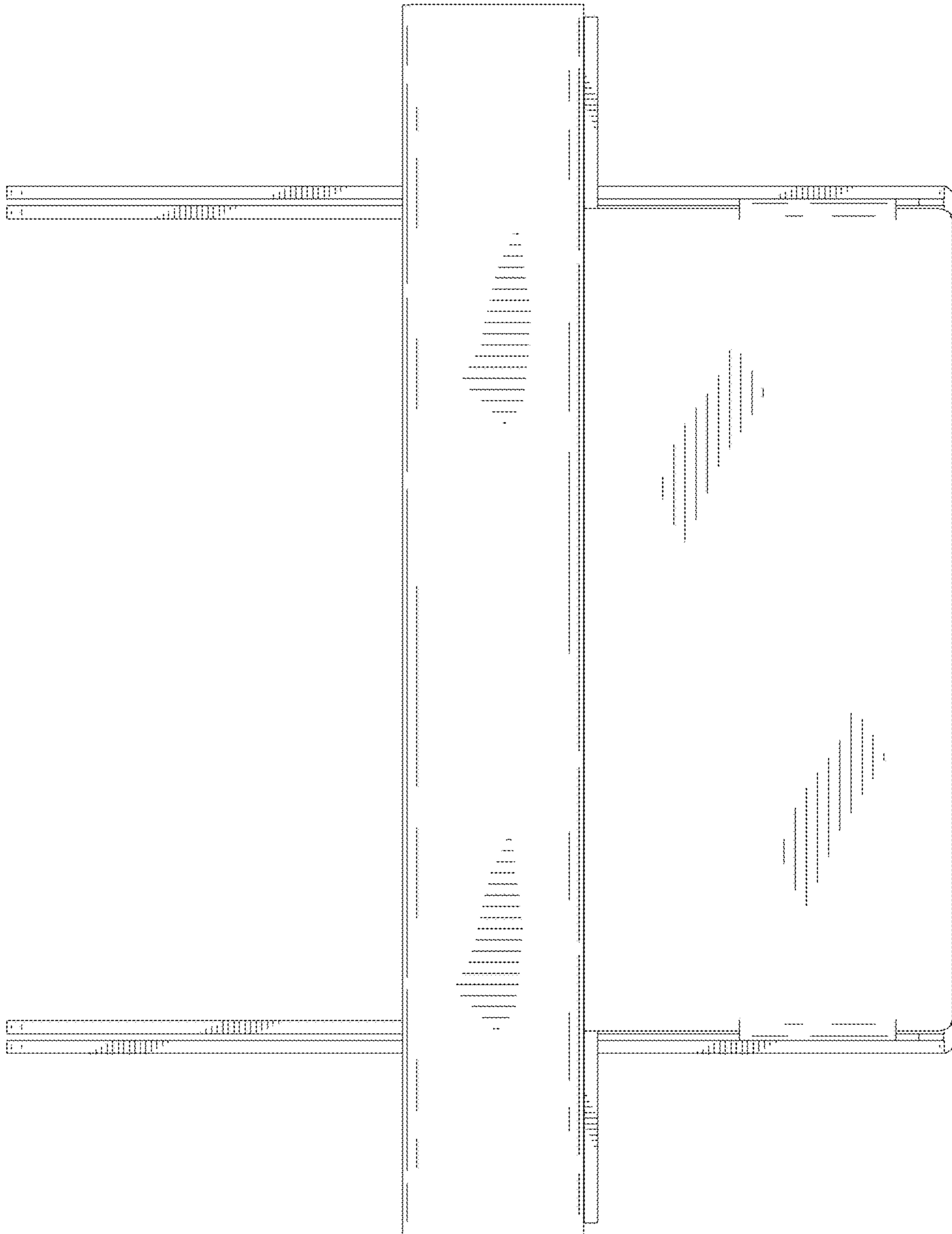

FIG. 4

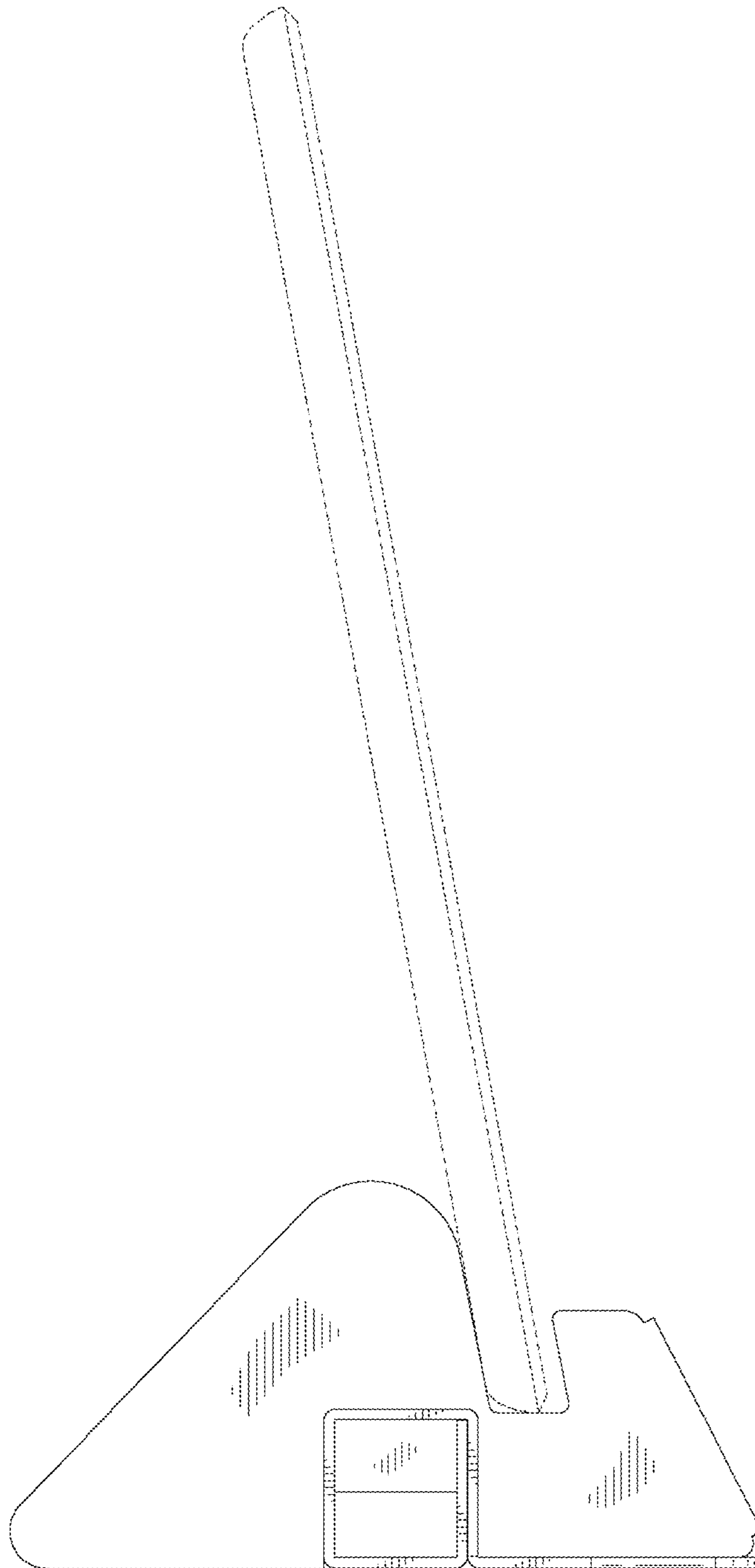

FIG. 5

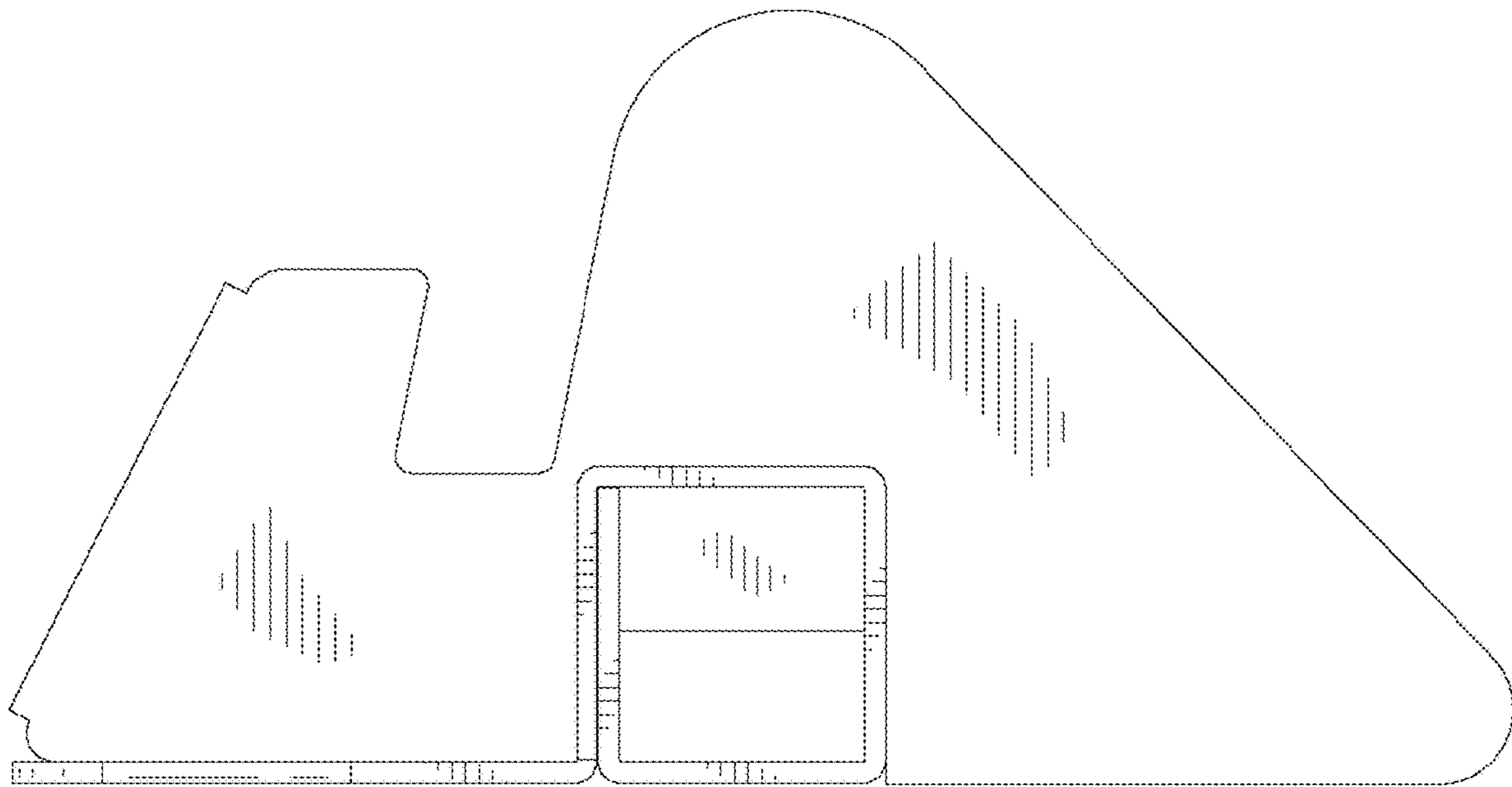

FIG. 6

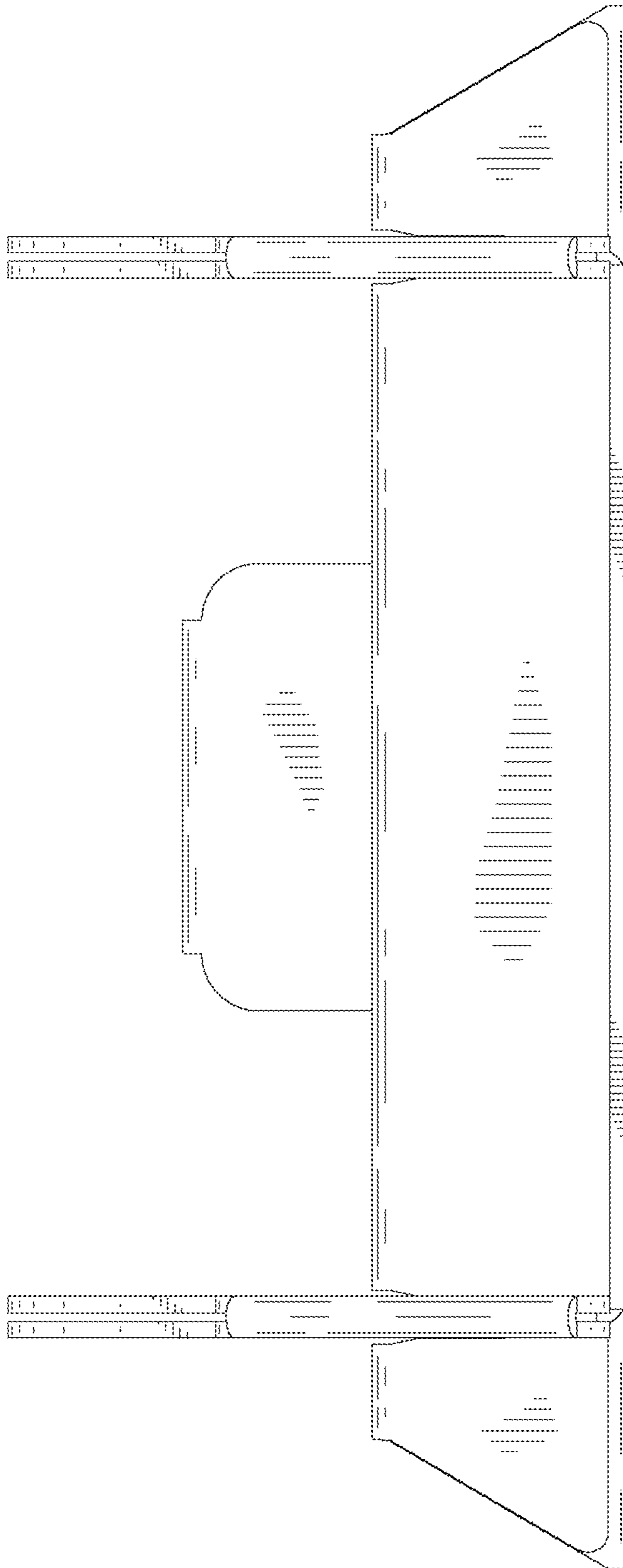

FIG. 7

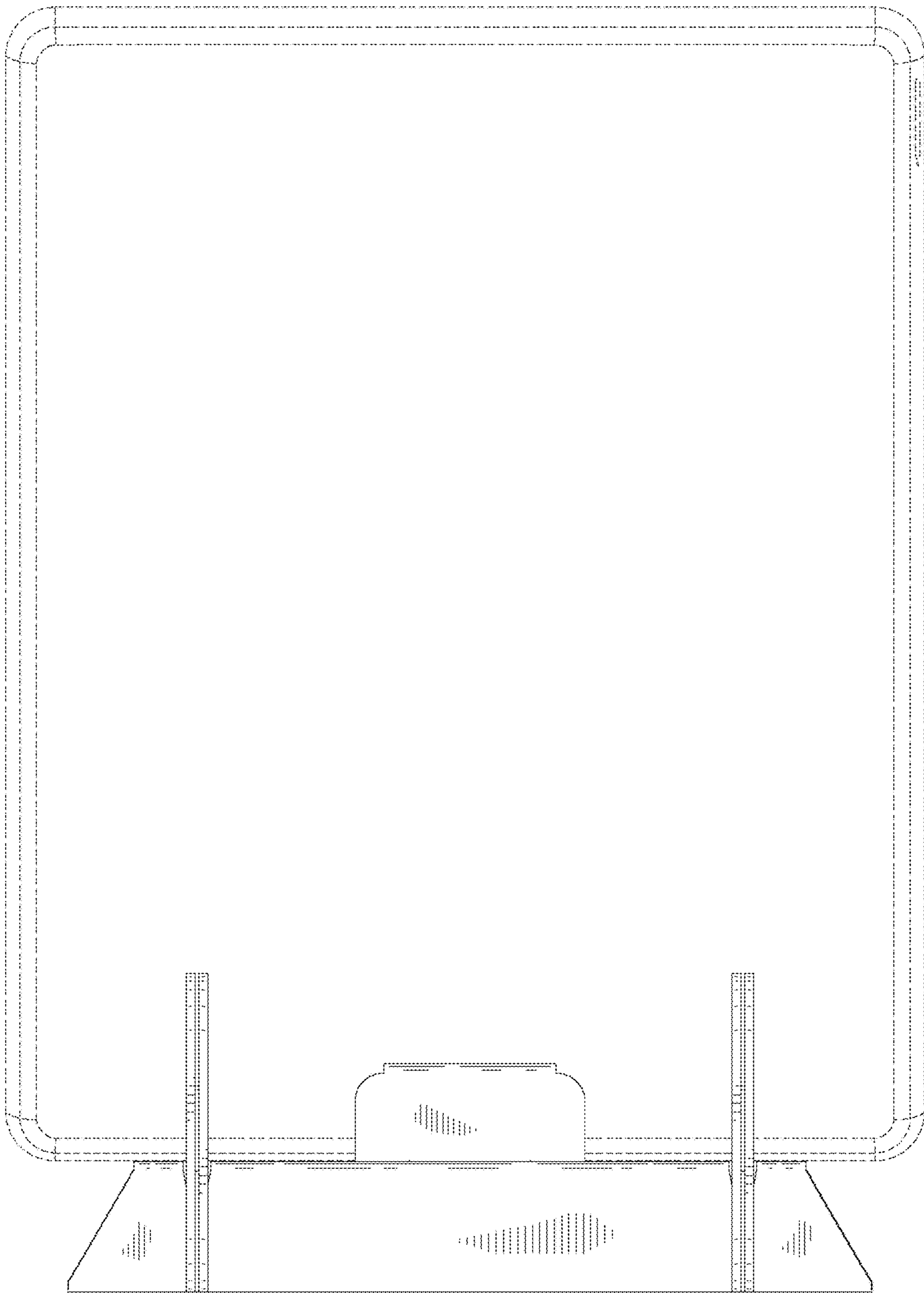

FIG. 8

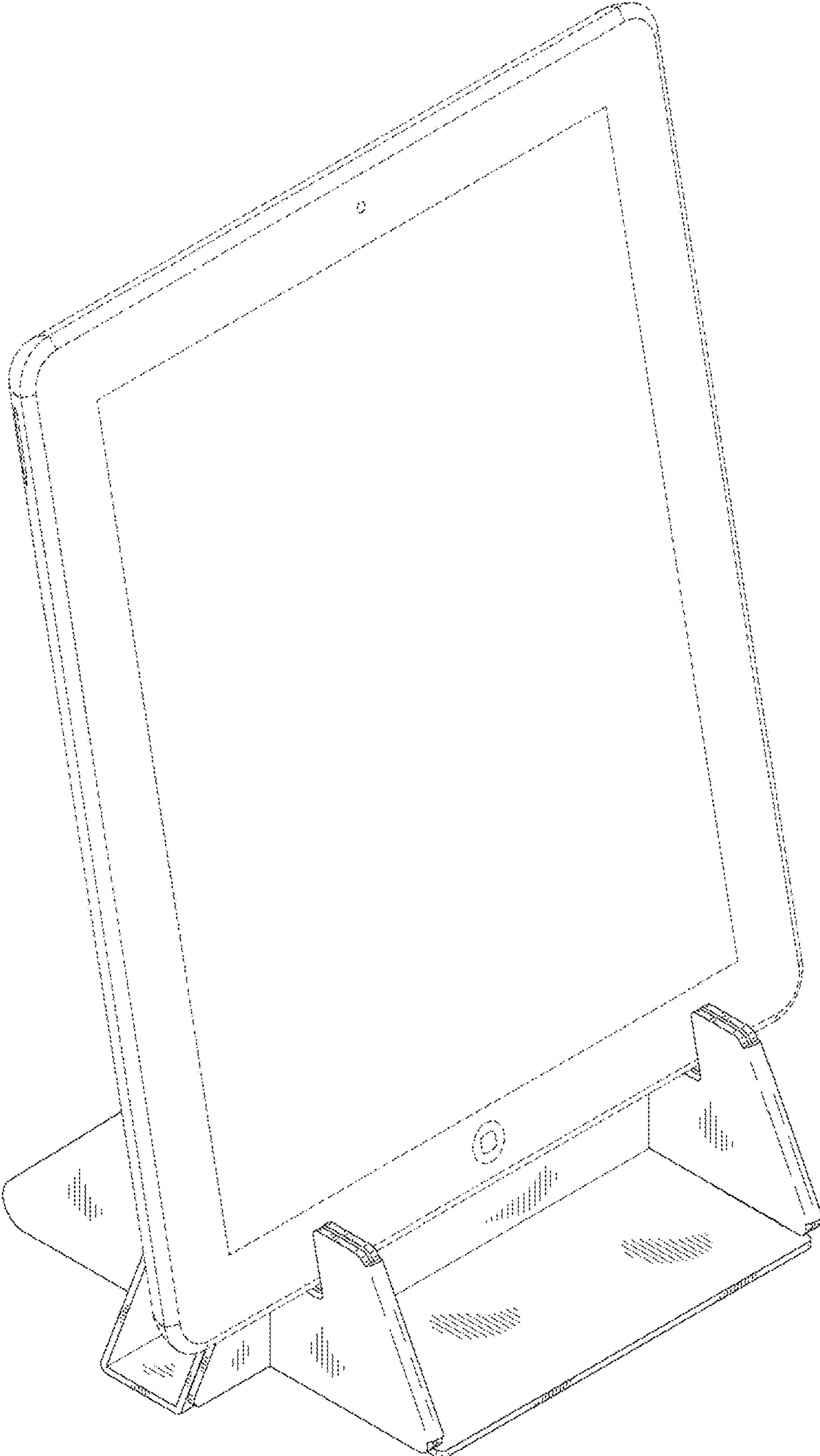

FIG. 9

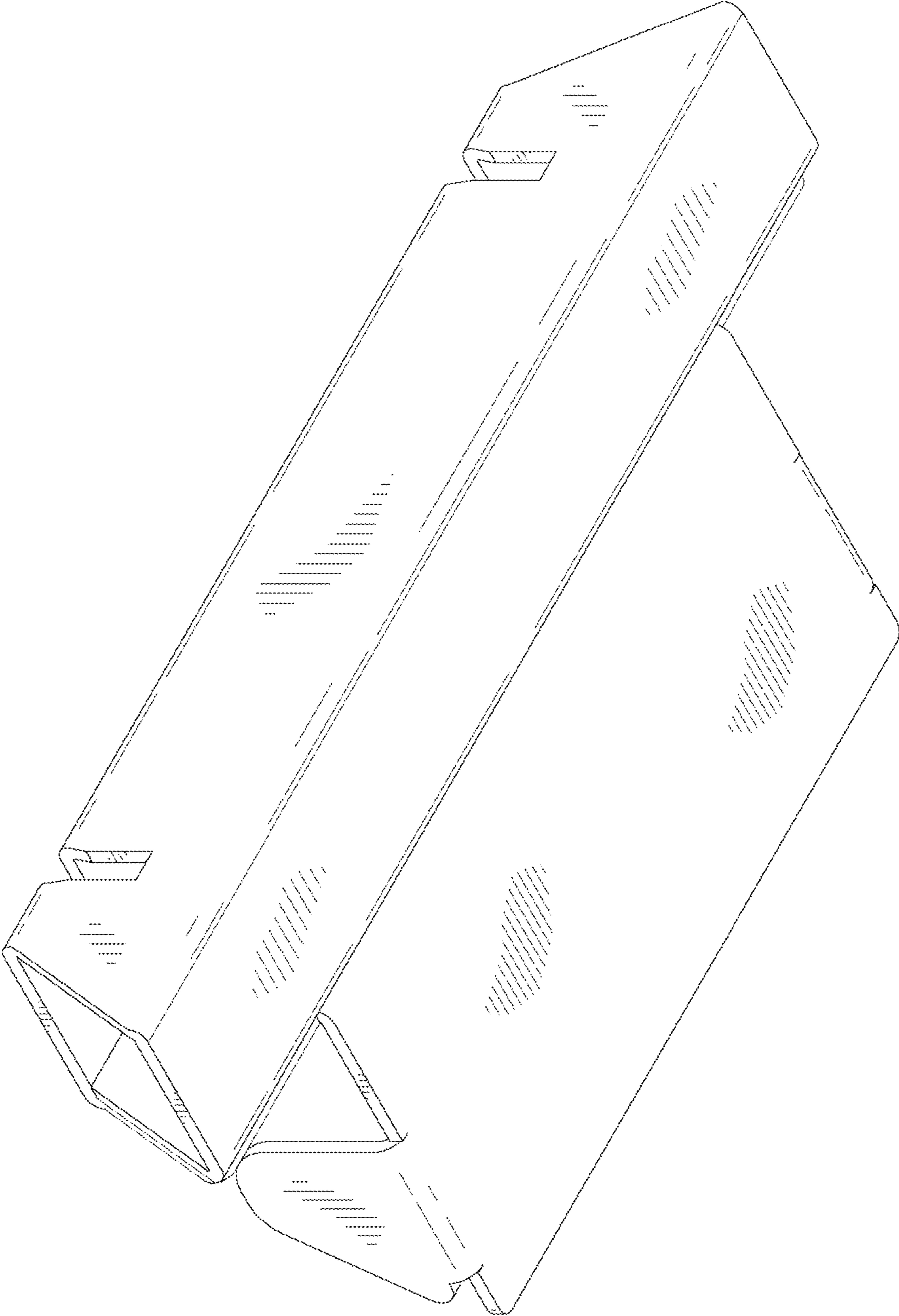

FIG. 11

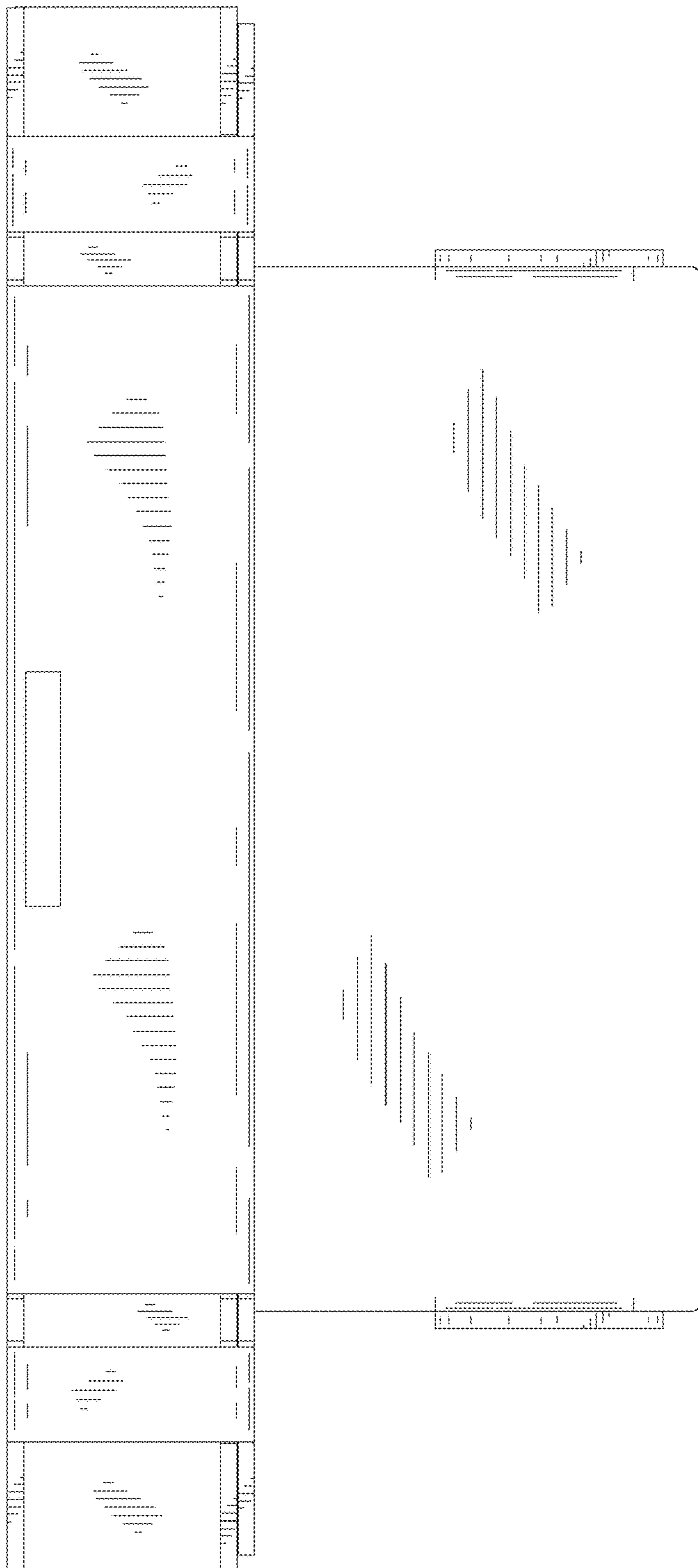

FIG. 12

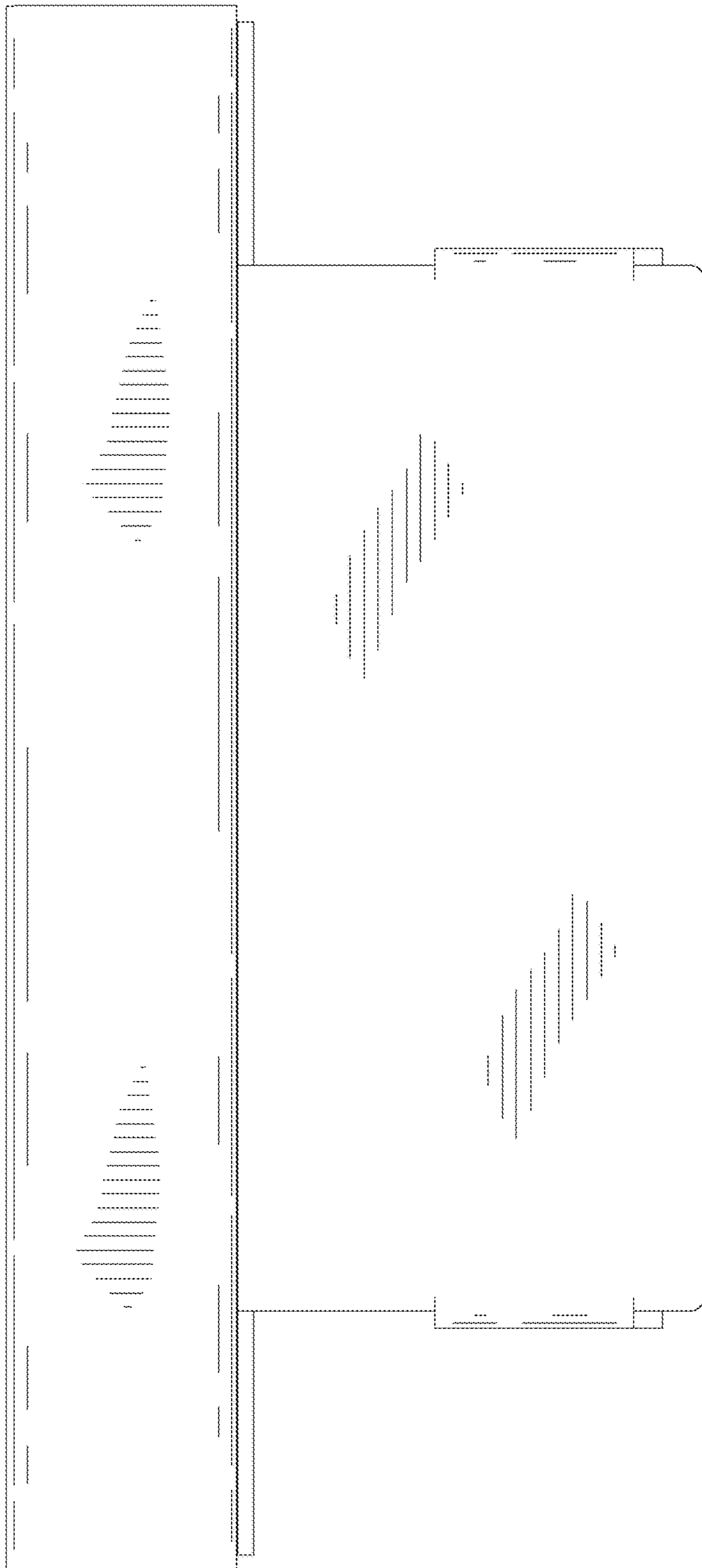

FIG. 13

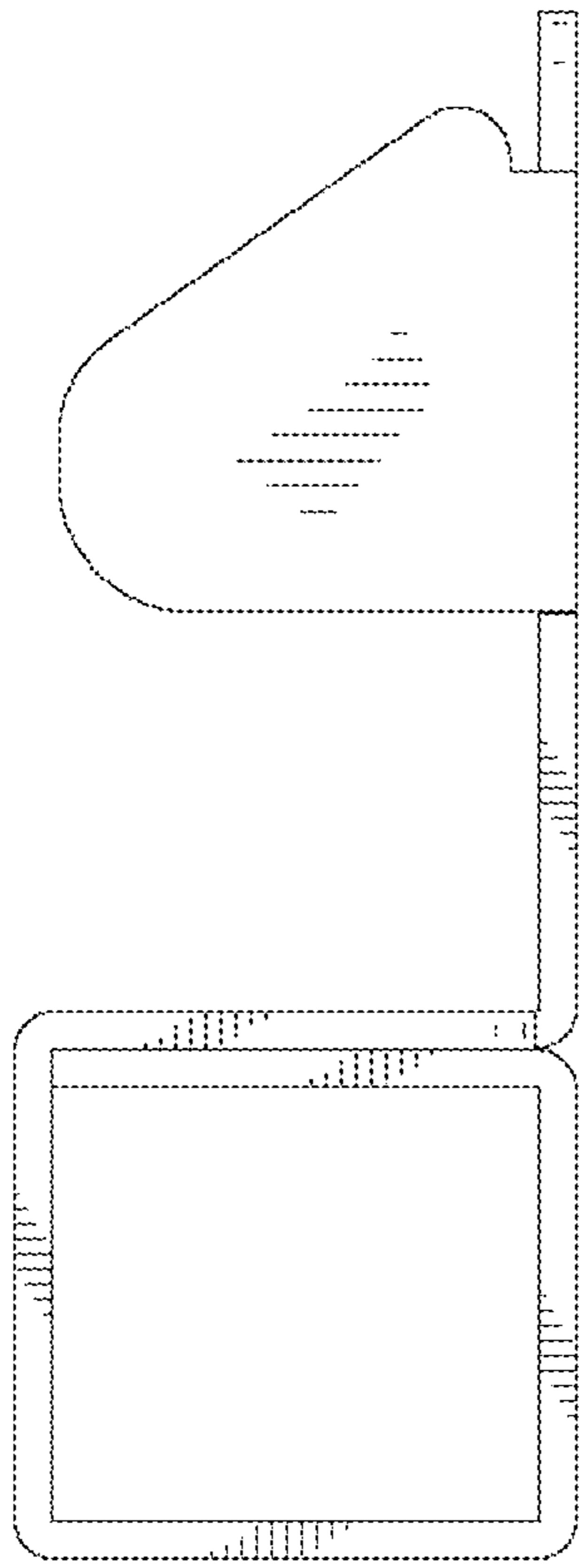

FIG. 14

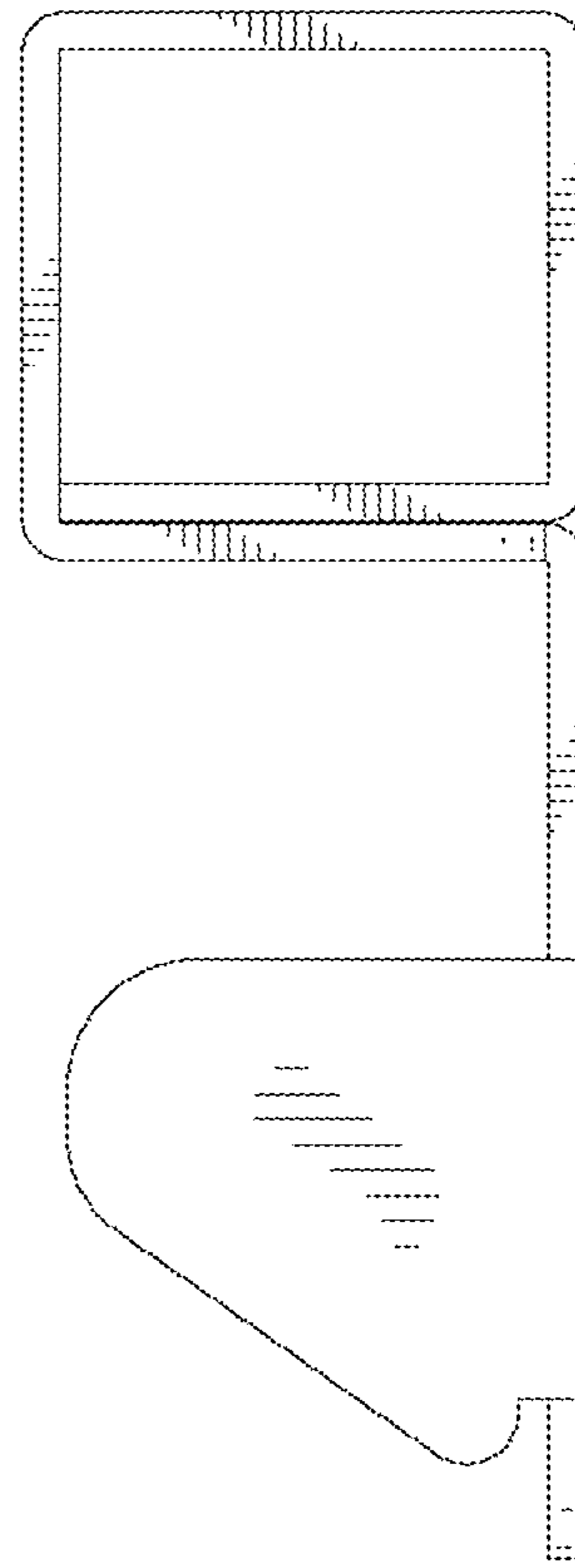

FIG. 15

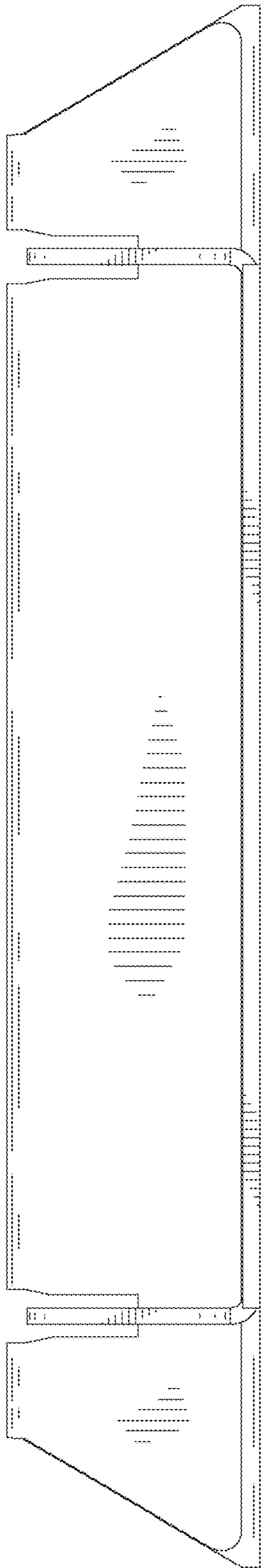

FIG. 16

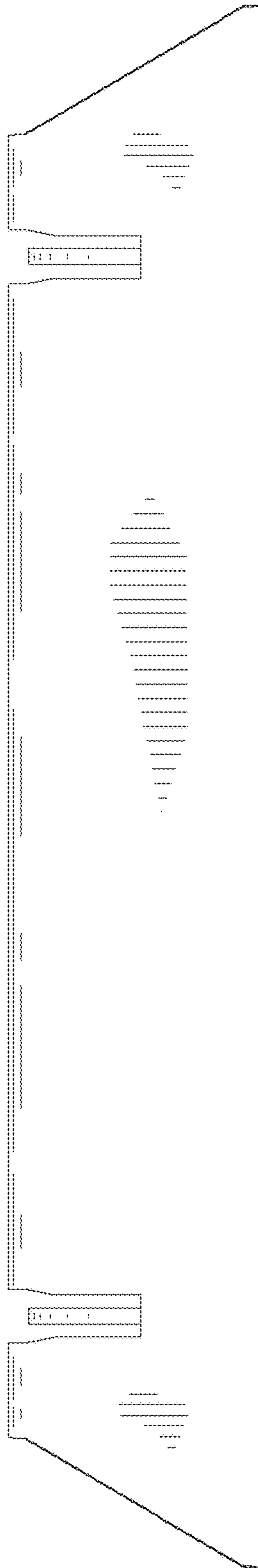

FIG. 17

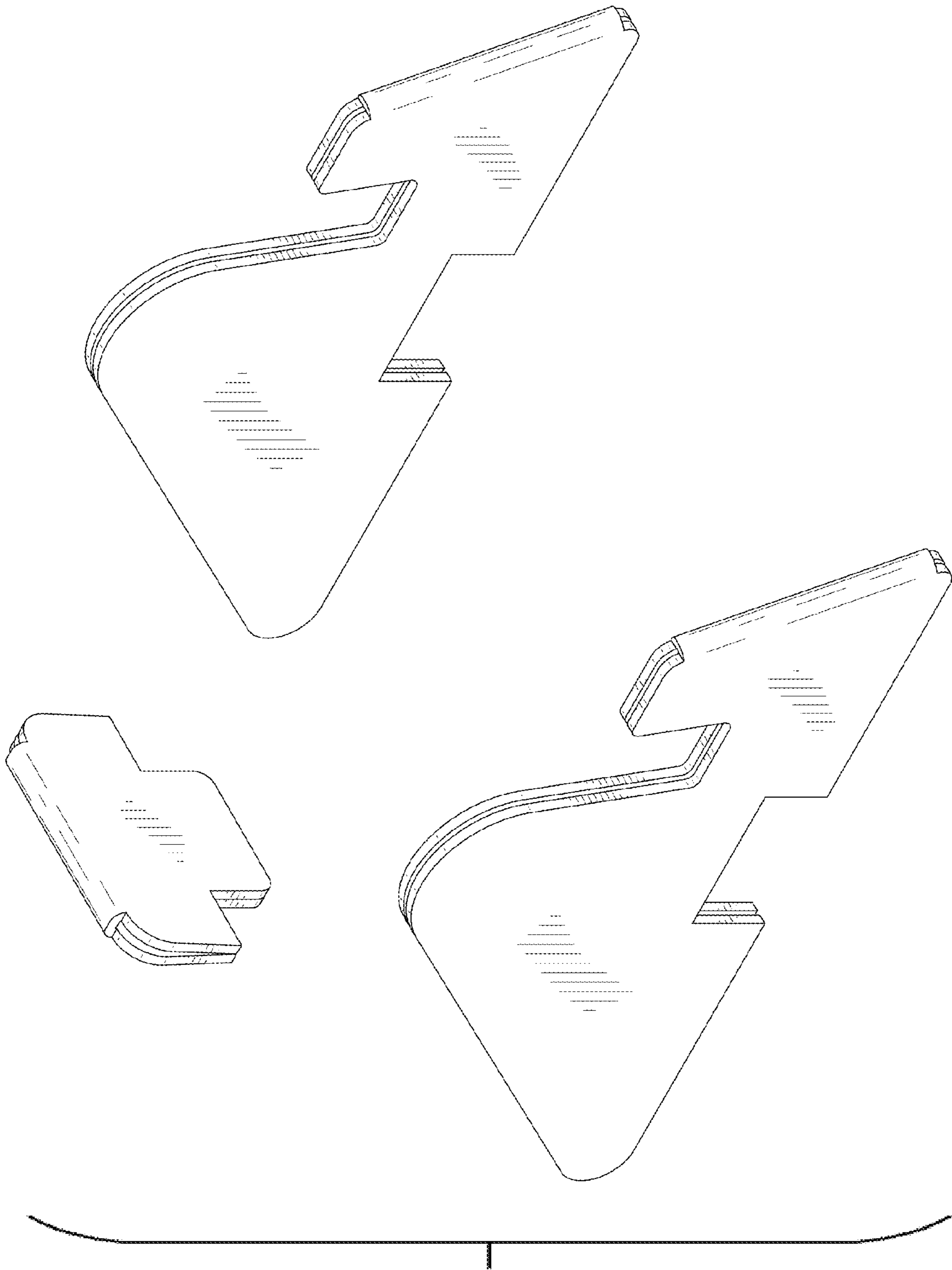

FIG. 18

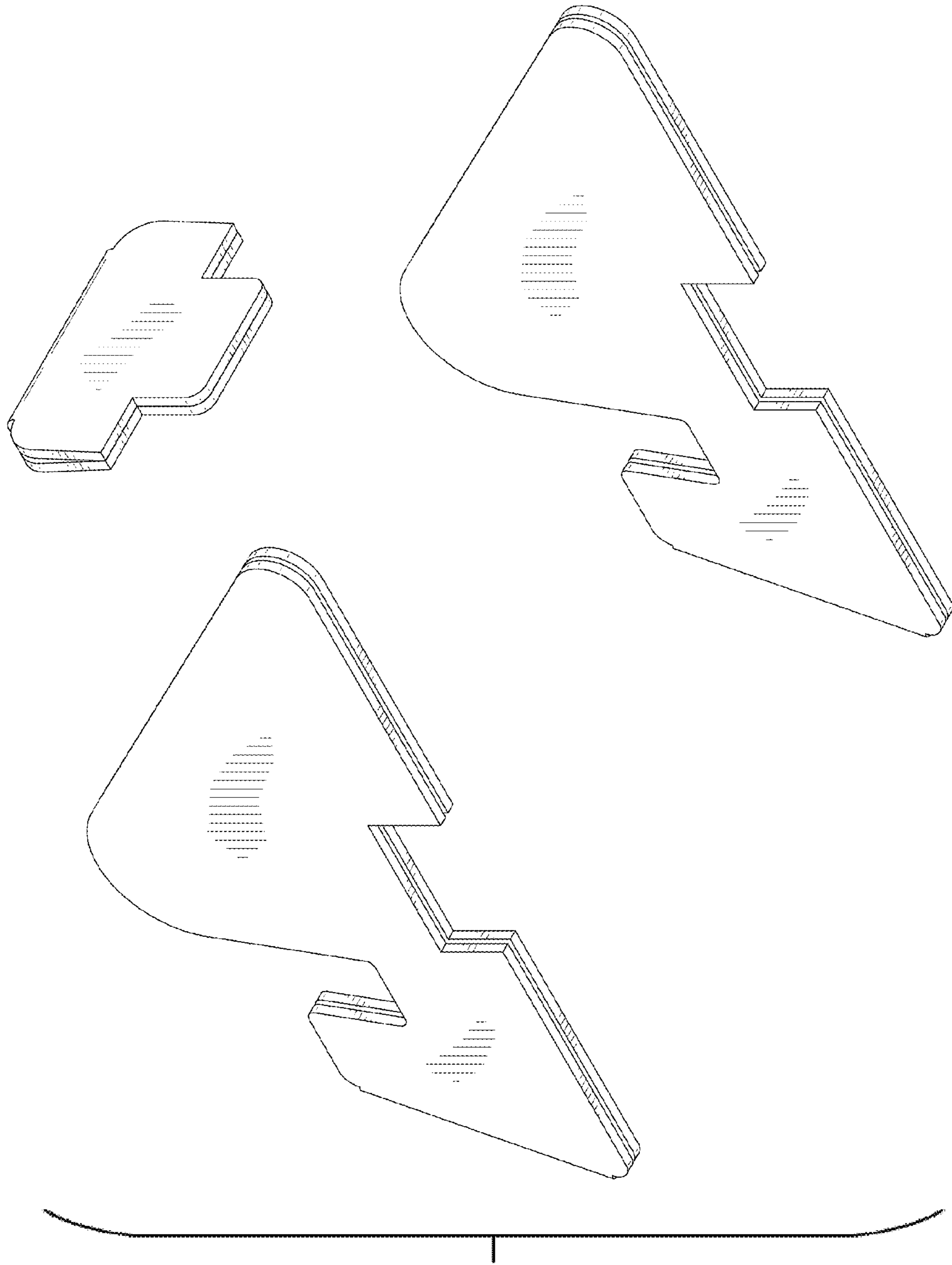

FIG. 19

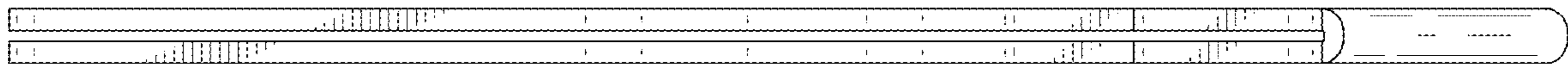
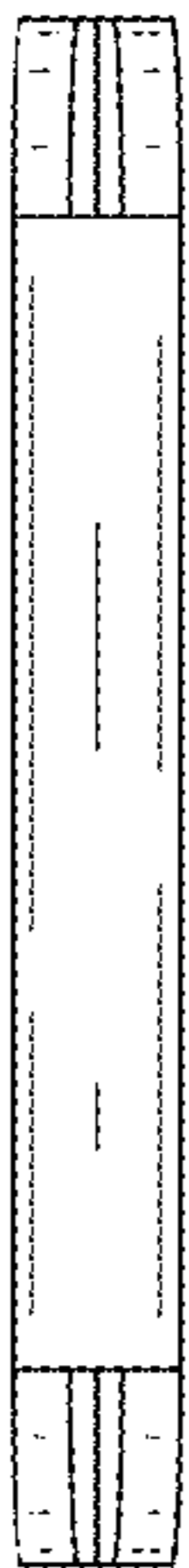
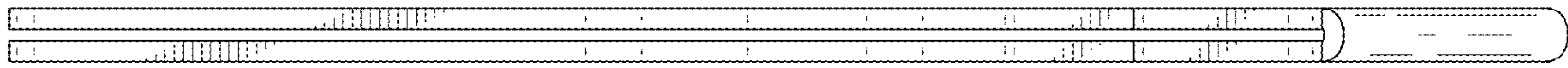

FIG. 20

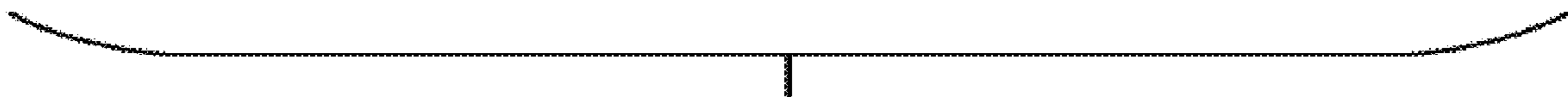
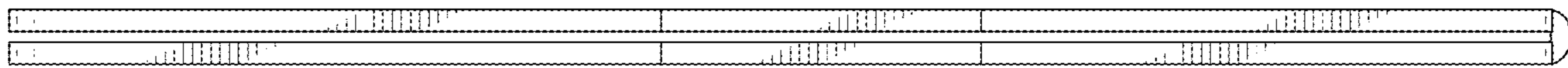
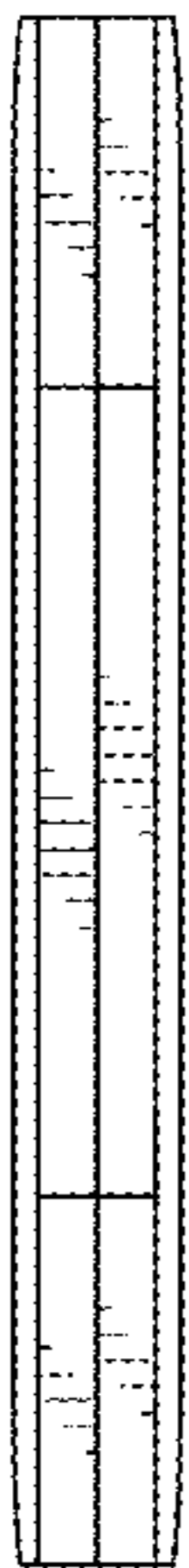
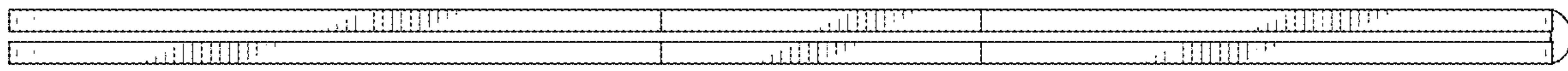

FIG. 21

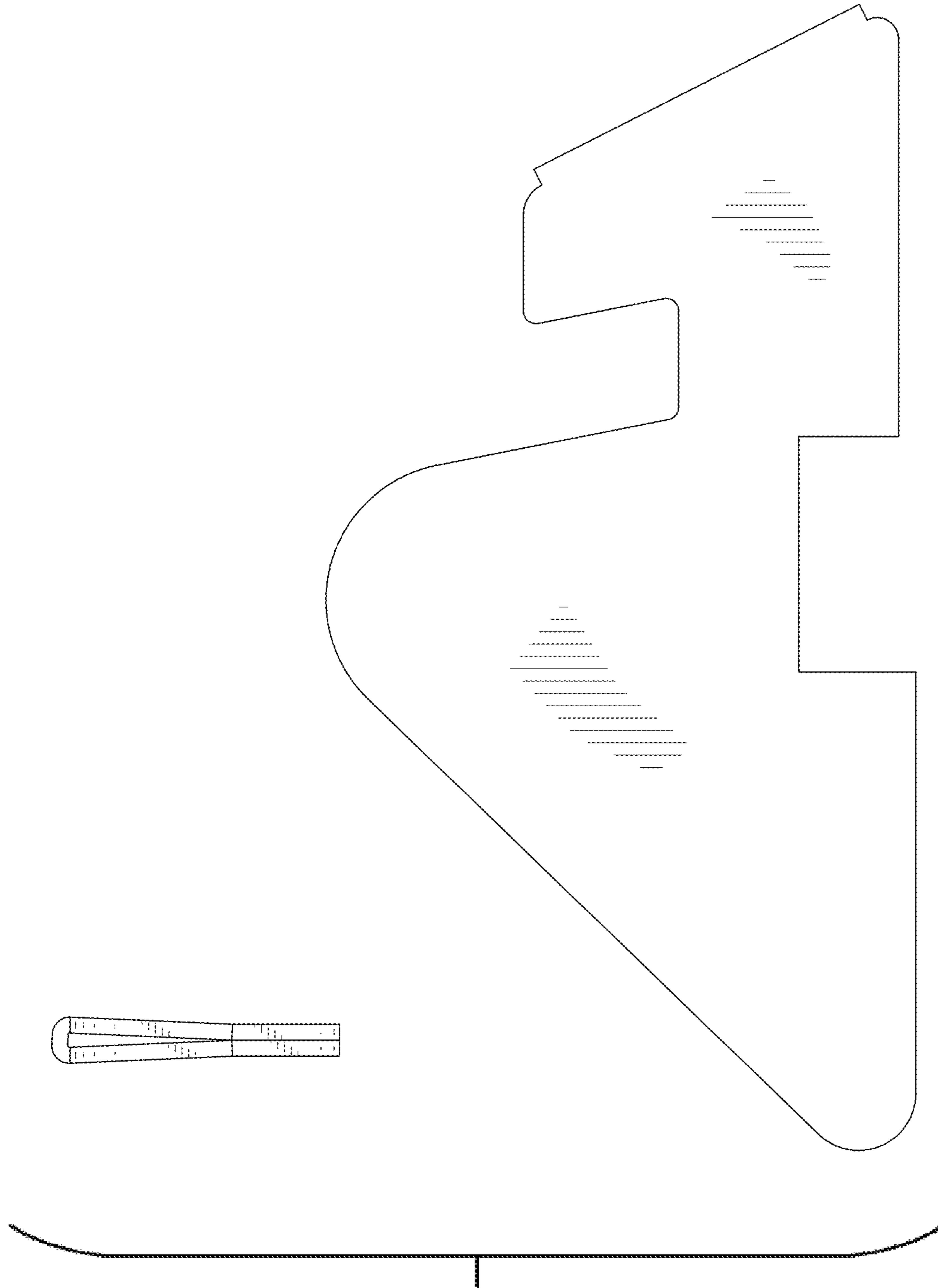

FIG. 22

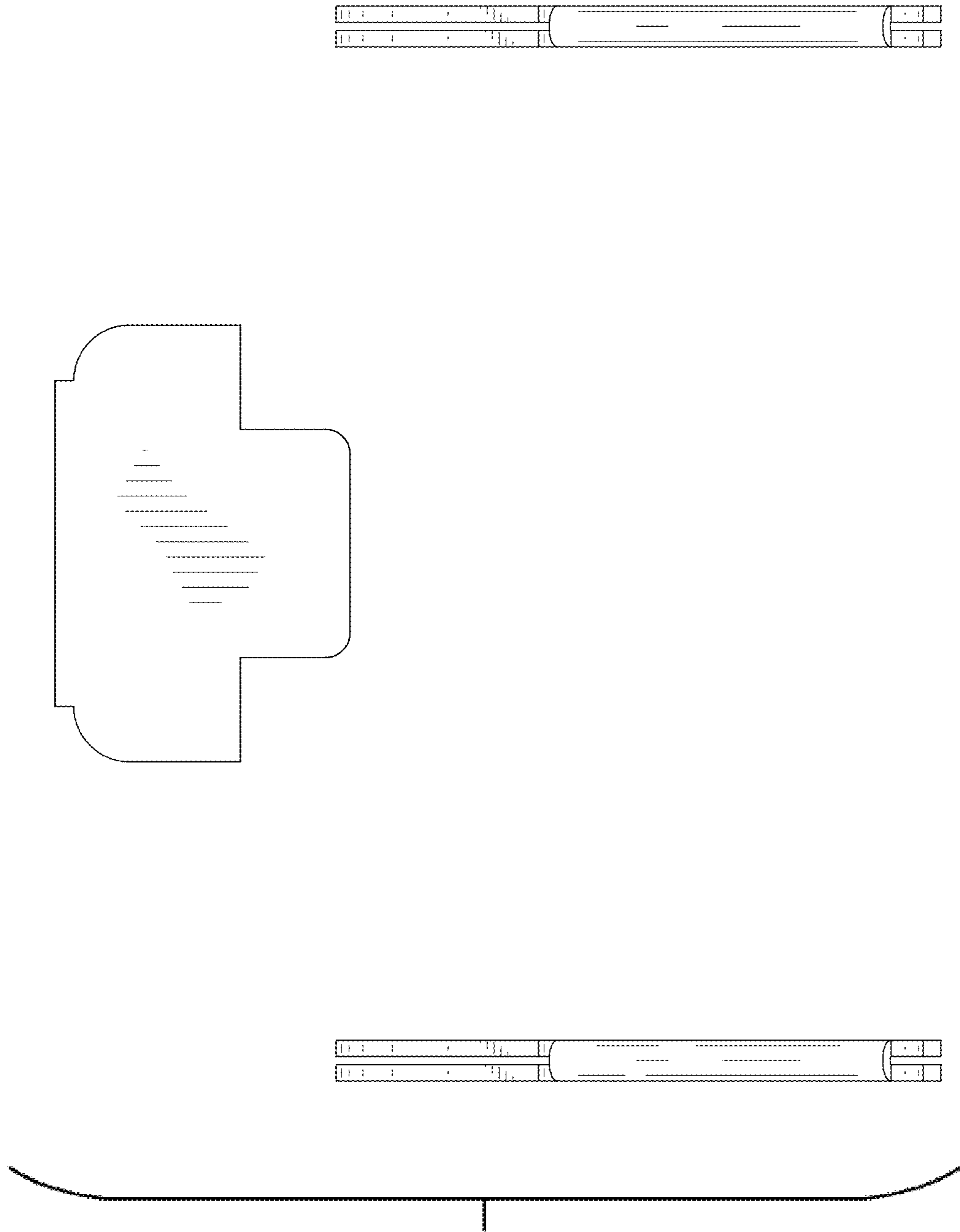

FIG. 23

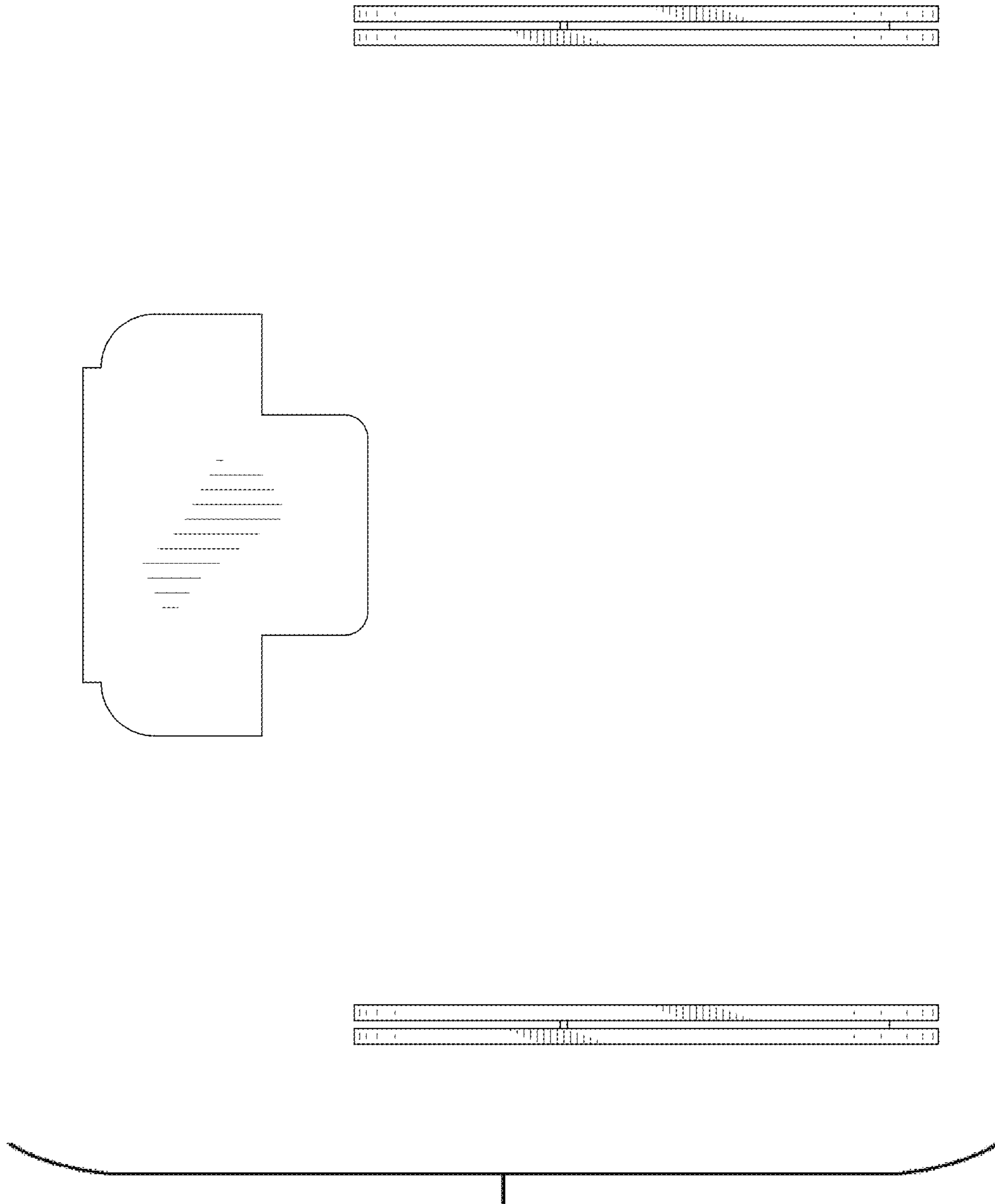

FIG. 24

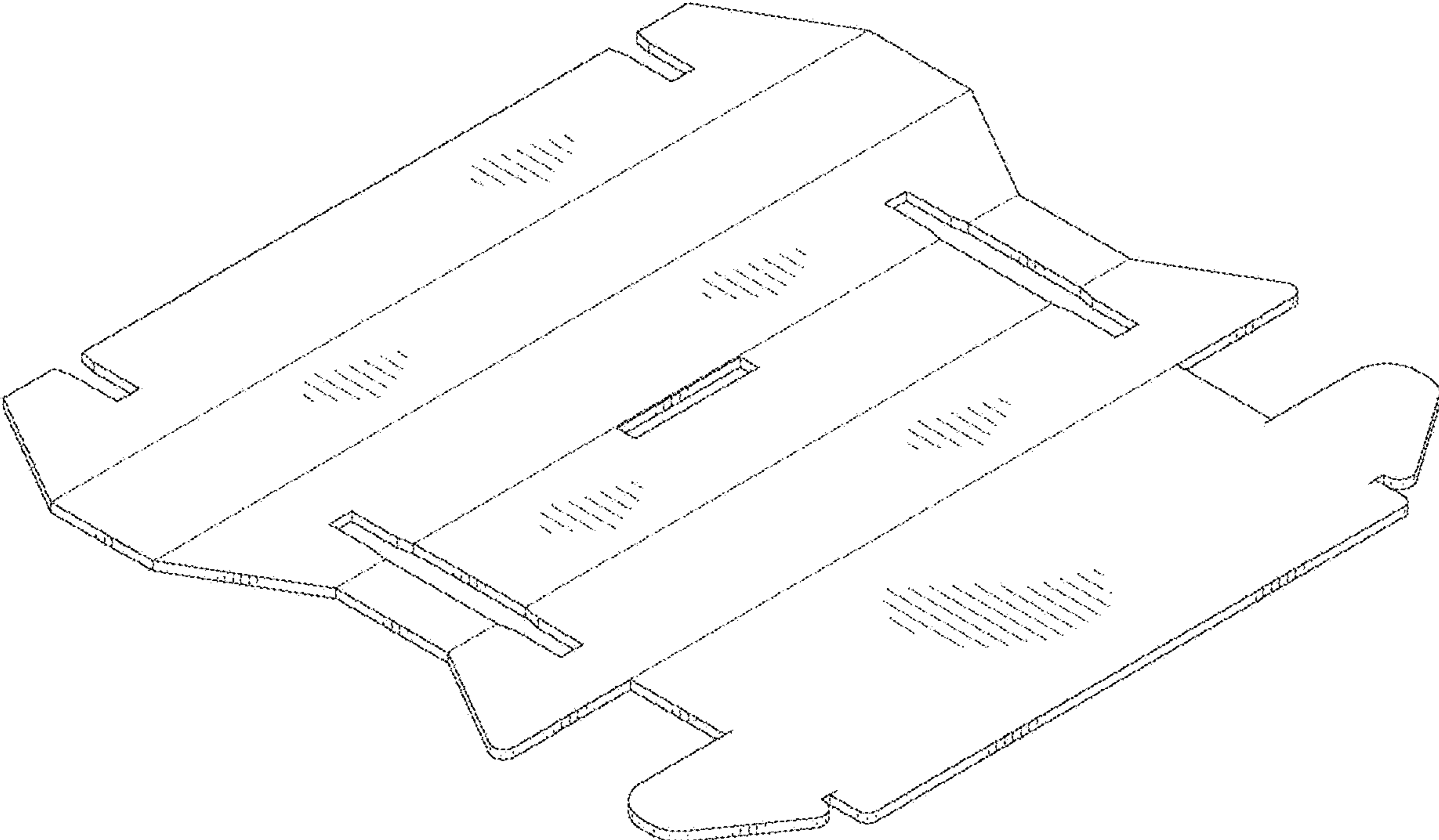

FIG. 25

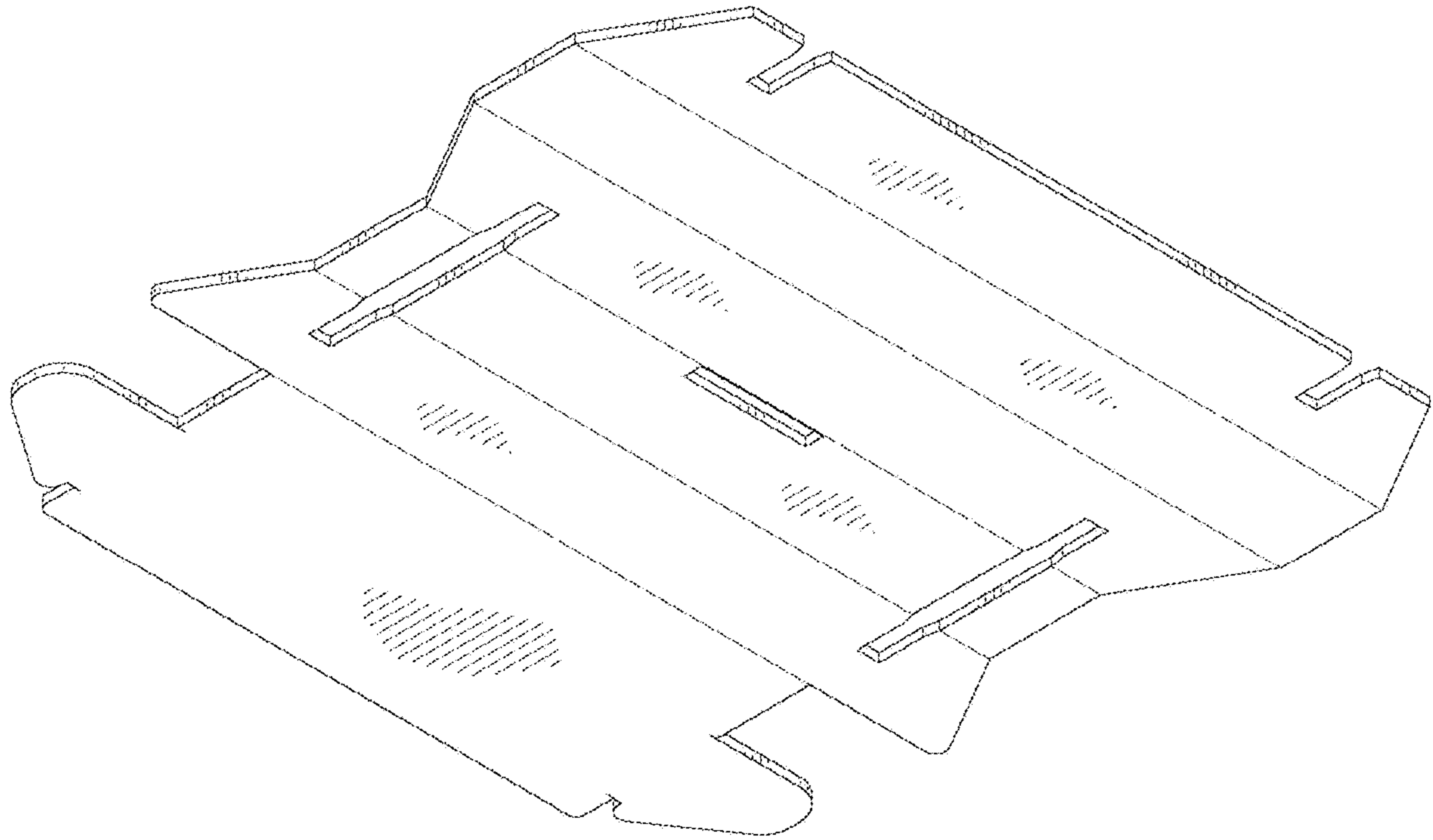

FIG. 26

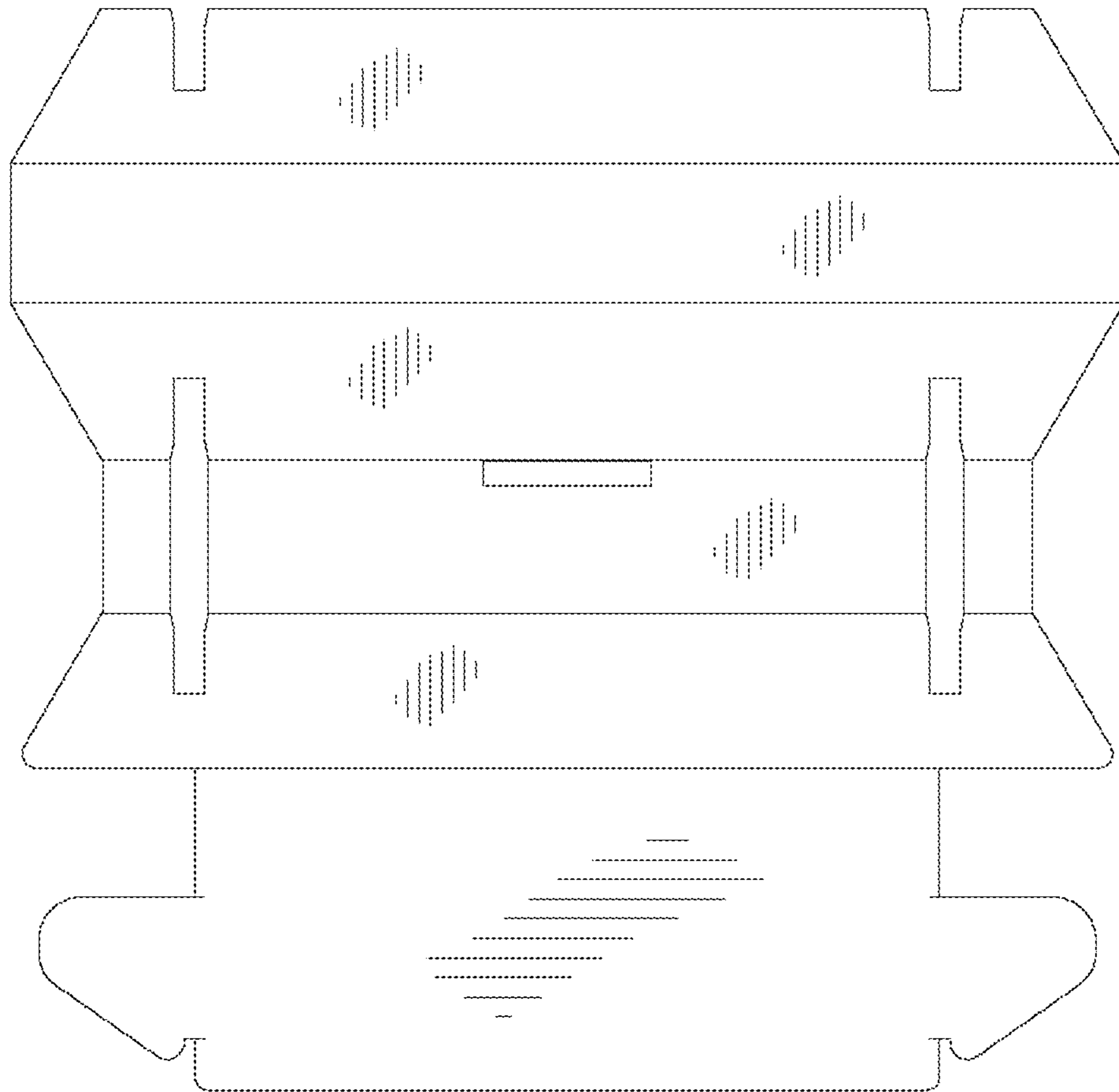

FIG. 27

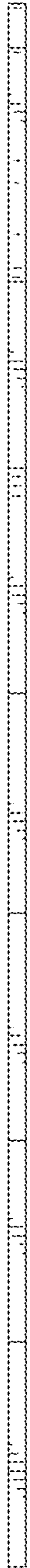

FIG. 28

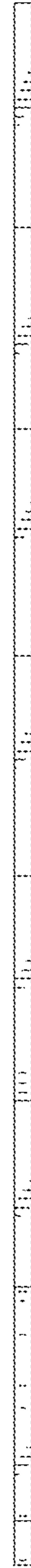

FIG. 29

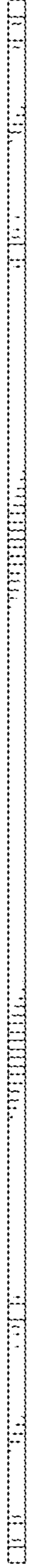

FIG. 30

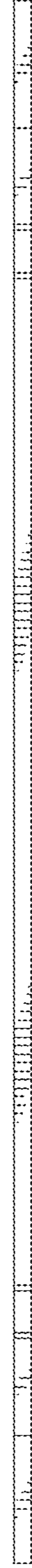

FIG. 31

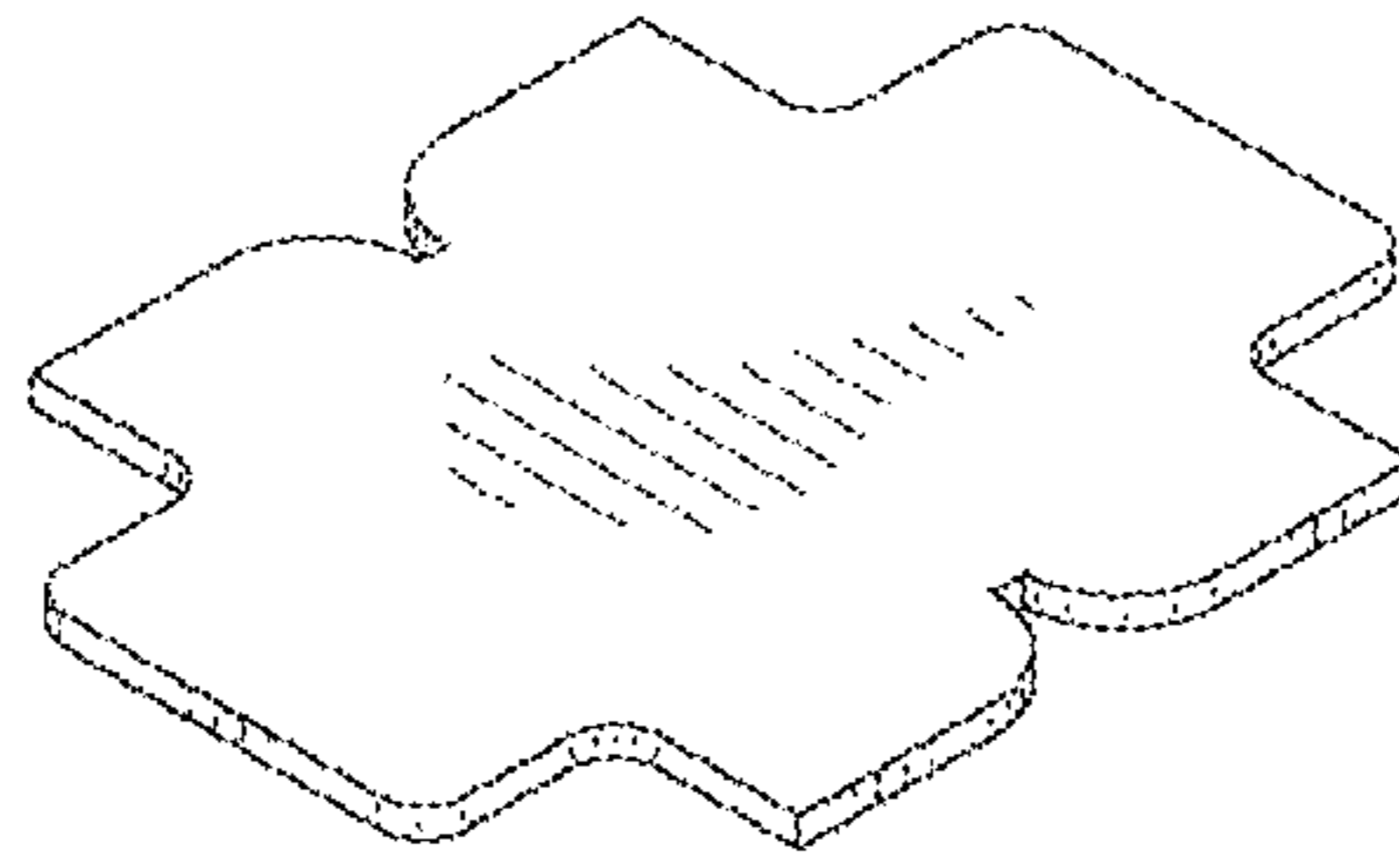

FIG. 32

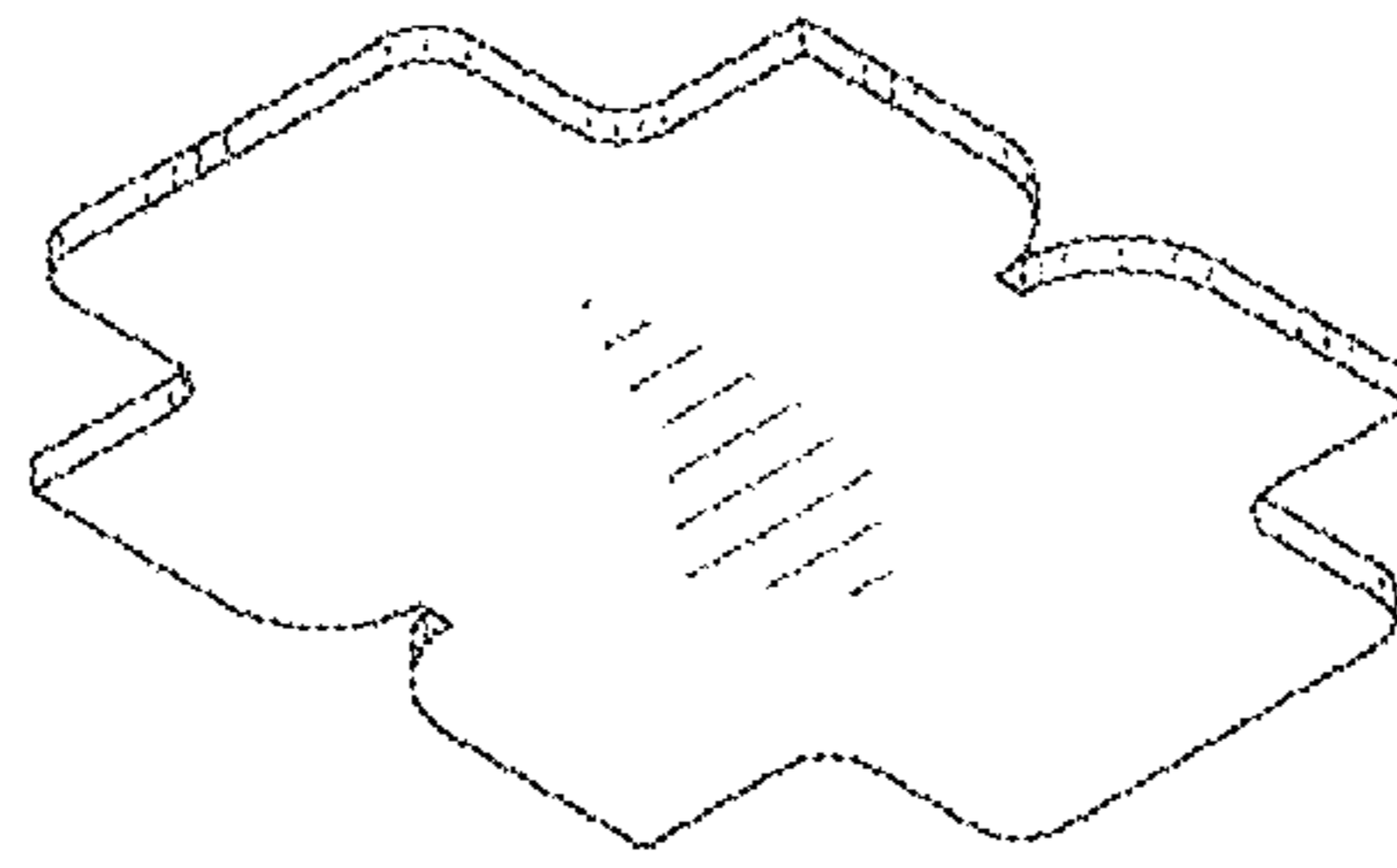

FIG. 33

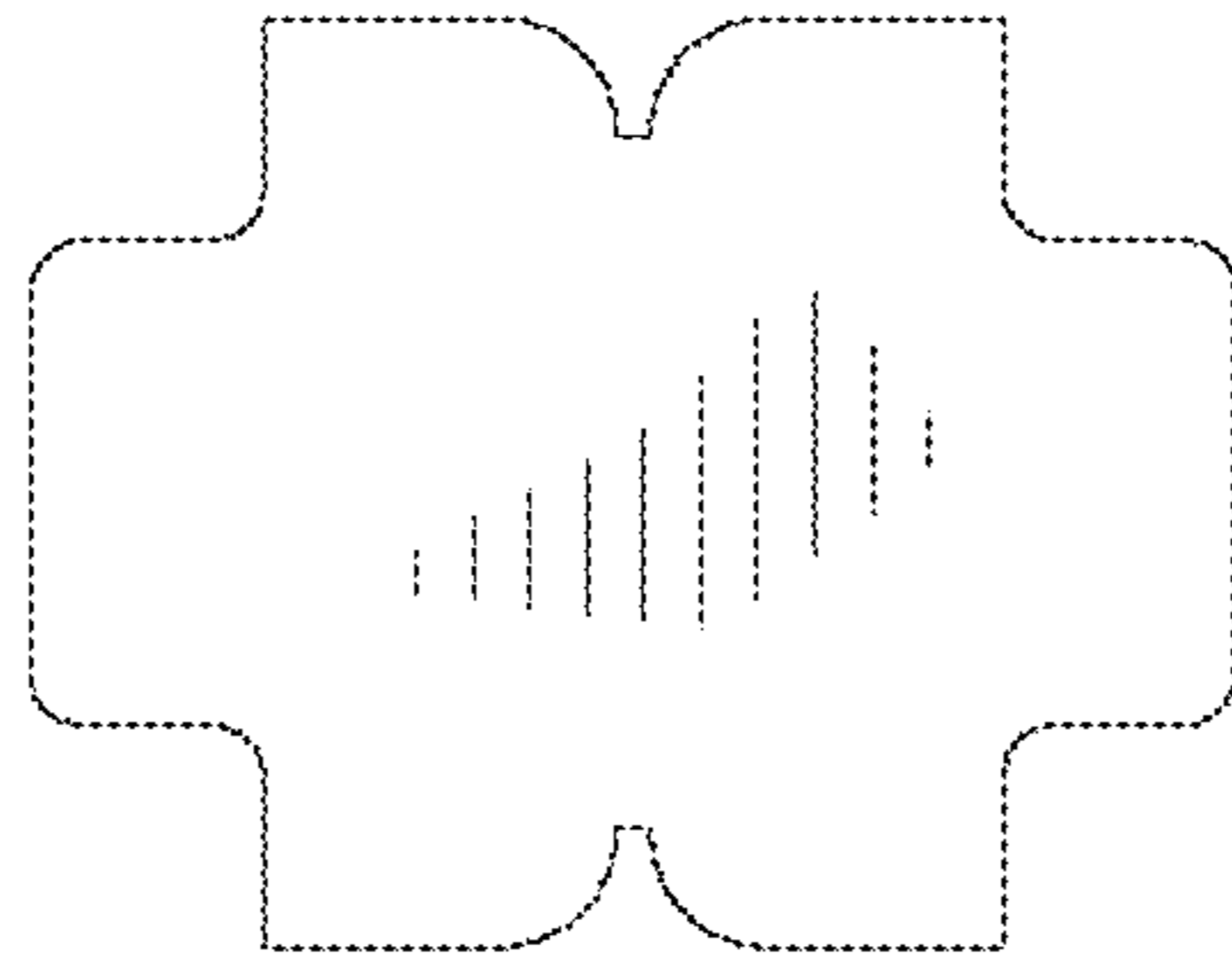

FIG. 34

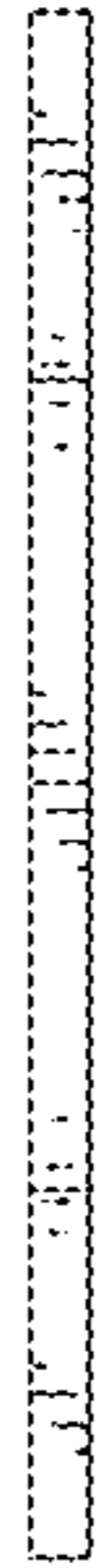

FIG. 35

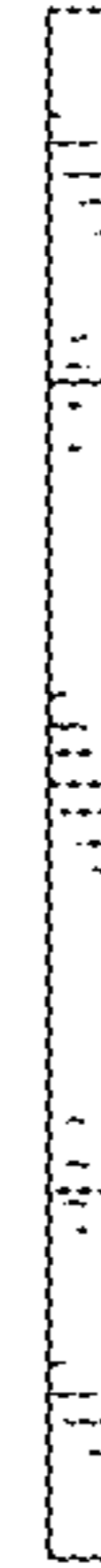

FIG. 36



FIG. 37

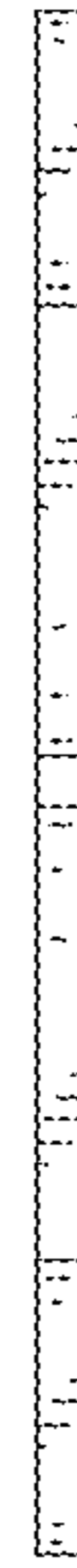

FIG. 38

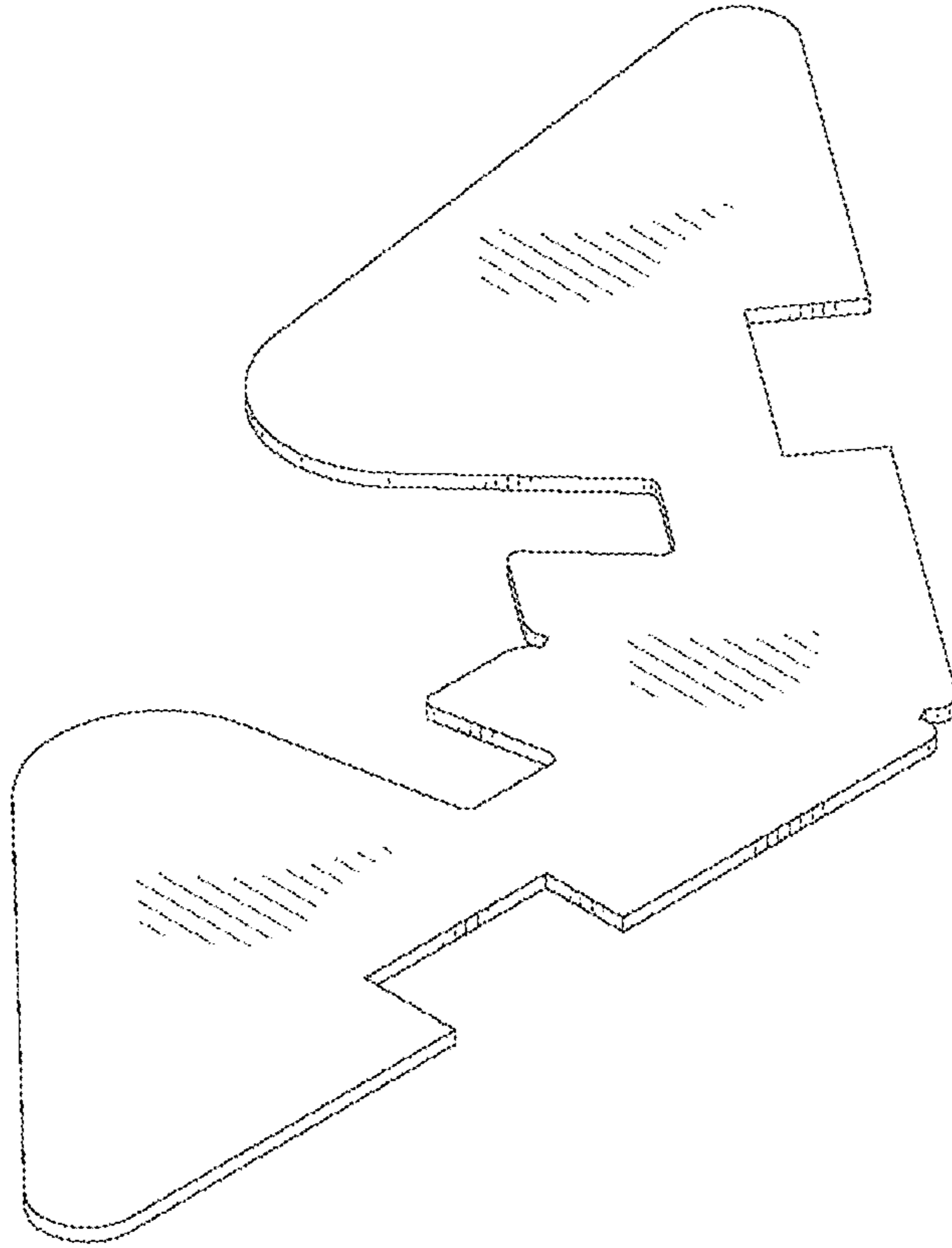

FIG. 39

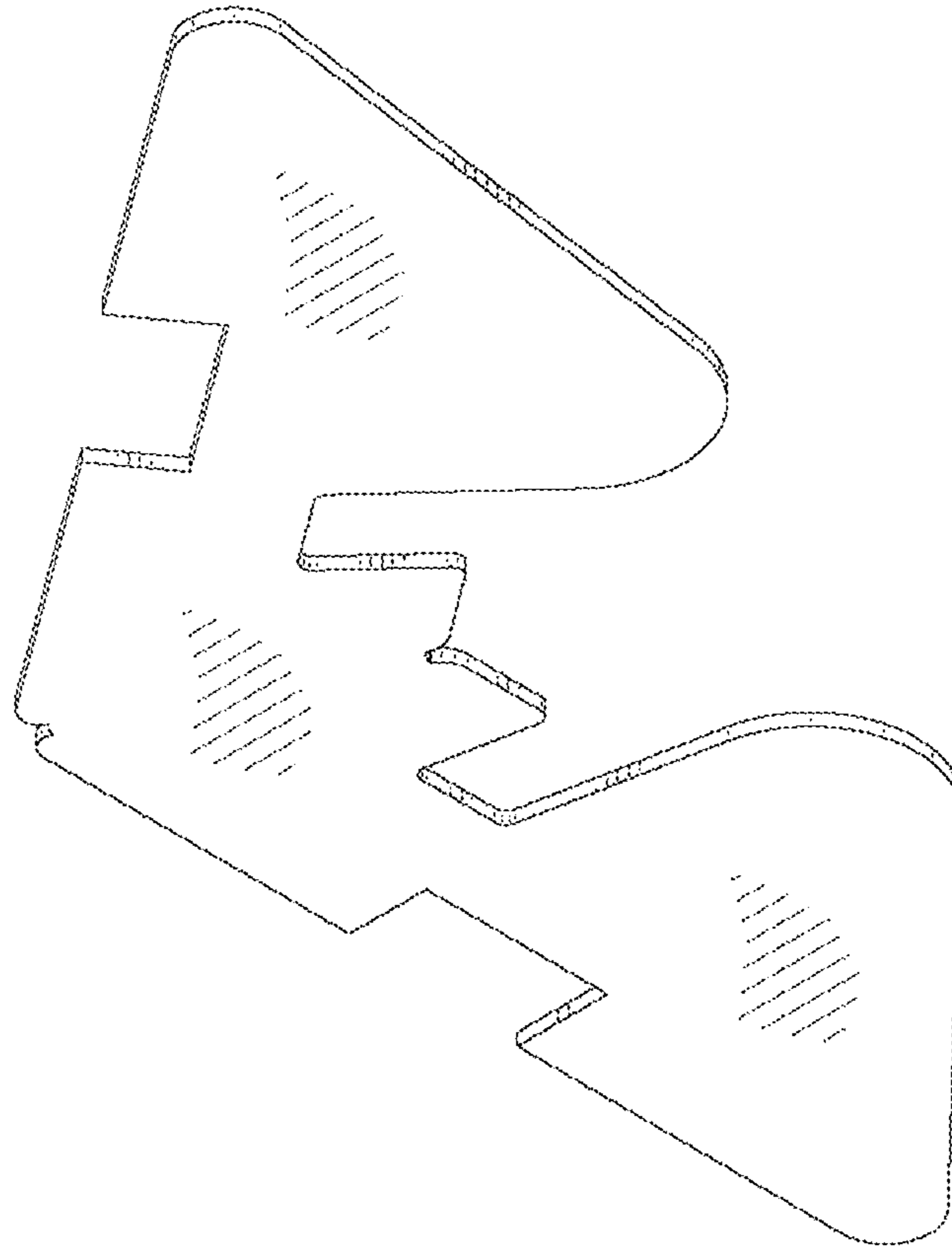

FIG. 40

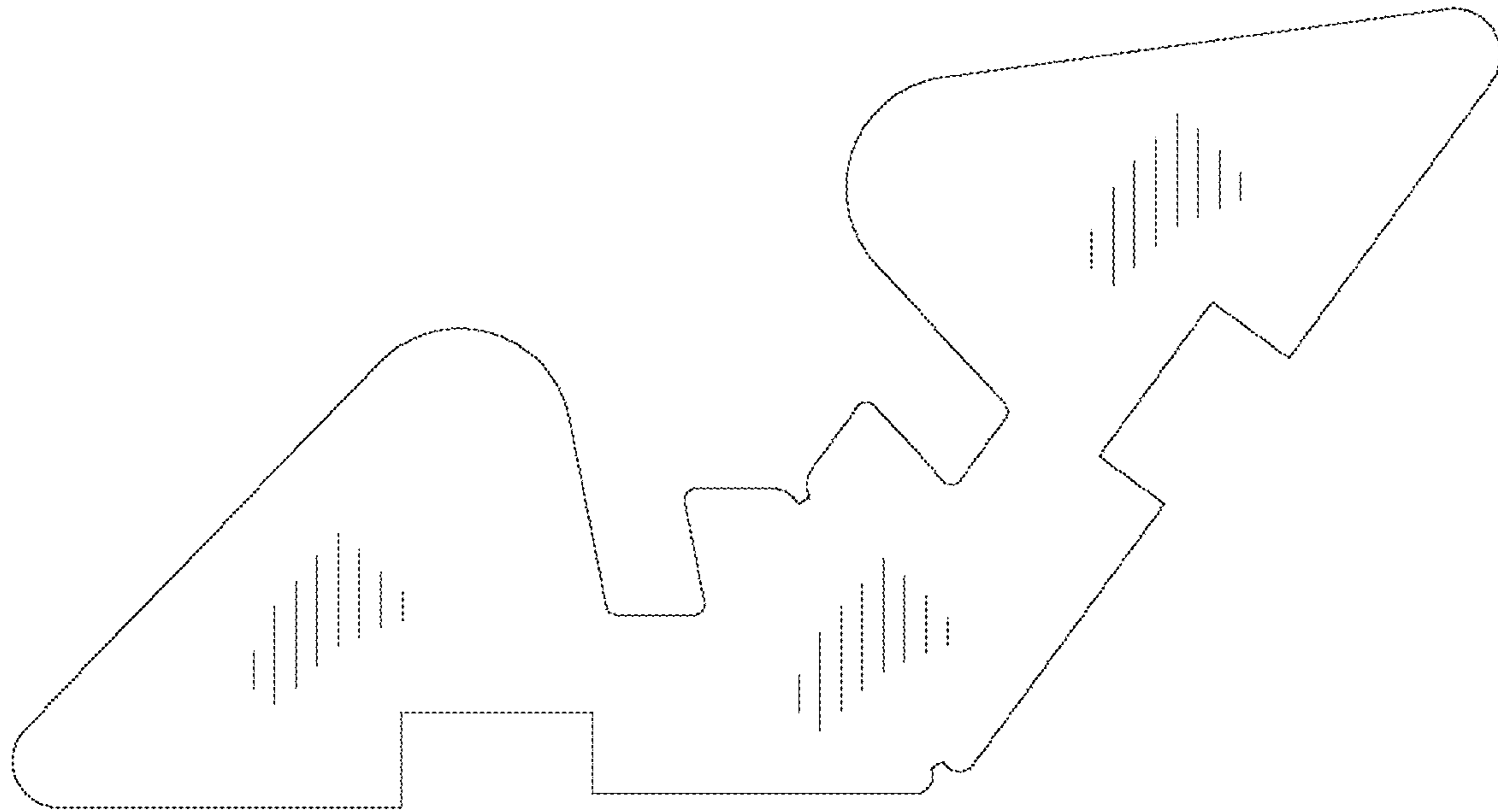

FIG. 41

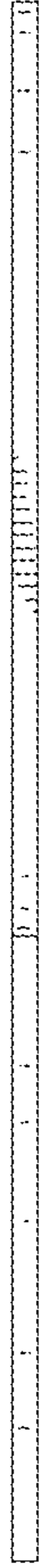

FIG. 42

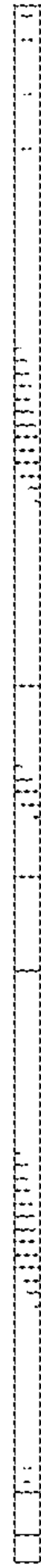

FIG. 43



FIG. 44



FIG. 45