



US00D918853S

(12) **United States Design Patent** (10) **Patent No.:** **US D918,853 S**  
**Kim et al.** (45) **Date of Patent:** **\*\* May 11, 2021**

(54) **TELEVISION**

(56) **References Cited**

(71) Applicant: **LG ELECTRONICS INC**, Seoul (KR)

U.S. PATENT DOCUMENTS

(72) Inventors: **Jongchul Kim**, Seoul (KR);  
**Hyoungwon Kim**, Seoul (KR);  
**Yooseok Kim**, Seoul (KR); **Younsoo Kim**, Seoul (KR)

D561,712 S *	2/2008	Chu	.....	D14/126
D692,403 S *	10/2013	Takami	.....	D14/126
D700,586 S *	3/2014	Kim	.....	D14/126
D703,168 S *	4/2014	Won	.....	D14/126
D714,238 S *	9/2014	Kim	.....	D14/126
D719,119 S *	12/2014	Park	.....	D14/126
D720,315 S *	12/2014	Kim	.....	D14/126
D722,033 S *	2/2015	Kim	.....	D14/126
D722,989 S *	2/2015	Park	.....	D14/126
D733,082 S *	6/2015	Hwangbo	.....	D14/126
D748,596 S *	2/2016	McManigal	.....	D14/126
D751,519 S *	3/2016	Ma	.....	D14/126
D754,086 S *	4/2016	Valeur	.....	D14/126

(73) Assignee: **LG Electronics Inc.**, Seoul (KR)

(\*\*) Term: **15 Years**

(21) Appl. No.: **35/508,636**

(22) Filed: **Aug. 21, 2019**

(Continued)

(80) **Hague Agreement Data**

*Primary Examiner* — Richard E Chilcot

Int. Filing Date: **Aug. 21, 2019**

(74) *Attorney, Agent, or Firm* — Birch, Stewart, Kolasch & Birch, LLP

Int. Reg. No.: **DM/204268**

Int. Reg. Date: **Aug. 21, 2019**

Int. Reg. Pub. Date: **Feb. 14, 2020**

(30) **Foreign Application Priority Data**

Feb. 26, 2019 (KR) ..... 30-2019-0008466

(51) **LOC (13) Cl.** ..... **14-03**

(52) **U.S. Cl.**

USPC ..... **D14/126**

CPC ..... **B64D 11/00154** (2014.12)

(58) **Field of Classification Search**

USPC ..... D14/125-137, 140.11, 217, 239,  
D14/314-316, 322, 326, 334-336,  
D14/339-341, 371, 373, 374, 379, 432,  
D14/440, 448, 450, 485, 492, 138 G, 248;  
D21/329, 321, 324, 333, 369, 370, 371,  
D21/515; D6/300, 310, 314, 320, 332,  
D6/356, 553; D10/15, 75, 80, 104.1,  
D10/109.1, 109.2, 121

CPC ..... G06F 1/18; H04N 7/18; B64D 11/00152;  
B64D 11/00154; B60R 11/0229; B60R  
11/02; B60R 2011/0017

See application file for complete search history.

(57) **CLAIM**

The ornamental design for a television, as shown and described.

**DESCRIPTION**

1. Television
- 1.1 : Perspective
- 1.2 : Front
- 1.3 : Back
- 1.4 : Left
- 1.5 : Right
- 1.6 : Top
- 1.7 : Bottom
- 1.8 : Enlarged
- 1.9 : Enlarged

The broken lines indicate portions of the article that form no part of the claimed design; reproductions **1.8** and **1.9** are enlarged views showing portions indicated by the squares in dot-dashed lines, the leading lines and the reference characters **1.8** and **1.9** on reproductions **1.1** and **1.4**, respectively.

**1 Claim, 9 Drawing Sheets**

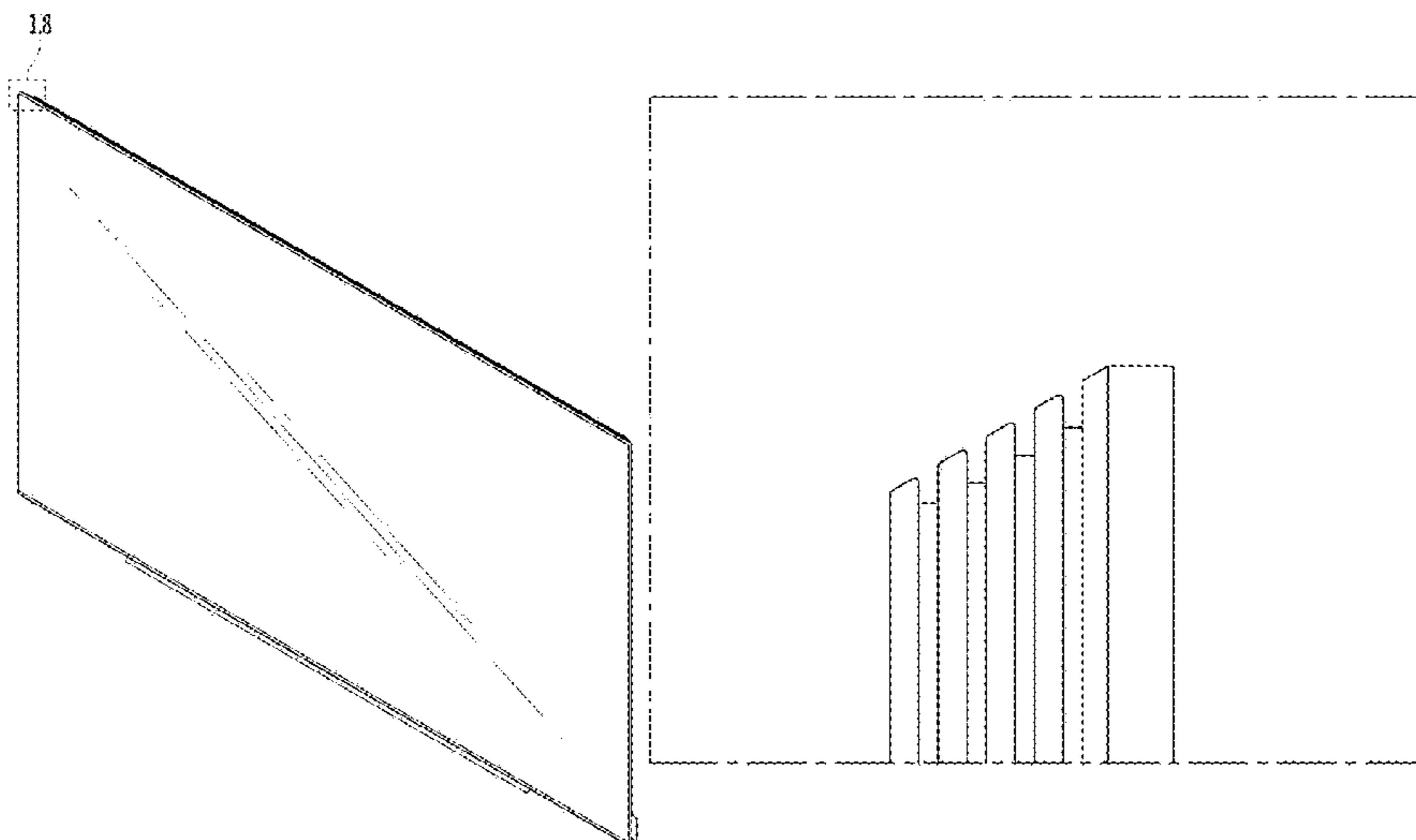

(56)

**References Cited**

## U.S. PATENT DOCUMENTS

D755,140	S	*	5/2016	Kim	.....	D14/126
D756,945	S	*	5/2016	Kim	.....	D14/126
D768,100	S	*	10/2016	Seo	.....	D14/126
D772,830	S	*	11/2016	Kim	.....	D14/126
D773,419	S	*	12/2016	Han	.....	D14/126
D774,484	S	*	12/2016	Han	.....	D14/126
D775,094	S	*	12/2016	Kim	.....	D14/126
D778,854	S	*	2/2017	Lee	.....	D14/126
D778,855	S	*	2/2017	Lee	.....	D14/126
D780,140	S	*	2/2017	Kim	.....	D14/126
D782,991	S	*	4/2017	Kim	.....	D14/126
D785,581	S	*	5/2017	McManigal	.....	D14/126
D786,813	S	*	5/2017	McManigal	.....	D14/126
D787,462	S	*	5/2017	Shiono	.....	D14/126
D790,493	S	*	6/2017	Han	.....	D14/126
D792,361	S	*	7/2017	Han	.....	D14/126
D826,878	S	*	8/2018	Kim	.....	D14/126
D836,587	S	*	12/2018	Cha	.....	D14/126
D847,772	S	*	5/2019	Kim	.....	D14/126
D847,773	S	*	5/2019	Kim	.....	D14/126
D848,386	S	*	5/2019	Kuwao	.....	D14/126
D848,965	S	*	5/2019	Kim	.....	D14/126
D901,414	S	*	11/2020	Park	.....	D14/126
D901,416	S	*	11/2020	Park	.....	D14/126

\* cited by examiner

1.1

1.8

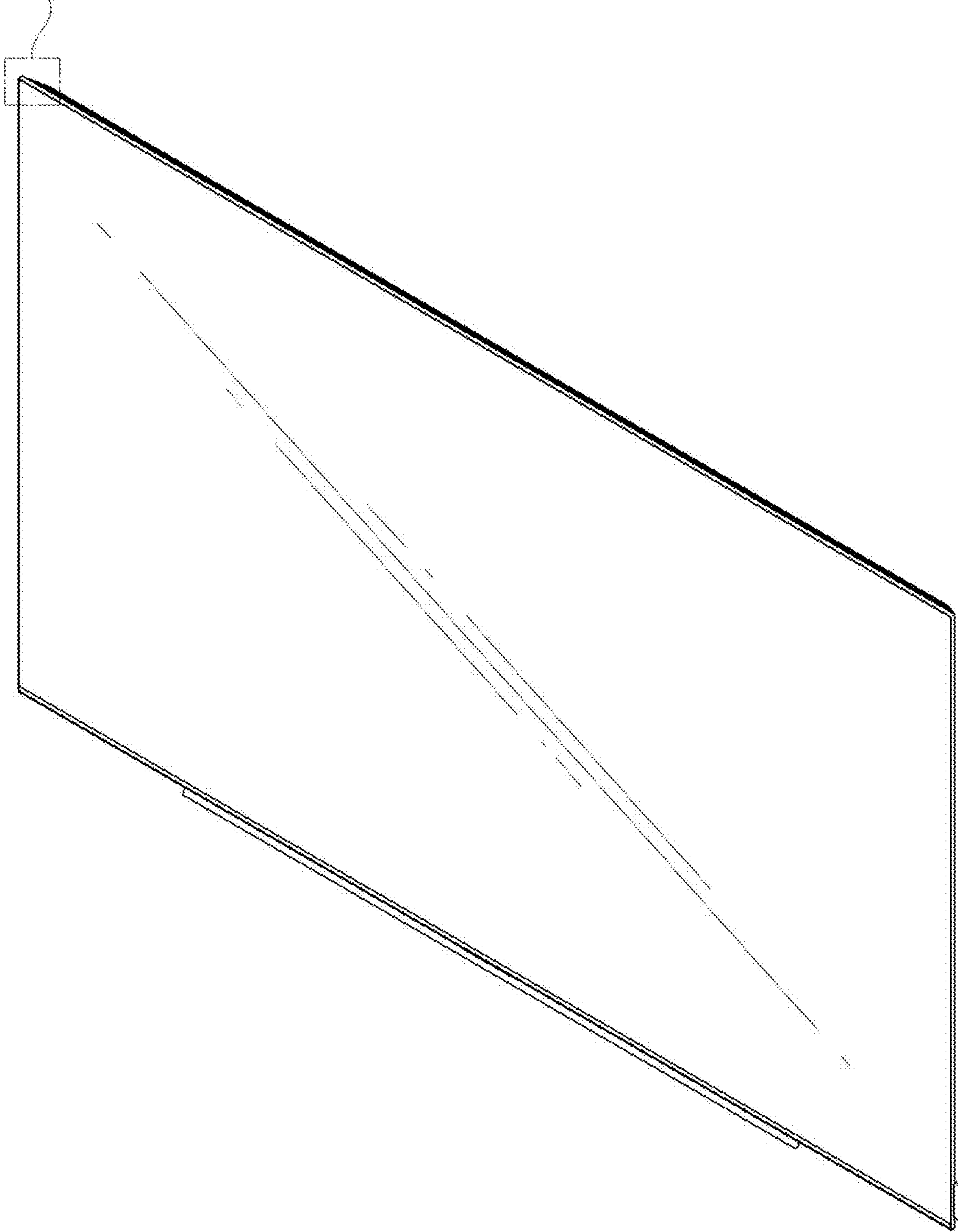

1.2

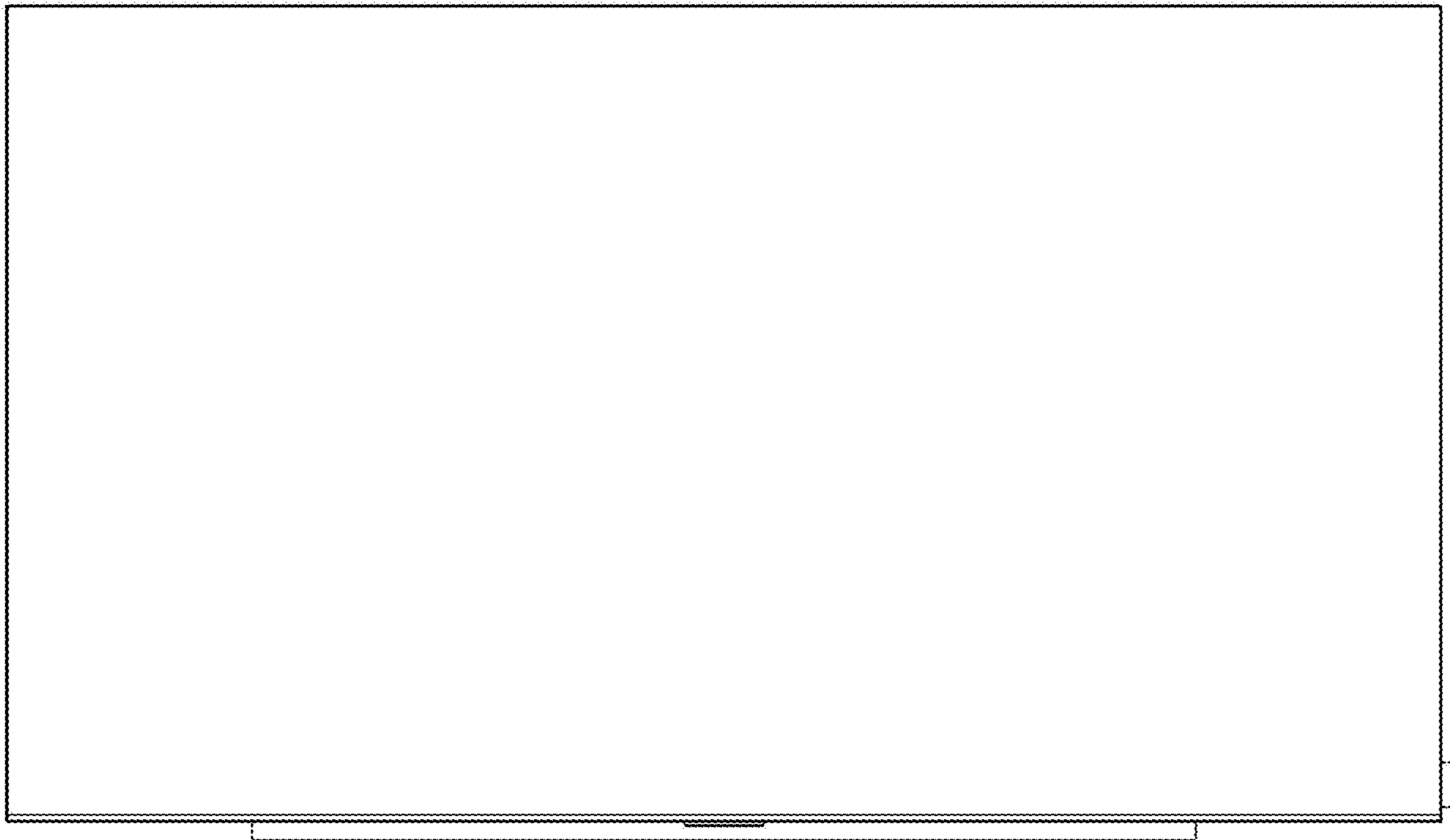

1.3

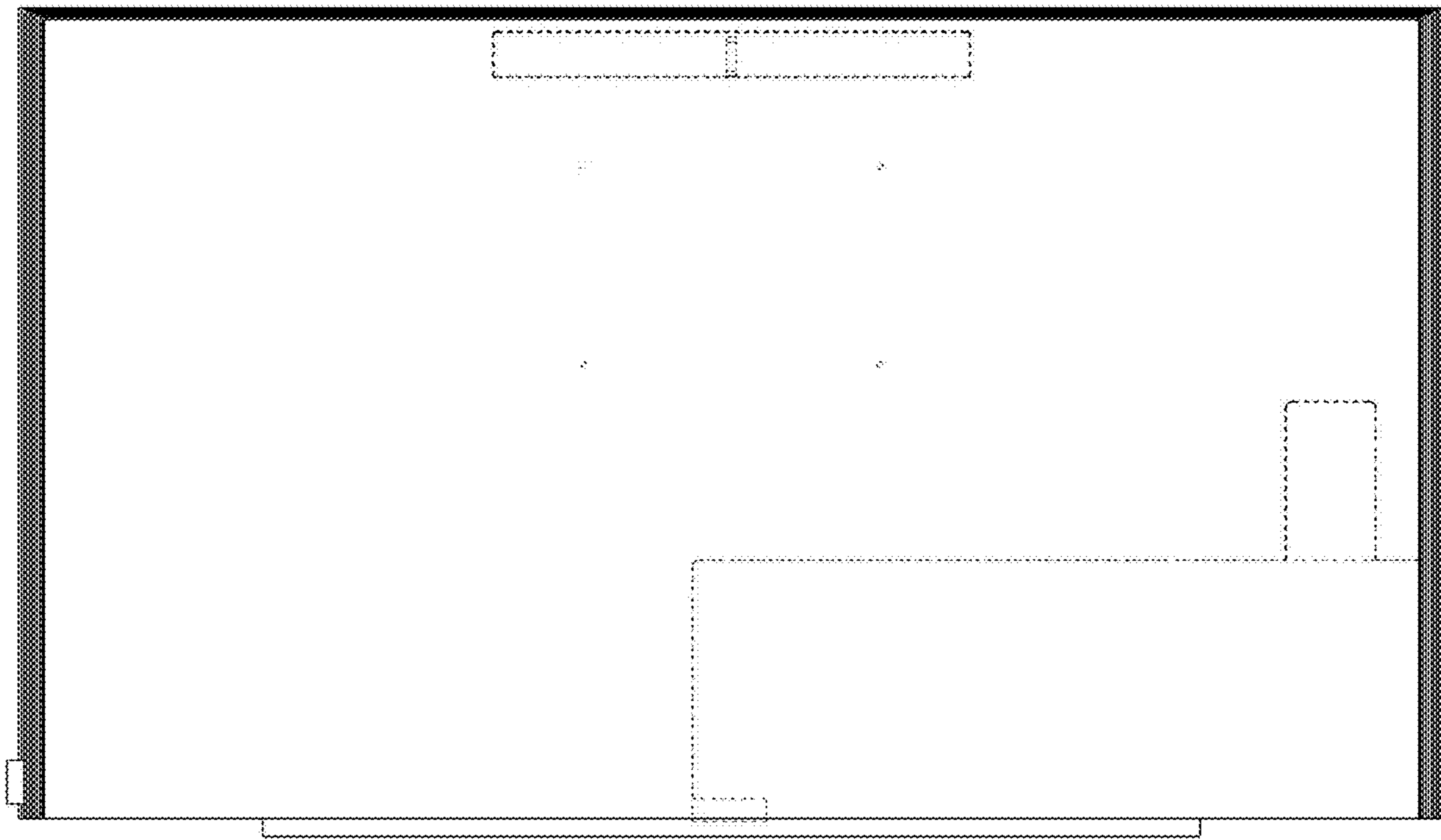

1.4

1.9

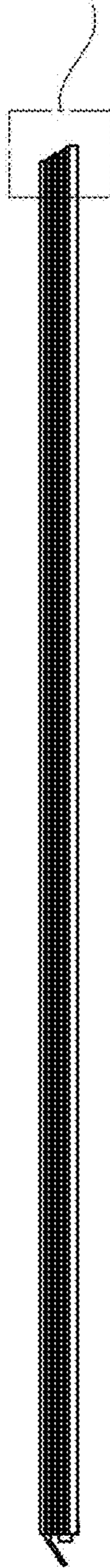

1.5



**1.6**





1.7

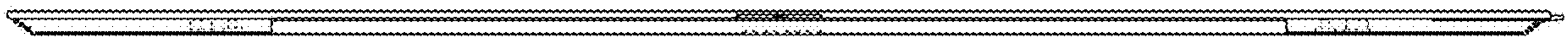

1.8

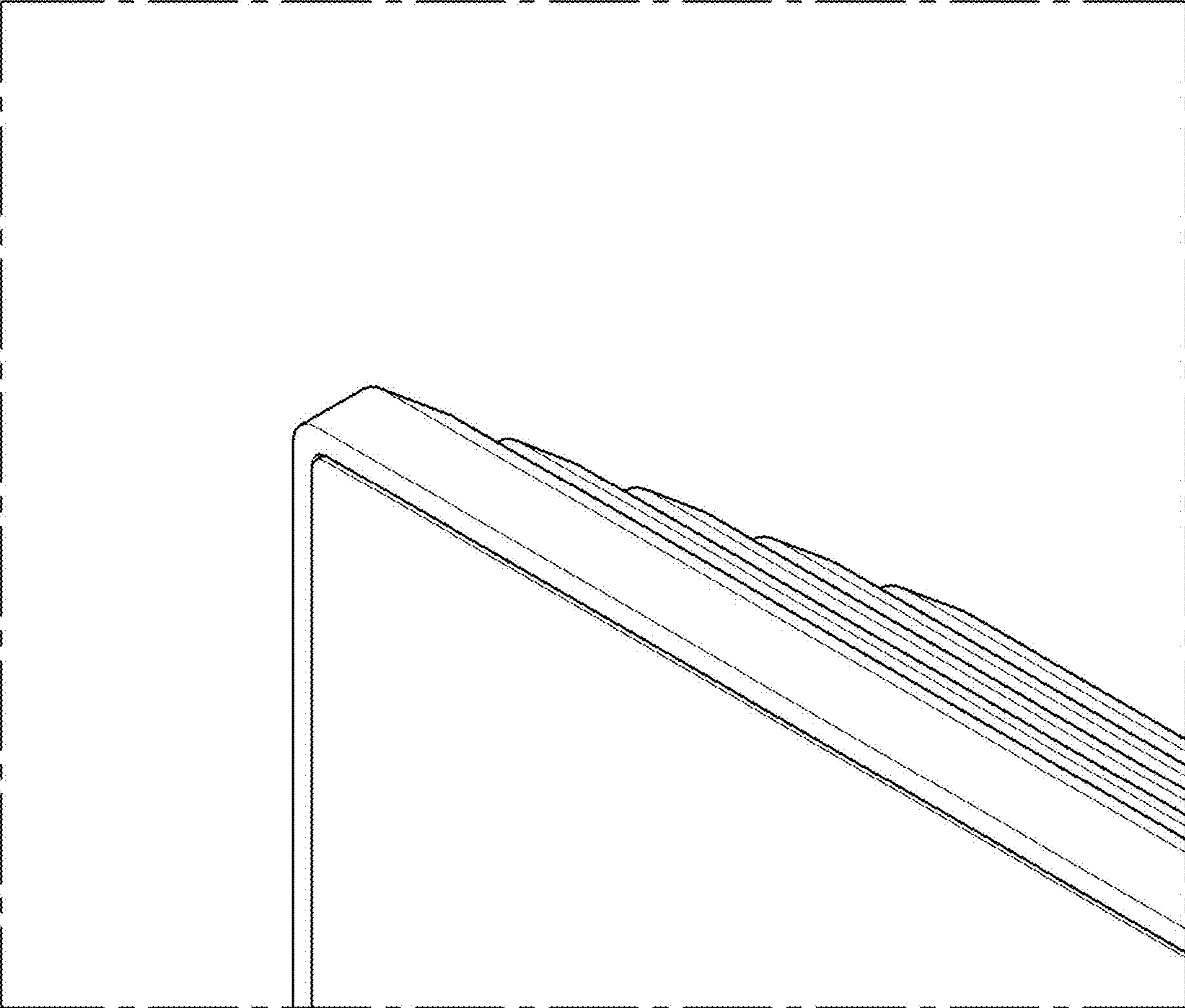

1.9

