



US00D918831S

(12) **United States Design Patent**
Zhang et al.

(10) **Patent No.:** **US D918,831 S**

(45) **Date of Patent:** **** May 11, 2021**

(54) **CHARGER FOR GAME CONSOLE**

(71) Applicant: **UGREEN GROUP LIMITED,**
Shenzhen (CN)

(72) Inventors: **Qingsen Zhang,** Shenzhen (CN);
Junling Chen, Shenzhen (CN);
Houling Wang, Shenzhen (CN)

(**) Term: **15 Years**

(21) Appl. No.: **29/745,804**

(22) Filed: **Aug. 10, 2020**

(51) **LOC (13) Cl.** **13-02**

(52) **U.S. Cl.**
USPC **D13/108**

(58) **Field of Classification Search**
USPC D13/103, 107–110, 118–119, 184, 199;
D14/251, 253, 432, 434
CPC .. H02J 50/00; H02J 50/10; H02J 50/12; H02J
50/80; H02J 7/025; H02J 7/005; H02J
7/0026; H02J 7/0042; H02J 7/0044; H02J
7/0045; H02J 7/0013; H02J 7/0003; H02J
50/40; H02J 50/402; H02J 7/007; H02J
7/0027

See application file for complete search history.

(56) **References Cited**

U.S. PATENT DOCUMENTS

D456,351 S * 4/2002 Yoneda D13/108
D526,973 S * 8/2006 Gates D13/168

D548,688 S * 8/2007 Fee D13/107
D608,277 S * 1/2010 Cano D13/108
D642,522 S * 8/2011 Budike, Jr. D13/108
D678,193 S * 3/2013 Siminoff D13/108
D723,461 S * 3/2015 Chen D13/108
D760,648 S * 7/2016 Lee D13/108
D839,824 S * 2/2019 Parra D13/107
D874,399 S * 2/2020 Lockenwitz D13/108
D875,039 S * 2/2020 Parra D13/107
D892,728 S * 8/2020 Pan D13/107

* cited by examiner

Primary Examiner — Rosemary K Tarcza

(57) **CLAIM**

The ornamental design for a charger for game console, as shown and described.

DESCRIPTION

FIG. 1 is a front and top perspective view of a charger for game console, showing our new design;
FIG. 2 is a rear and top perspective view thereof;
FIG. 3 is a front elevational view thereof;
FIG. 4 is a rear elevational view thereof;
FIG. 5 is a left side elevational view thereof;
FIG. 6 is a right side elevational view thereof;
FIG. 7 is a top plan view thereof; and,
FIG. 8 is a bottom plan view thereof.
The broken lines in the figures illustrate portions of the article that form no part of the claimed design.

1 Claim, 8 Drawing Sheets

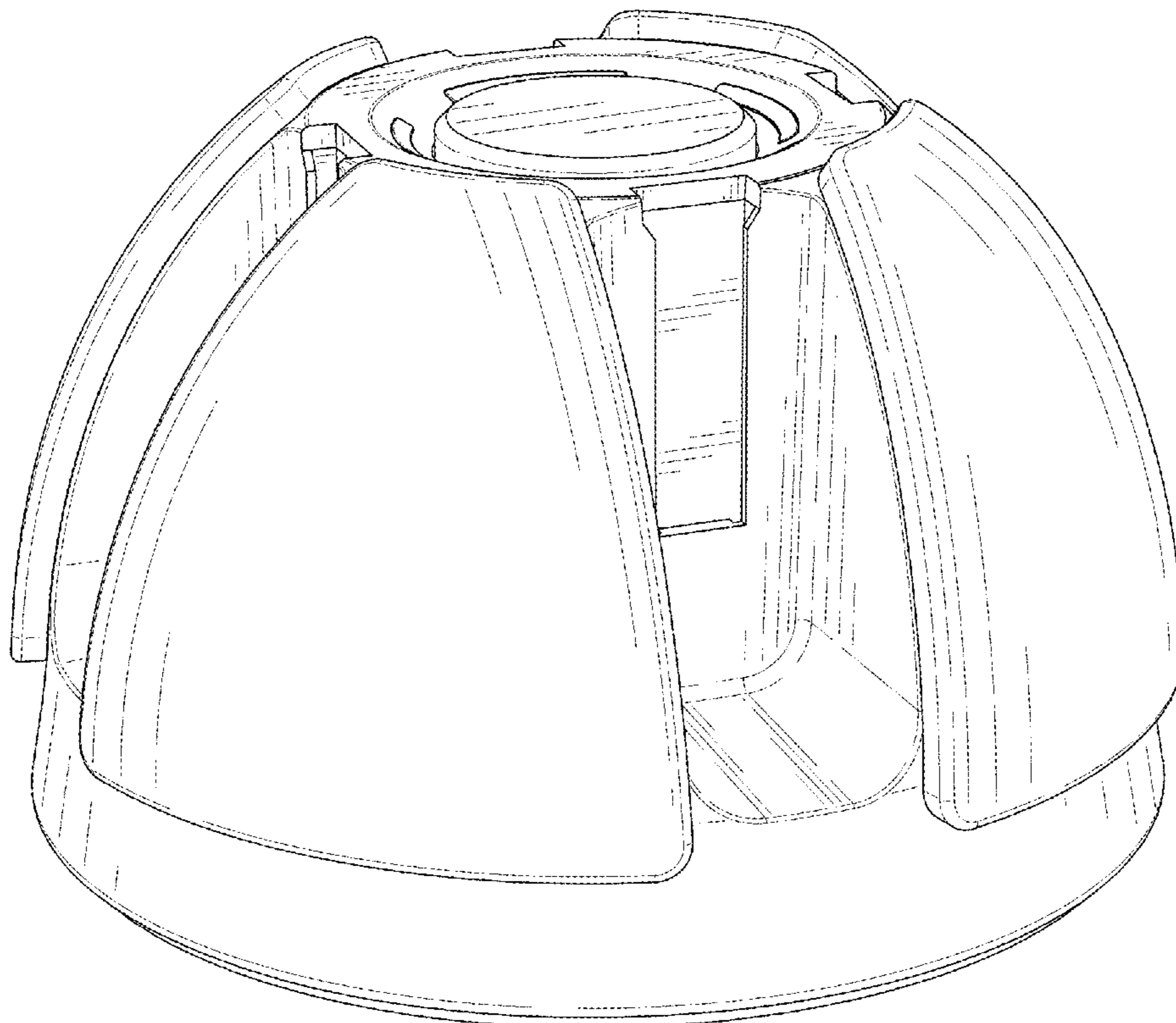

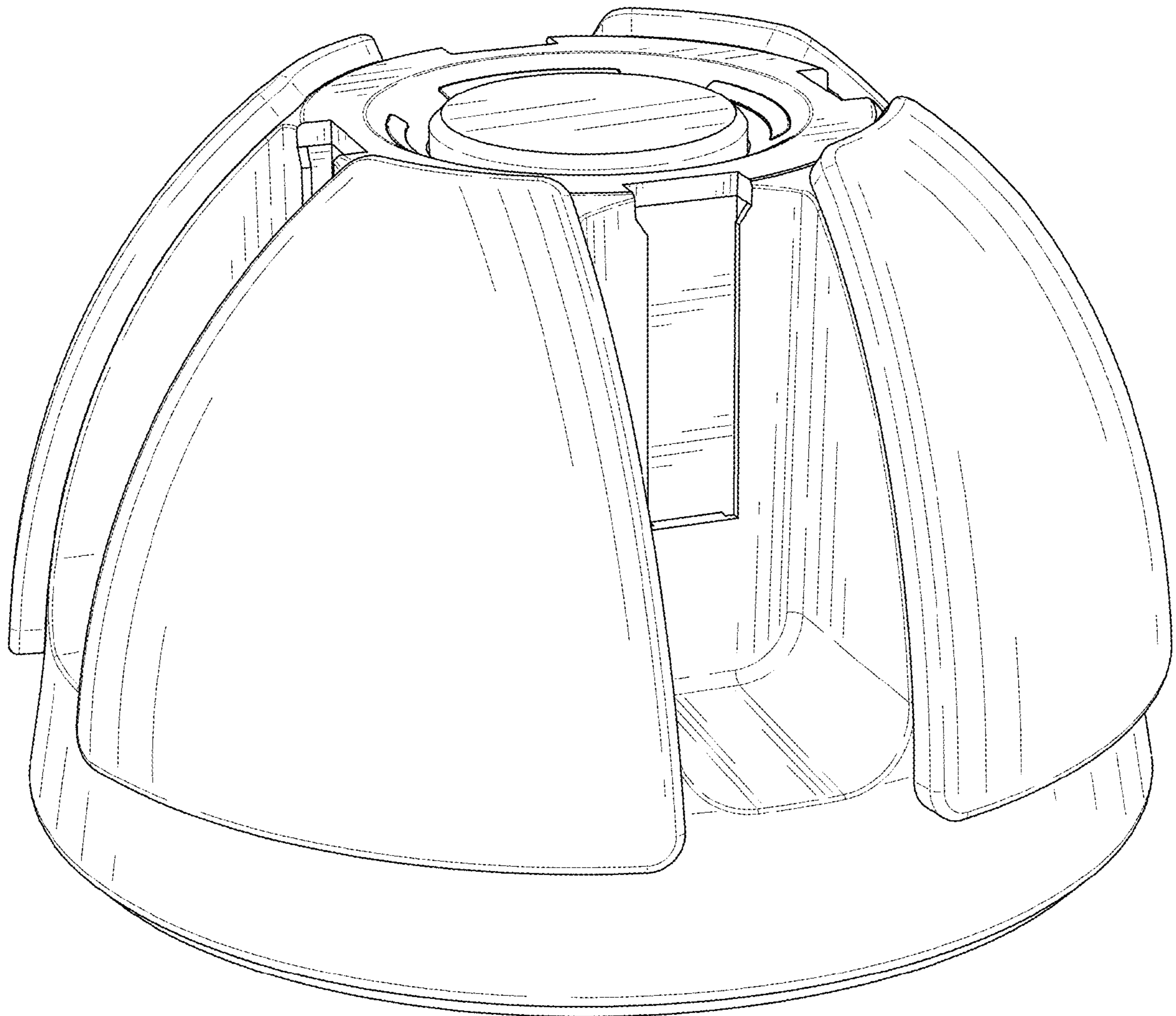

FIG. 1

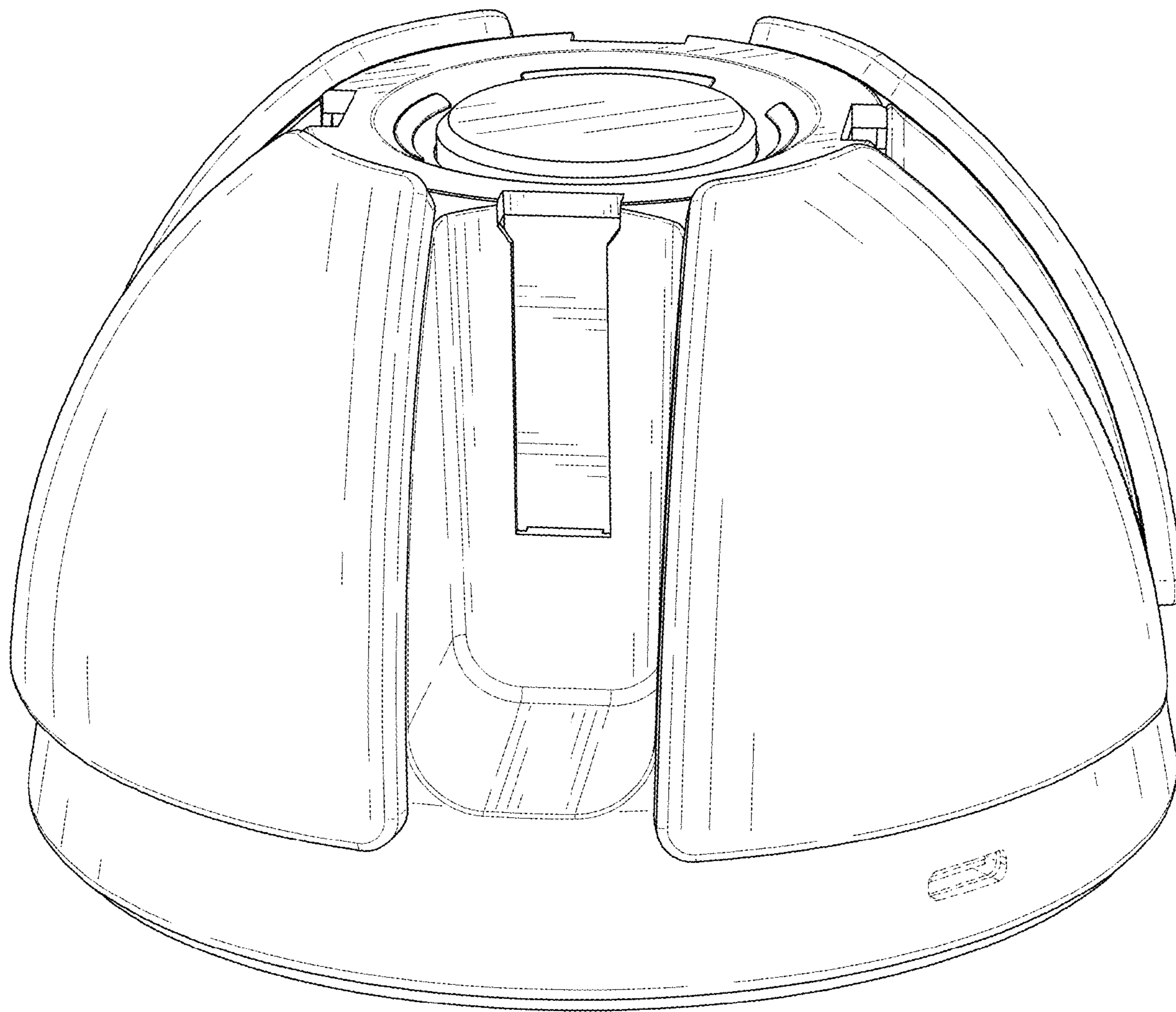

FIG. 2

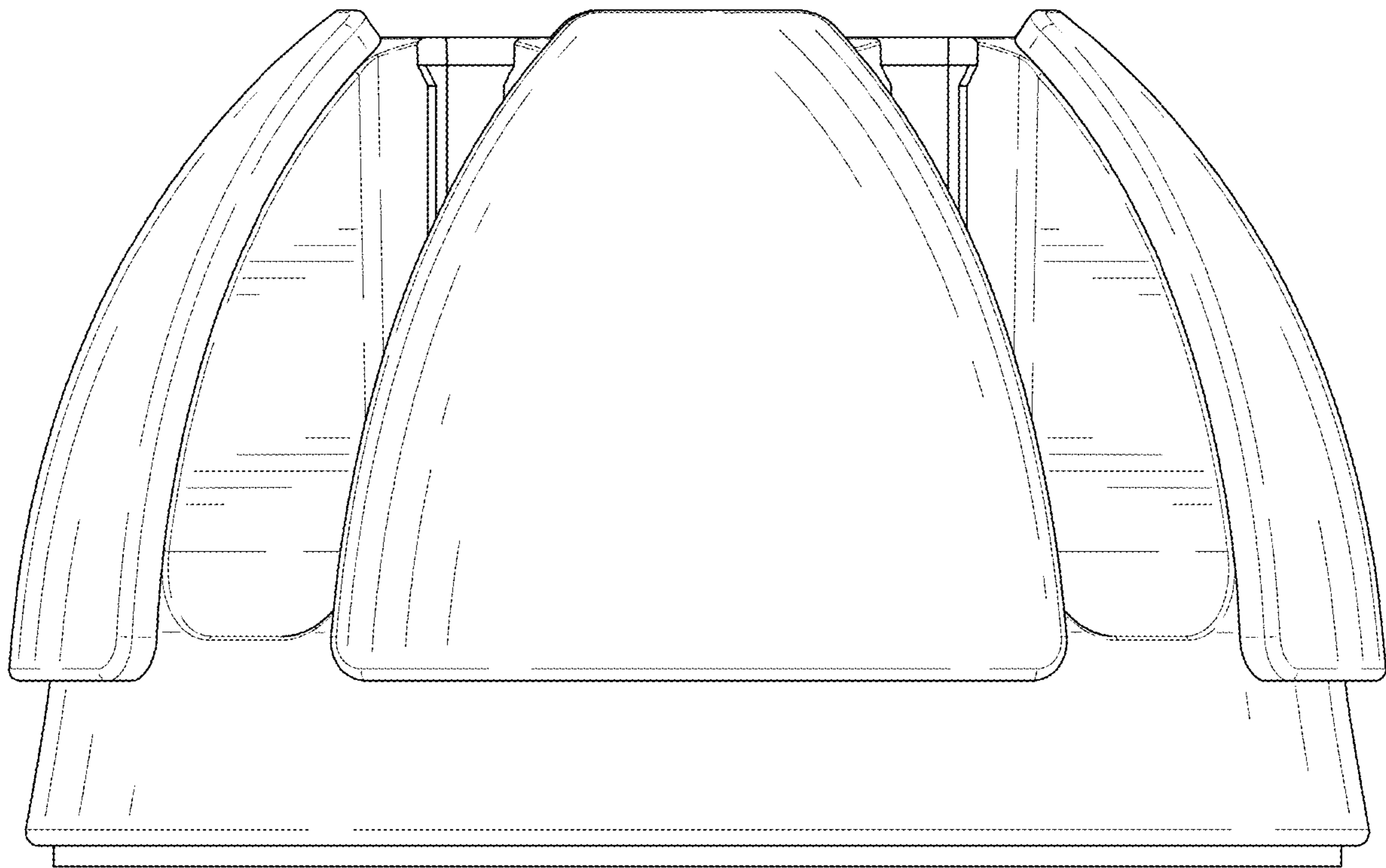

FIG. 3

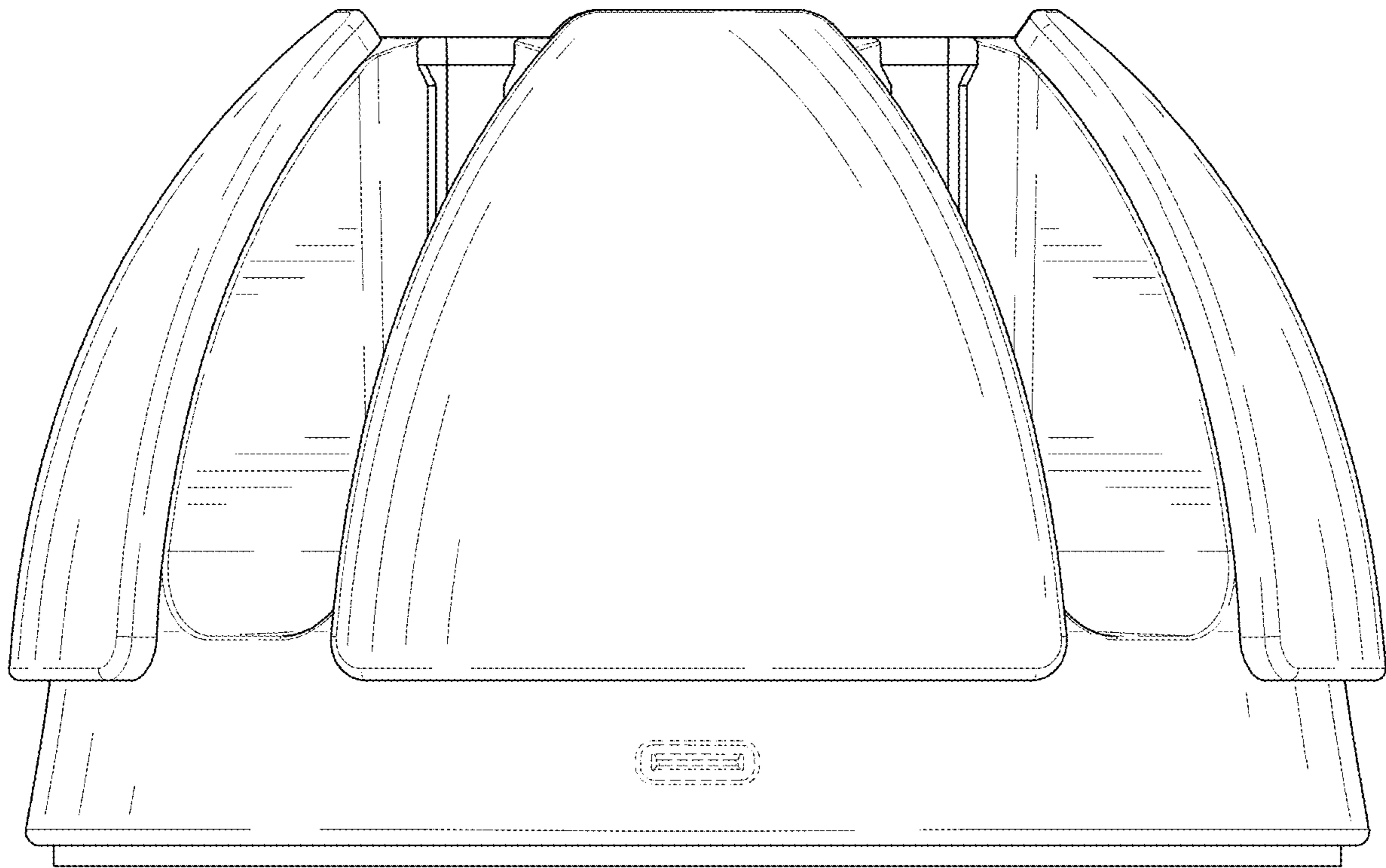

FIG. 4

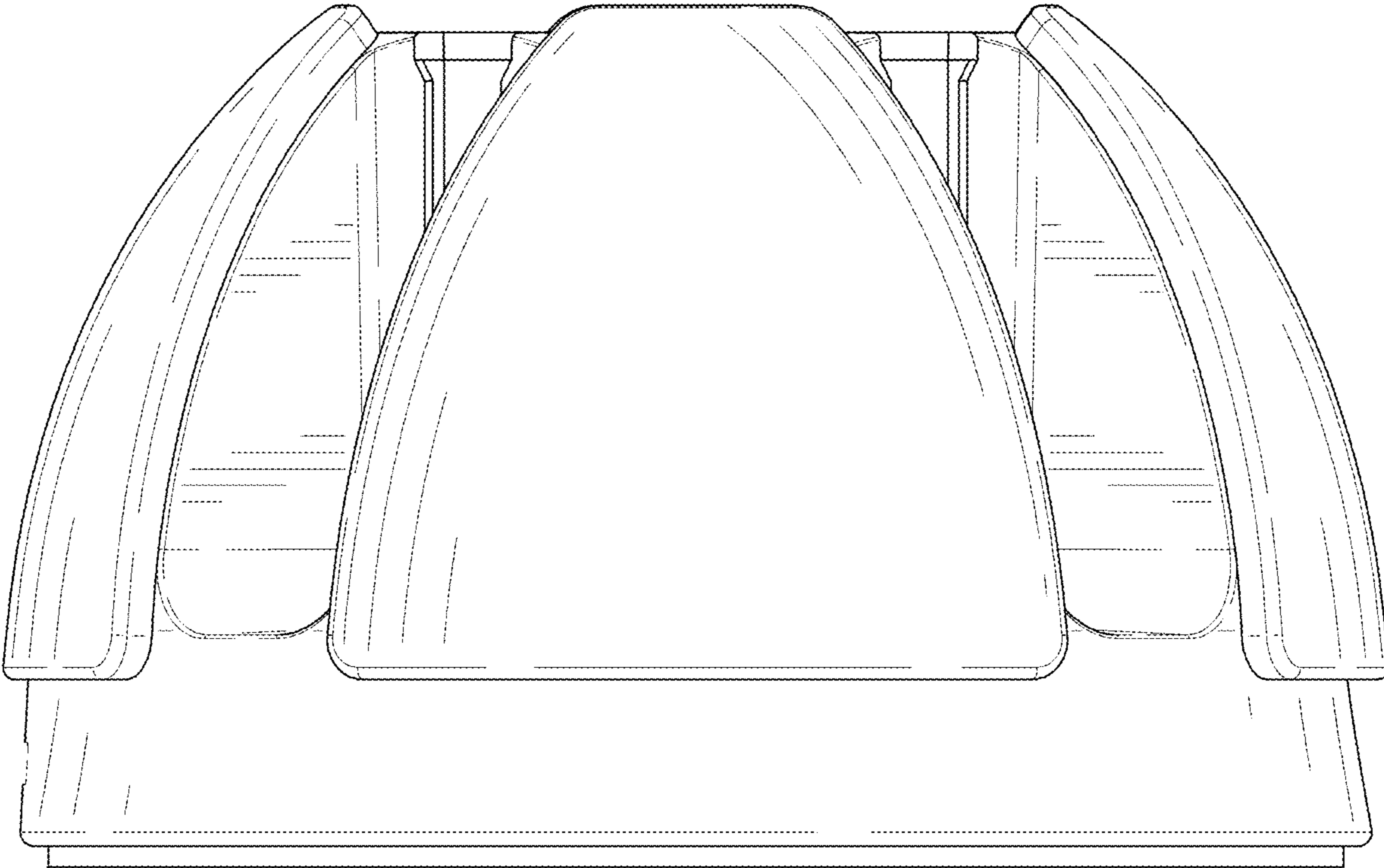

FIG. 5

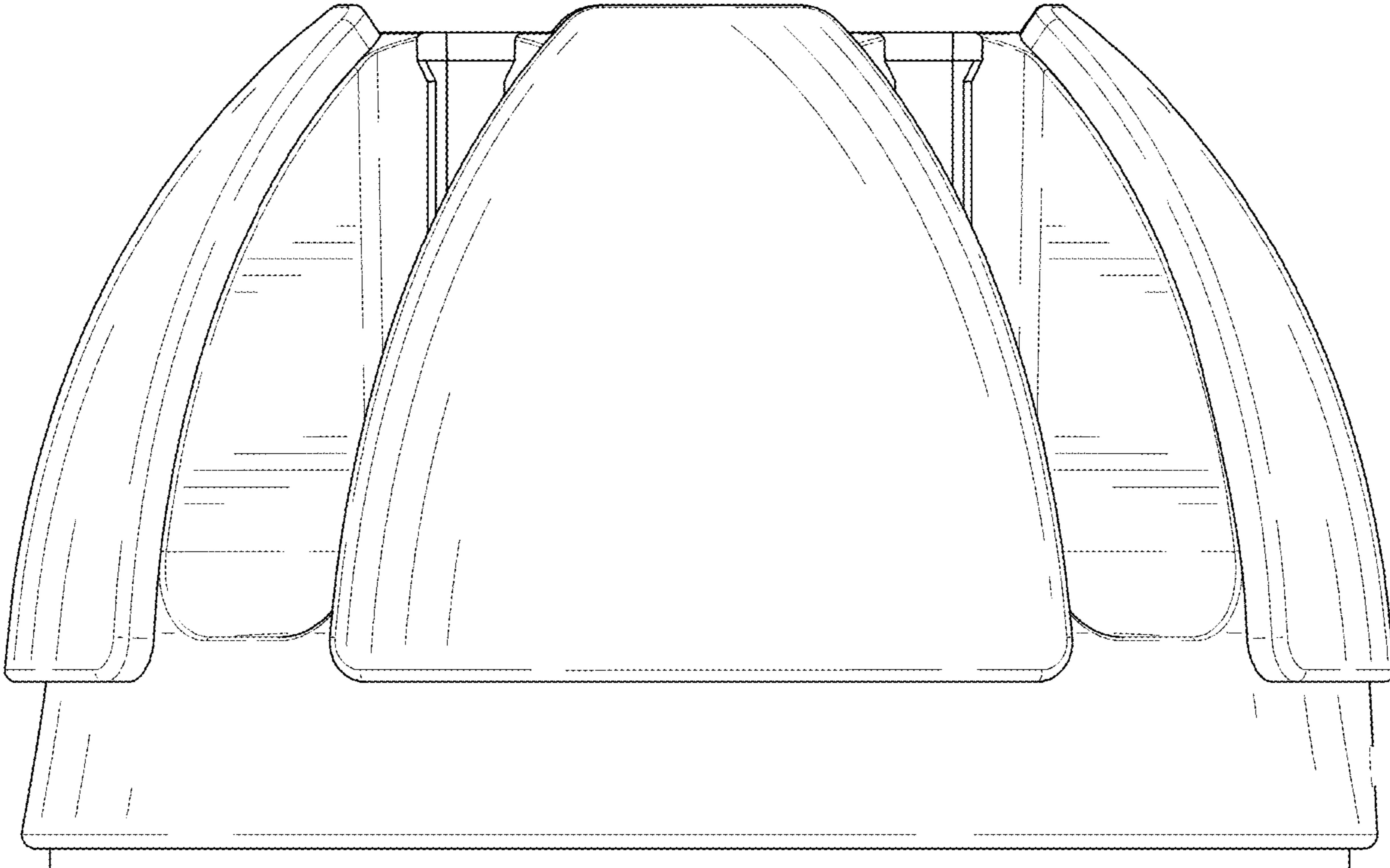

FIG. 6

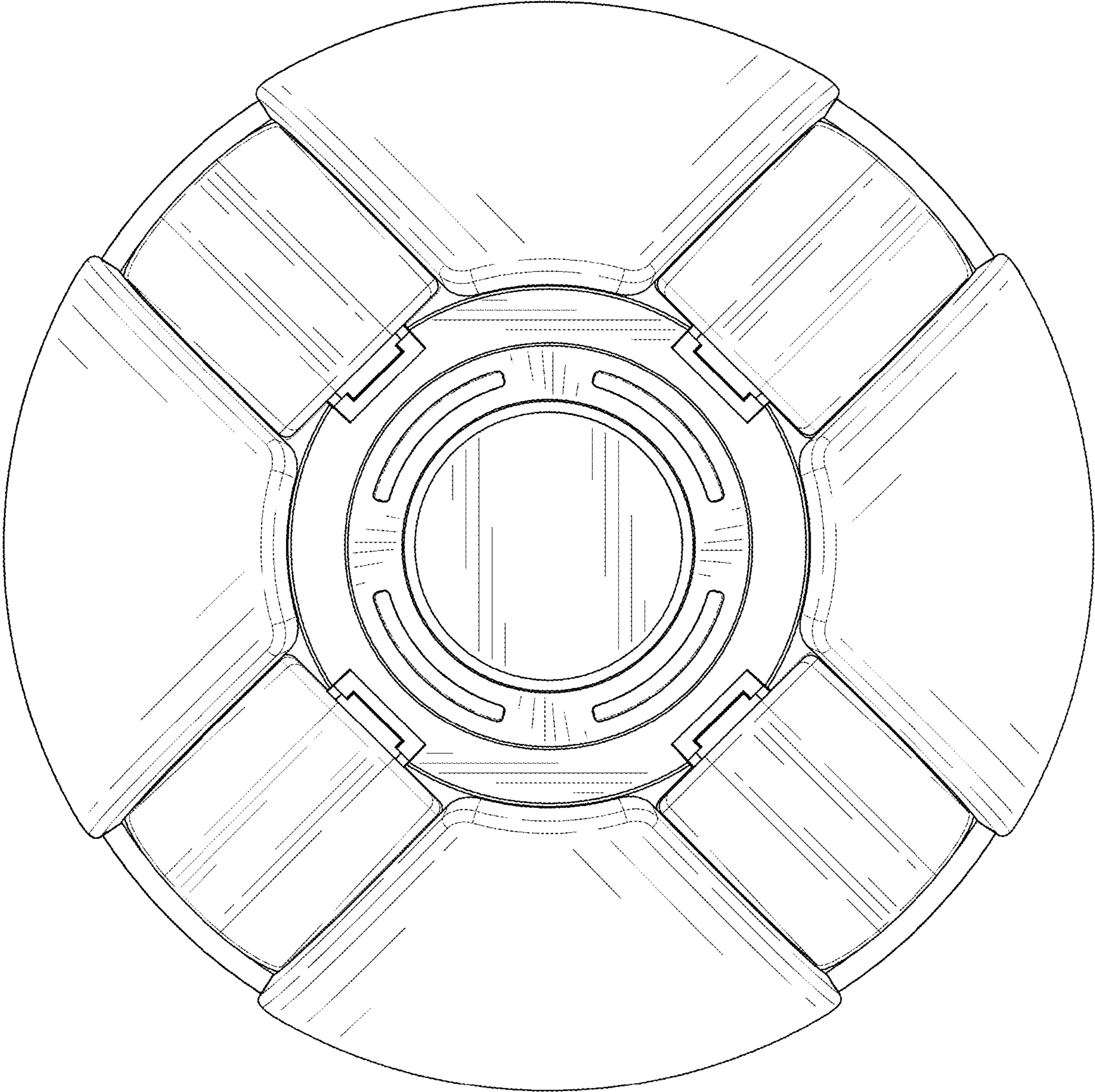

FIG. 7

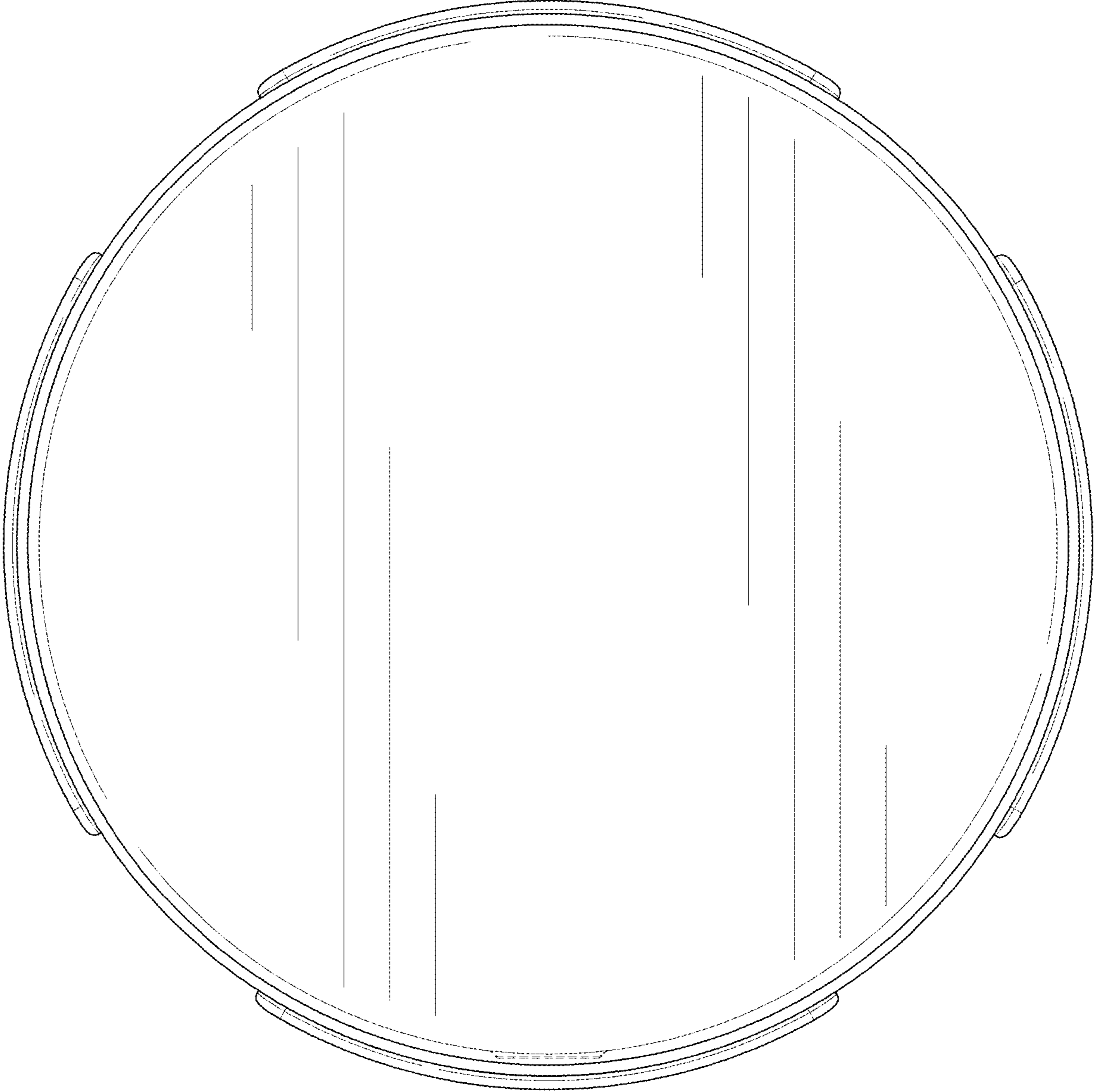

FIG. 8