



US00D918720S

(12) **United States Design Patent**
Jiang

(10) **Patent No.:** **US D918,720 S**

(45) **Date of Patent:** **** May 11, 2021**

(54) **TAMPER EVIDENT CHILD RESISTANT JAR**

(71) Applicant: **MEG Group**, Changzhou (CN)

(72) Inventor: **Min Jiang**, Jiangsu (CN)

(73) Assignee: **MEG Group**, Changzhou (CN)

(**) Term: **15 Years**

(21) Appl. No.: **29/710,503**

(22) Filed: **Oct. 23, 2019**

(30) **Foreign Application Priority Data**

Apr. 23, 2019 (CN) 201930189481.9
Jul. 29, 2019 (CN) 201930406976.2

(51) **LOC (13) Cl.** **09-01**

(52) **U.S. Cl.**

USPC **D9/504**; D9/500; D9/549

(58) **Field of Classification Search**

USPC D9/428, 454, 500–505, 516, 529, 537,
D9/545, 549, 551, 573–575, 688, 738,
(Continued)

(56) **References Cited**

U.S. PATENT DOCUMENTS

D272,722 S * 2/1984 Haakenson D9/503
D274,848 S * 7/1984 Chevassus D28/76
(Continued)

FOREIGN PATENT DOCUMENTS

KR 301013114.0000 * 7/2019
KR 301014655.0000 * 7/2019
SI 201150046-0001 * 11/2011

OTHER PUBLICATIONS

Barbara CT, Oct. 2, 2019, Amszon.com Review Post BITOMIC Glass Herb Container, URL: <https://www.amazon.com/-/es/Recipiente-alimentos-especias-cannabis-almacenamiento/dp/B07SKF9VF3/ref=>

sr_1_1?mk_es_US=%C3%85M%C3%85%C5%BD%C3%95%C3%91&dchild=1&keywords=child%2Bresistant%2Bjar&qid=1609957280&sr=8-1&th=1 (Year: 2019).*

Primary Examiner — Brett Miller
Assistant Examiner — Rani J Abdallah

(57) **CLAIM**

The ornamental design for an tamper evident child resistant jar, as shown and described.

DESCRIPTION

FIG. 1 is a perspective view of an tamper evident child resistant jar showing my new design;
FIG. 2 is another perspective view thereof;
FIG. 3 is a front elevation view thereof;
FIG. 4 is a back elevation view thereof;
FIG. 5 is a left side view thereof;
FIG. 6 is a right side view thereof;
FIG. 7 is a top plan view thereof;
FIG. 8 is a bottom plan view thereof;
FIG. 9 is an open state diagram thereof;
FIG. 10 is another open state diagram thereof;
FIG. 11 is a perspective view of Component One;
FIG. 12 is a front elevation view of Component One;
FIG. 13 is a left side view of Component One;
FIG. 14 is a top plan view of Component One;
FIG. 15 is a bottom plan view of Component One;
FIG. 16 is a perspective view of Component Two;
FIG. 17 is a front elevation view of Component Two;
FIG. 18 is a top plan view of Component Two;
FIG. 19 is a bottom plan view of Component Two;
FIG. 20 is a perspective view of Component Three;
FIG. 21 is a front elevation view of Component Three;
FIG. 22 is a back elevation view of Component Three;
FIG. 23 is a left side view of Component Three;
FIG. 24 is a right side view of Component Three;
FIG. 25 is a top plan view of Component Three; and,
FIG. 26 is a bottom plan view of Component Three.
A back elevation view and a right side view of Component 1 are omitted due to the same with a front elevation view and a left side view of Component 1, respectively.

(Continued)

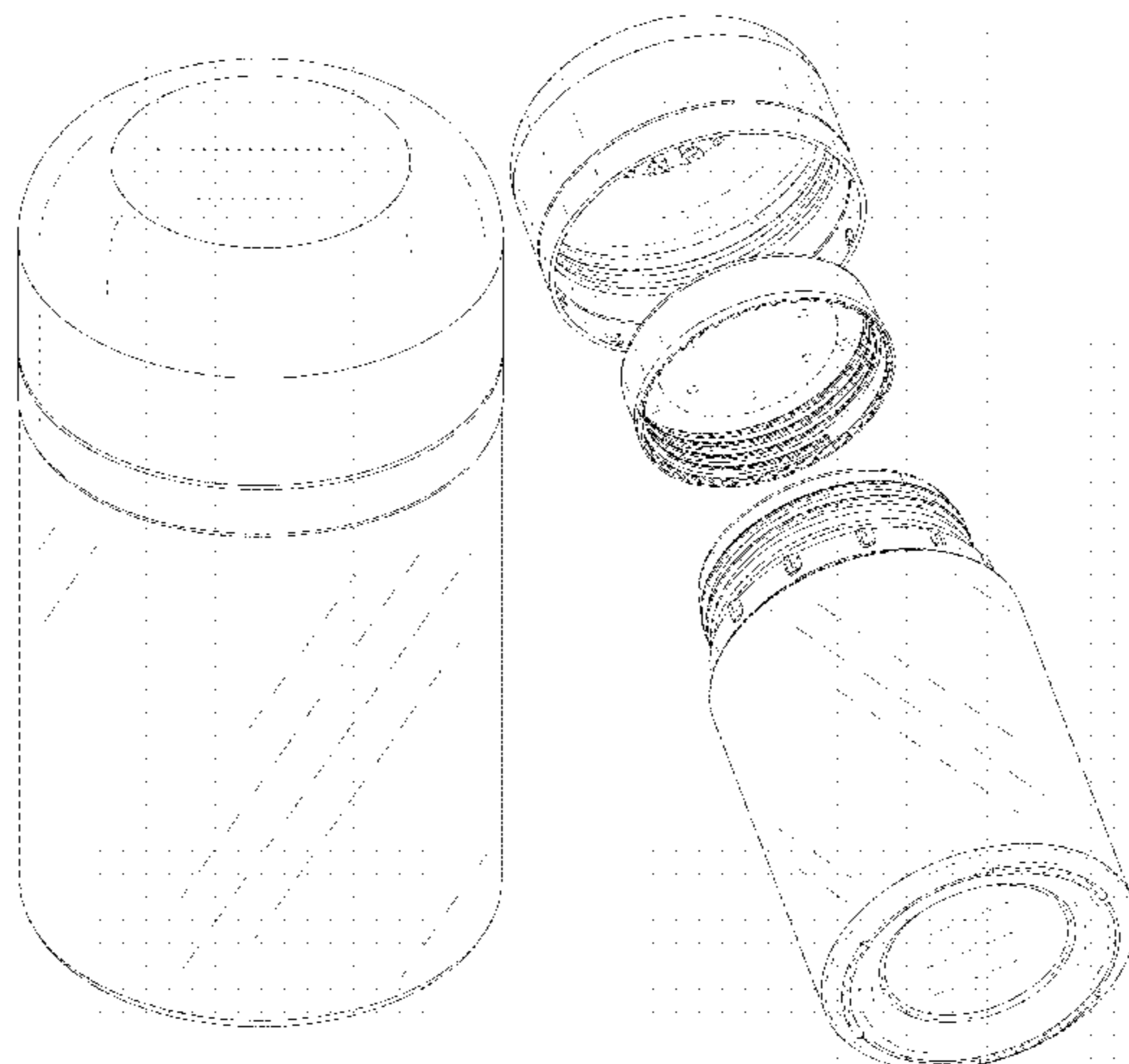

A back elevation view, a left side view and a left right side view of Component 2 are omitted due to the same with a front elevation view of Component 2.
The broken lines in the figures illustrate the portions of the design that form no part of the claimed design.

1 Claim, 26 Drawing Sheets

(58) **Field of Classification Search**

USPC D9/767, 772; D28/4, 8, 76, 78, 79, 82,
D28/91; D26/6, 22; D7/316, 598, 603,
D7/629, 597, 608
CPC B65D 7/04; B65D 1/165; B65D 45/24;
B65D 1/0246; B65D 1/0207; Y10S
220/906; B21D 51/2615; A47G 19/2255
See application file for complete search history.

(56) **References Cited**

U.S. PATENT DOCUMENTS

D280,975 S * 10/1985 Van Dine D9/504
5,052,592 A * 10/1991 Wilken B65D 83/0033
222/212

D322,753 S * 12/1991 Sussman D9/504
5,115,929 A * 5/1992 Buono B65D 50/041
215/216
5,611,443 A * 3/1997 King B65D 50/041
215/220
D466,814 S * 12/2002 Hurlburt D9/504
D485,017 S * 1/2004 Noh D28/76
D503,829 S * 4/2005 Tanii D28/76
D503,830 S * 4/2005 Tanii D28/76
D612,240 S * 3/2010 Cresswell D9/504
D623,475 S * 9/2010 Aarnoudse D9/504
D642,918 S * 8/2011 Taylor D9/454
D642,919 S * 8/2011 Taylor D9/454
D661,192 S * 6/2012 Hwang D9/504
D693,688 S * 11/2013 Russell D9/504
D737,149 S * 8/2015 Son D9/688
D739,740 S * 9/2015 Sturdevant D9/504
D765,512 S * 9/2016 Joulia D9/504
D786,679 S * 5/2017 Barroso Miana D9/504
D828,113 S * 9/2018 Fleischhut D7/608
D828,162 S * 9/2018 Windelinckx D9/500
D871,844 S * 1/2020 Adams, Jr. D9/504
D903,496 S * 12/2020 Burrowes D9/504
2008/0302756 A1 * 12/2008 Phillips B65D 7/04
215/329
2020/0015609 A1 * 1/2020 Rhodes A47G 19/2205

* cited by examiner

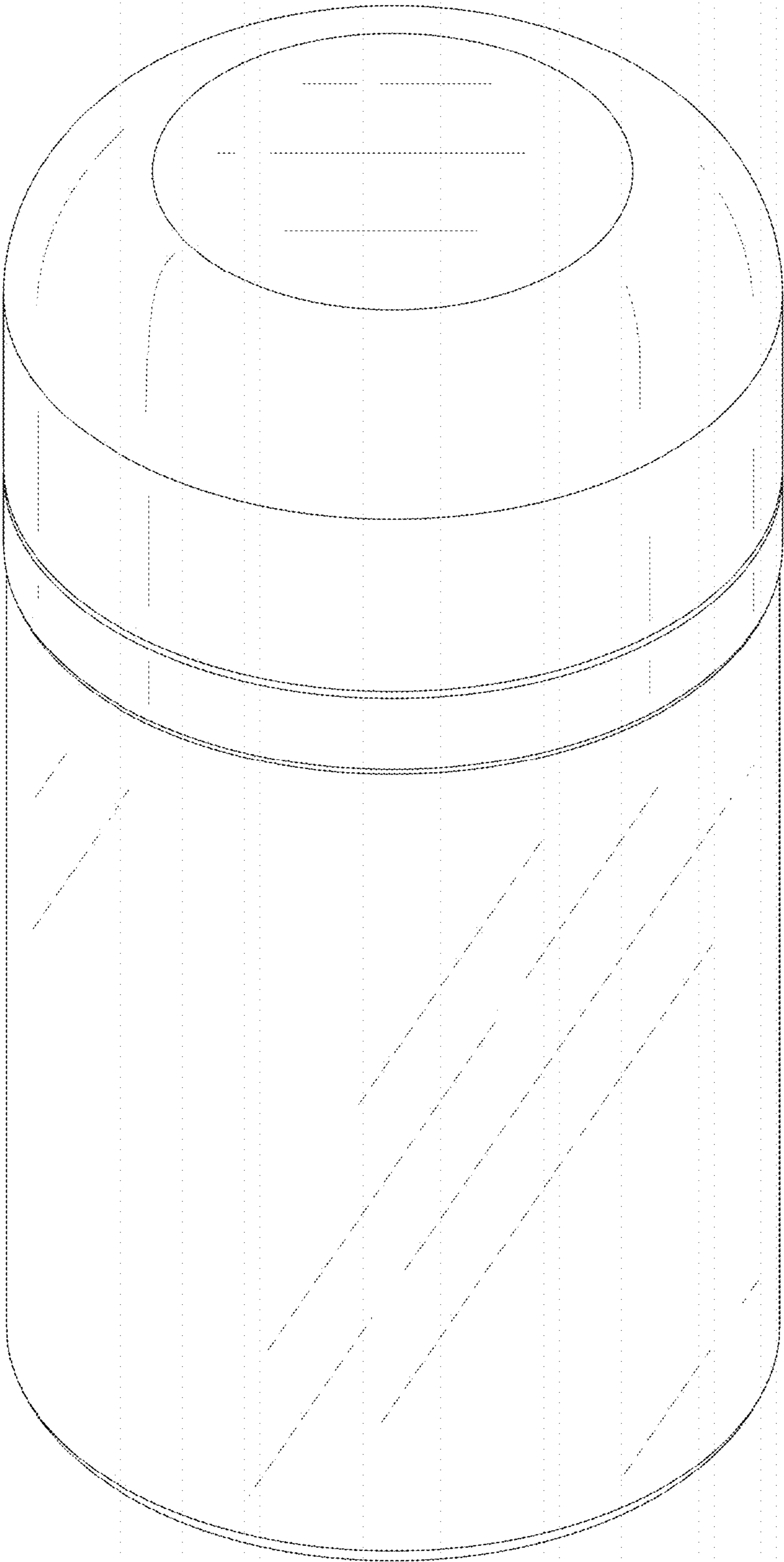

FIG. 1

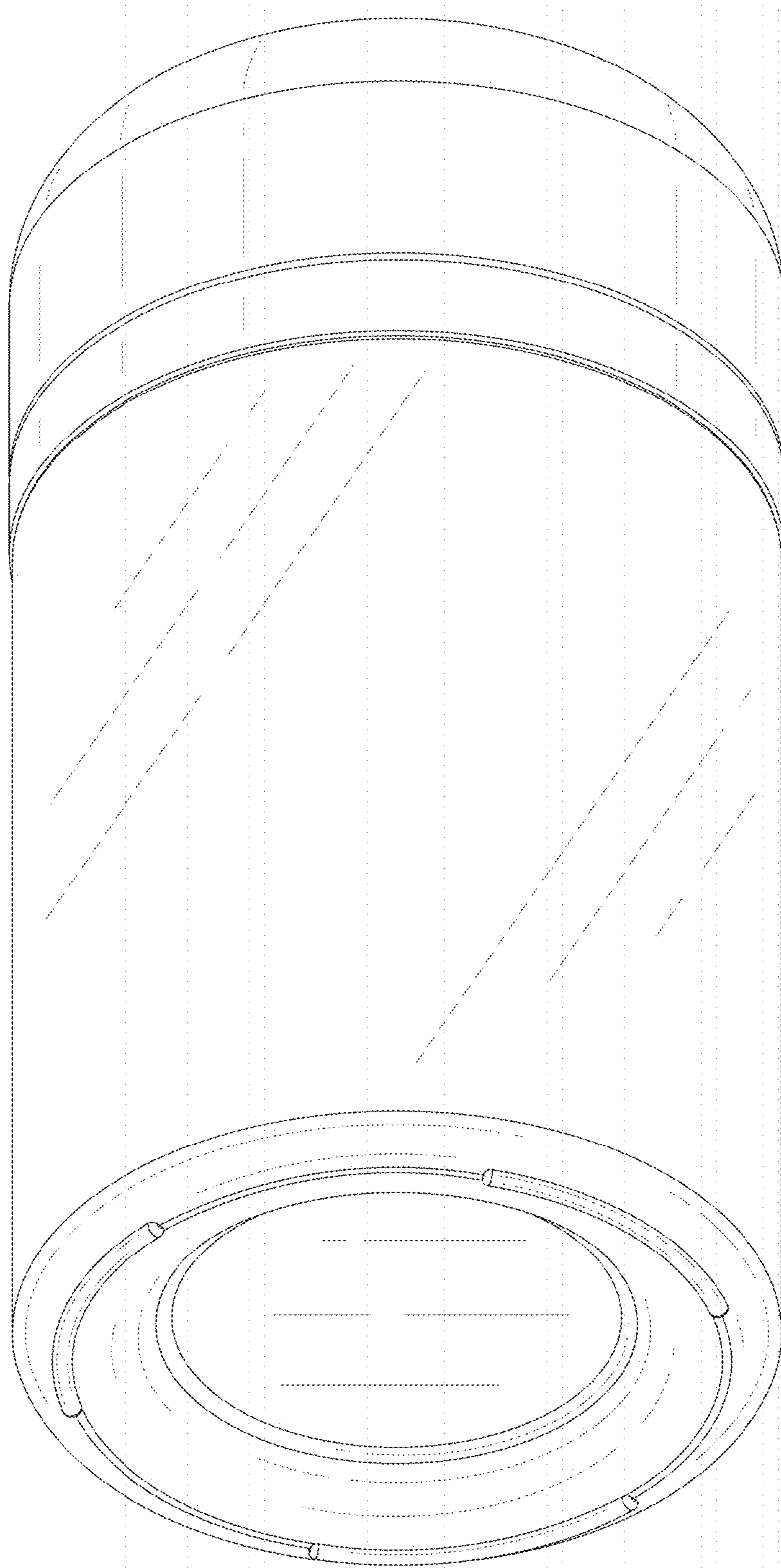

FIG. 2

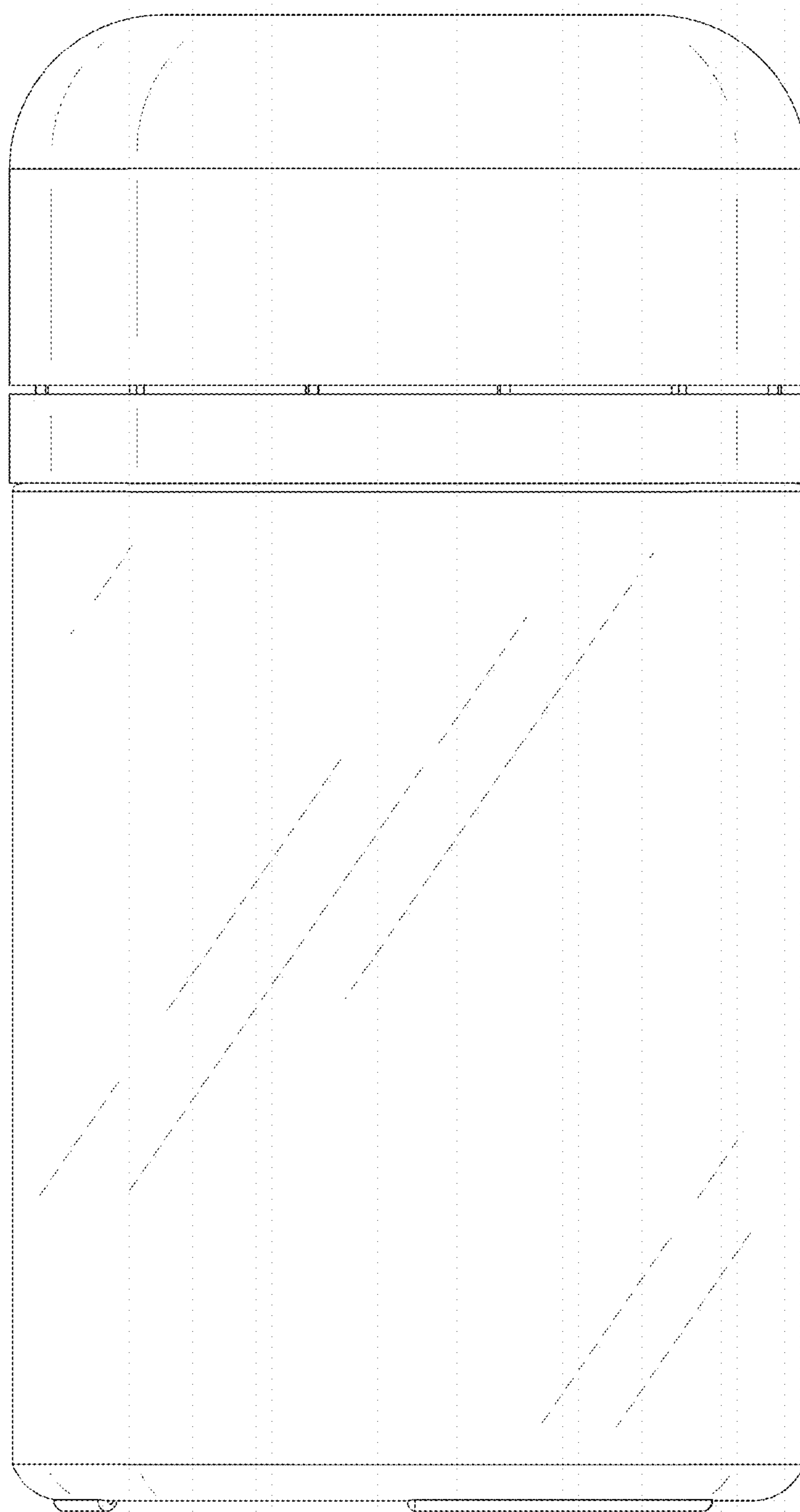

FIG. 3

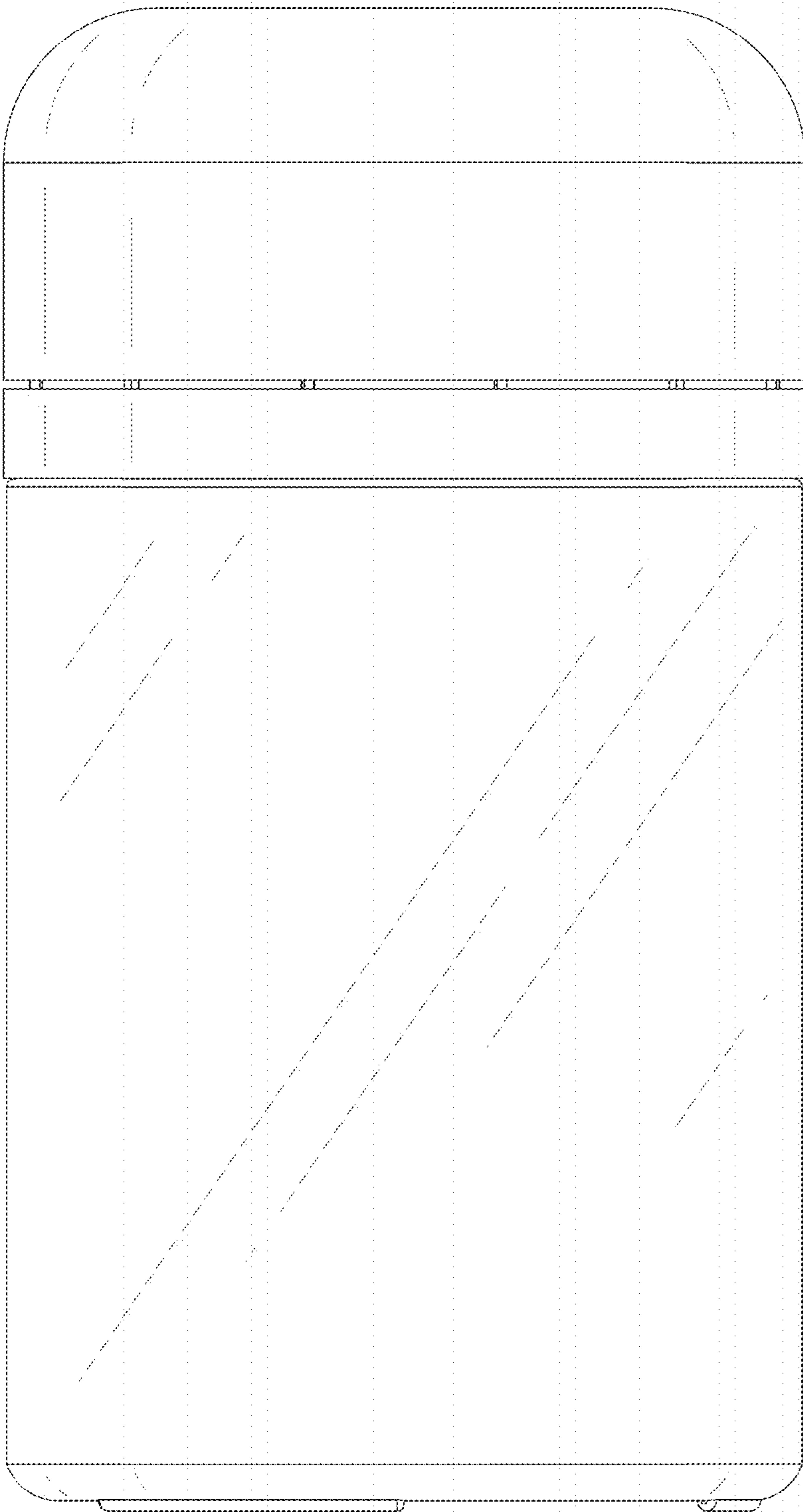

FIG. 4

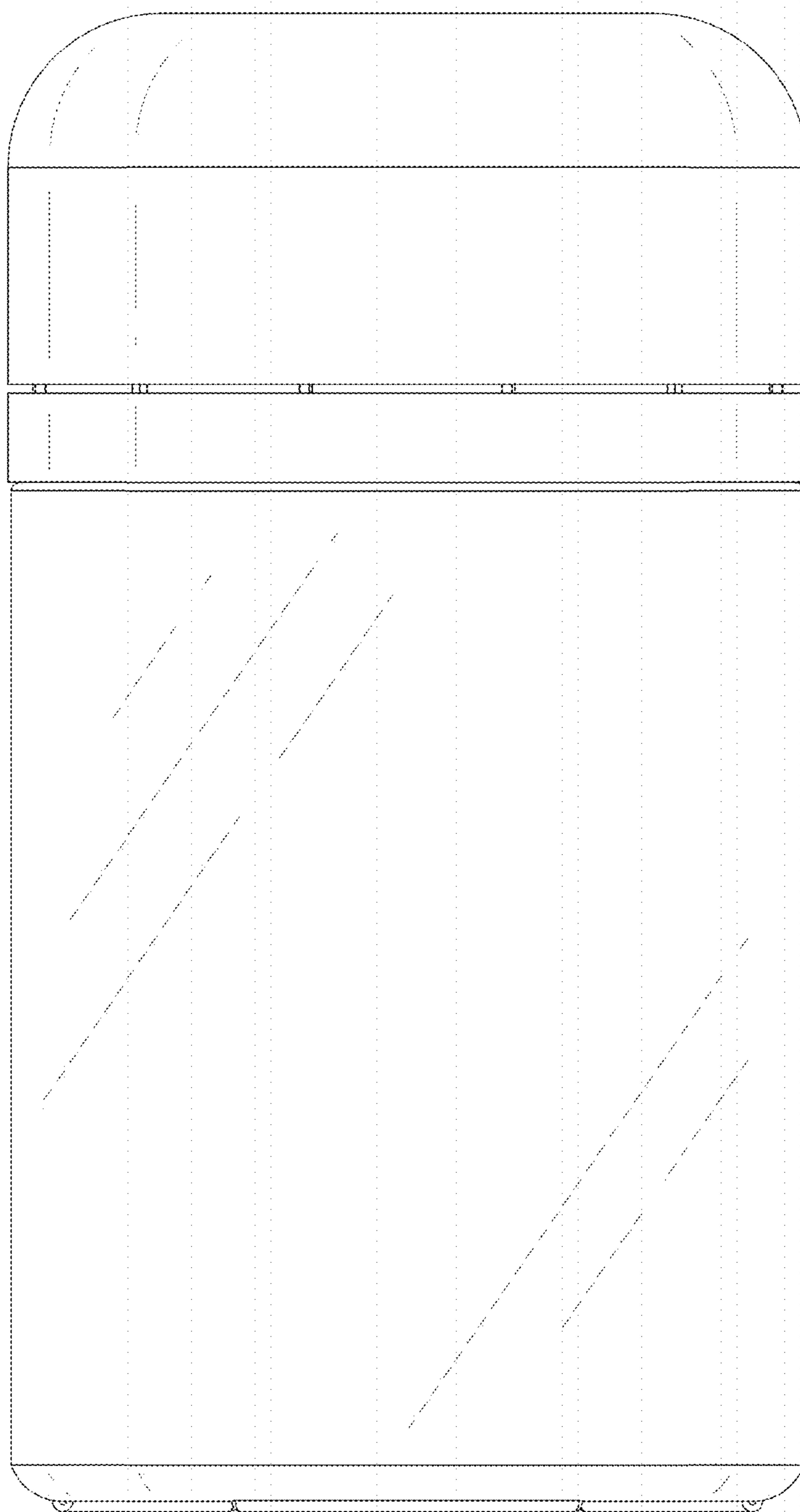

FIG. 5

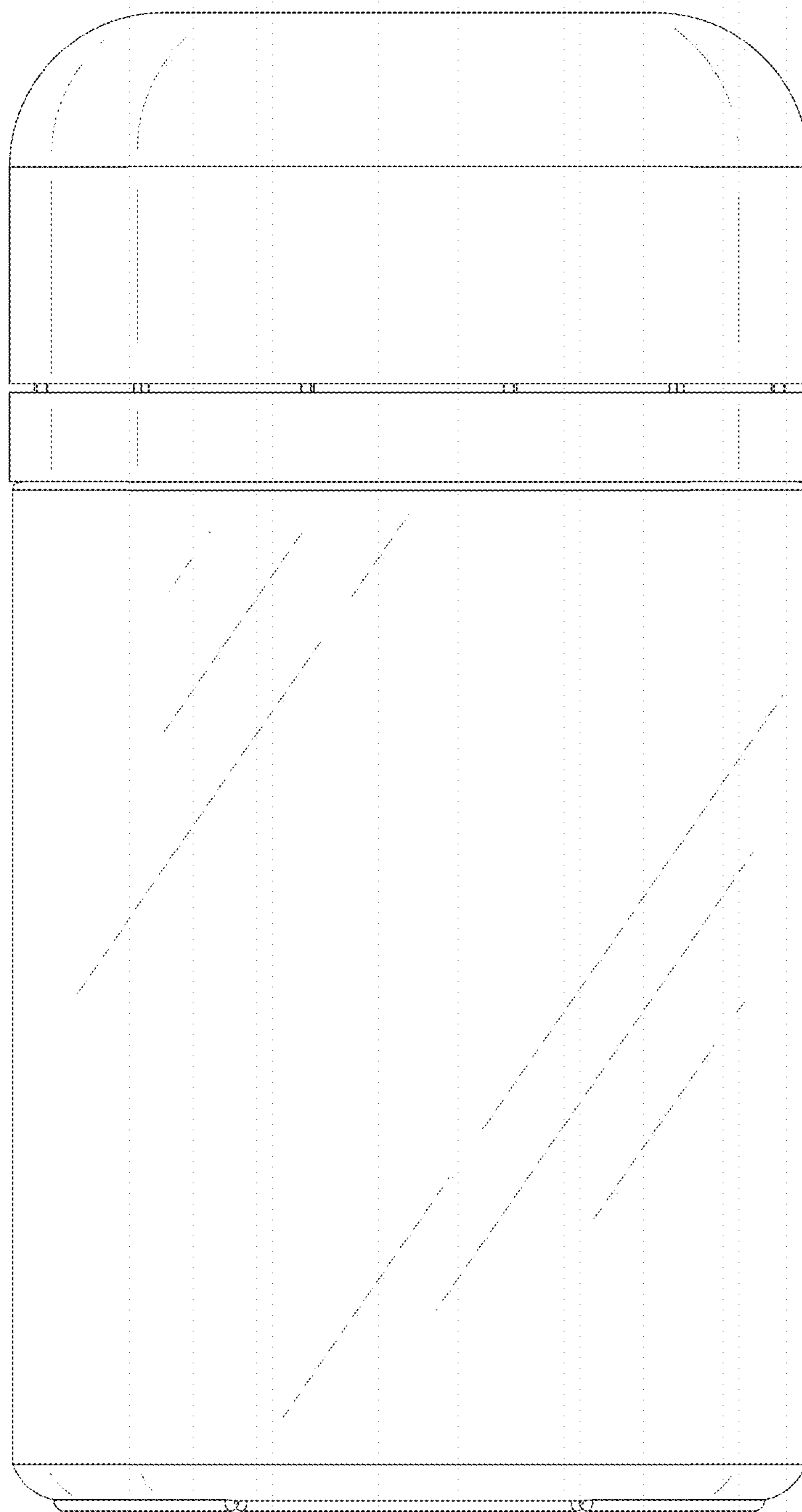

FIG. 6

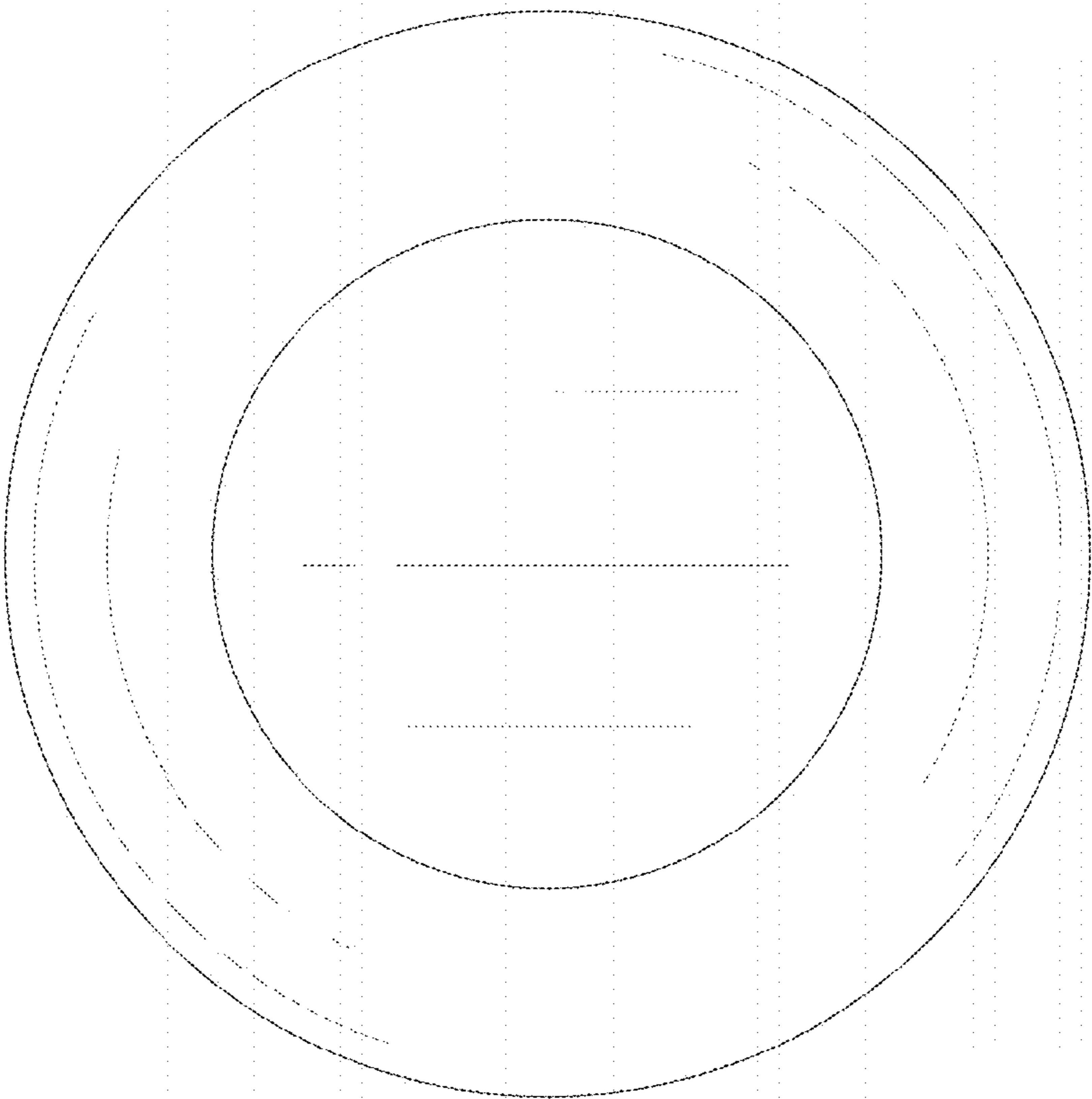

FIG. 7

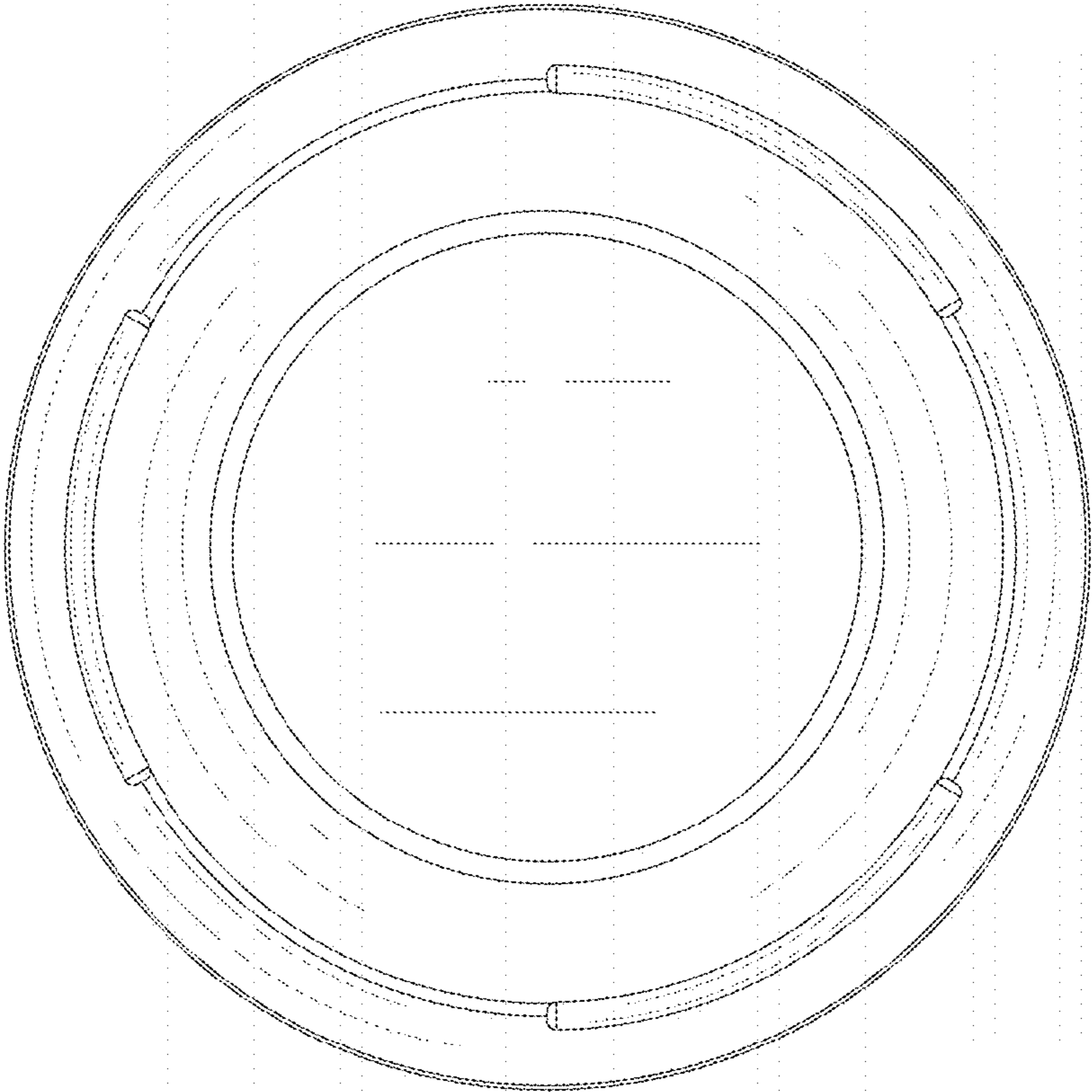

FIG. 8

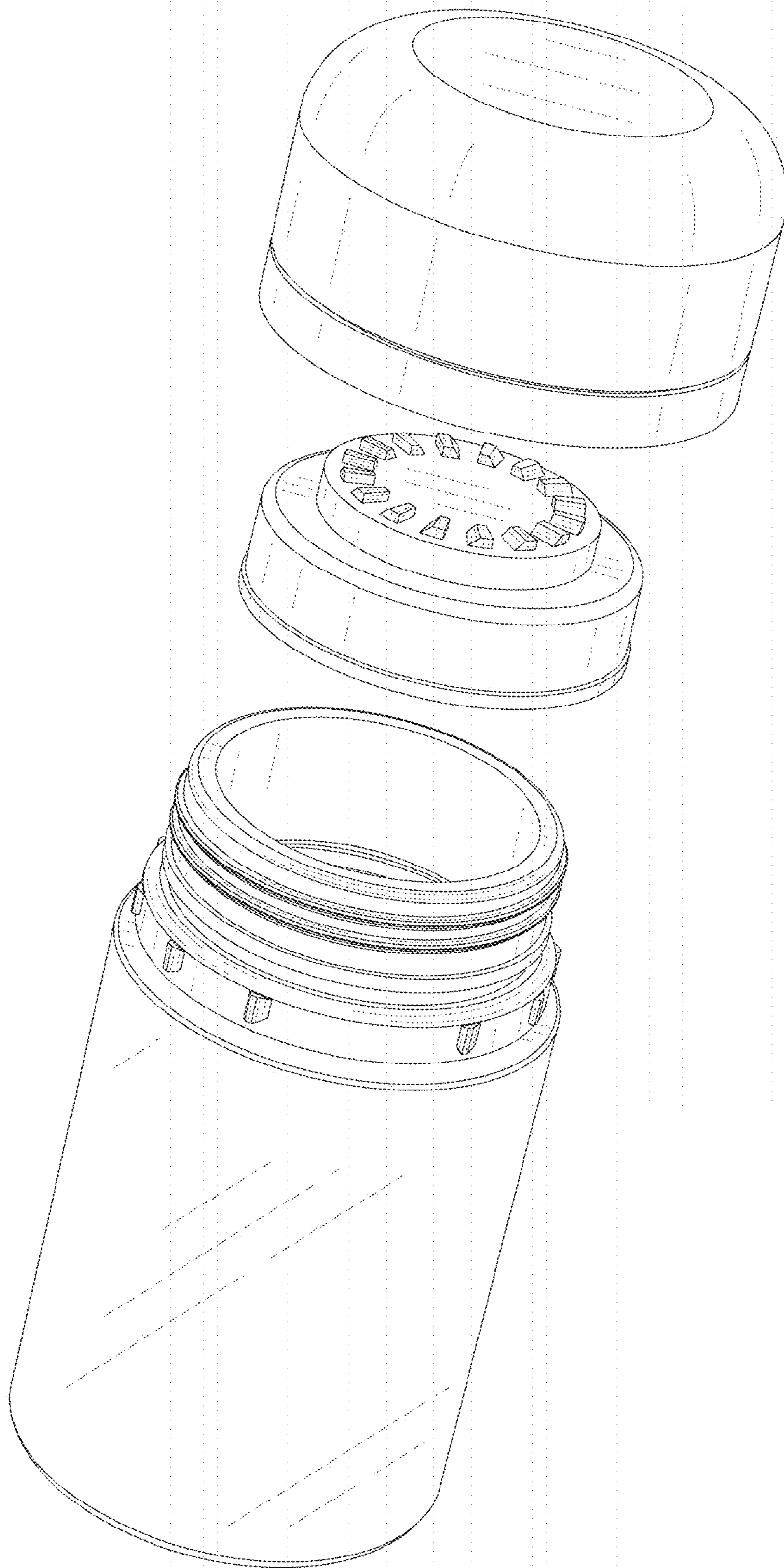

FIG. 9

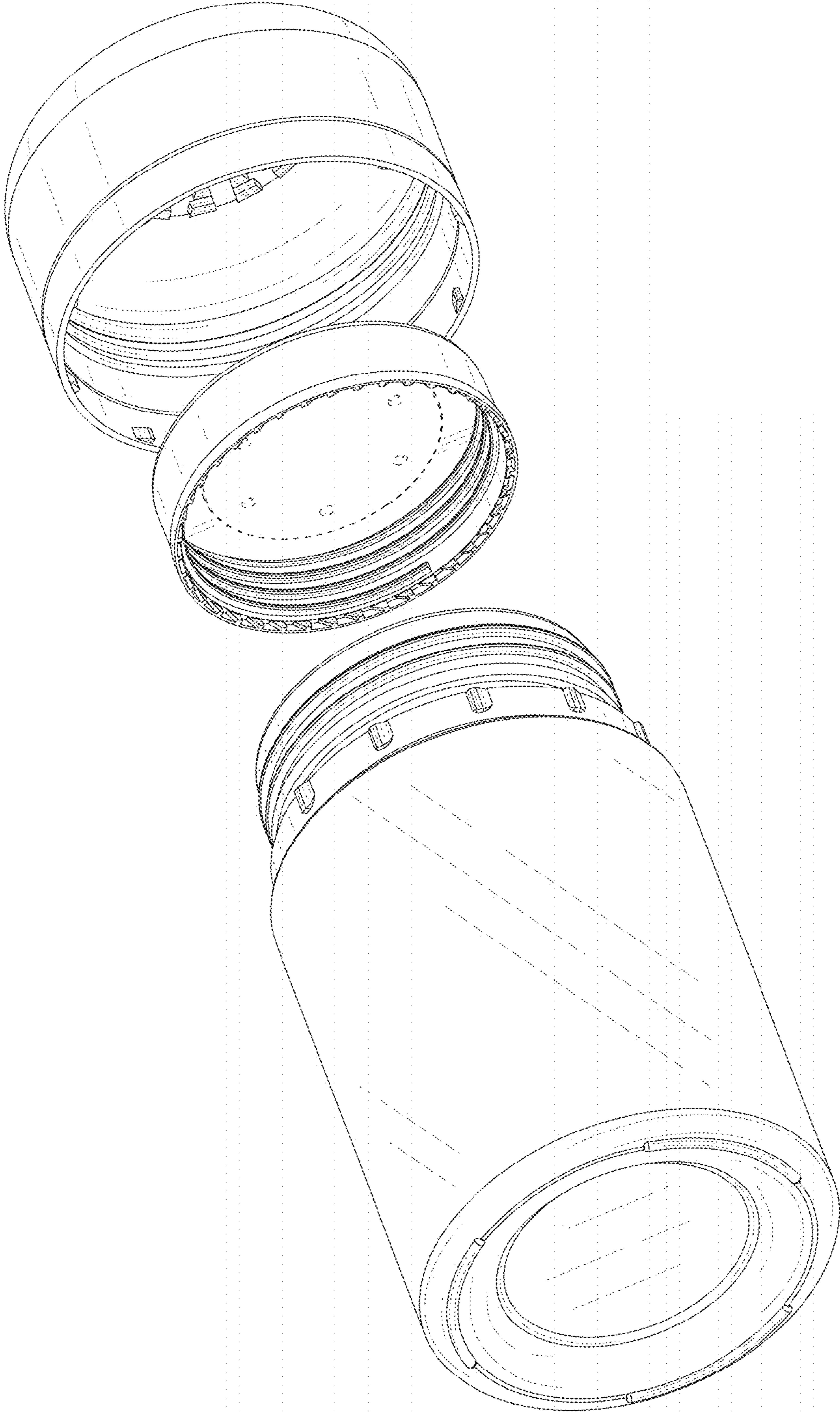

FIG. 10

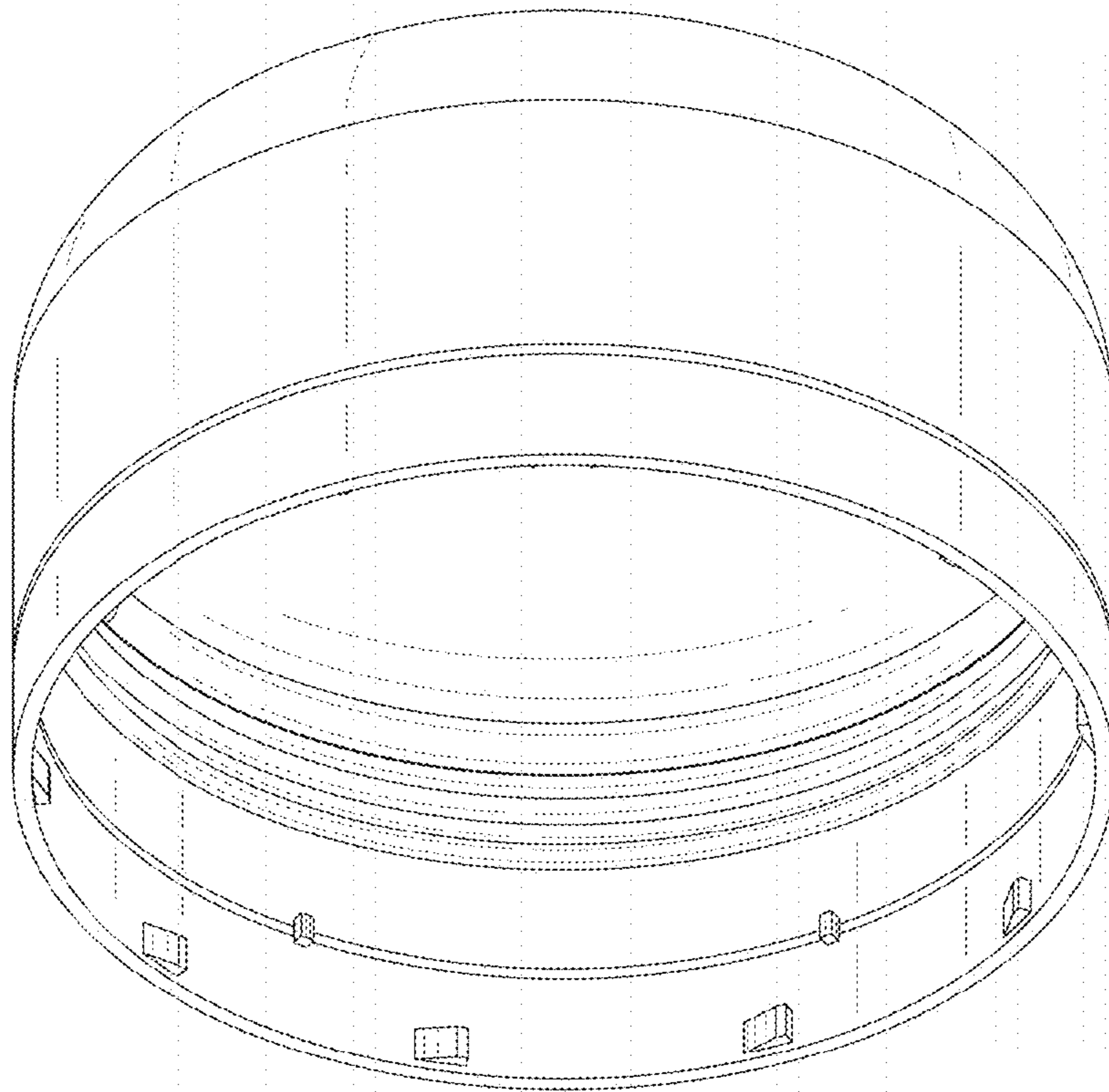

FIG. 11

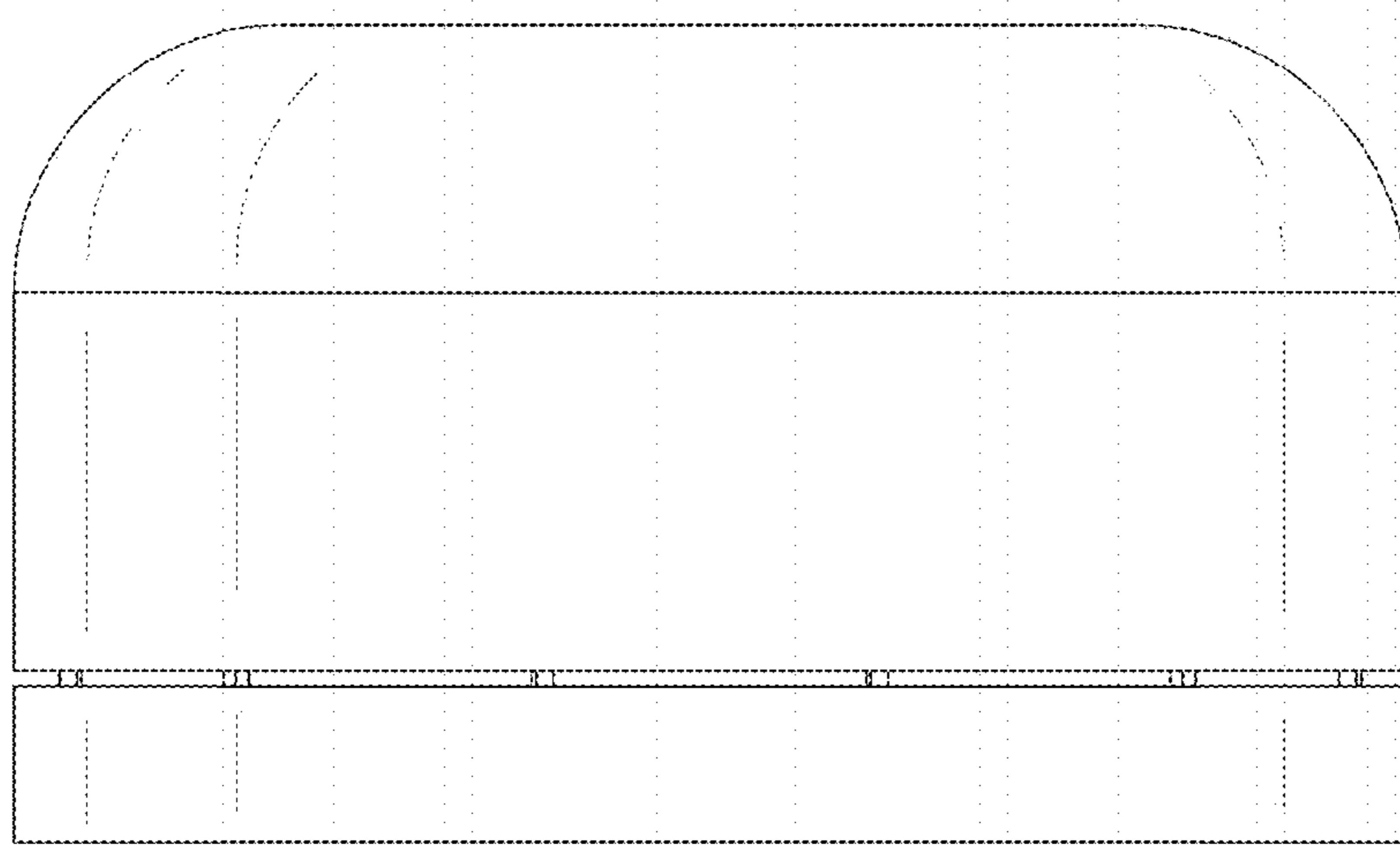

FIG. 12

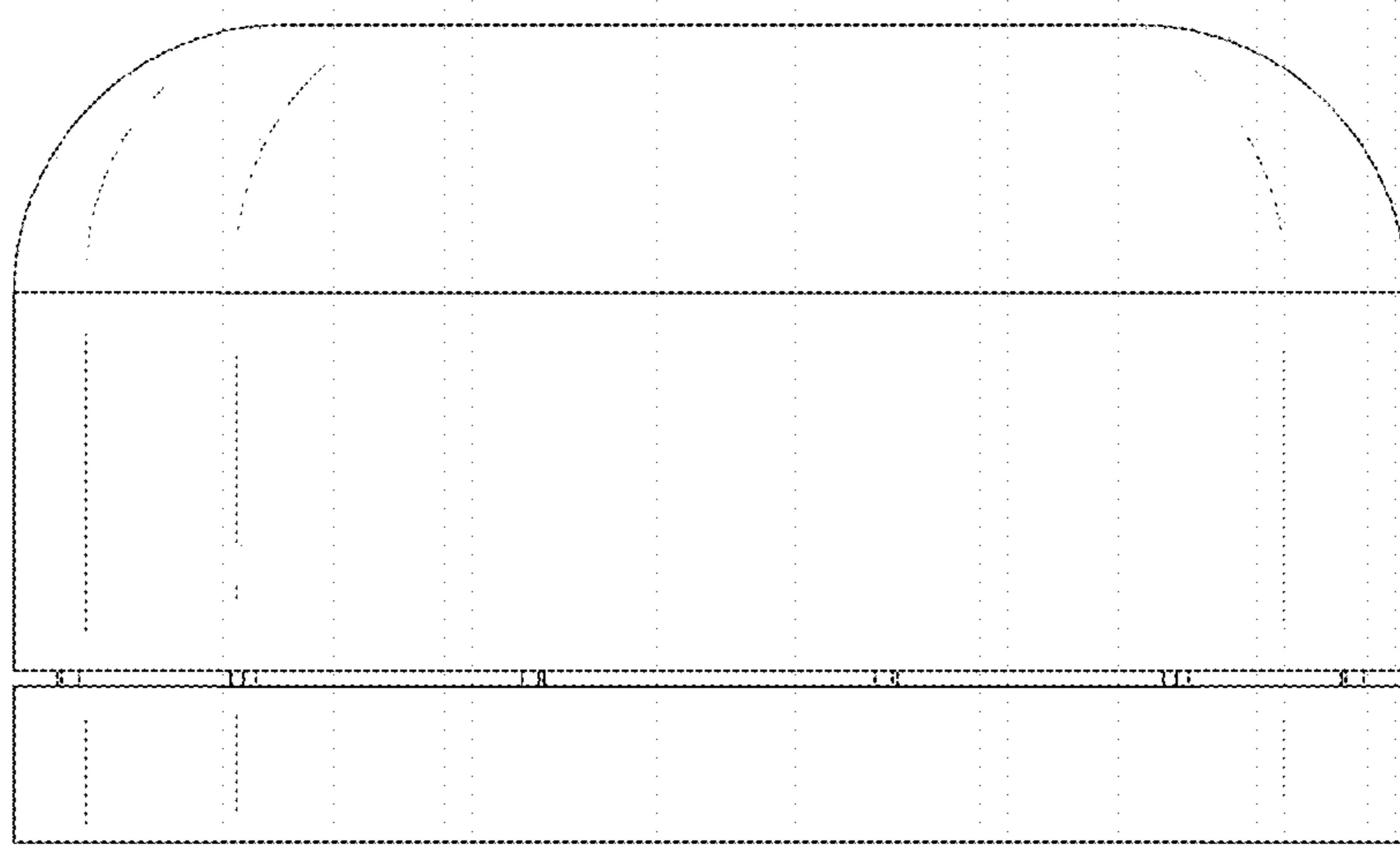

FIG. 13

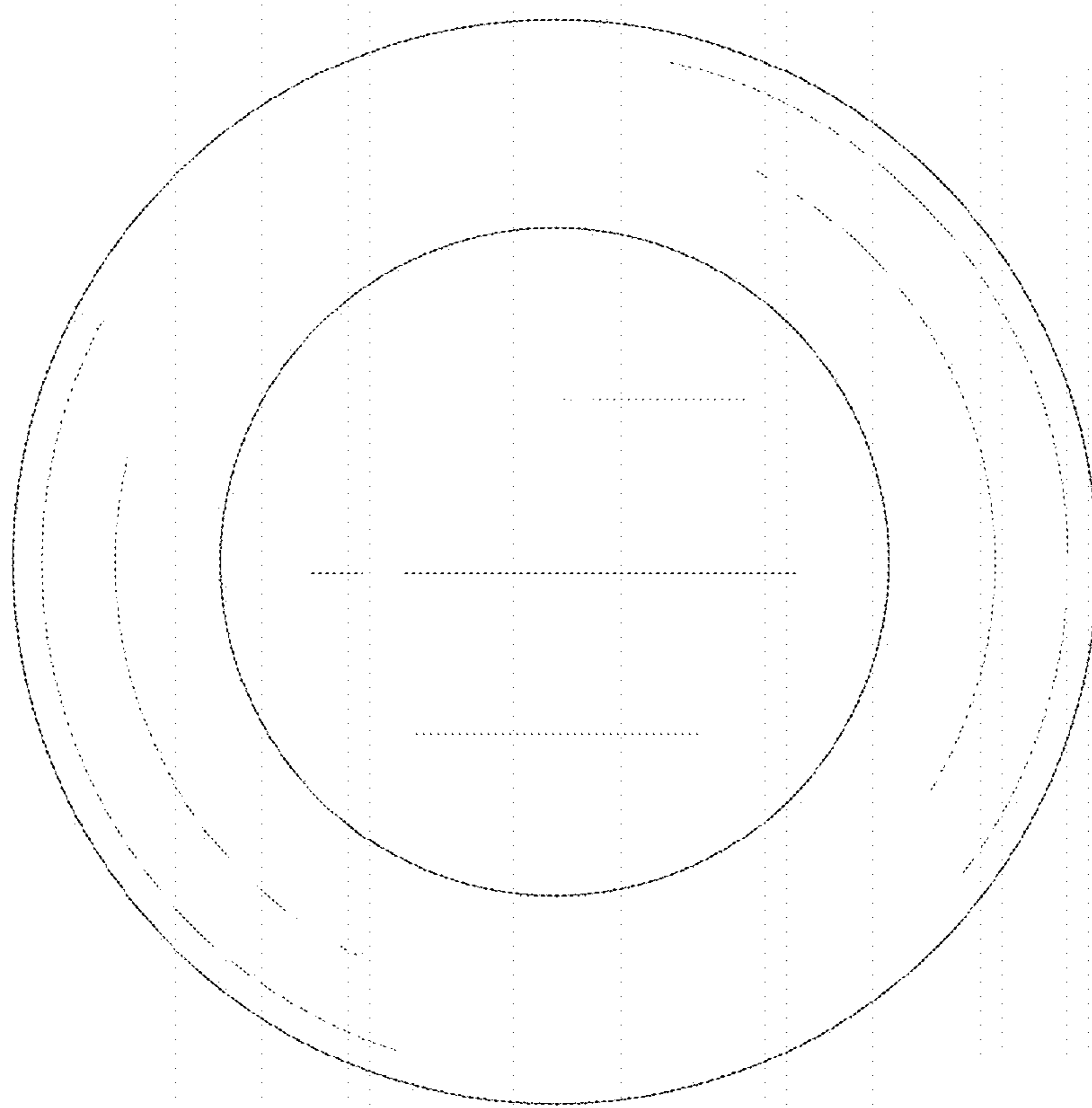

FIG. 14

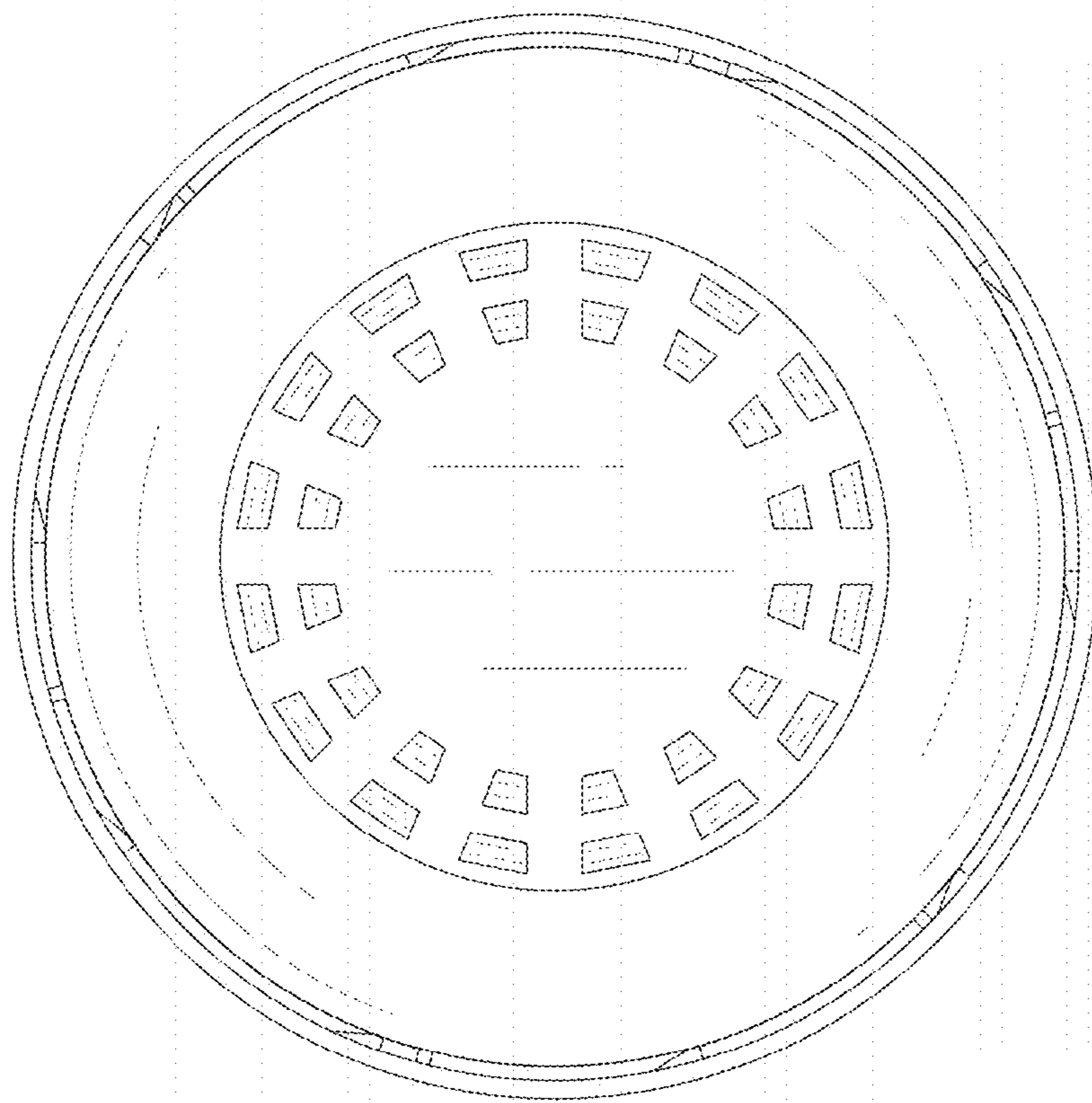

FIG. 15

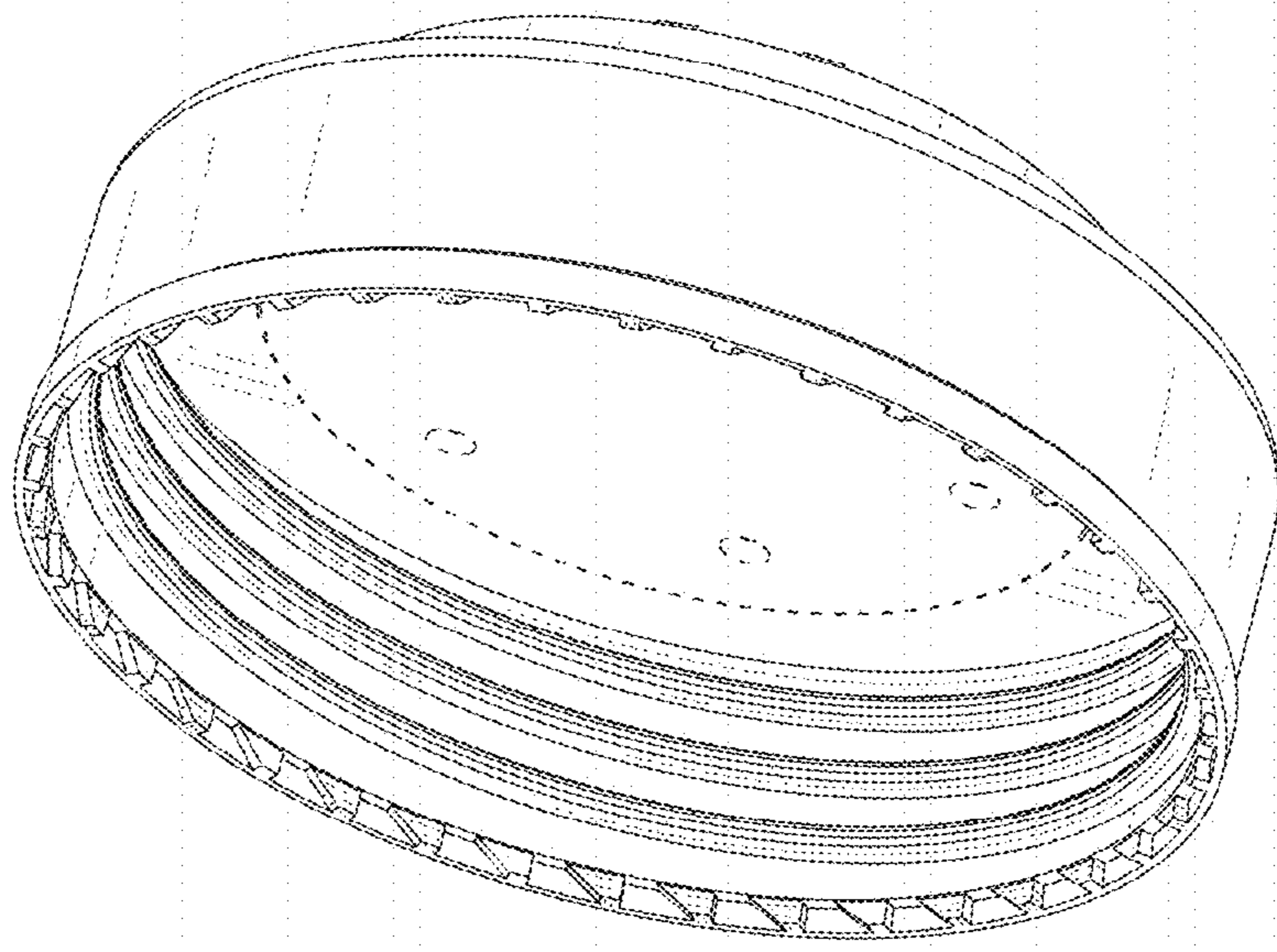

FIG. 16

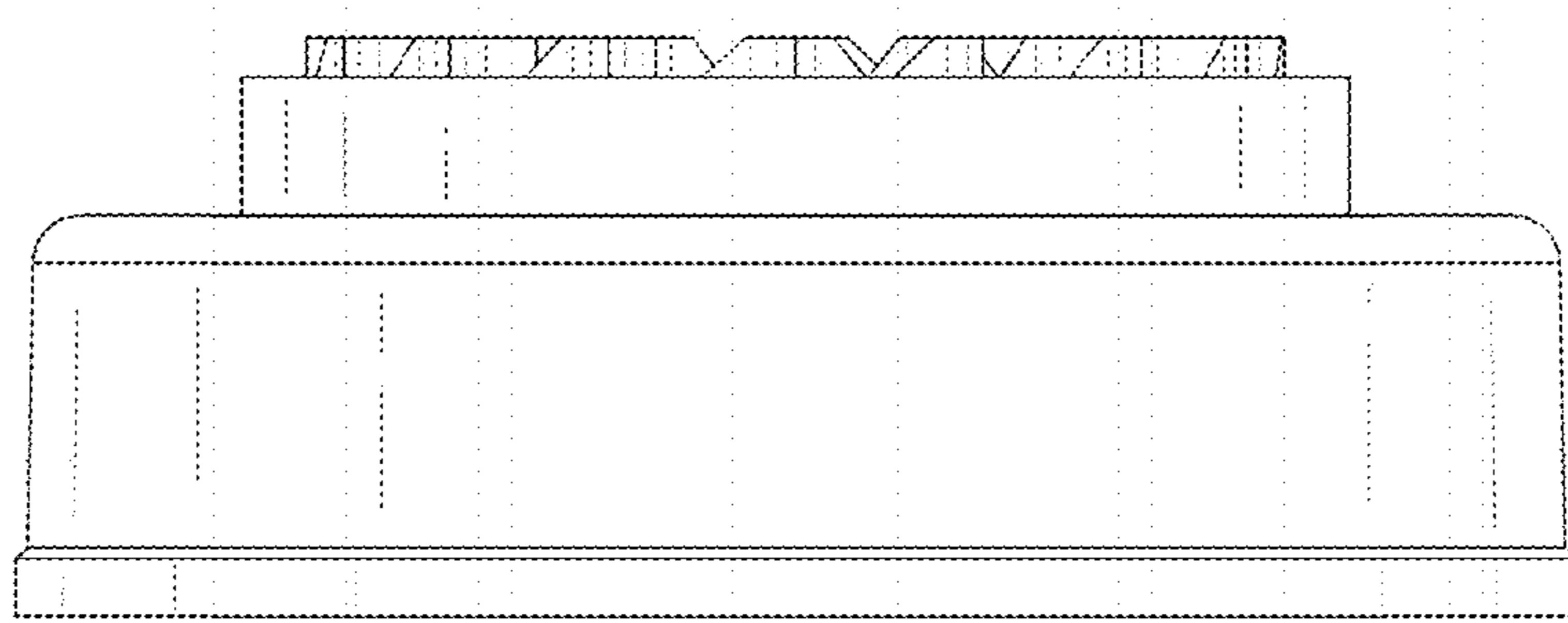

FIG. 17

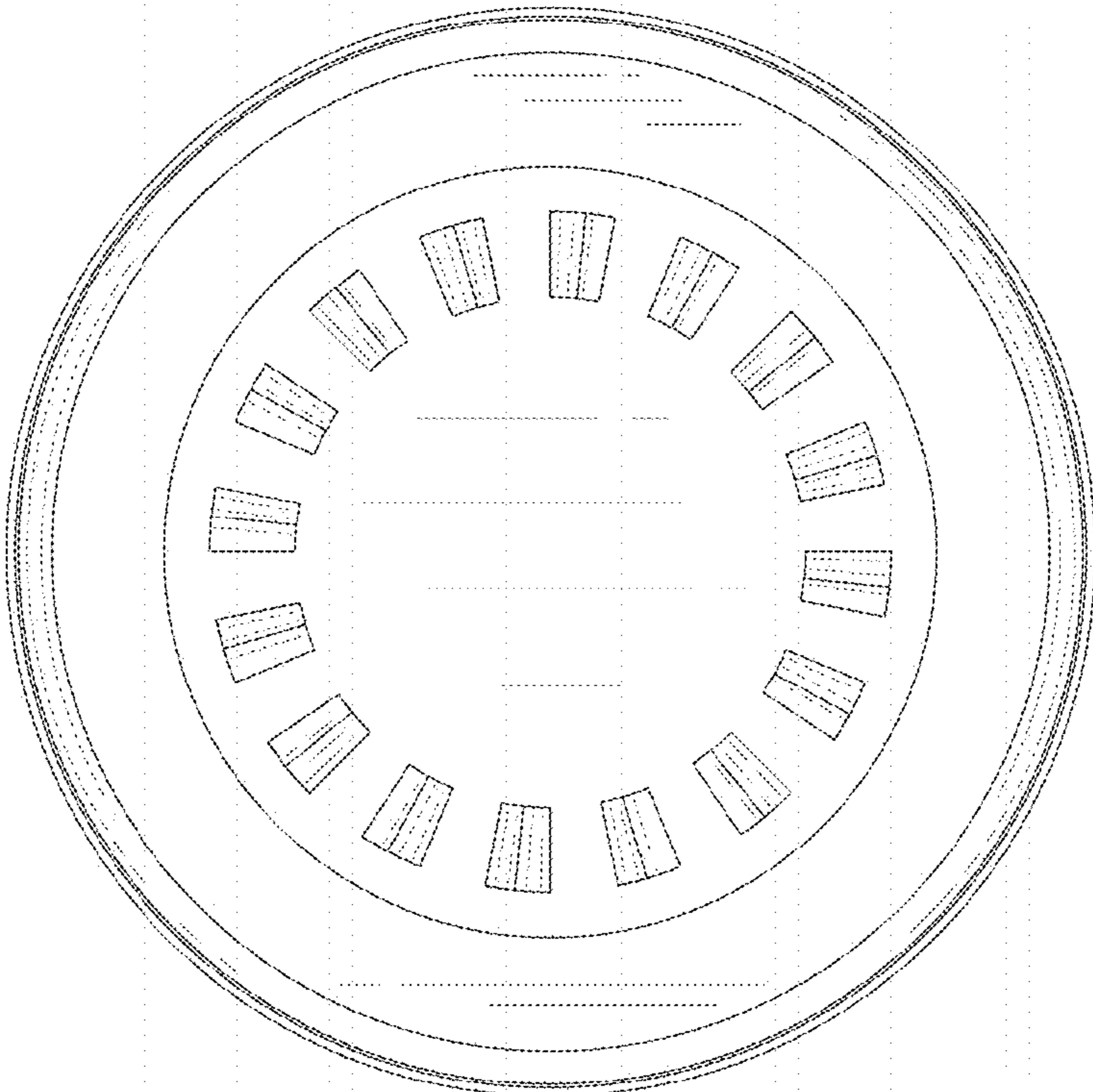

FIG. 18

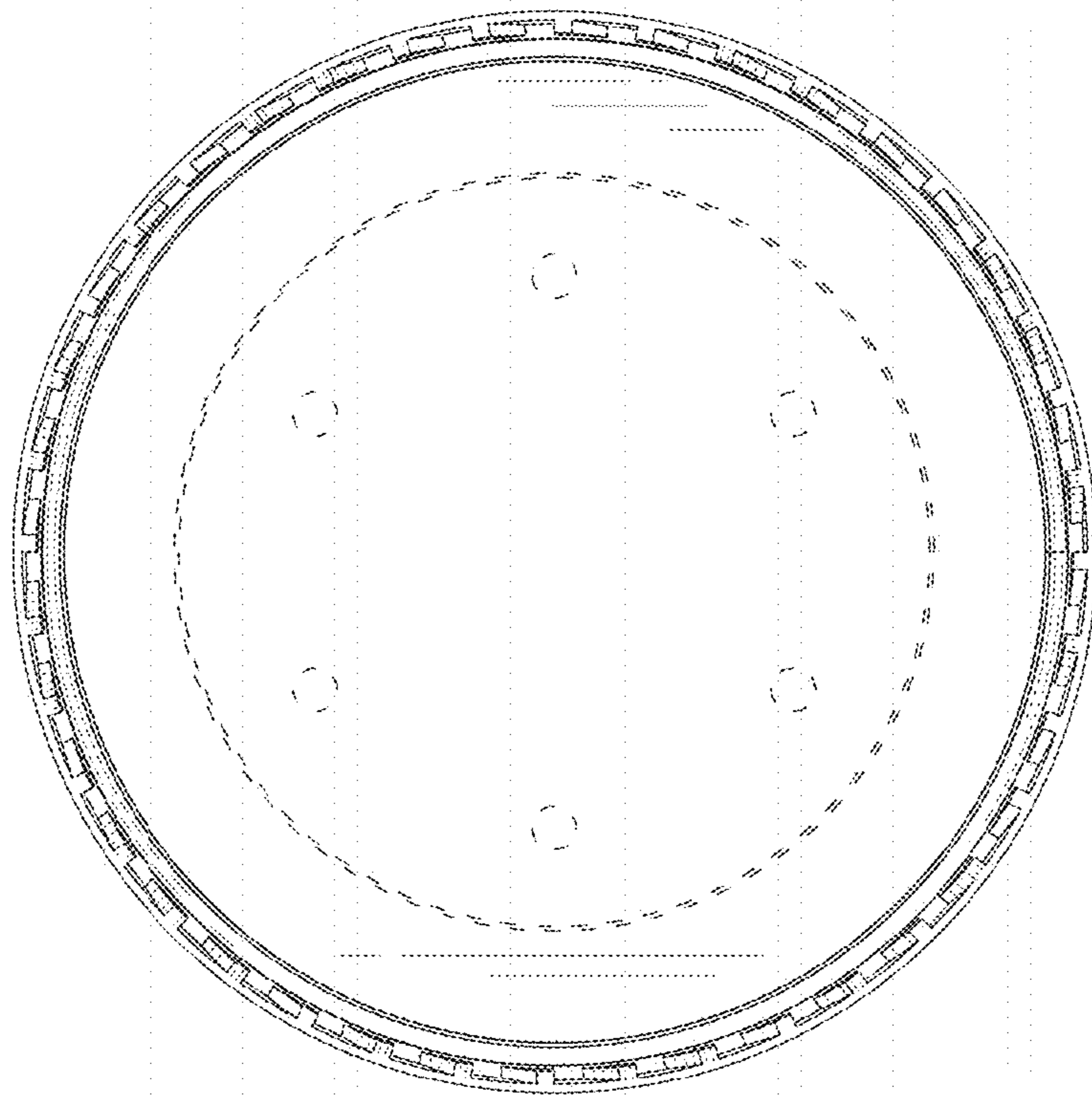

FIG. 19

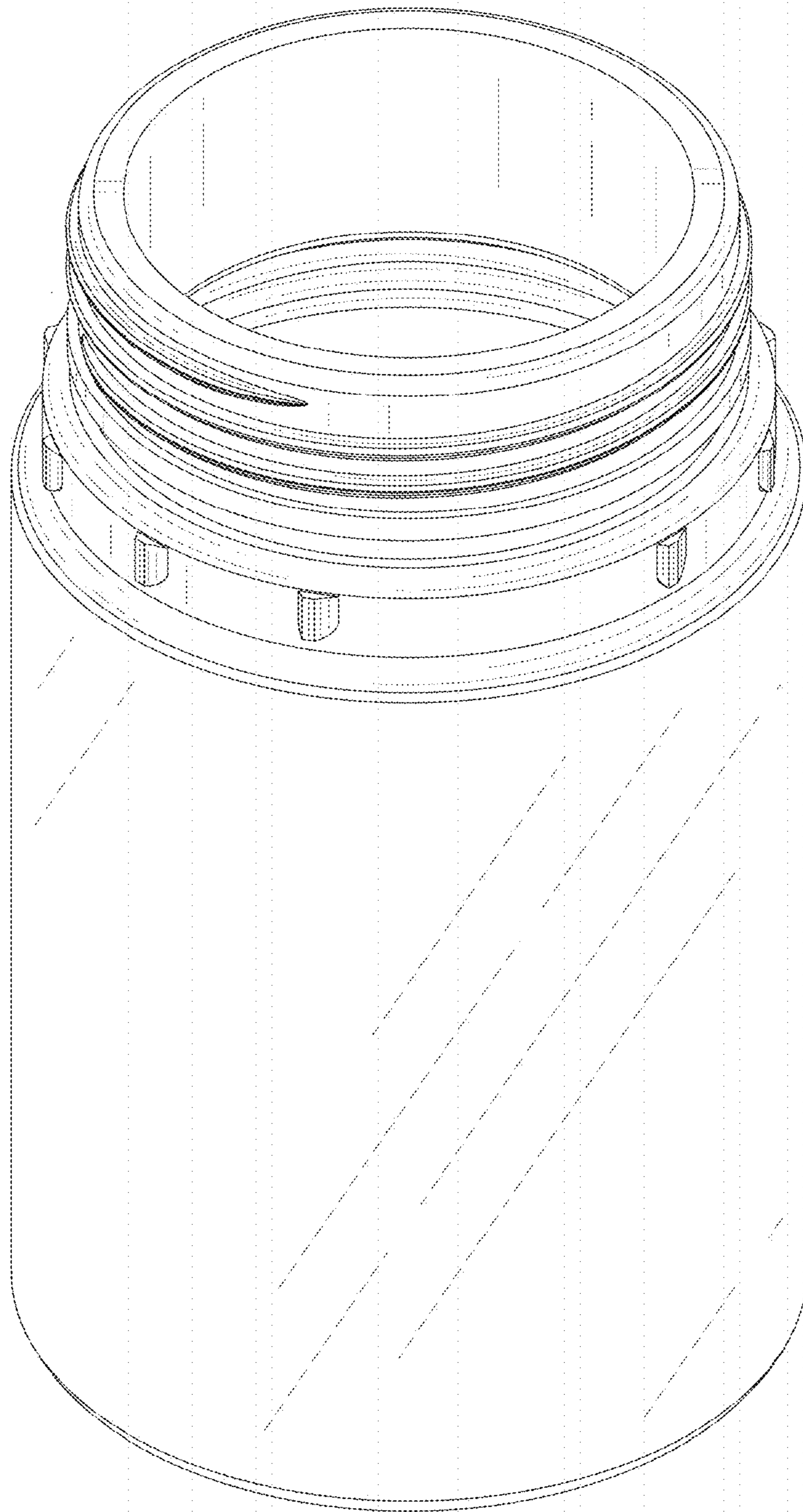

FIG. 20

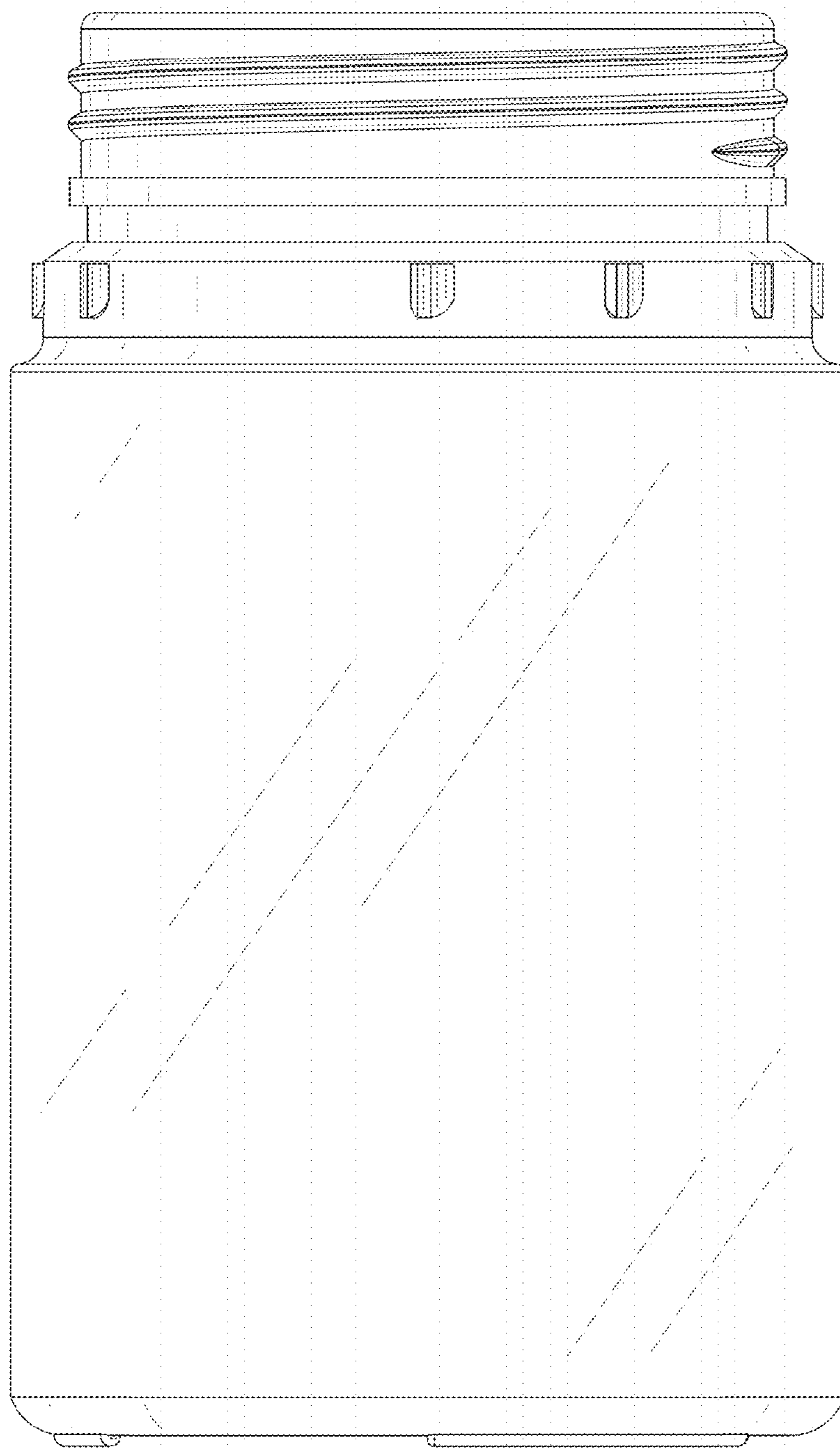

FIG. 21

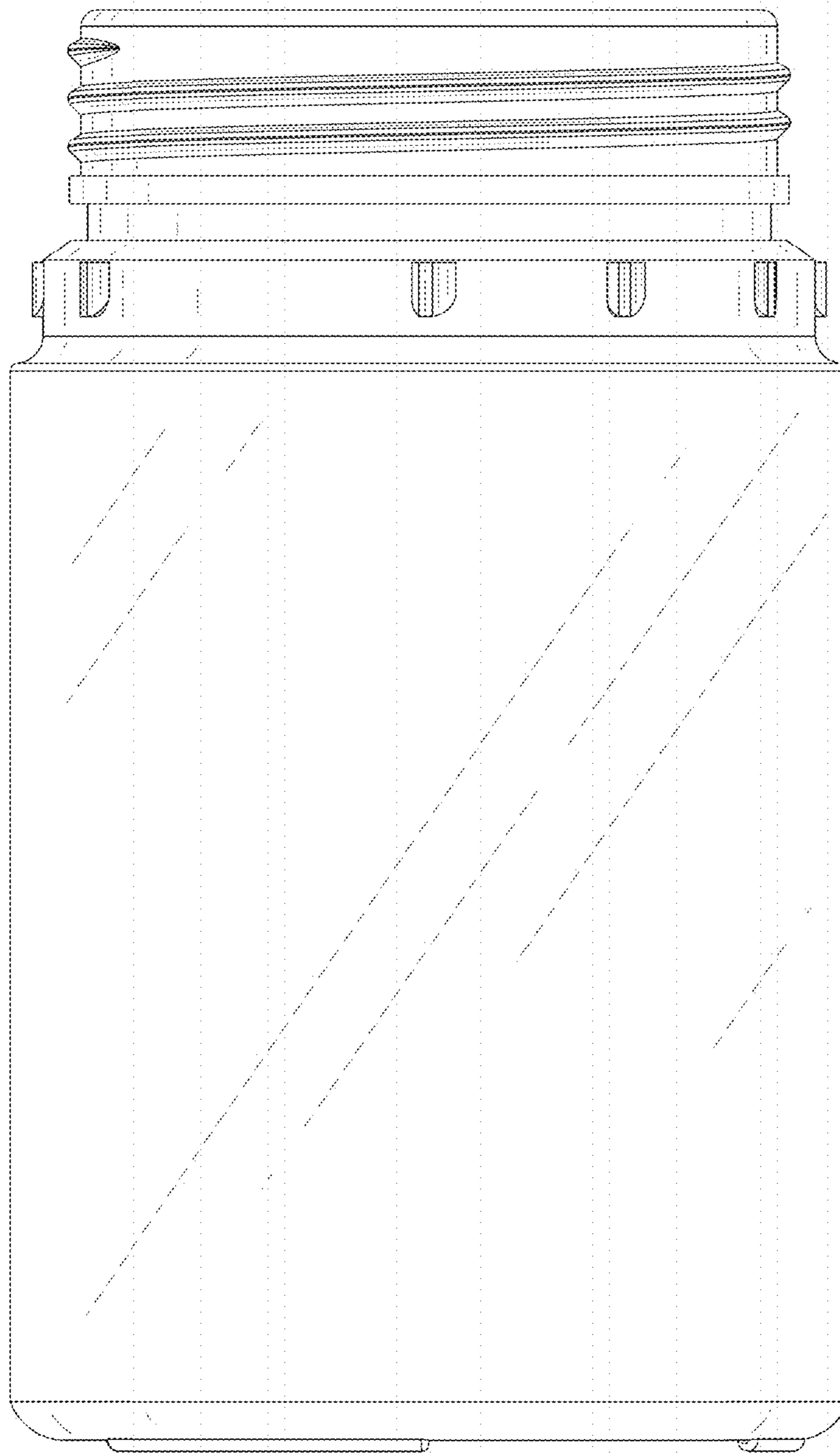

FIG. 22

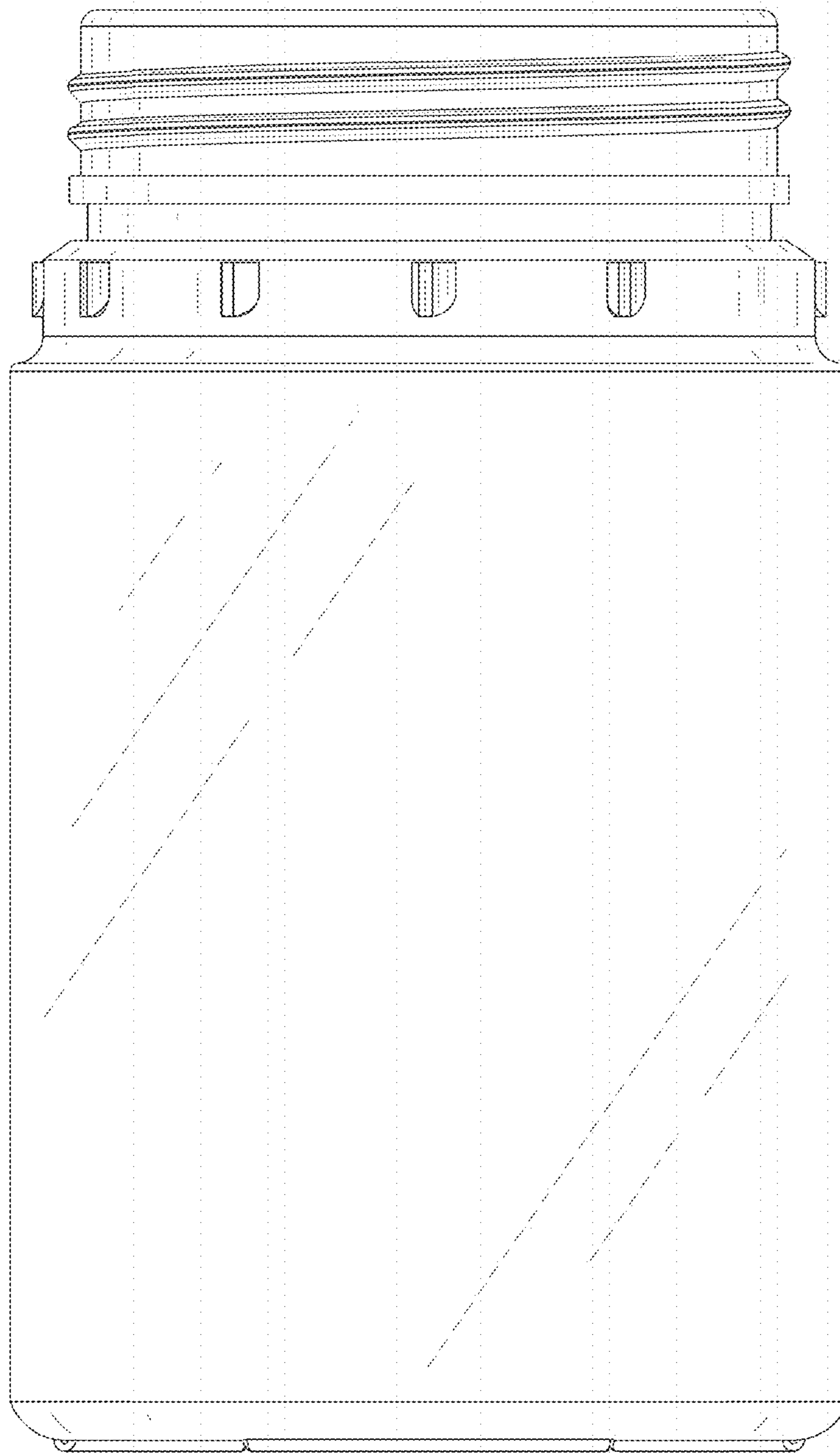

FIG. 23

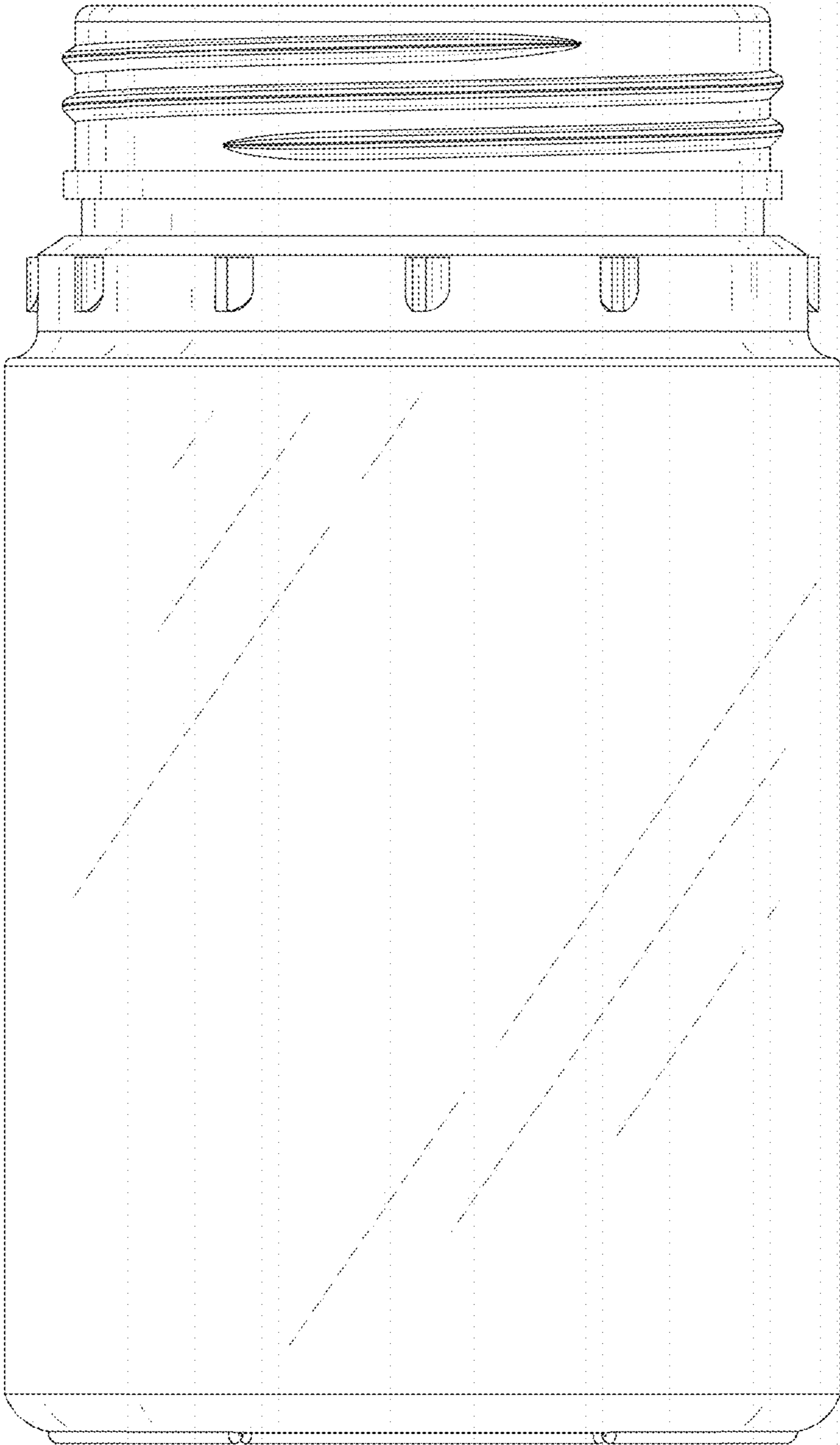

FIG. 24

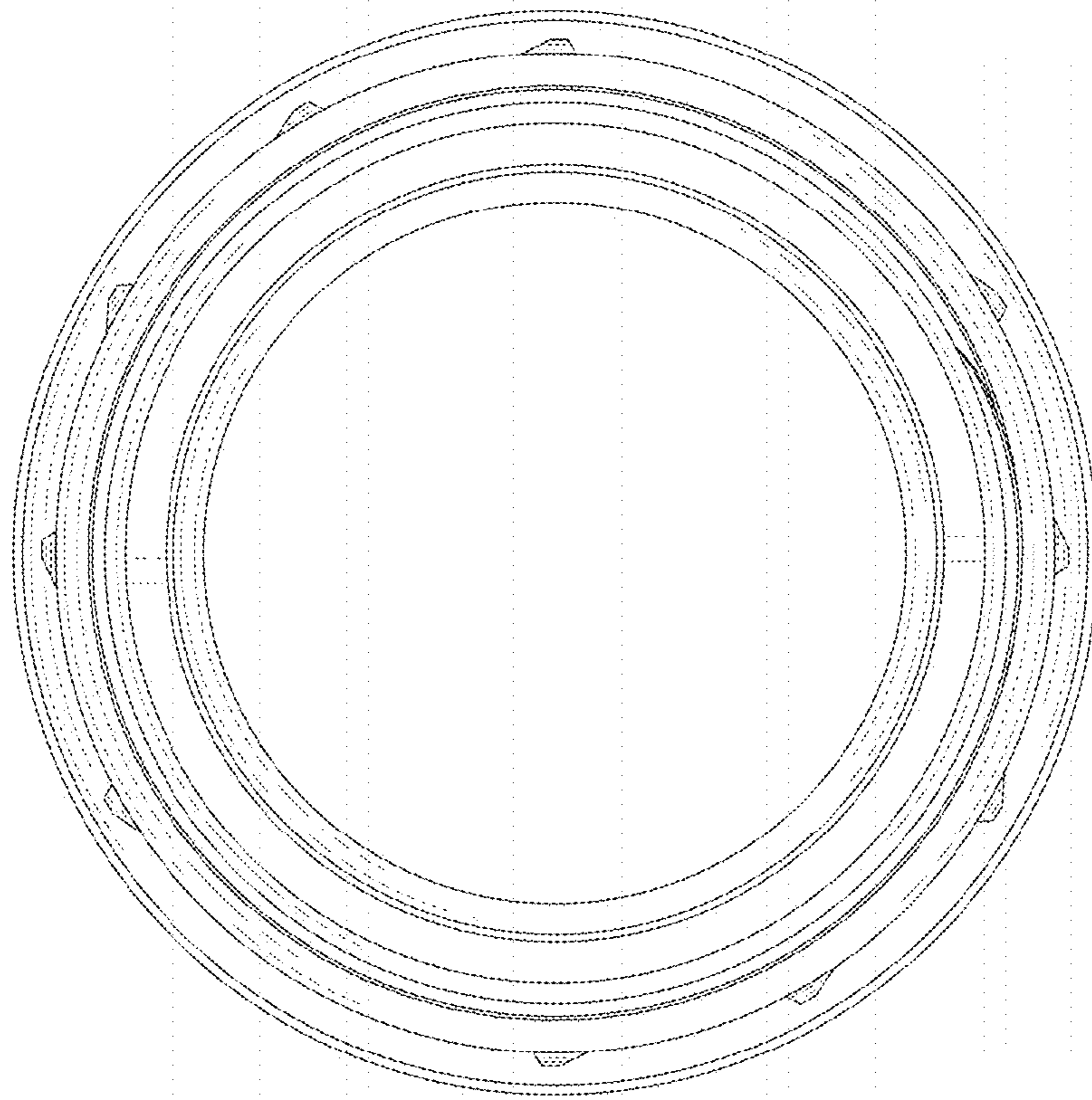

FIG. 25

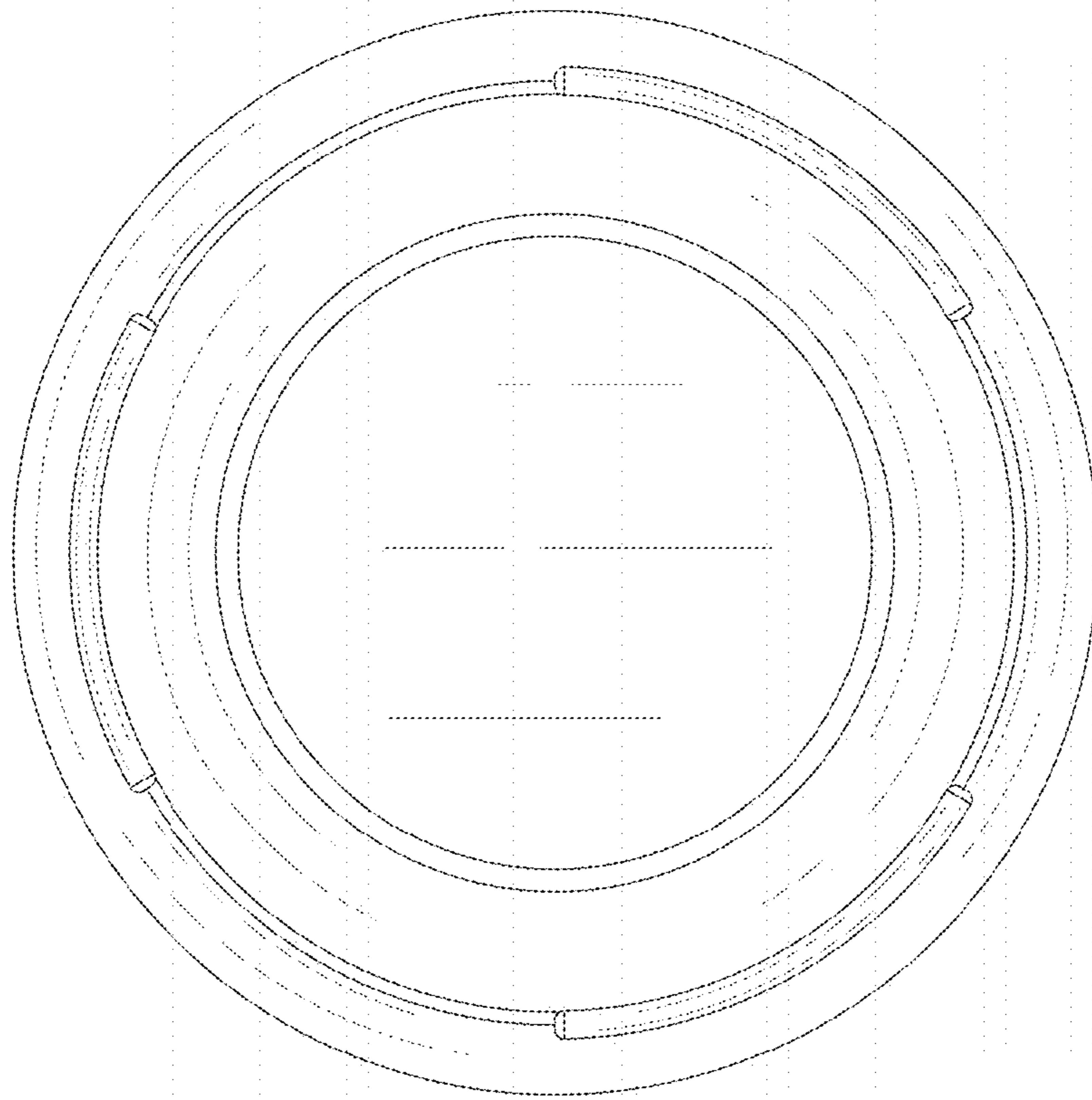

FIG. 26