



US00D918707S

(12) **United States Design Patent**  
**Tao**

(10) **Patent No.:** **US D918,707 S**

(45) **Date of Patent:** **\*\* May 11, 2021**

(54) **VITRIFICATION AND STORAGE DEVICE**

2020/0093122 A1\* 3/2020 Lin ..... A01N 1/0268

\* cited by examiner

(71) Applicant: **Jun Tao**, Mesa, AZ (US)

*Primary Examiner* — John Windmuller

(72) Inventor: **Jun Tao**, Mesa, AZ (US)

(57) **CLAIM**

(\*\*) Term: **15 Years**

The ornamental design for a vitrification and storage device, as shown and described.

(21) Appl. No.: **29/672,179**

**DESCRIPTION**

(22) Filed: **Dec. 4, 2018**

(51) **LOC (13) Cl.** ..... **08-99**

(52) **U.S. Cl.**

USPC ..... **D8/499**

(58) **Field of Classification Search**

USPC ..... D8/499

CPC ... A01N 1/0268; A01N 1/0257; C12M 45/22;

A61B 17/435

See application file for complete search history.

FIG. 1 shows a perspective view of a vitrification and storage device according to the claimed design.

FIG. 2 shows a front elevation view thereof;

FIG. 3 shows a rear elevation view thereof;

FIG. 4 shows a top plan view thereof;

FIG. 5 shows a bottom plan view thereof;

FIG. 6 shows a left side elevation view thereof;

FIG. 7 shows a right side elevation view thereof;

FIG. 8 shows an enlarged detail front elevation view of the tip portion thereof.

FIG. 9 shows an enlarged detail right side elevation view of the tip portion thereof.

FIG. 10 shows a perspective view of a second embodiment of a vitrification and storage device according to the claimed design.

FIG. 11 shows a front elevation view thereof;

FIG. 12 shows a rear elevation view thereof;

FIG. 13 shows a top plan view thereof;

FIG. 14 shows a bottom plan view thereof;

FIG. 15 shows a left side elevation view thereof;

FIG. 16 shows a right side elevation view thereof;

FIG. 17 shows an enlarged detail front elevation view of the tip portion thereof; and,

FIG. 18 shows an enlarged detail right side elevation view of the tip portion thereof.

(56) **References Cited**

**U.S. PATENT DOCUMENTS**

9,516,876	B2 *	12/2016	Inoue	.....	A01N 1/0268
9,538,746	B2 *	1/2017	Inoue	.....	A01N 1/0257
10,834,920	B1 *	11/2020	Nemeth	.....	A01N 1/0268
2008/0038155	A1 *	2/2008	Chian	.....	C12N 1/04
					422/400
2011/0196358	A1 *	8/2011	Criado Scholz	.....	A01N 1/0268
					606/20
2011/0275153	A1 *	11/2011	Butler	.....	A01N 1/0268
					435/374
2016/0235056	A1 *	8/2016	Momozawa	.....	C12M 45/22
2017/0135335	A1 *	5/2017	Matsuzawa	.....	A01N 1/0268
2019/0141986	A1 *	5/2019	Inui	.....	C12M 21/06
					422/40

**1 Claim, 4 Drawing Sheets**

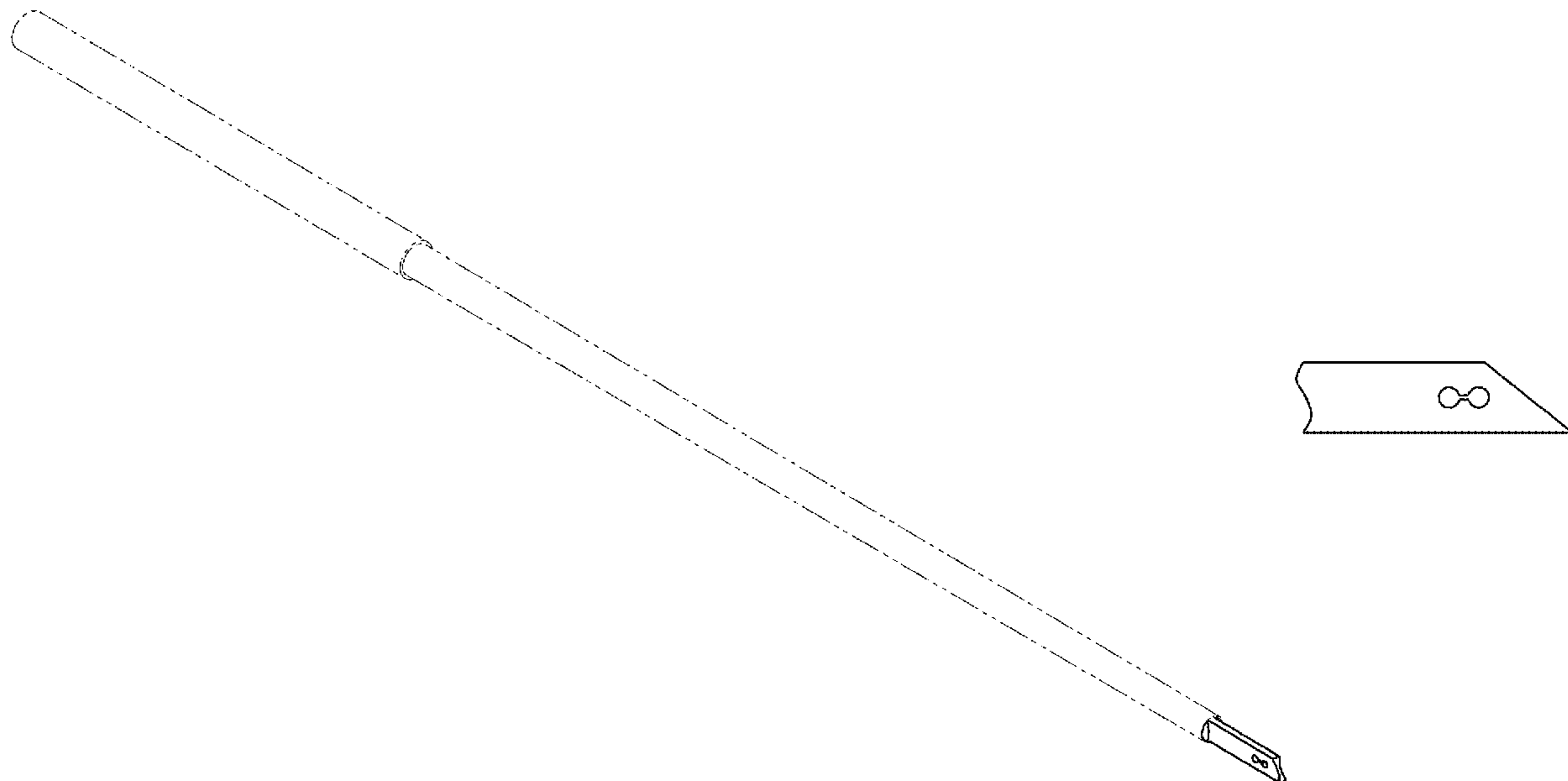

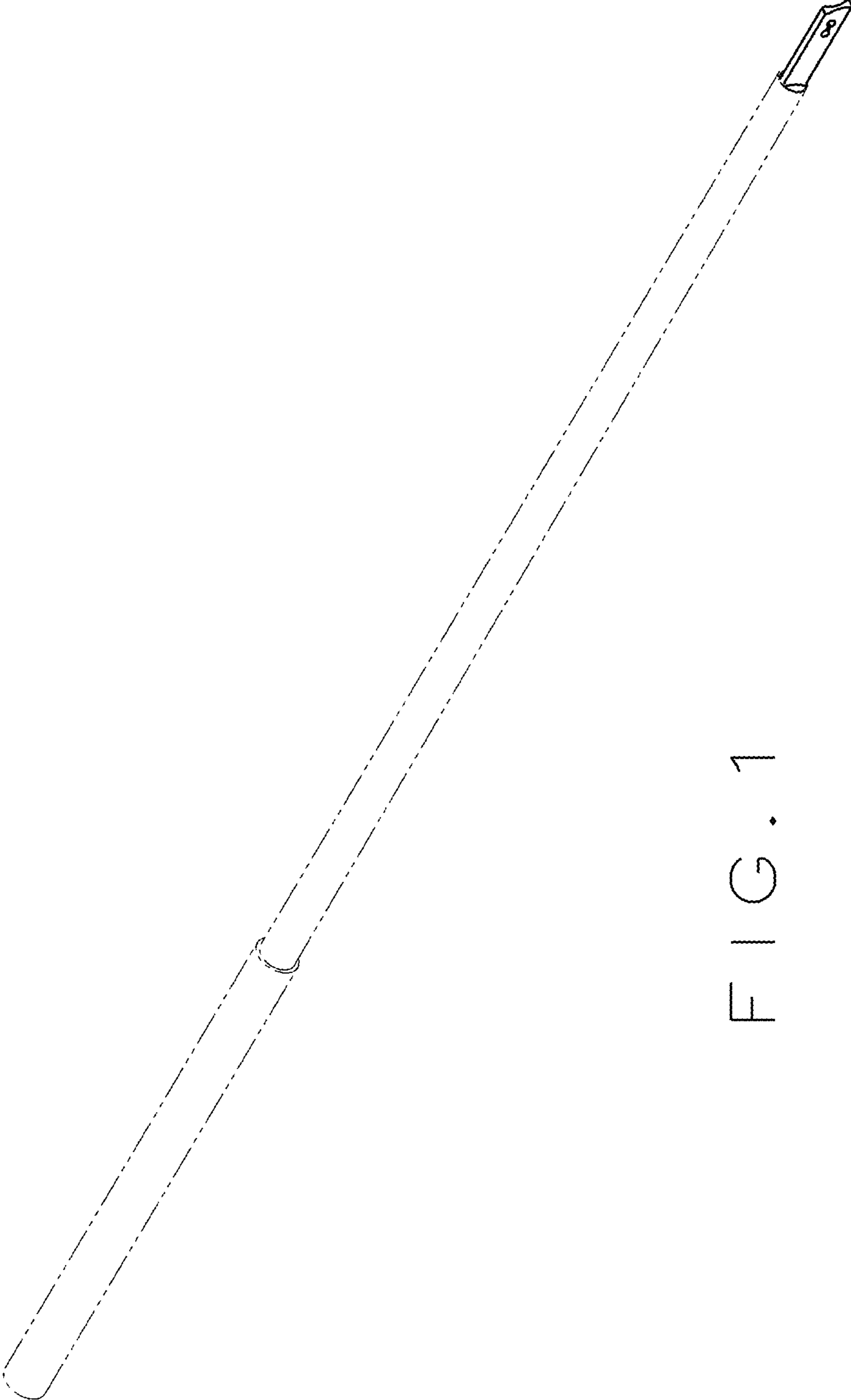

FIG. 1

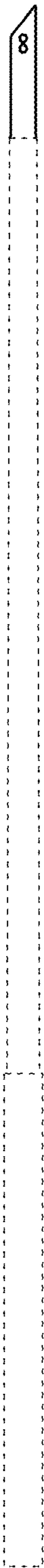

FIG. 2

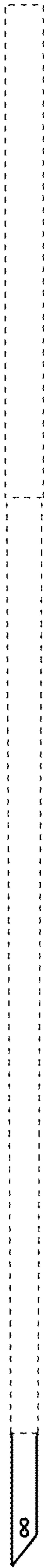

FIG. 3

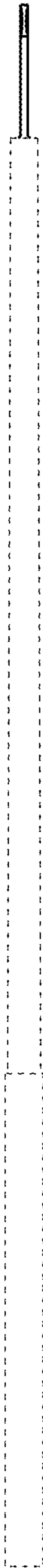

FIG. 4



FIG. 5



FIG. 6

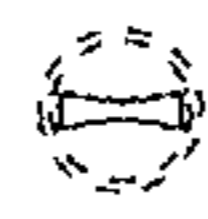

FIG. 7

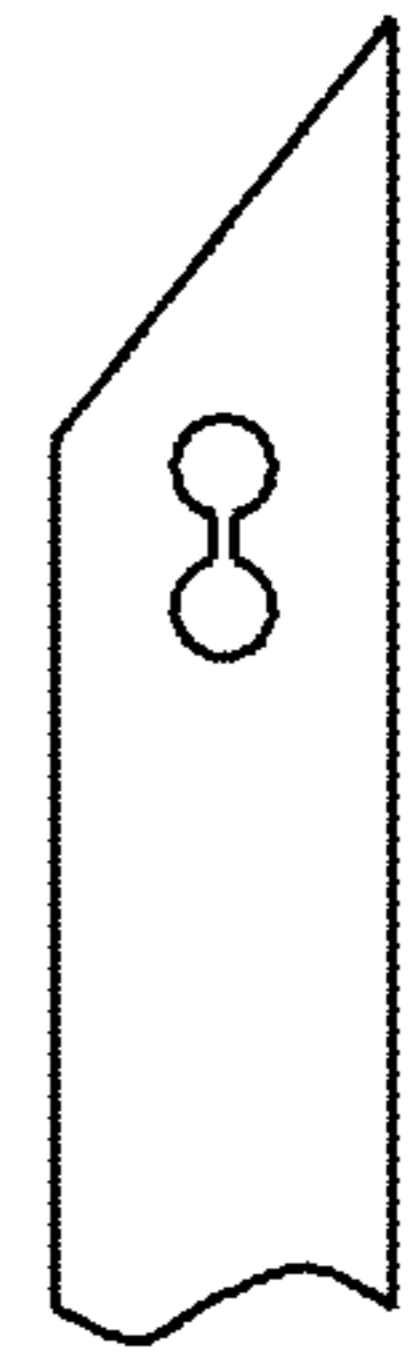

FIG. 8

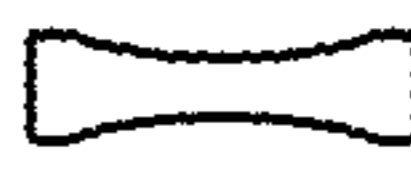

FIG. 9

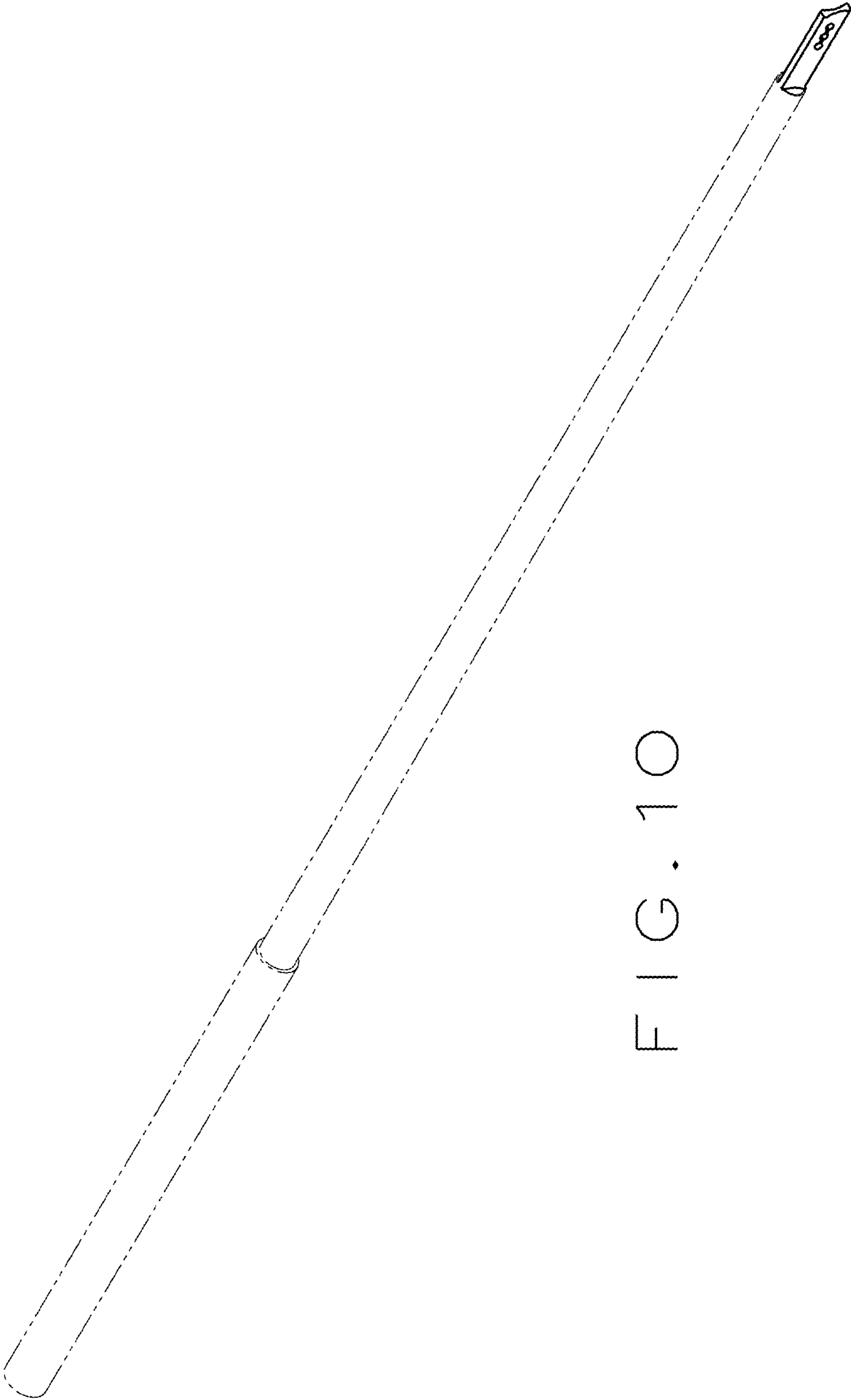

FIG. 10

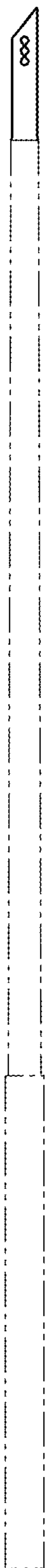

FIG. 11



FIG. 12

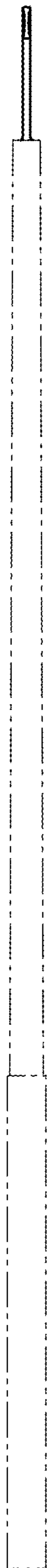

FIG. 13

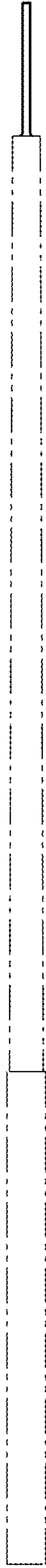

FIG. 14



FIG. 15



FIG. 16

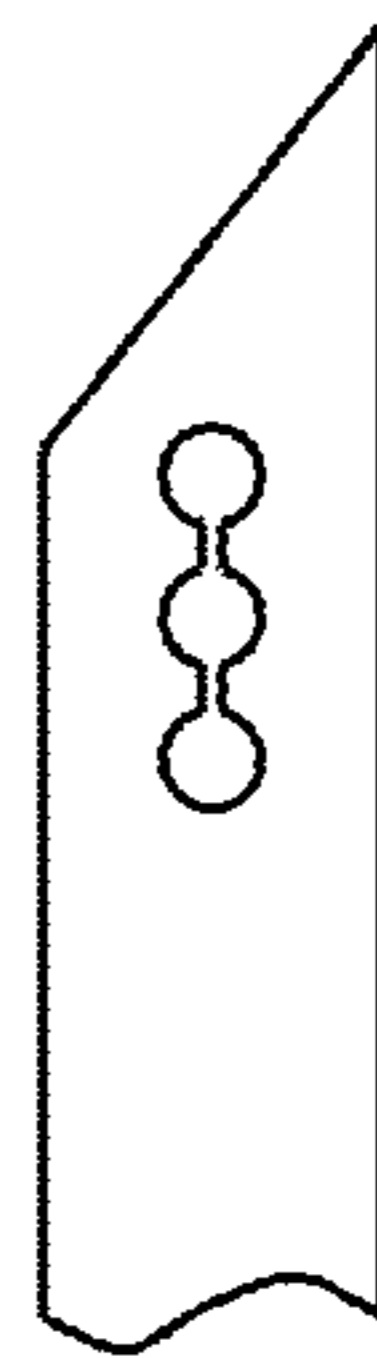

FIG. 17

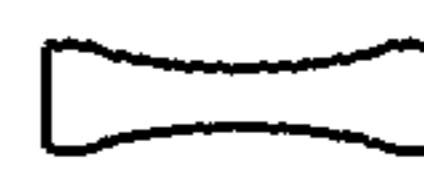

FIG. 18