



US00D918644S

(12) **United States Design Patent** (10) **Patent No.:** **US D918,644 S**
Li (45) **Date of Patent:** **** May 11, 2021**

(54) **DRIED BEANS MACHINE**
(71) Applicant: **Yiwu Aoke Trading Co., Ltd., Yiwu (CN)**
(72) Inventor: **Bin Li, Shuangfeng (CN)**
(**) Term: **15 Years**
(21) Appl. No.: **29/748,735**
(22) Filed: **Sep. 1, 2020**
(51) **LOC (13) Cl.** **07-02**
(52) **U.S. Cl.**
USPC **D7/354**
(58) **Field of Classification Search**
USPC D7/323, 354-361, 391, 393; D21/525
CPC A47J 27/00; A47J 27/004; A47J 27/08;
A47J 27/0802; A47J 27/0804; A47J
27/0811; A47J 27/0813; A47J 27/0815;
A47J 27/0817; A47J 27/084; A47J 27/09;
A47J 27/092; A47J 36/025; A47J 36/06;
A47J 37/12; A47J 37/1204; A47J
37/1209; A47J 45/07; A47J 45/071; A47J
45/074; A47J 45/08; B01D 2201/345;
B01J 3/03; B01J 3/04; F01P 2011/0247;
F01P 2011/0252; H05B 6/00; H05B 6/02;
H05B 6/06
See application file for complete search history.

D668,509 S 10/2012 Beugelsdijk et al.
D670,956 S 11/2012 Kokenis
D704,500 S * 5/2014 Kim D7/354
D711,679 S * 8/2014 Day D7/354
D715,088 S * 10/2014 Kim D7/354
D793,798 S * 8/2017 Carpenter D7/354
D830,103 S * 10/2018 Cao D7/354
D836,968 S * 1/2019 Chung D7/354
D845,059 S 4/2019 Nie
D850,185 S * 6/2019 Terao D7/354
D854,875 S * 7/2019 Tan D7/358
D899,178 S * 10/2020 Ye D7/358

OTHER PUBLICATIONS

Kolua Wax Digital Wax Warmer Hair Removal with Hard Wax Beans. Latest Date First known on Amazon.com review Feb. 11, 2020. <https://www.amazon.com/gp/product/B07X7HJQJ61/ref> (Year: 2020).*

* cited by examiner

Primary Examiner — Ricky Pham

(57) **CLAIM**

The ornamental design for a dried beans machine, as shown and described.

DESCRIPTION

FIG. 1 is a perspective view of a dried beans machine showing my new design;
FIG. 2 is a front view thereof;
FIG. 3 is a back view thereof;
FIG. 4 is a left side view thereof;
FIG. 5 is a right side view thereof;
FIG. 6 is a top view thereof; and,
FIG. 7 is a bottom view thereof.

1 Claim, 7 Drawing Sheets

(56) **References Cited**
U.S. PATENT DOCUMENTS
D347,352 S * 5/1994 Myers D7/354
D369,270 S * 4/1996 Payen D7/323
D380,504 S * 7/1997 Yang D21/525
D667,255 S * 9/2012 Reiner D7/354

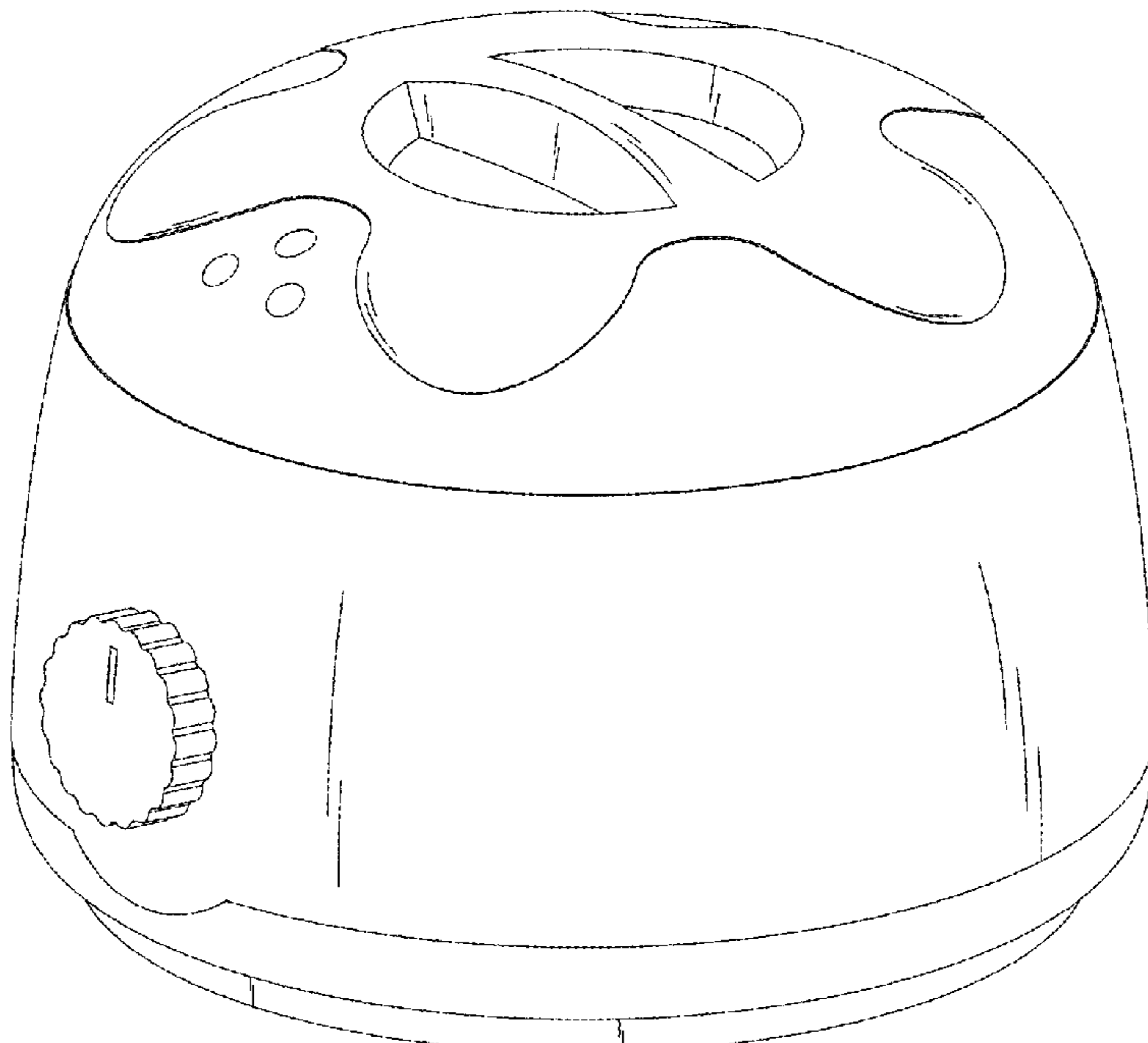

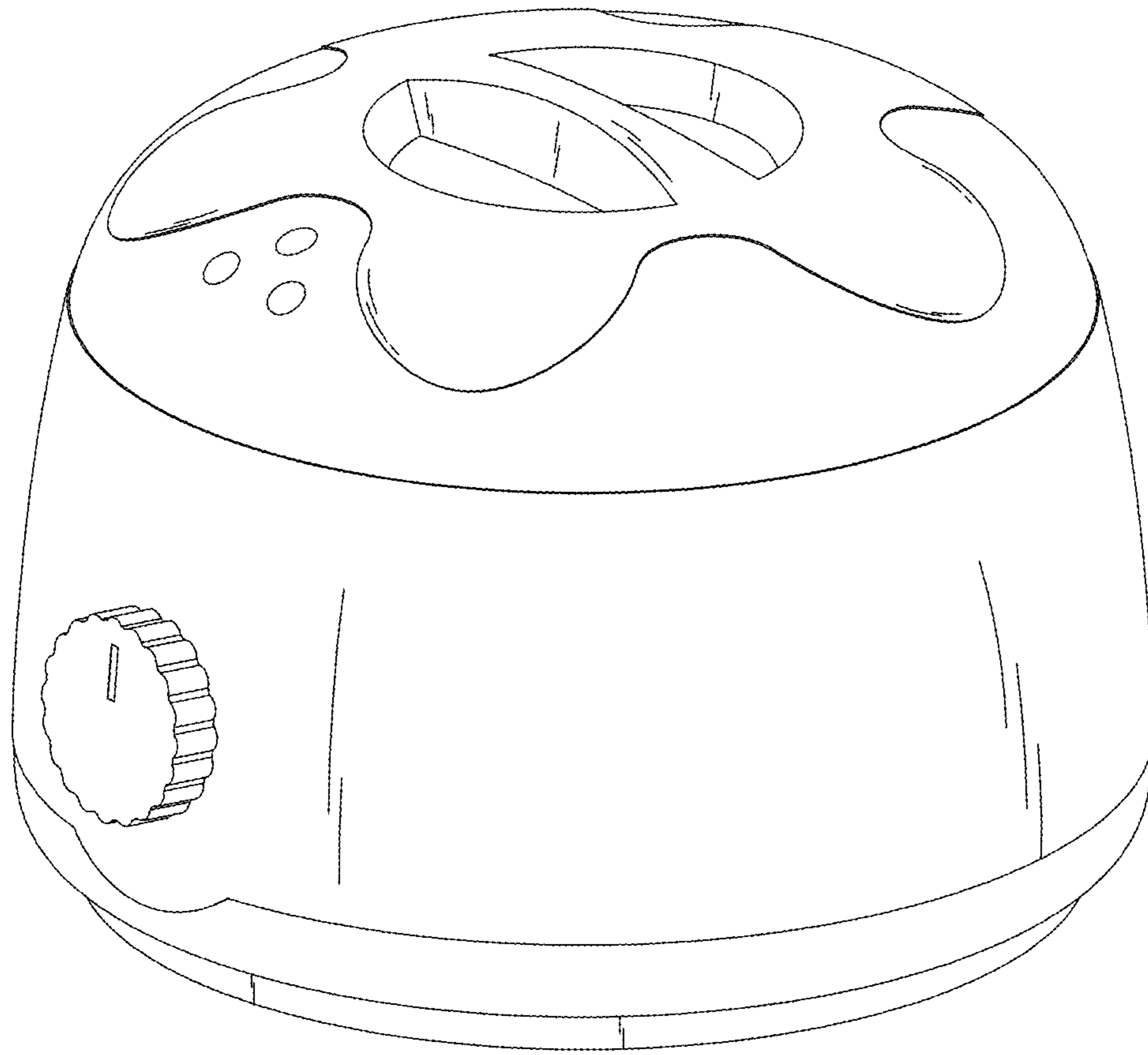

FIG. 1

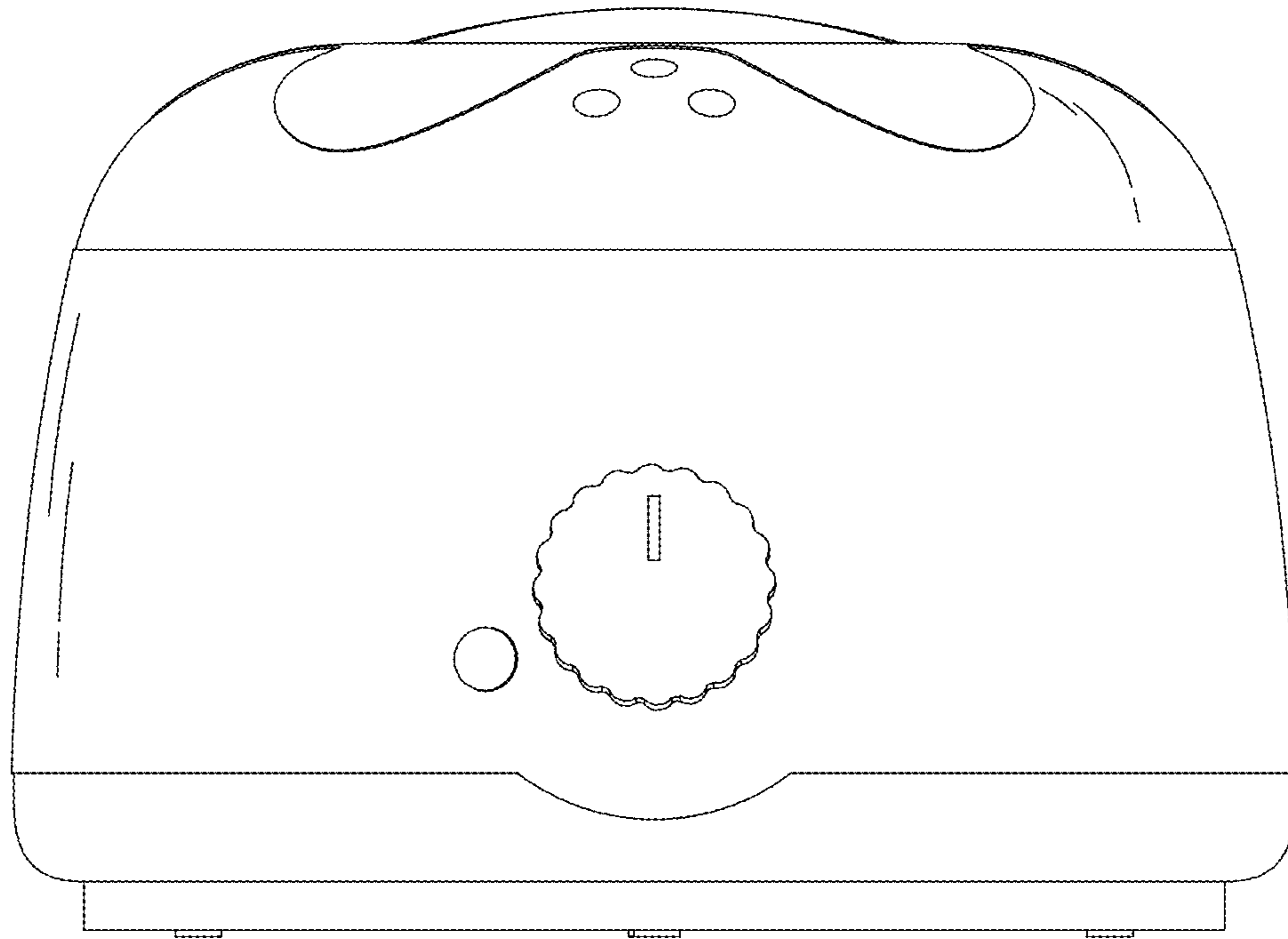

FIG. 2

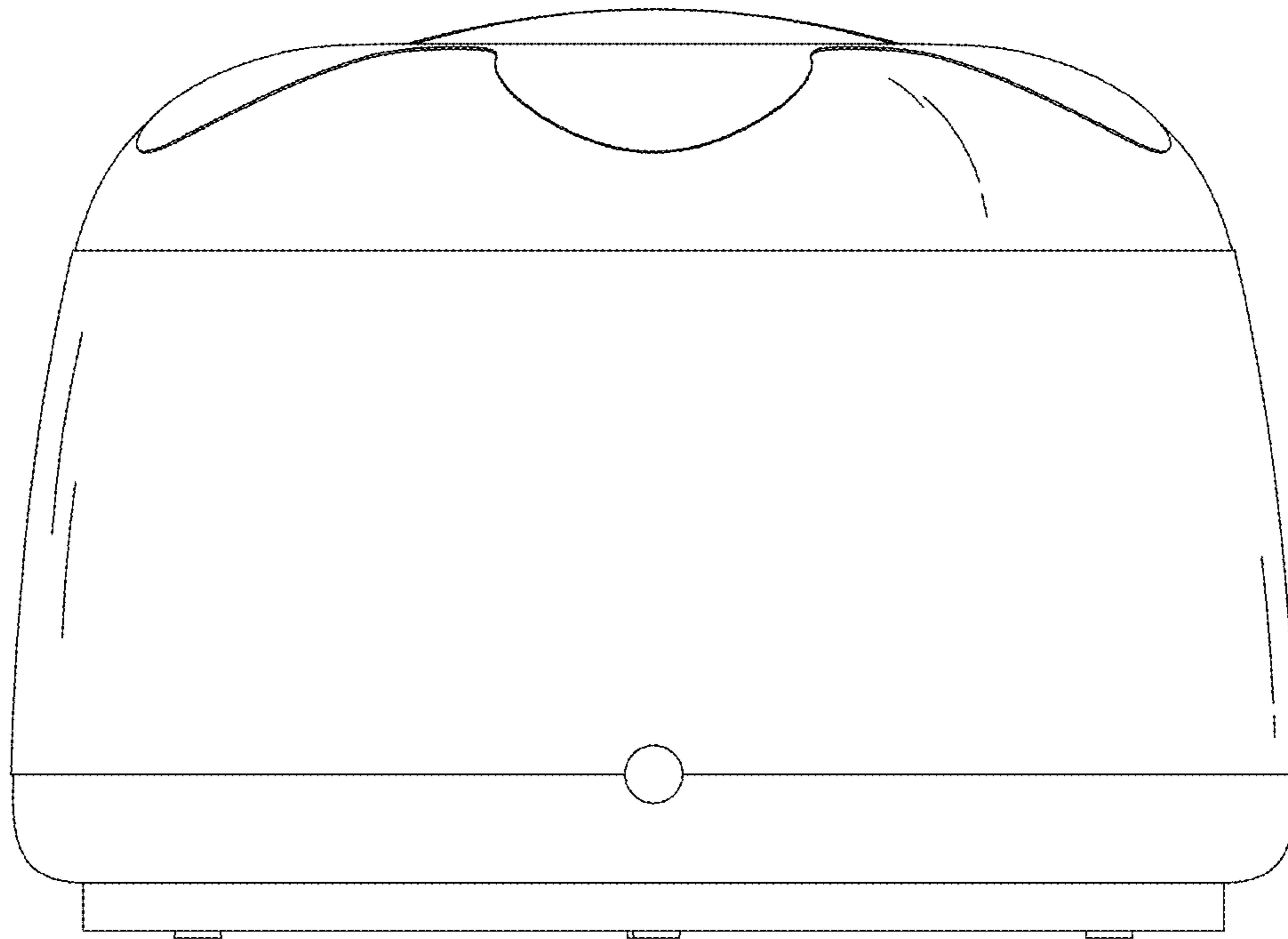

FIG. 3

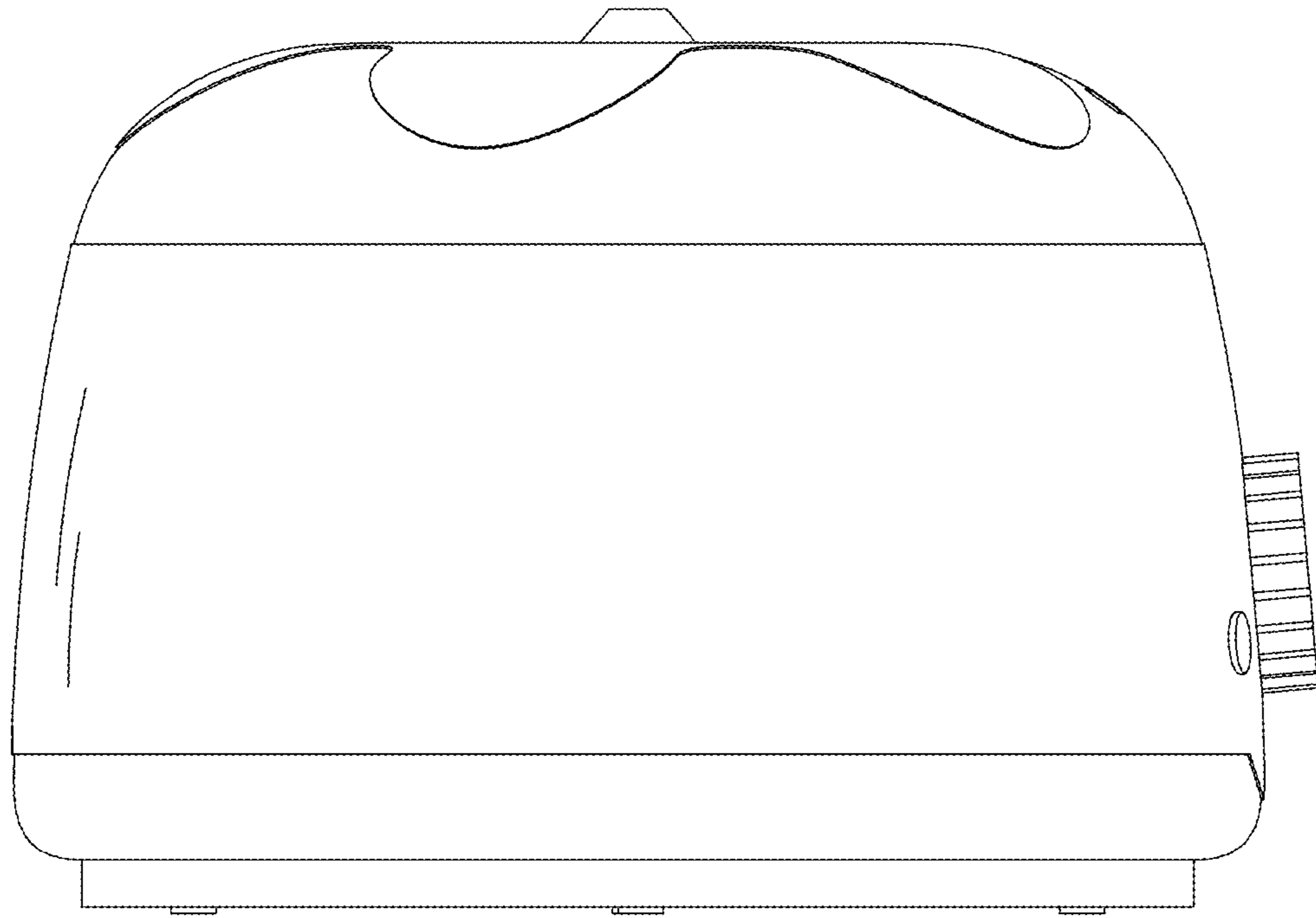

FIG. 4

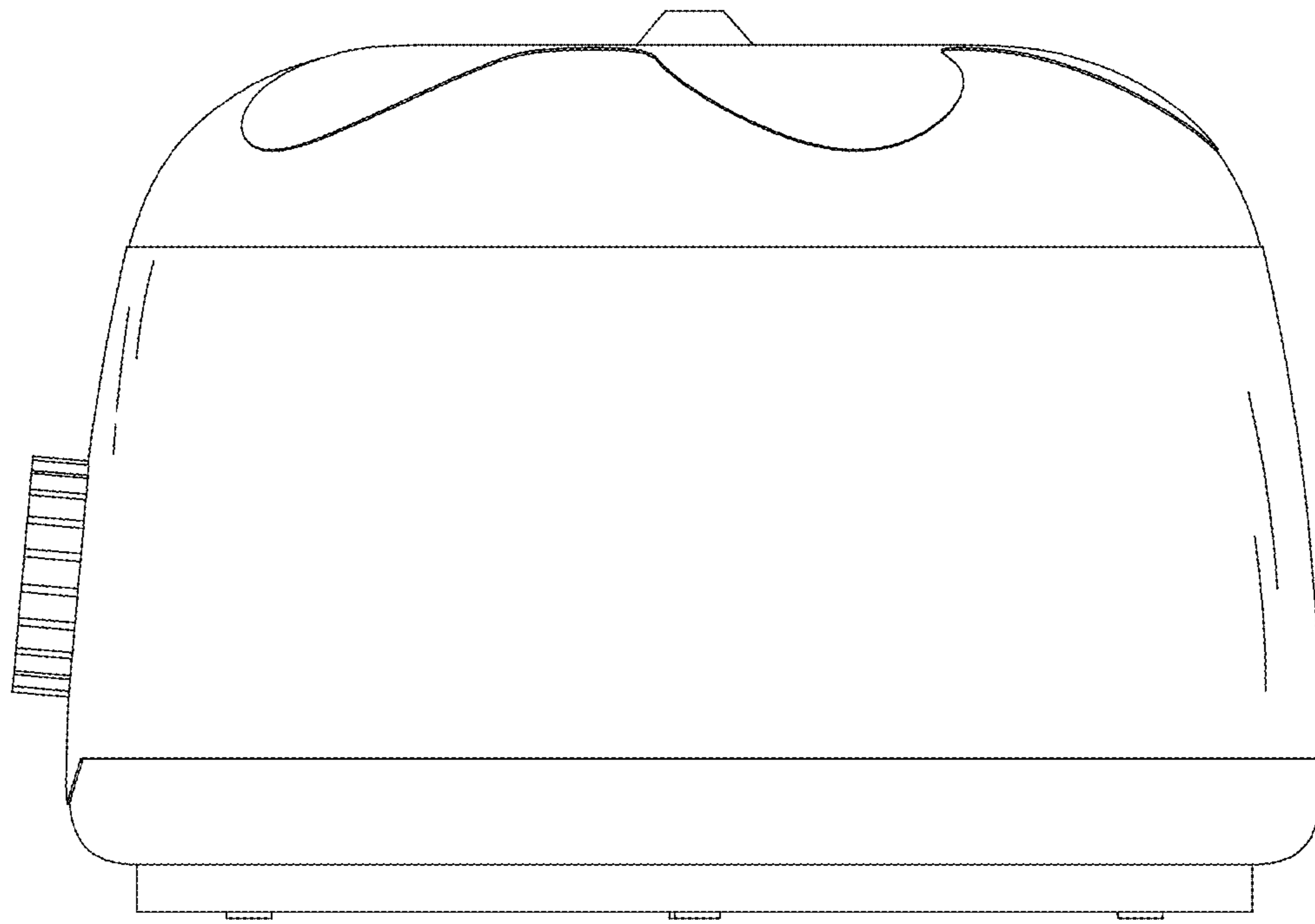

FIG. 5

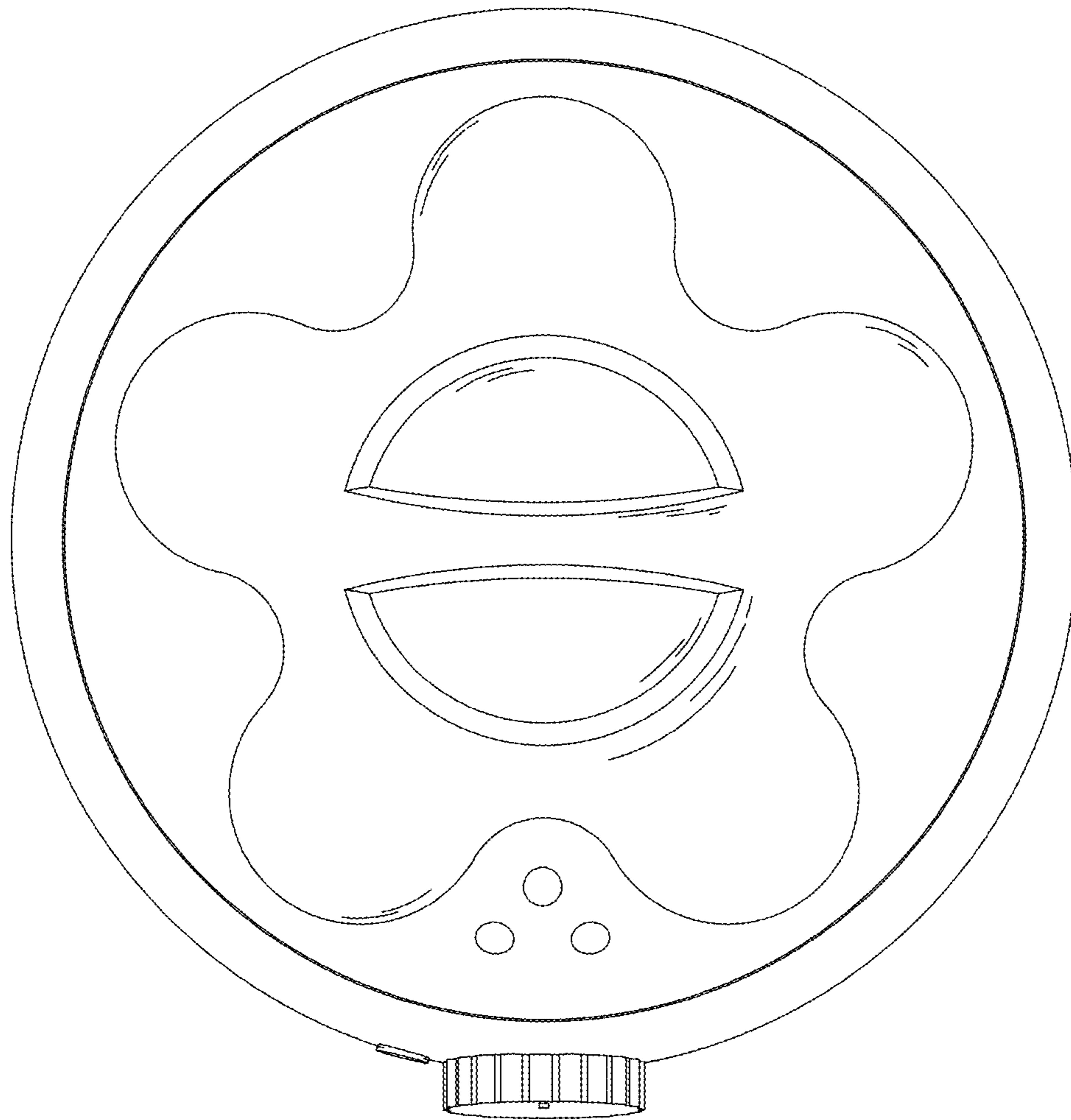

FIG. 6

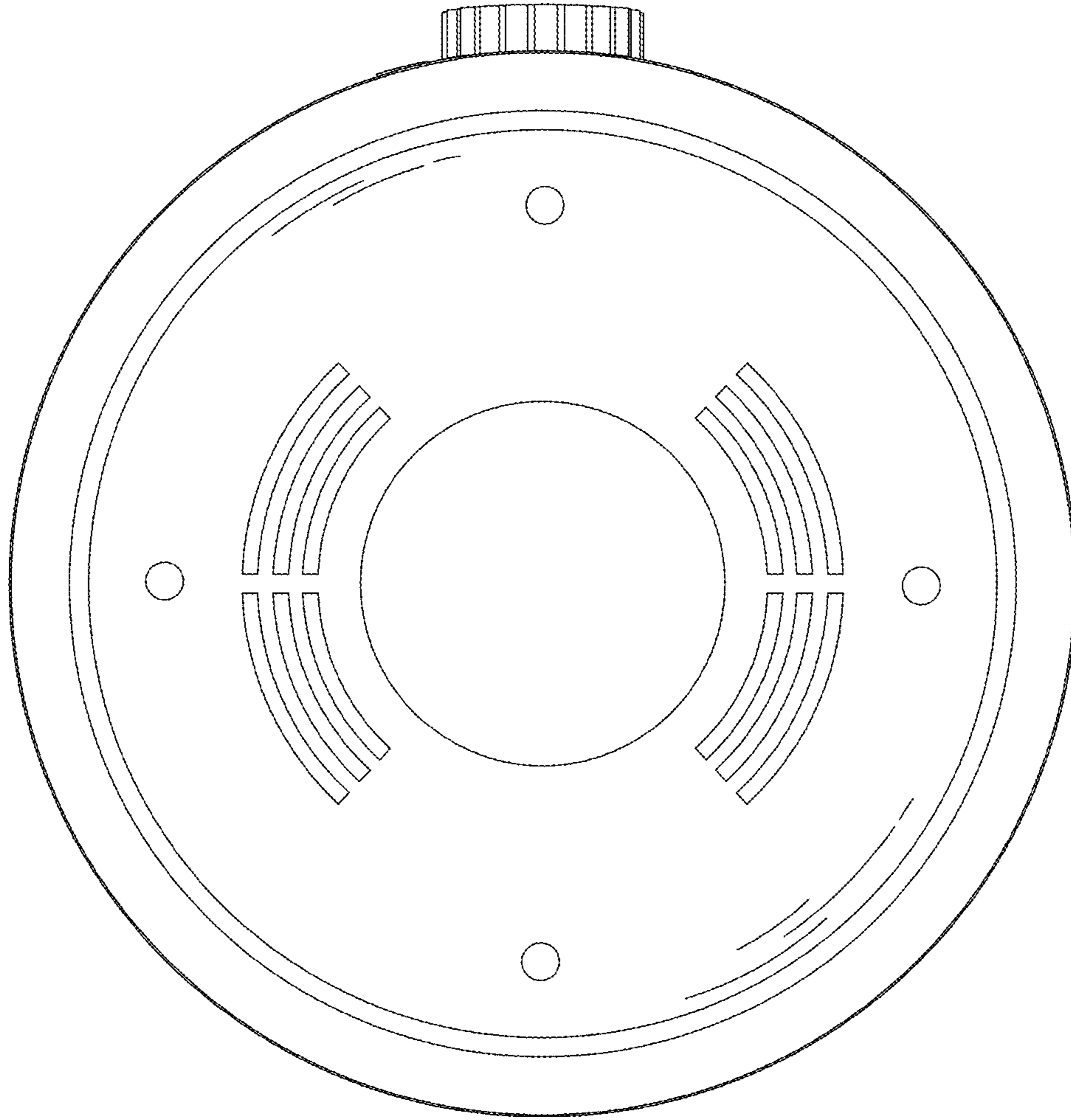

FIG. 7