

US00D918613S

(12) **United States Design Patent** (10) **Patent No.:** **US D918,613 S**
Davis et al. (45) **Date of Patent:** **** May 11, 2021**

(54) **PATIO FURNITURE**

(74) *Attorney, Agent, or Firm* — Workman Nydegger

(71) Applicant: **WALKER EDISON FURNITURE COMPANY LLC**, Salt Lake City, UT (US)

(57) **CLAIM**

The ornamental design for patio furniture, as shown and described.

(72) Inventors: **Matthew Davis**, Millcreek, UT (US);
Brad Bonham, Draper, UT (US);
Richard Packer, Kaysville, UT (US);
Tiffany Duhadway, Salt Lake City, UT (US)

DESCRIPTION

(73) Assignee: **Walker Edison Furniture Company LLC**, West Jordan, UT (US)

FIG. 1 is a front perspective view of a first embodiment of the patio furniture showing the new design;
FIG. 2 is another front perspective view thereof;
FIG. 3 is a front elevation view thereof;
FIG. 4 is a back elevation view thereof;
FIG. 5 is a top plan view thereof;
FIG. 6 is a bottom plan view thereof;
FIG. 7 is a right elevation view thereof;
FIG. 8 is a left elevation view thereof;
FIG. 9 is a front perspective view of a second embodiment of the patio furniture showing the new design;
FIG. 10 is another front perspective view thereof;
FIG. 11 is another front elevation view thereof;
FIG. 12 is another back elevation view thereof;
FIG. 13 is another top plan view thereof;
FIG. 14 is another bottom plan view thereof;
FIG. 15 is another right elevation view thereof;
FIG. 16 is another left elevation view thereof;
FIG. 17 is a front perspective view of a third embodiment of the patio furniture showing the new design;
FIG. 18 is another front perspective view thereof;
FIG. 19 is another front elevation view thereof;
FIG. 20 is another back elevation view thereof;
FIG. 21 is another top plan view thereof;
FIG. 22 is another bottom plan view thereof;
FIG. 23 is another right elevation view thereof;
FIG. 24 is another left elevation view thereof;
FIG. 25 is a front perspective view of a fourth embodiment of the patio furniture showing the new design;
FIG. 26 is another front perspective view thereof;
FIG. 27 is another front elevation view thereof;
FIG. 28 is another back elevation view thereof;
FIG. 29 is another top plan view thereof;
FIG. 30 is another bottom plan view thereof;
FIG. 31 is another right elevation view thereof; and,
FIG. 32 is another left elevation view thereof.

(**) Term: **15 Years**

(21) Appl. No.: **29/720,953**

(22) Filed: **Jan. 16, 2020**

(51) **LOC (13) Cl.** **06-01**

(52) **U.S. Cl.**
USPC **D6/378**

(58) **Field of Classification Search**
USPC D6/368, 370, 371, 373, 374, 375, 379,
D6/717, 377, 580; D21/519, 521
(Continued)

(56) **References Cited**

U.S. PATENT DOCUMENTS

2,322,147 A * 6/1943 Landauer A47K 3/12
4/574.1

D162,889 S * 4/1951 Schmidli D6/338
(Continued)

OTHER PUBLICATIONS

U.S. Appl. No. 29/721,161, filed Jan. 17, 2020, Davis.
(Continued)

Primary Examiner — Kevin K Rudzinski

Assistant Examiner — Paul D Bohannon

(Continued)

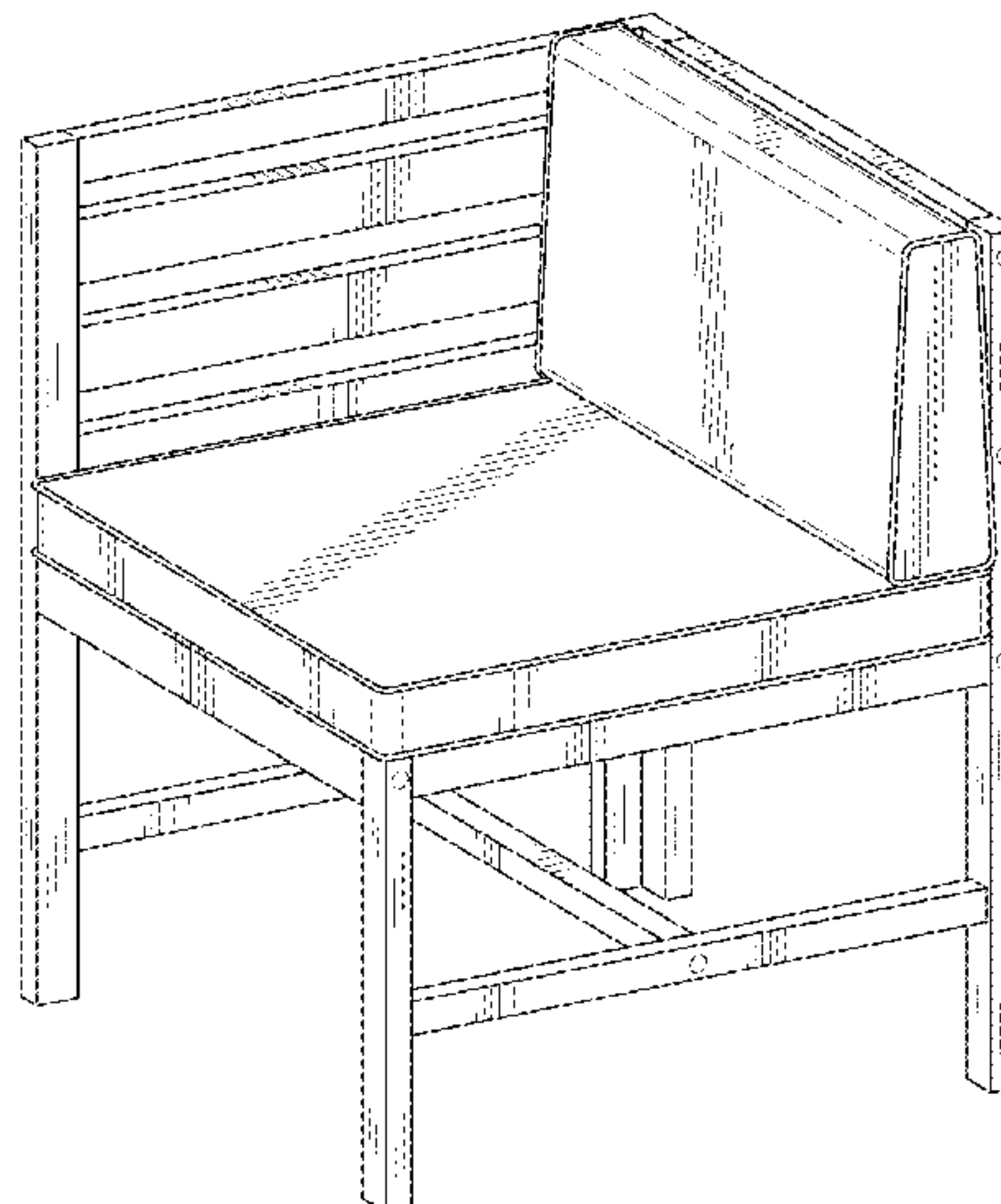

The broken lines in the drawings are for the purpose of illustrating portions of the patio furniture that form no part of the claimed design.

1 Claim, 20 Drawing Sheets

(58) Field of Classification Search

CPC A47C 4/08; A47C 4/00; A47C 7/70; A47C 7/405; A47C 13/00

See application file for complete search history.

(56)

References Cited

U.S. PATENT DOCUMENTS

D180,689	S	*	7/1957	Jiranek	D6/377
D198,906	S	*	8/1964	McRee	D6/377
D211,336	S	*	6/1968	Kettman	D6/370
D222,051	S	*	9/1971	Shannon	D6/381
D229,591	S	*	12/1973	Trail et al.	D6/370
D243,427	S	*	2/1977	Watts	D6/364
D244,078	S	*	4/1977	Marks	D6/371
D259,600	S	*	6/1981	Marks	D6/378
D259,605	S	*	6/1981	Marks	D6/378
D259,606	S	*	6/1981	Marks	D6/371
D259,901	S	*	7/1981	Herbert, Sr.	D6/370
D261,830	S	*	11/1981	Marks	D6/361
D298,787	S	*	12/1988	Greene	D6/370
D346,281	S	*	4/1994	Vidal	D6/370
D466,318	S	*	12/2002	Arnold	D6/370
D487,988	S	*	4/2004	Hutton	D6/370
D490,995	S	*	6/2004	Hutton	D6/364

D580,668	S	*	11/2008	Miyakawa	D6/357
D680,346	S	*	4/2013	Pedersen	D6/370
D684,786	S	*	6/2013	McCord	D6/370
8,550,547	B1	*	10/2013	Liu	A47C 7/70 297/121
D714,565	S	*	10/2014	Davis	D6/377
D715,568	S	*	10/2014	Davis	D6/370
D839,615	S	*	2/2019	Tham	D6/335
D843,125	S	*	3/2019	Pontillas	D6/370
D897,714	S	*	10/2020	Batson	D6/370
D901,203	S	*	11/2020	Davis	D6/370
D903,357	S	*	12/2020	Davis	D6/370

OTHER PUBLICATIONS

U.S. Appl. No. 29/721,163, filed Jan. 17, 2020, Davis.
 Wednesday Watch List, <https://www.pinterest.com/pin/33636328451508078/>; Retrieved on Jul. 18, 2018.
 Life On Virginia Street, Wednesday Watch List, <https://lifeonvirginiastreet.com/2016/01/wednesday-watch-list-61/>; Retrieved on Jul. 18, 2018.
 Stephen Kenn; Turning a Surplus Military Materials Bonanza into a . . . , <https://www.pinterest.com/pin/33636328451574287/>; Retrieved on Jul. 18, 2018.
 Stephen Kenn; Turning a Surplus Military Materials Bonanza into a Locally Produced Furniture Line, [https://www.core77.com/posts/23185/stephen-kenn-turning-a-surplus-military-materials-bonanza-into-a-locally-produced-furniture-line-23185?utm_source=feedburner&utm_medium=feed&utm_campaign=Feed%3a+core77%2fblog+\(Core77.com%27s+design+blog\)&utm_content=Google+Reader](https://www.core77.com/posts/23185/stephen-kenn-turning-a-surplus-military-materials-bonanza-into-a-locally-produced-furniture-line-23185?utm_source=feedburner&utm_medium=feed&utm_campaign=Feed%3a+core77%2fblog+(Core77.com%27s+design+blog)&utm_content=Google+Reader); Retrieved on Jul. 11, 2018.

* cited by examiner

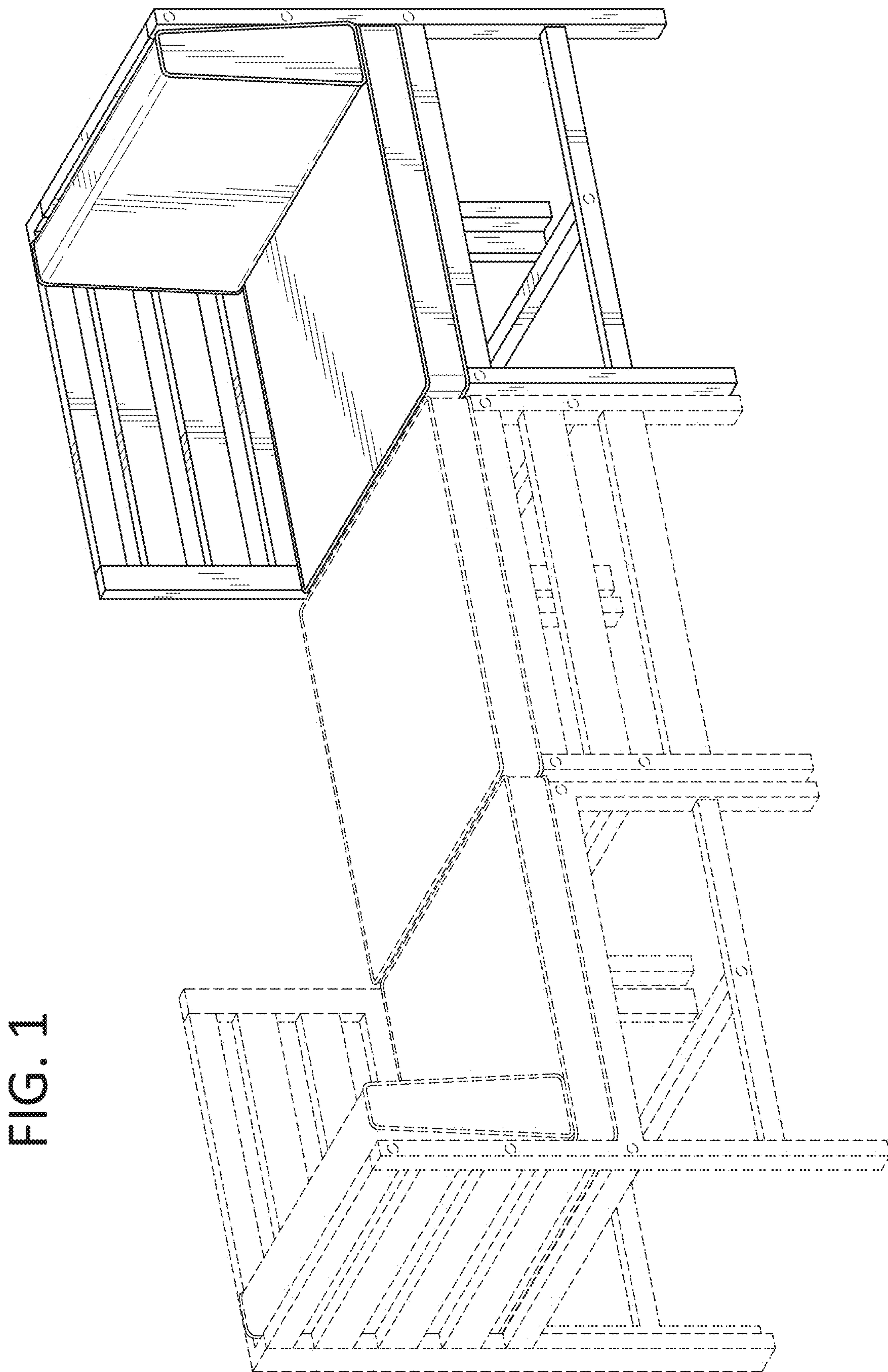

FIG. 1

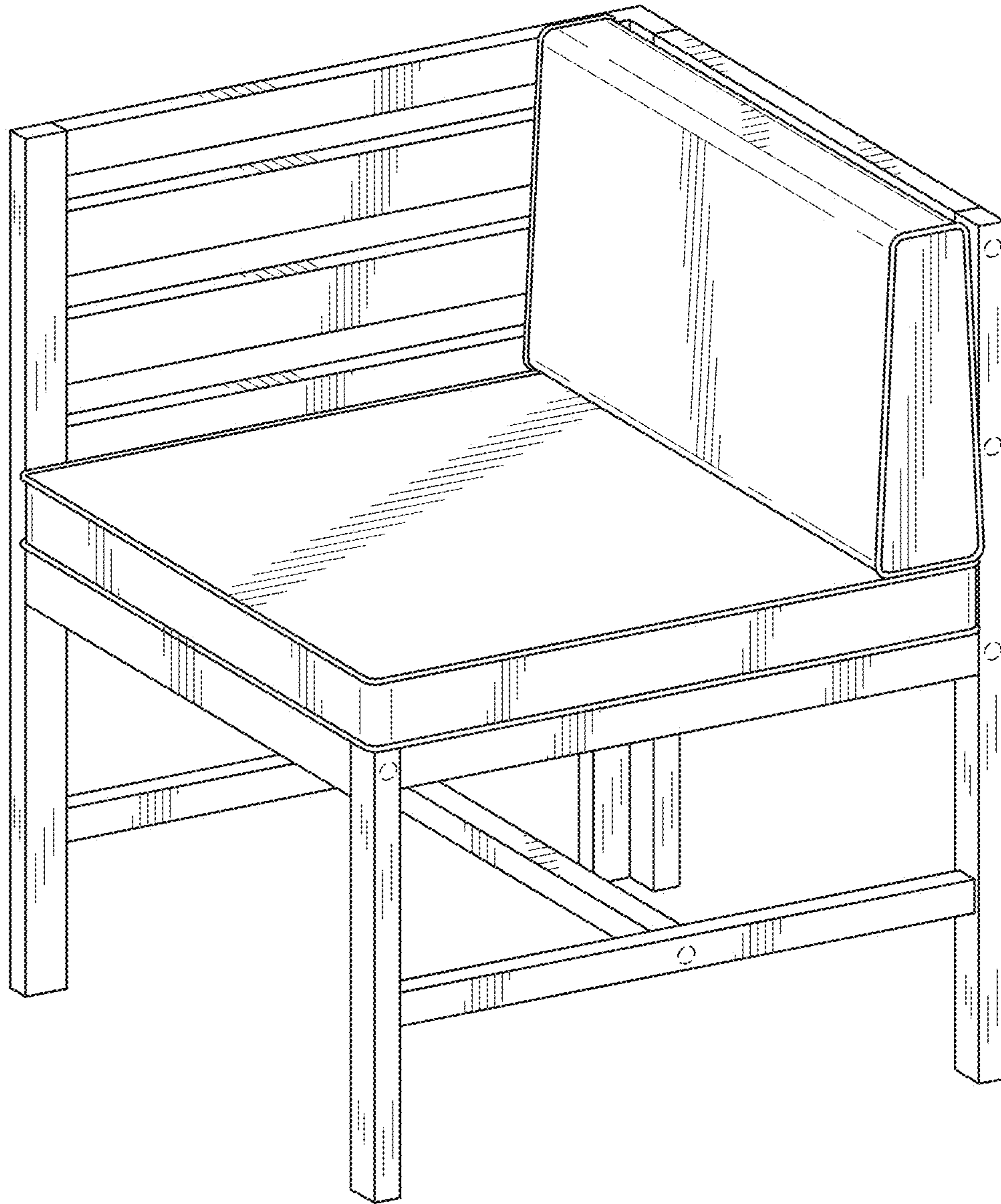

FIG. 2

FIG. 3

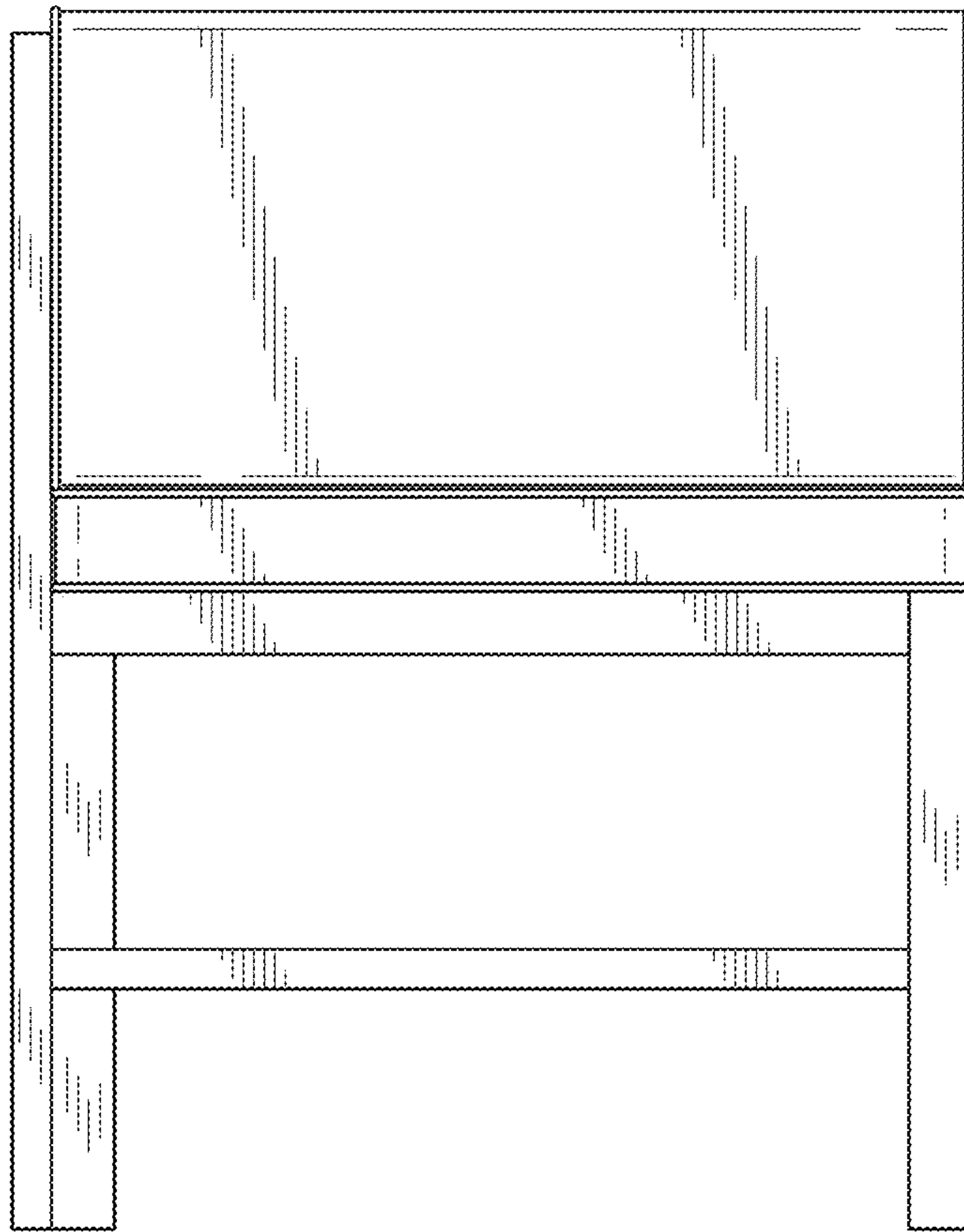
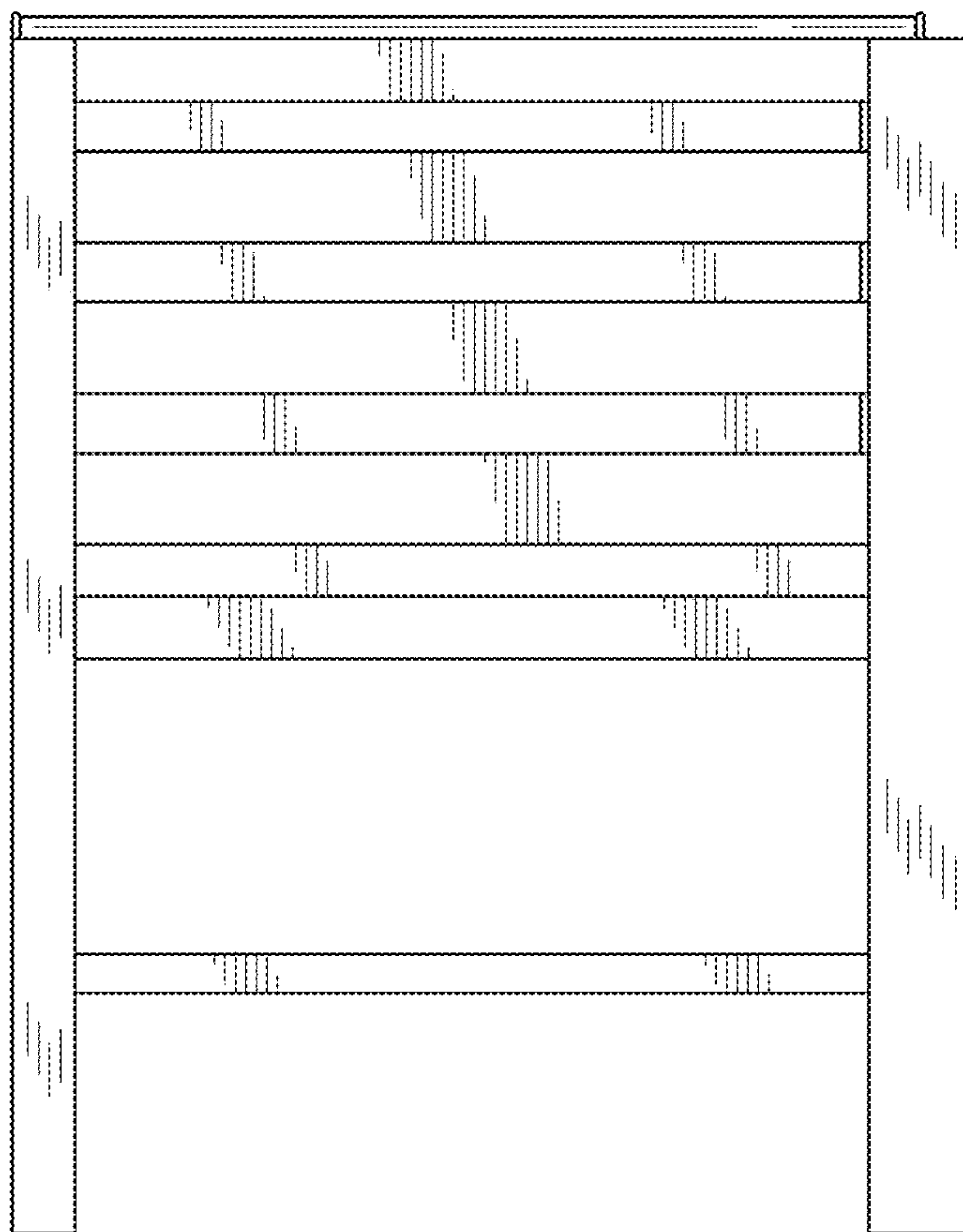

FIG. 4



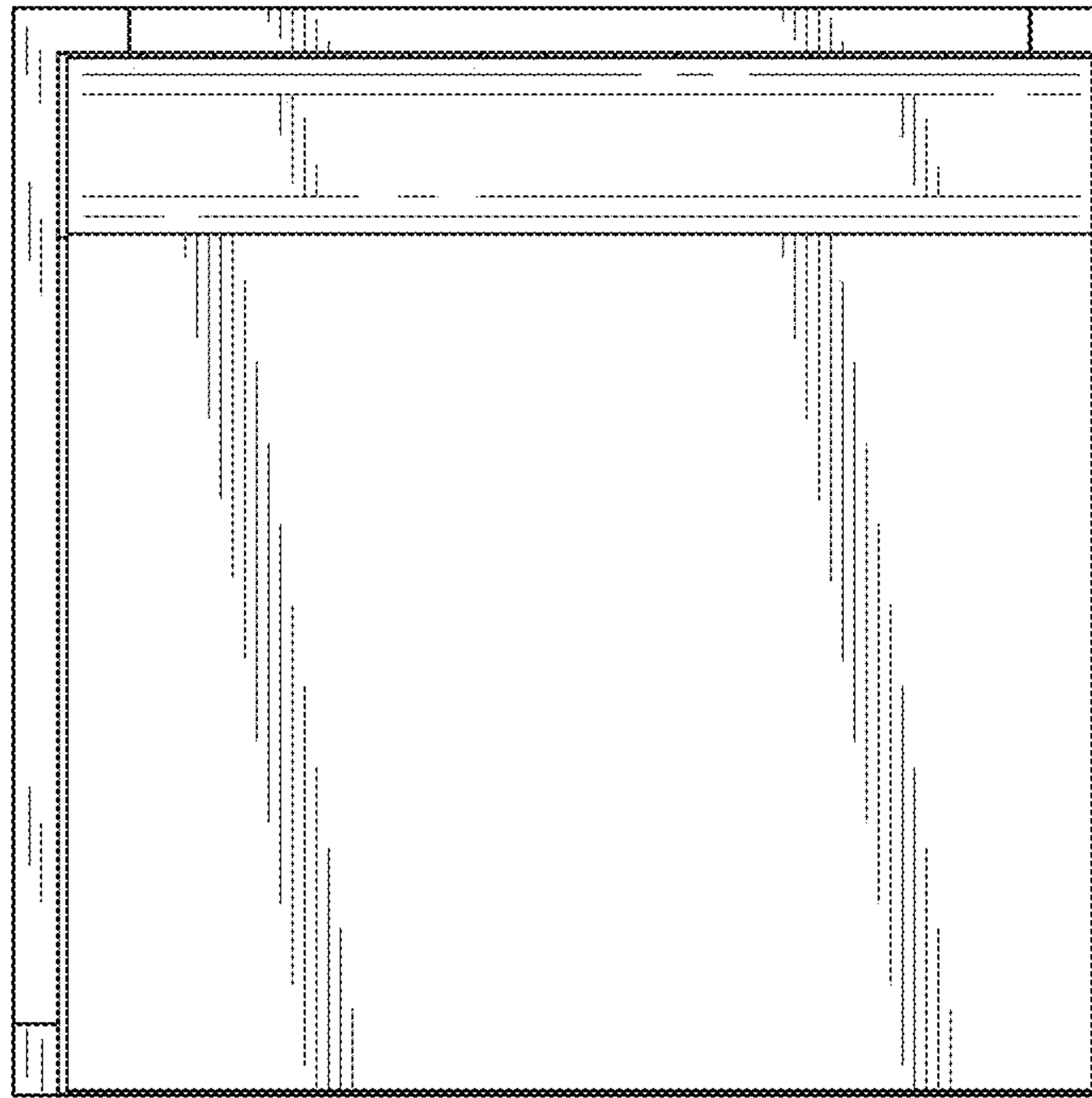

FIG. 5

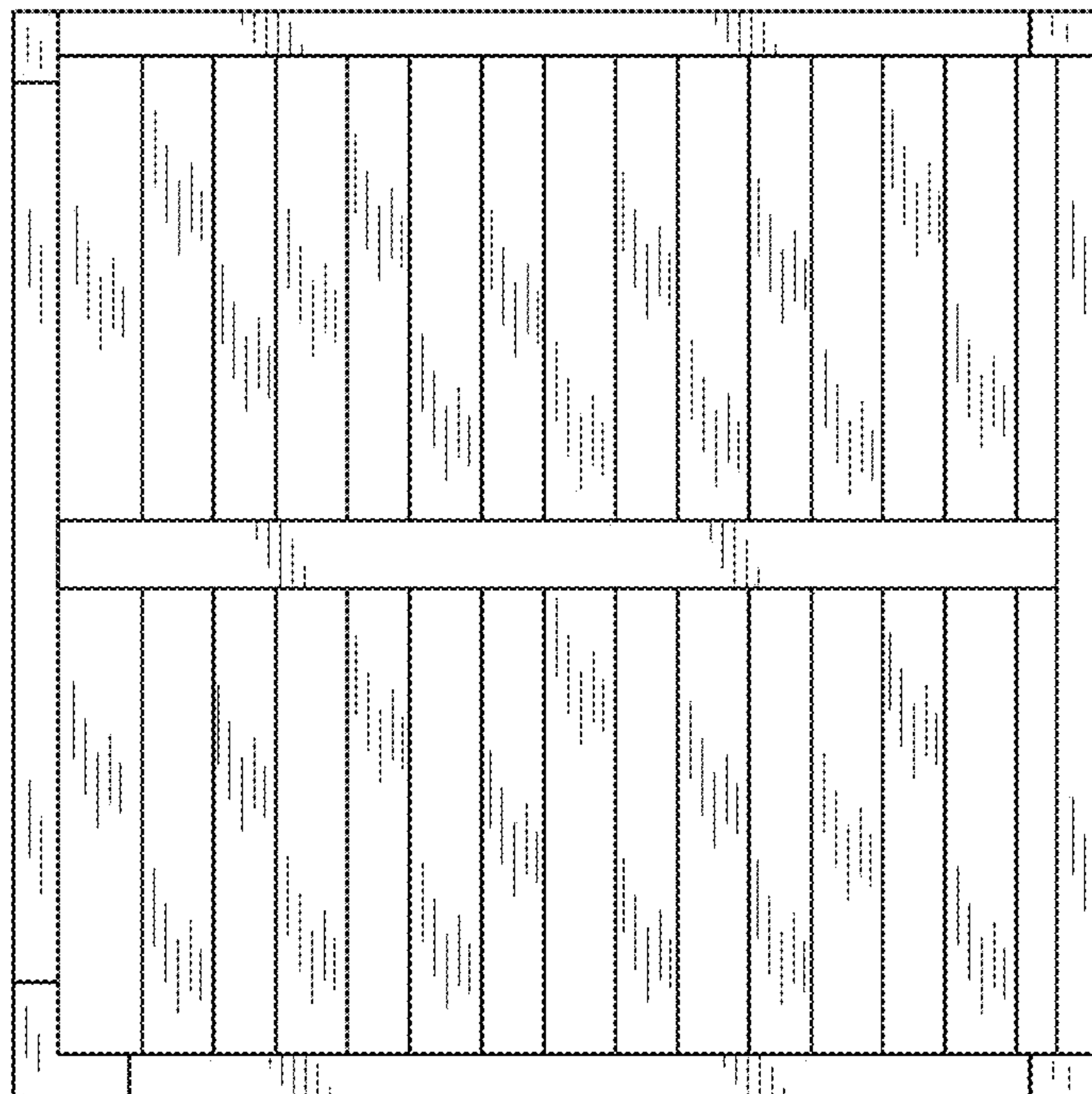

FIG. 6

FIG. 7

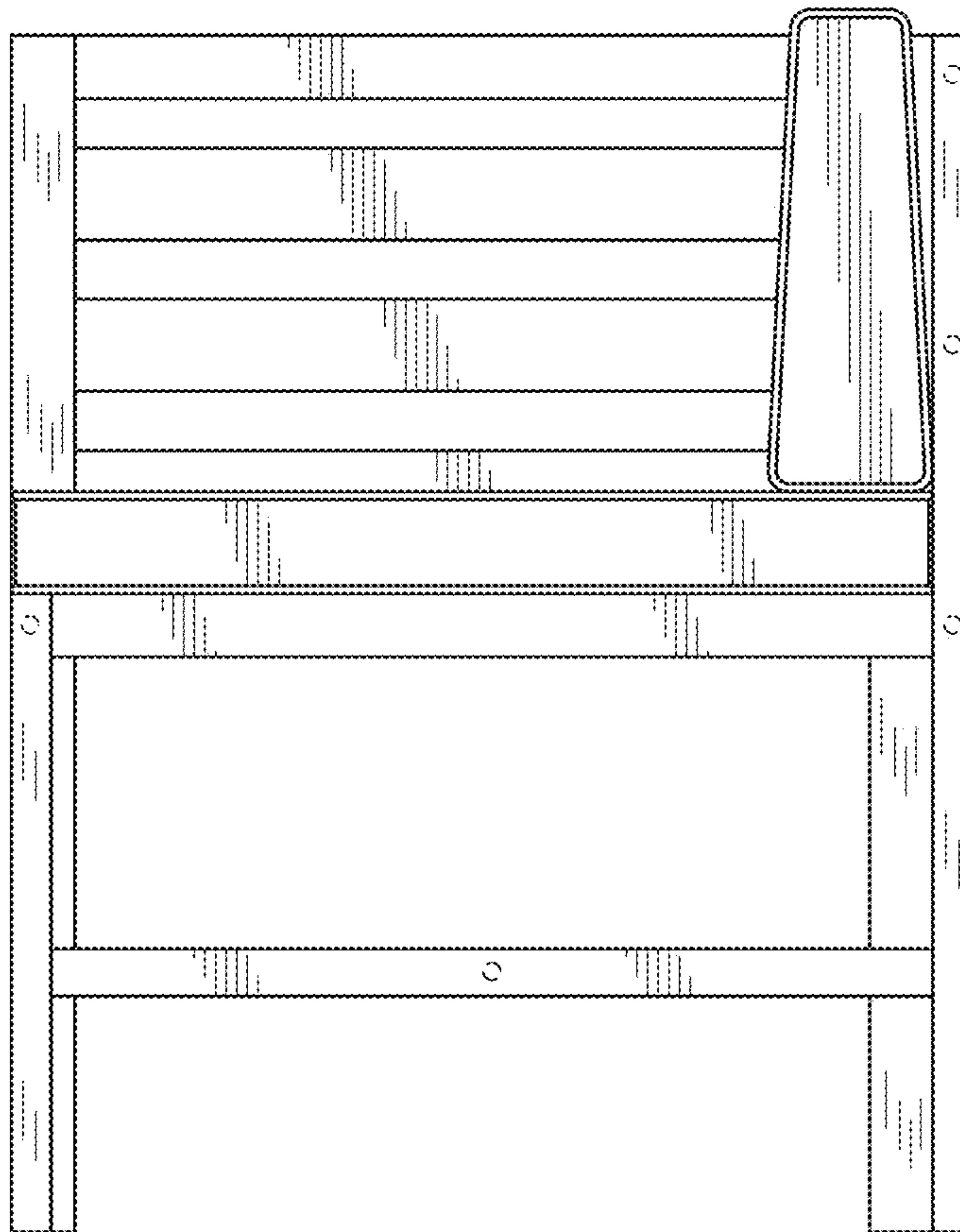
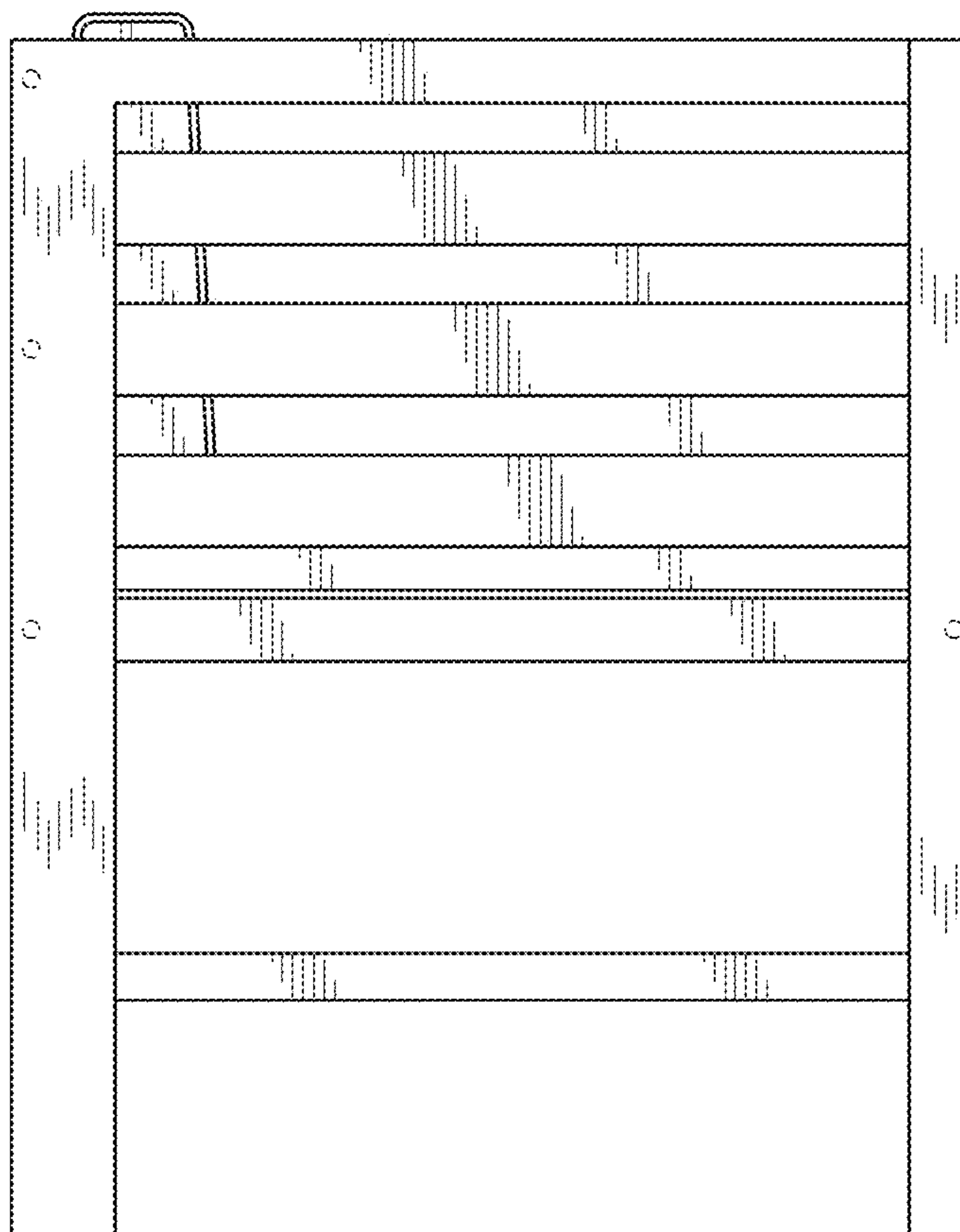

FIG. 8



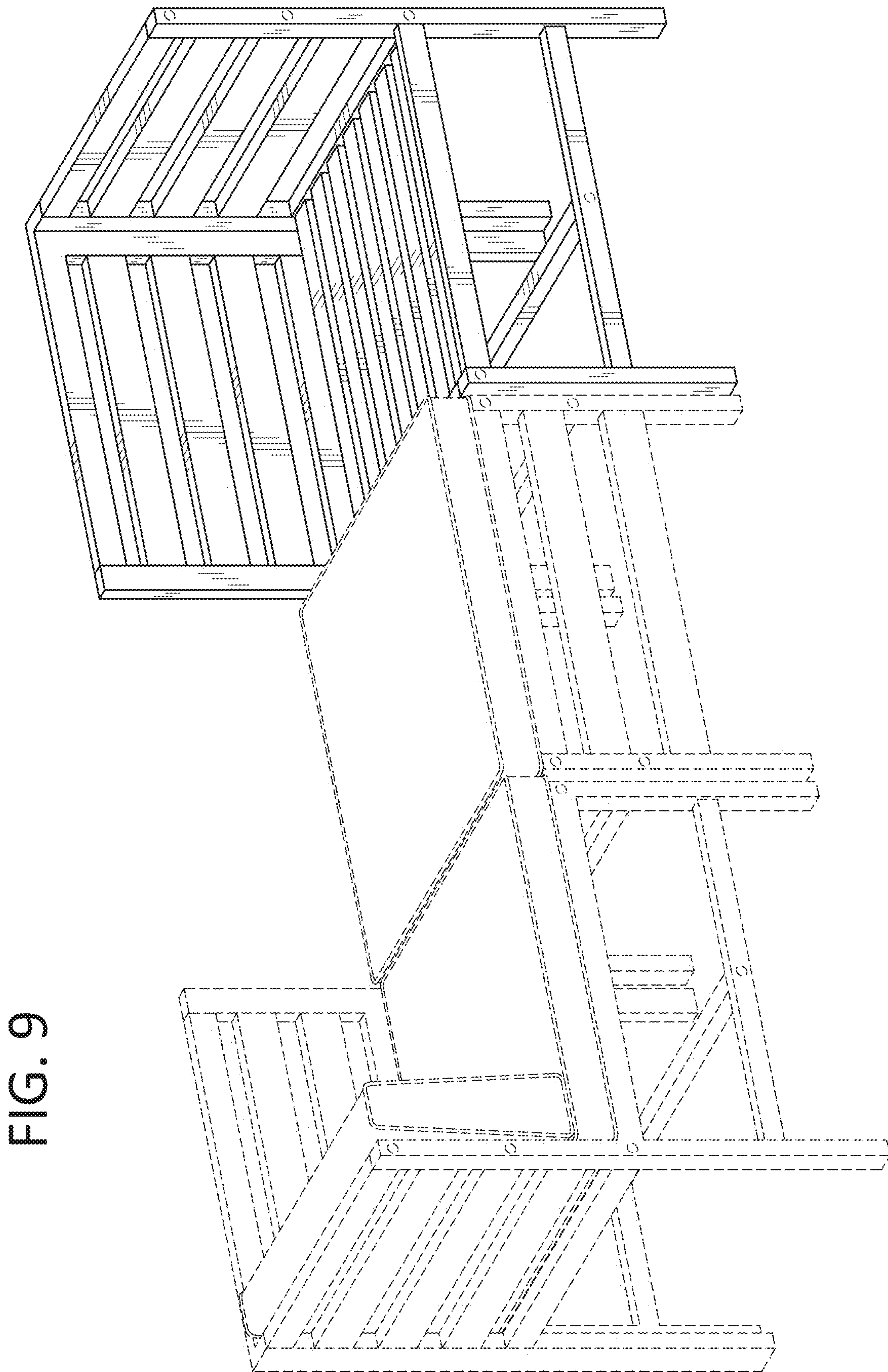

FIG. 9

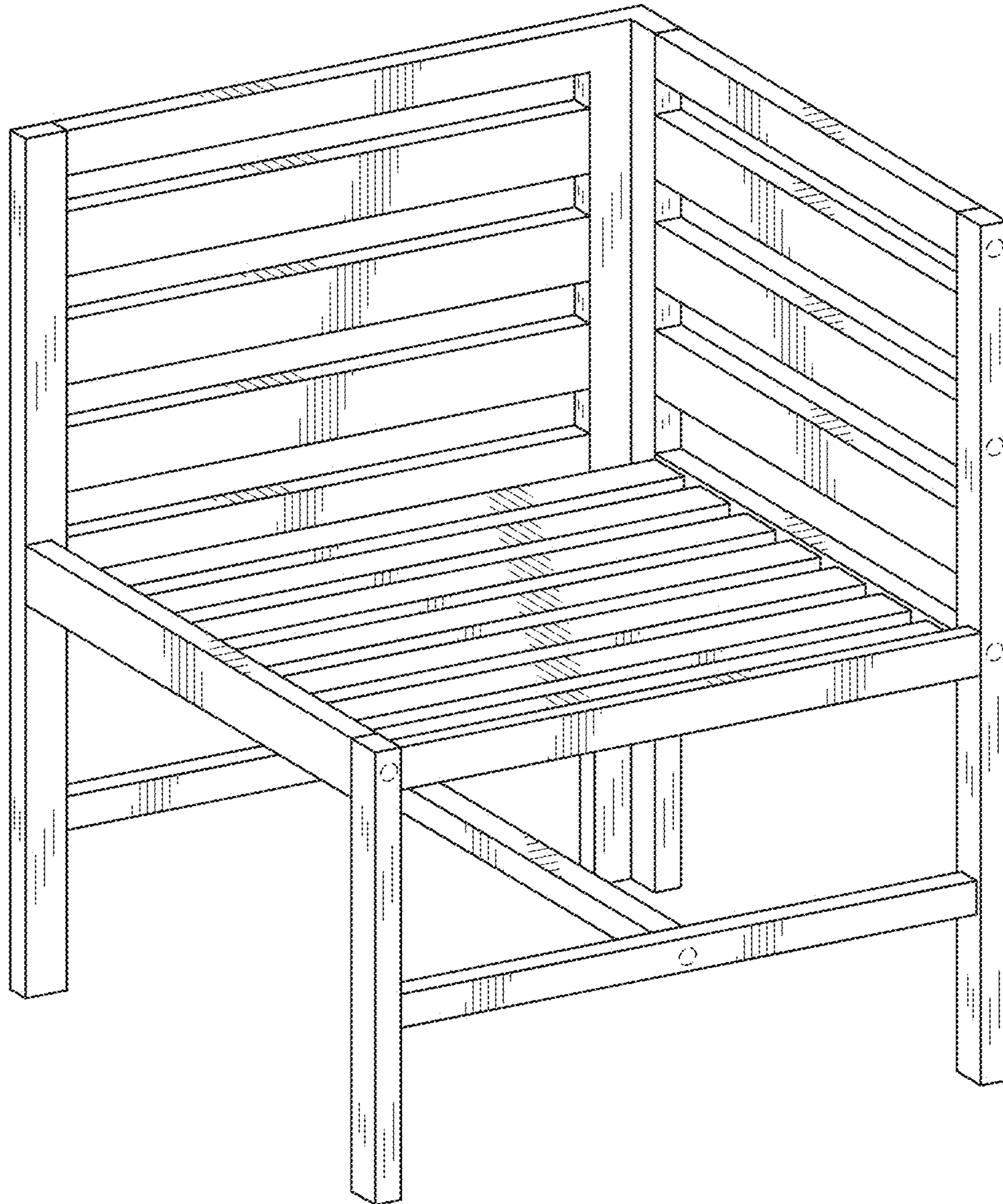

FIG. 10

FIG. 11

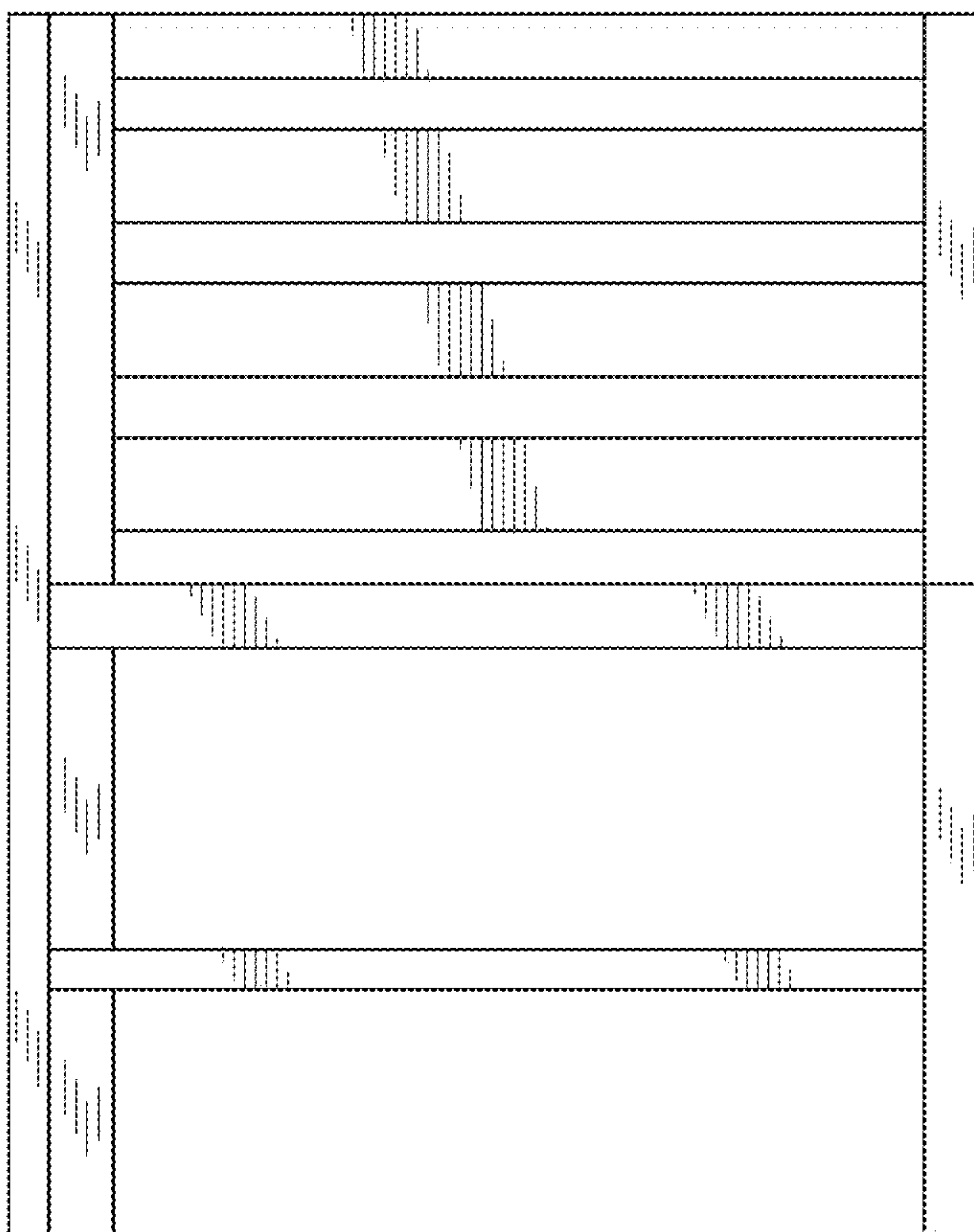
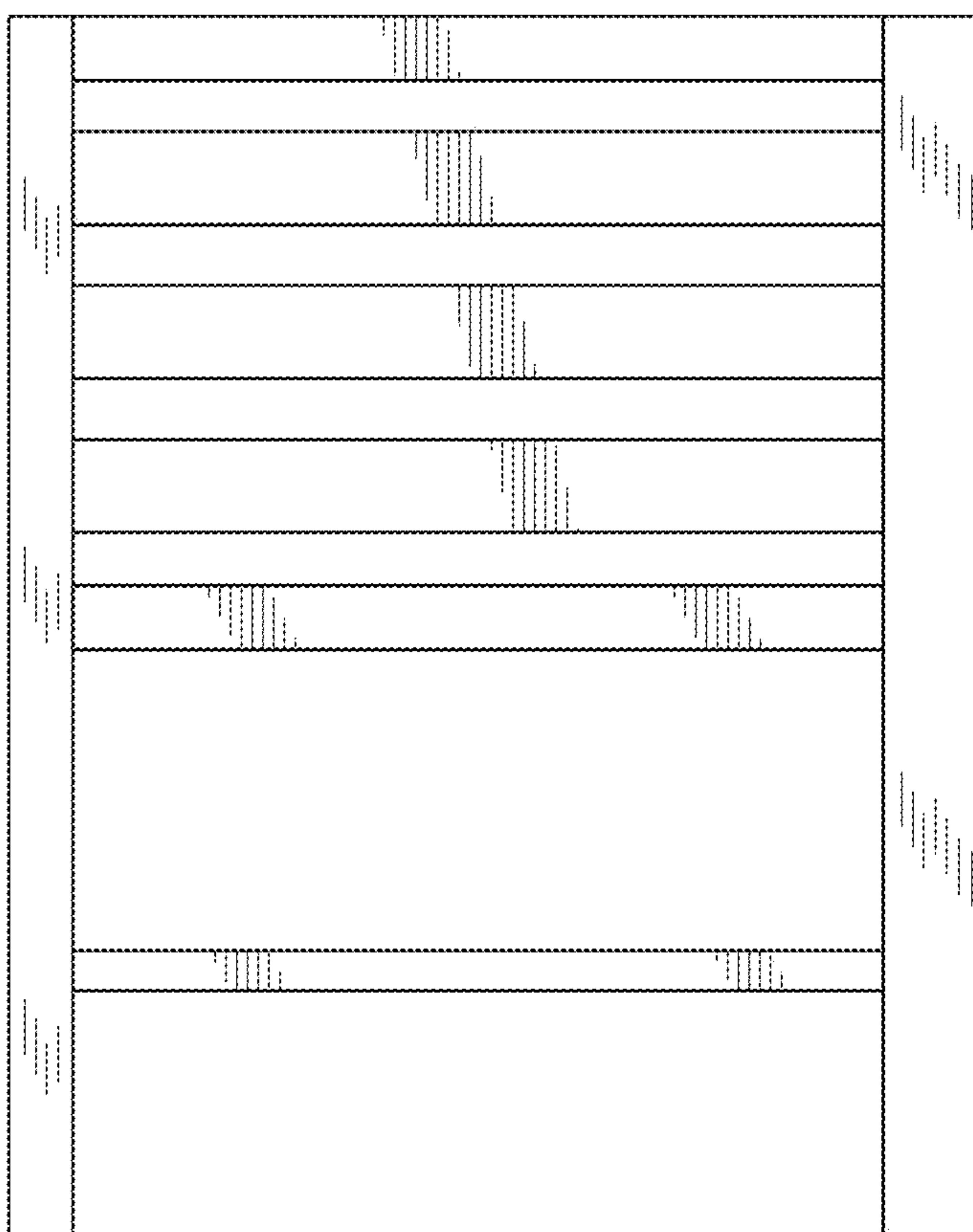

FIG. 12



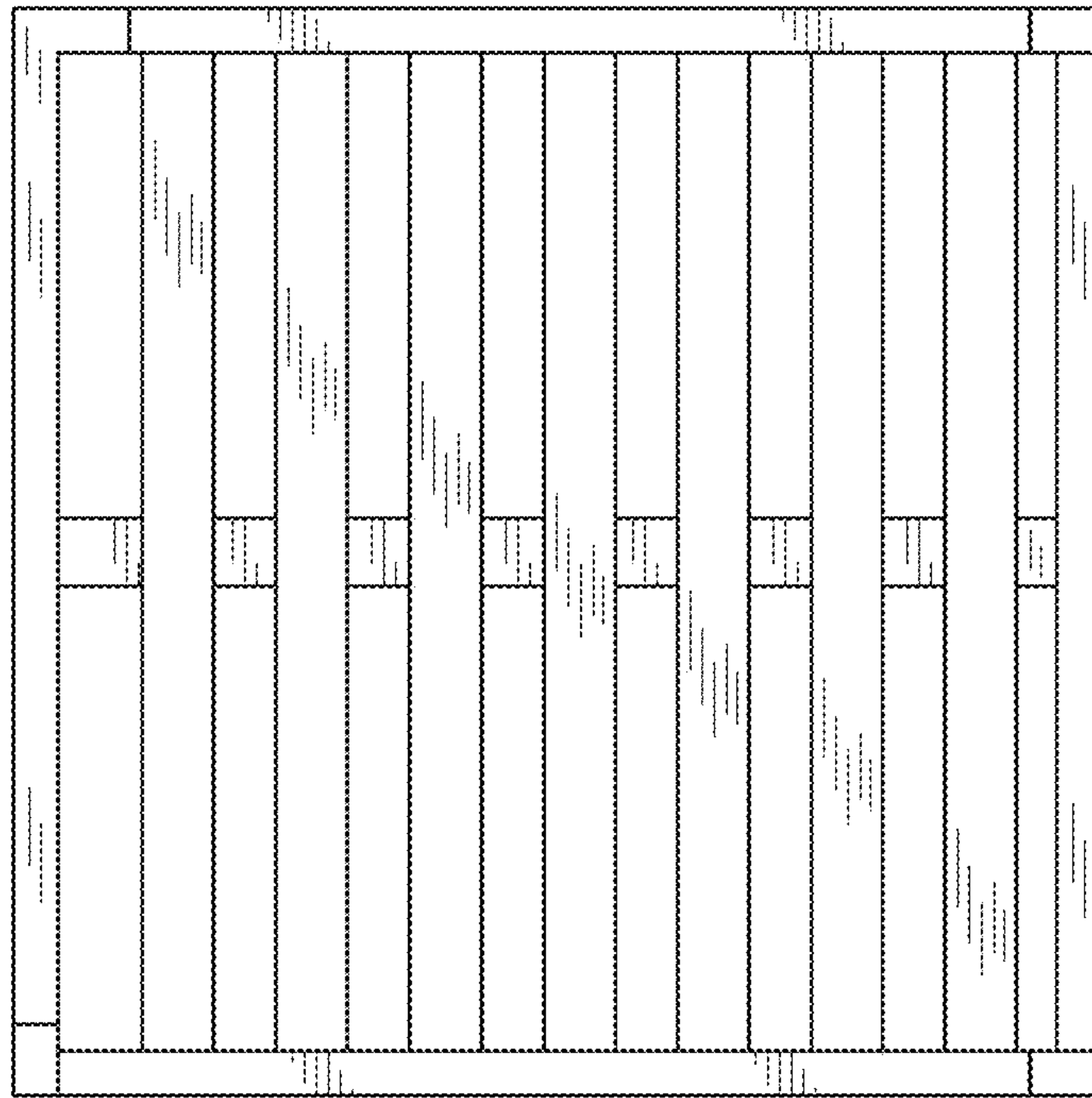

FIG. 13

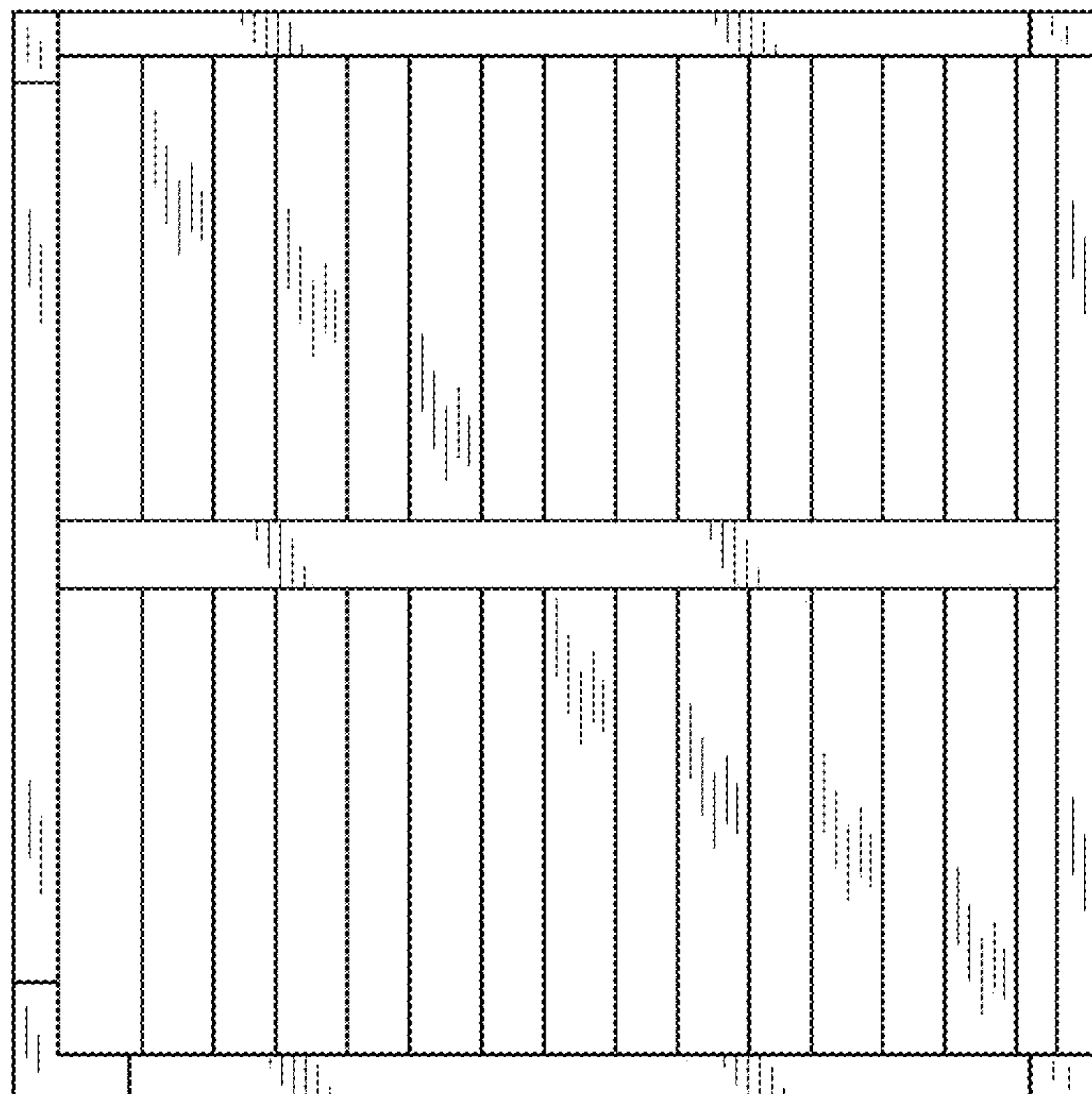

FIG. 14

FIG. 15

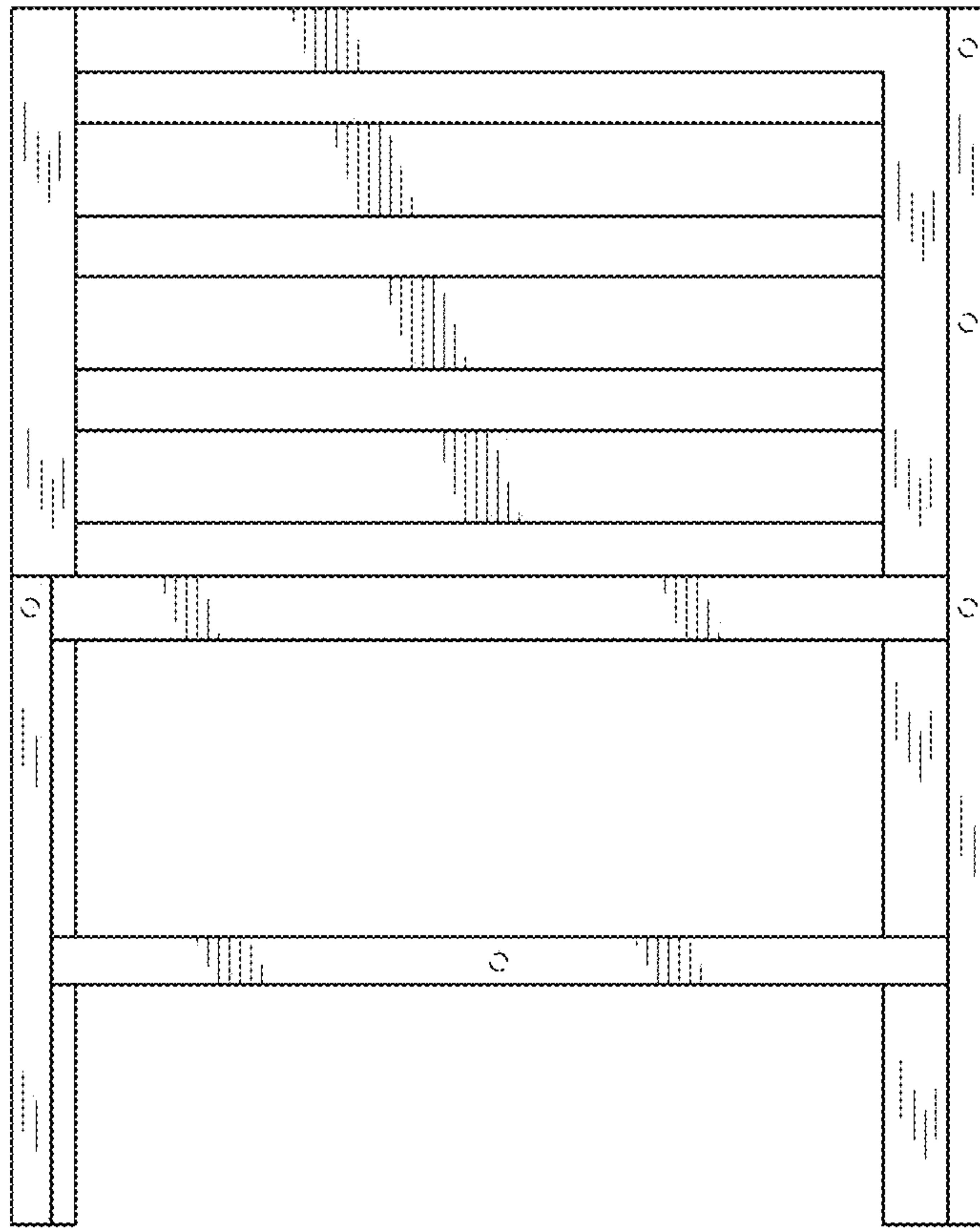

FIG. 16

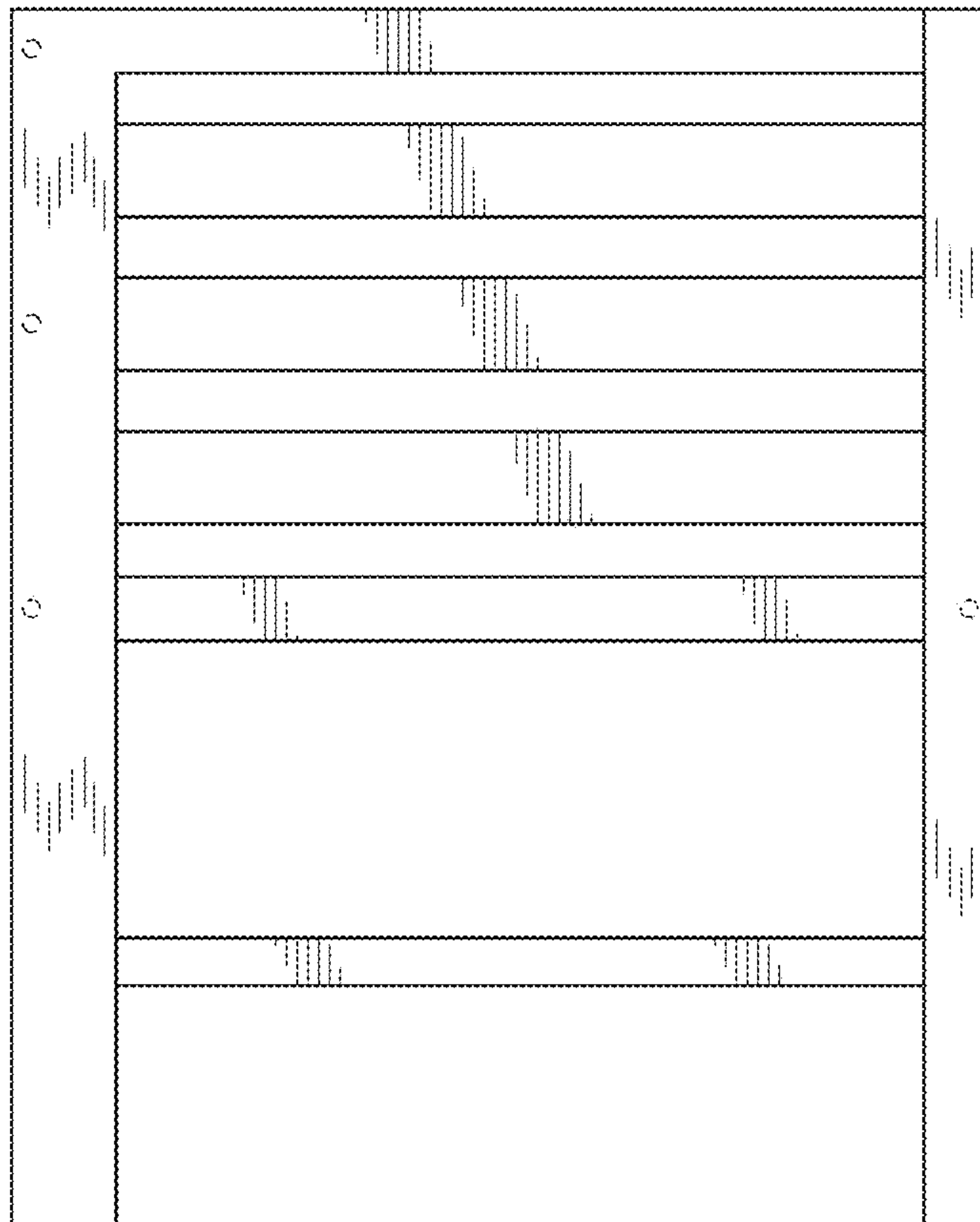
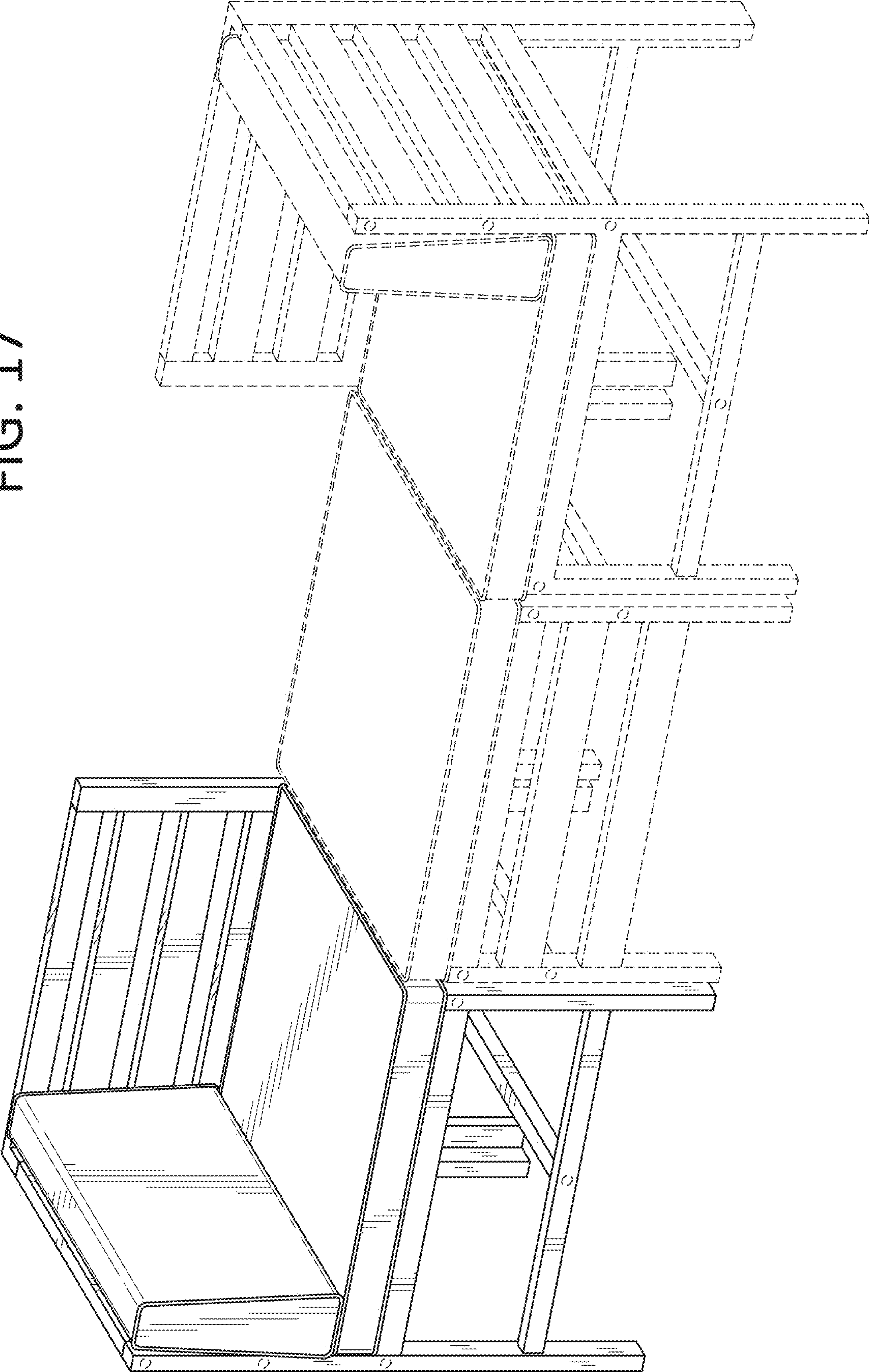

FIG. 17



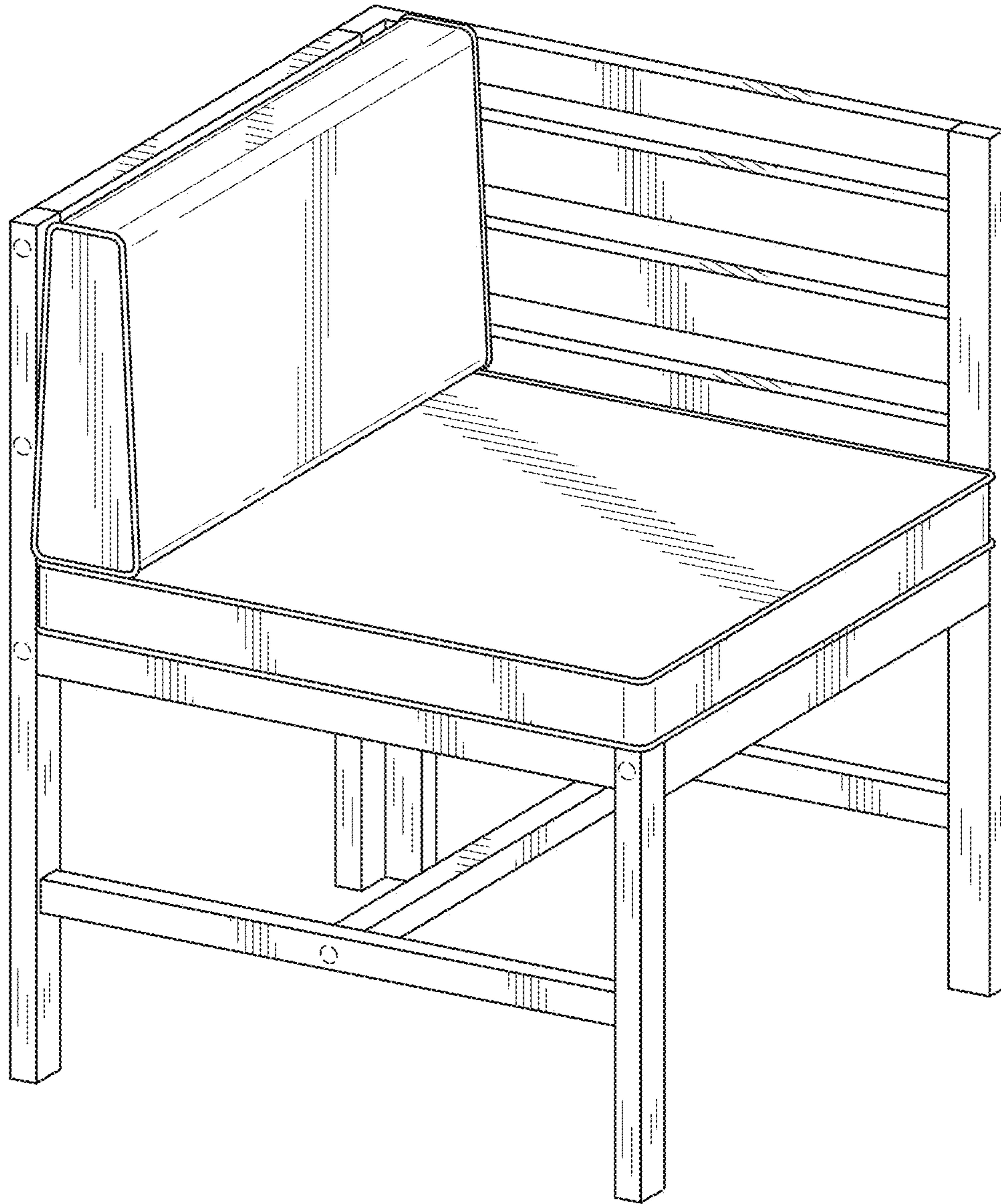

FIG. 18

FIG. 19

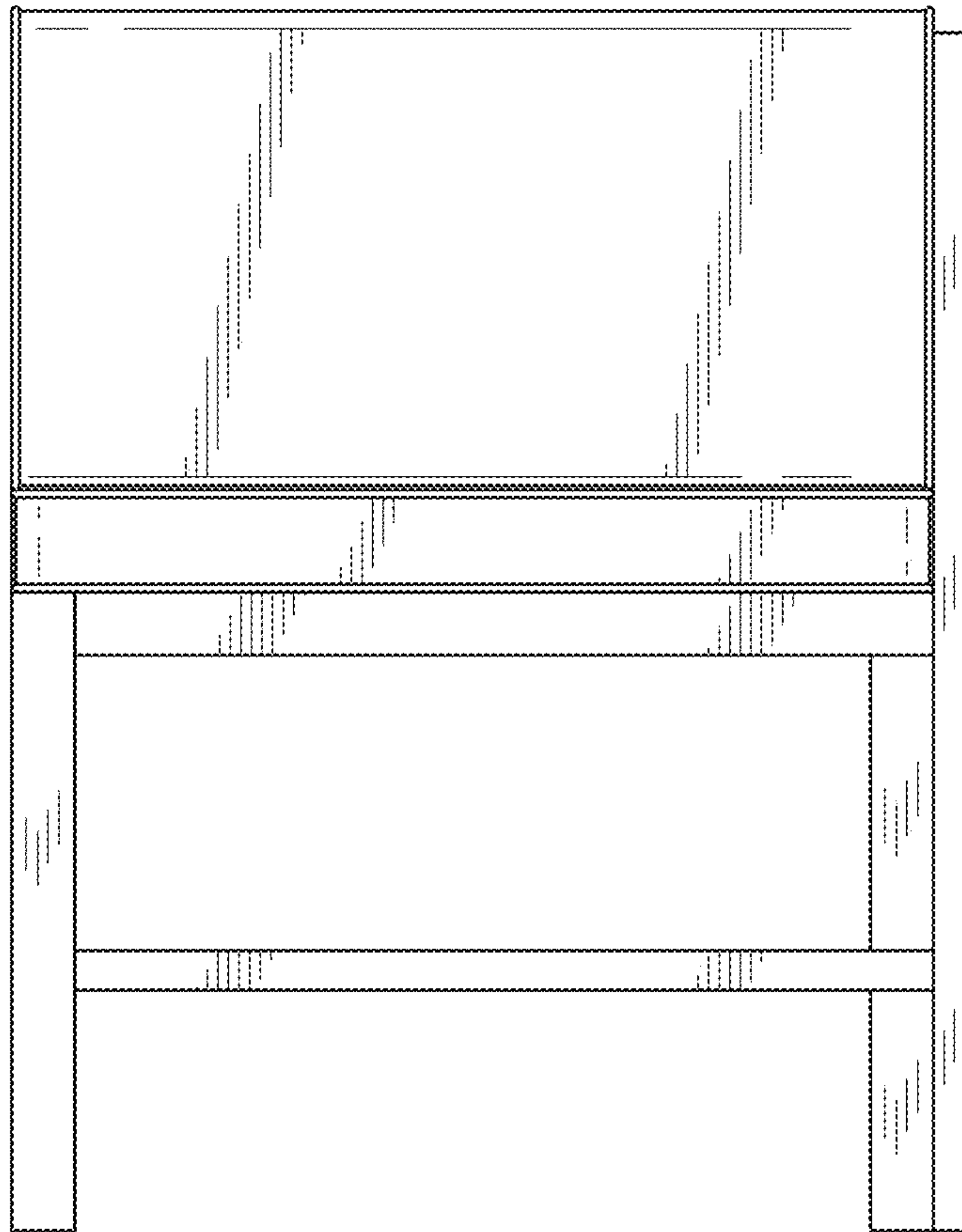
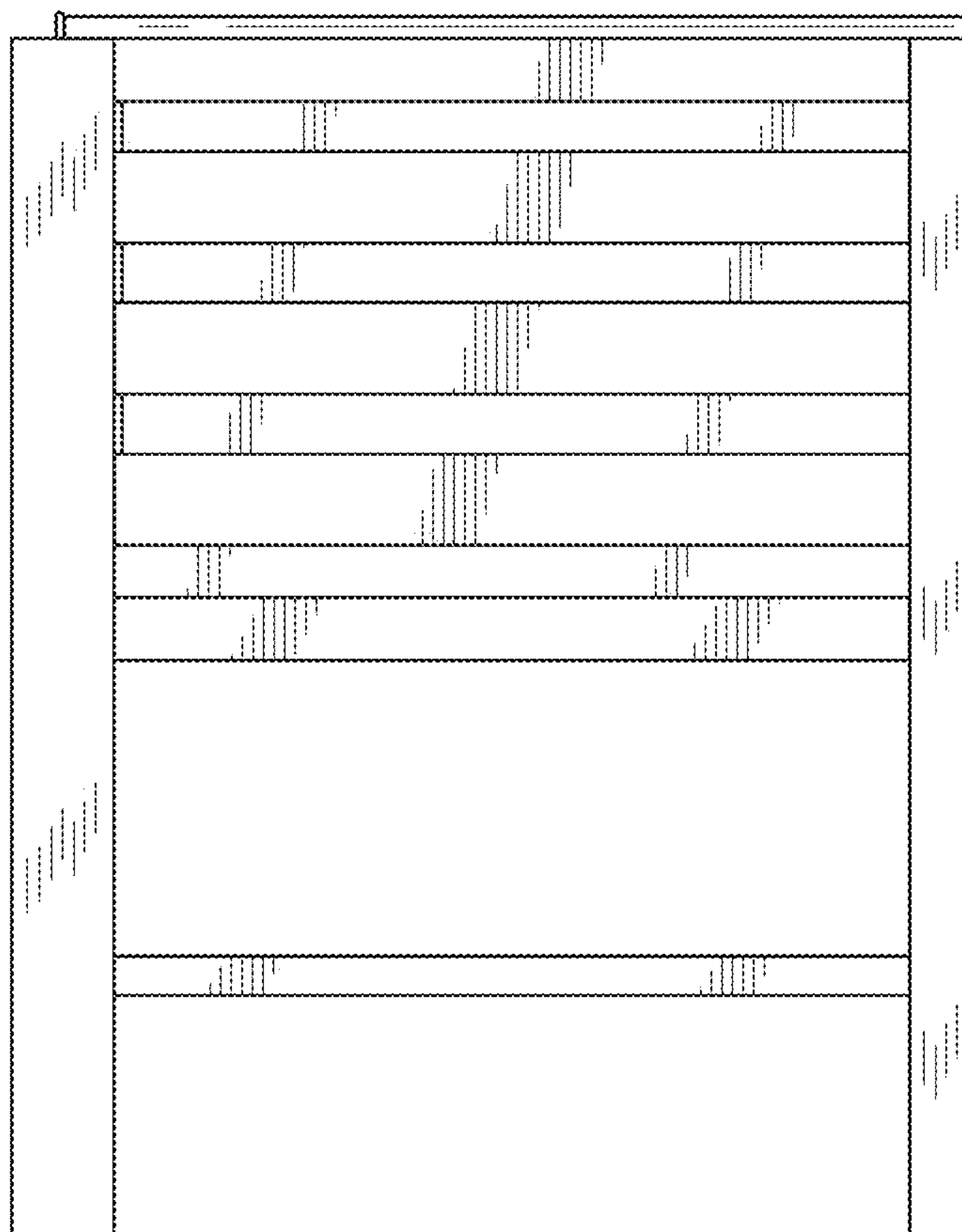

FIG. 20



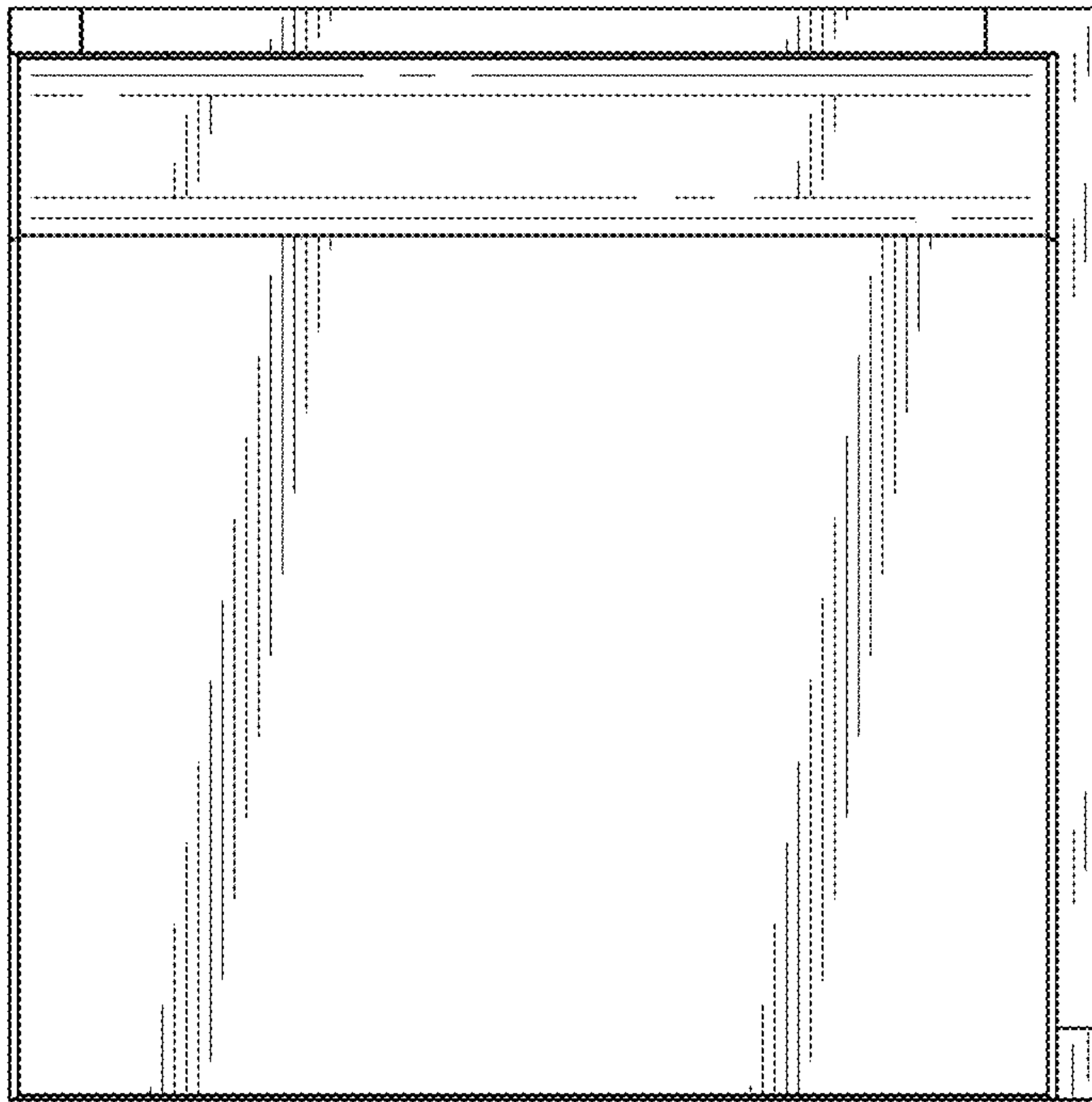

FIG. 21

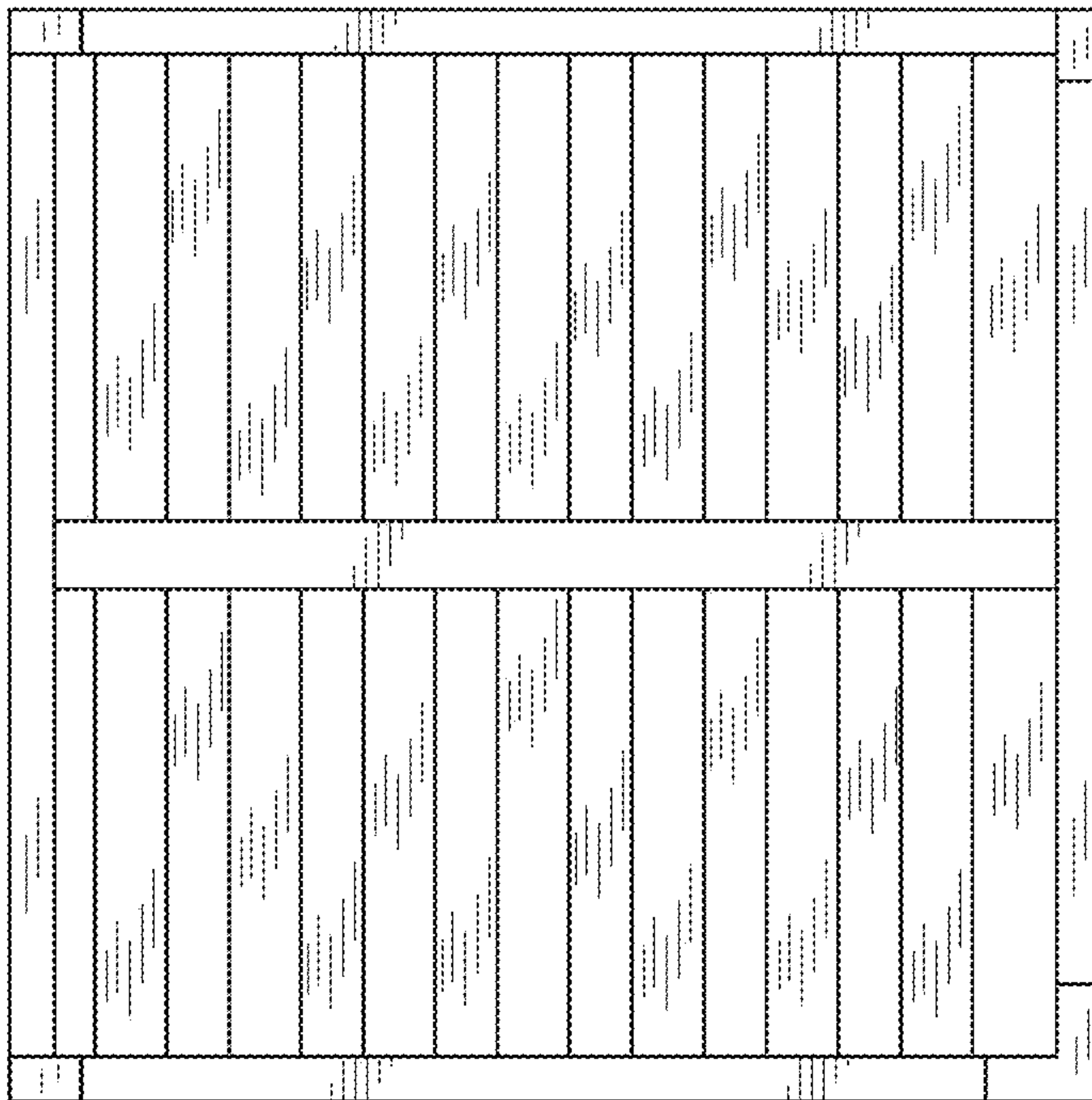

FIG. 22

FIG. 23

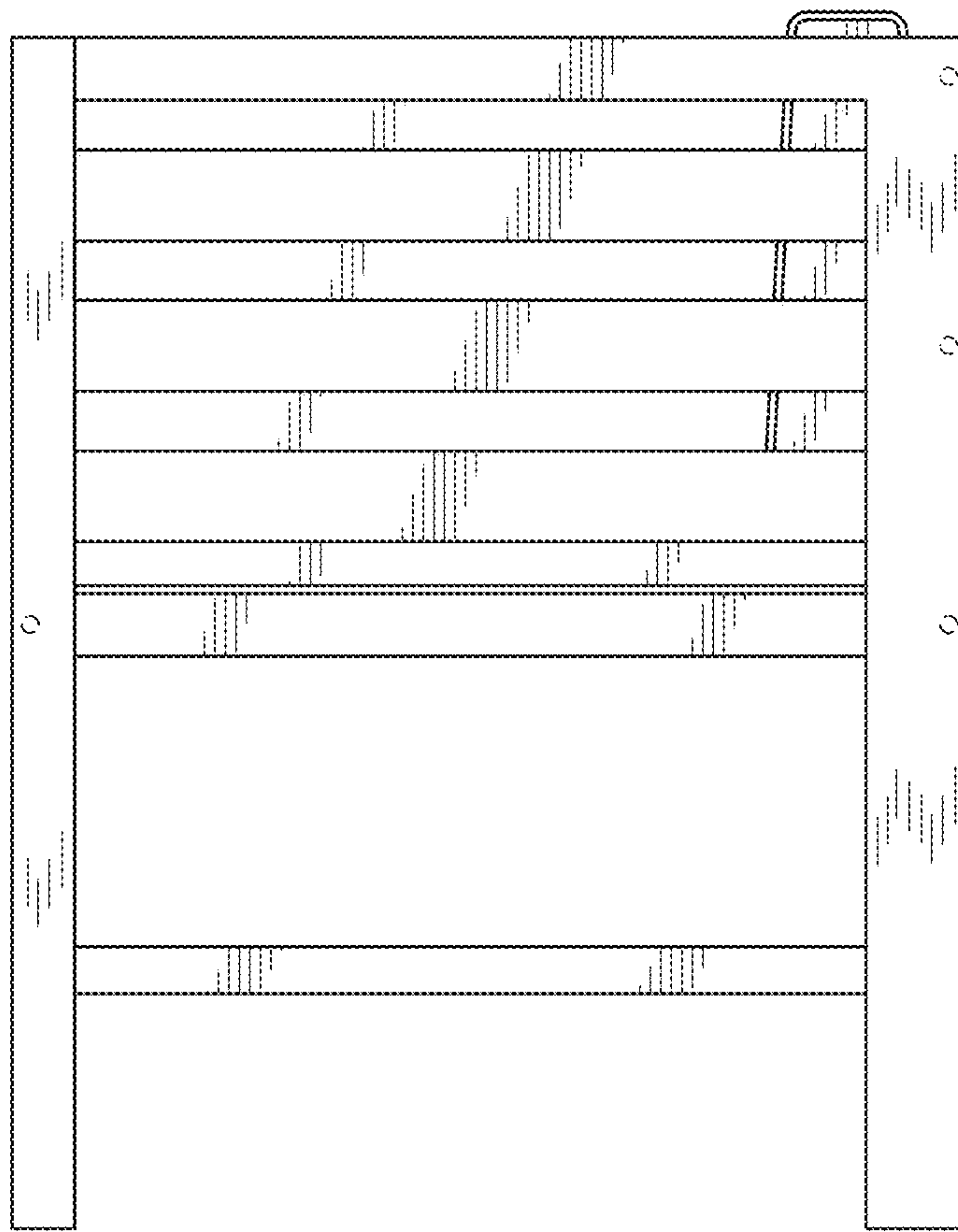

FIG. 24

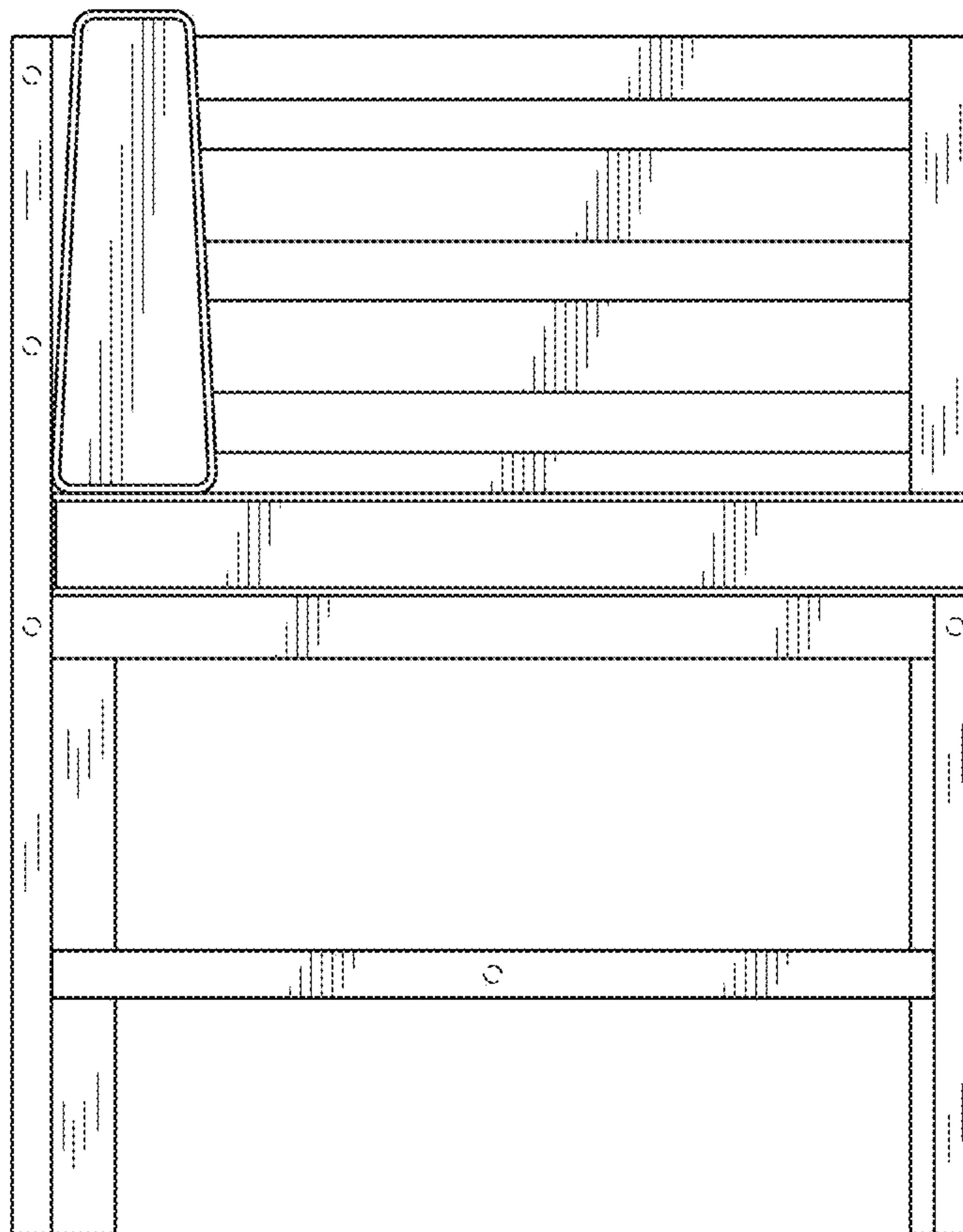
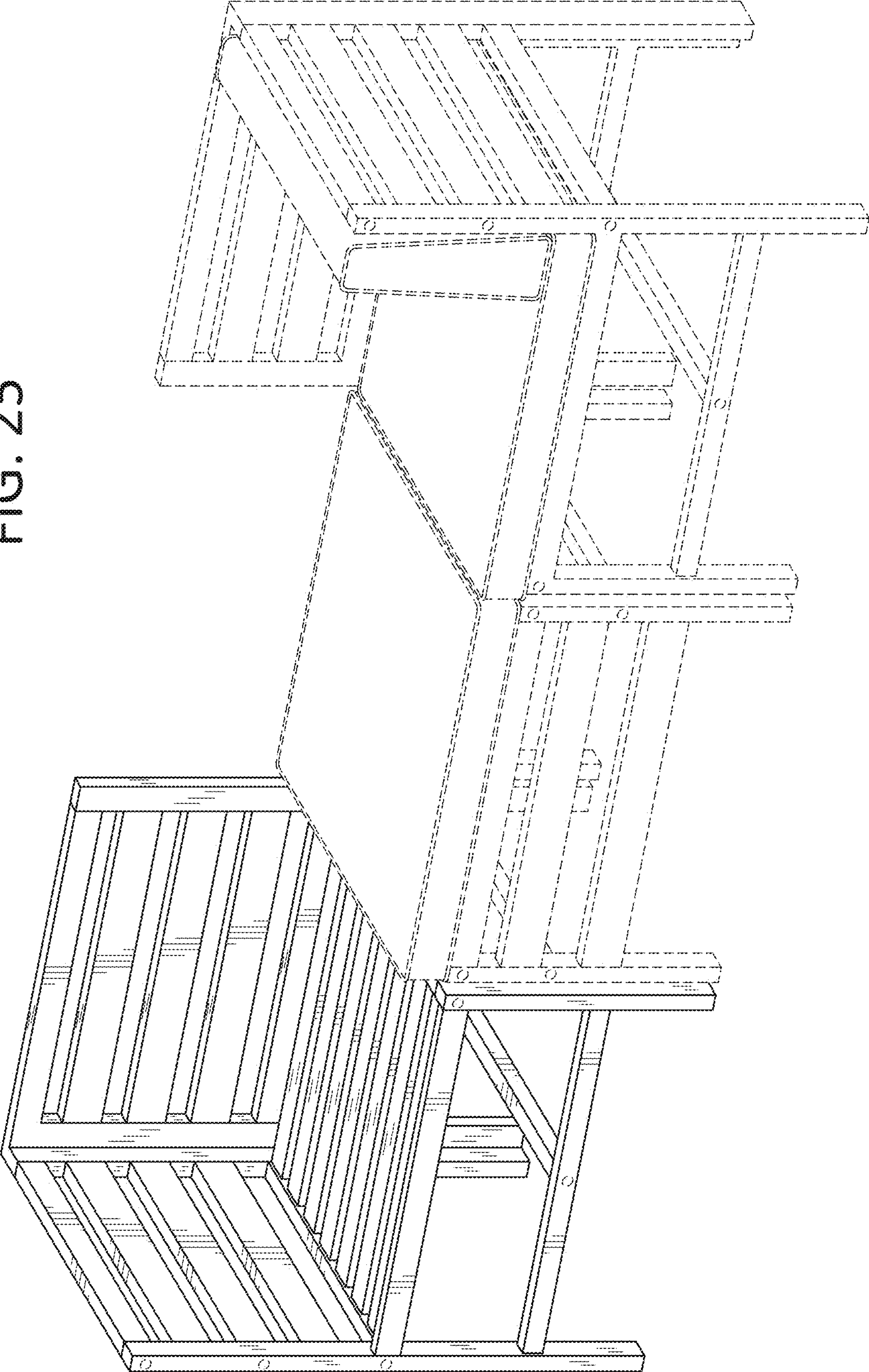

FIG. 25



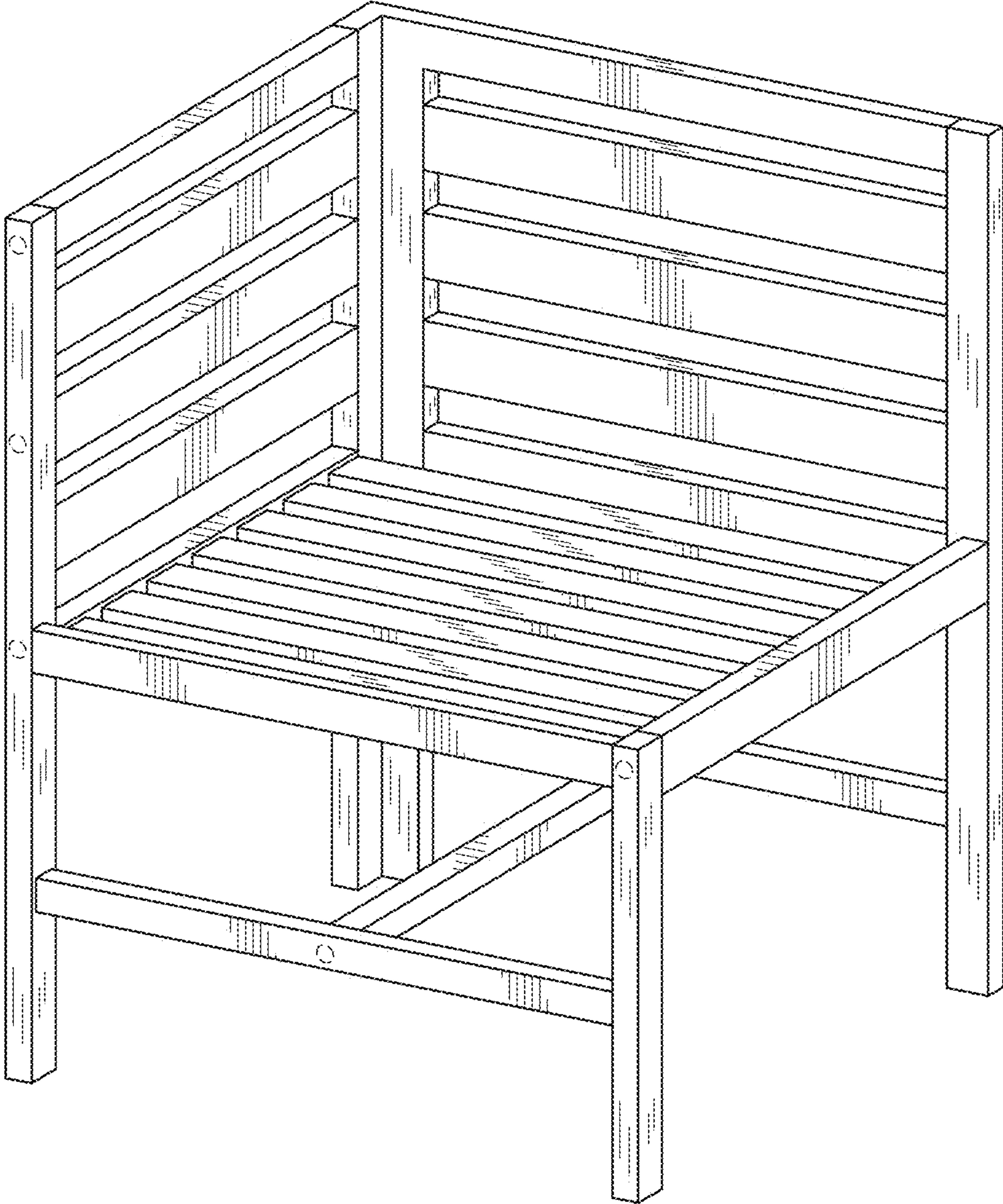

FIG. 26

FIG. 27

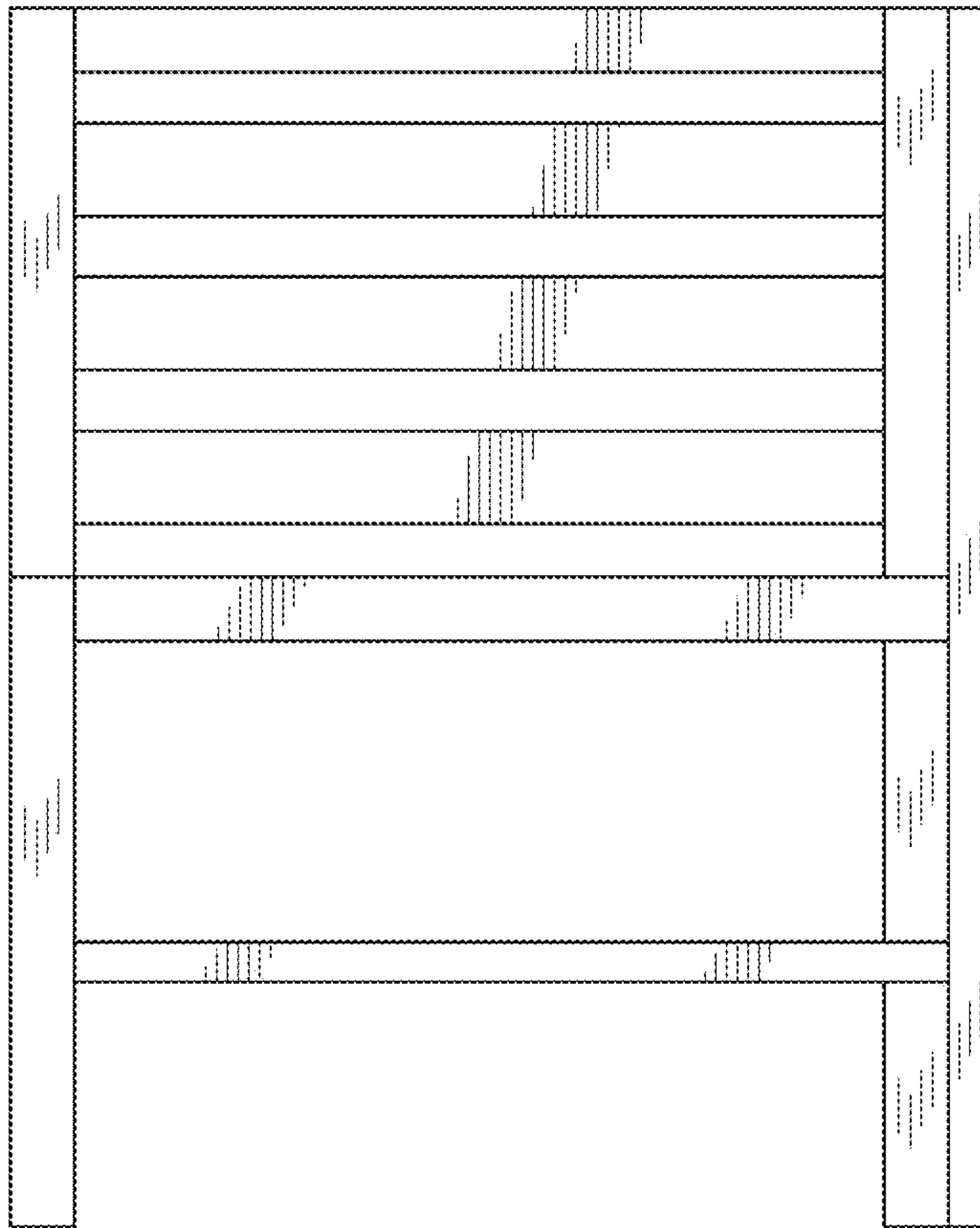
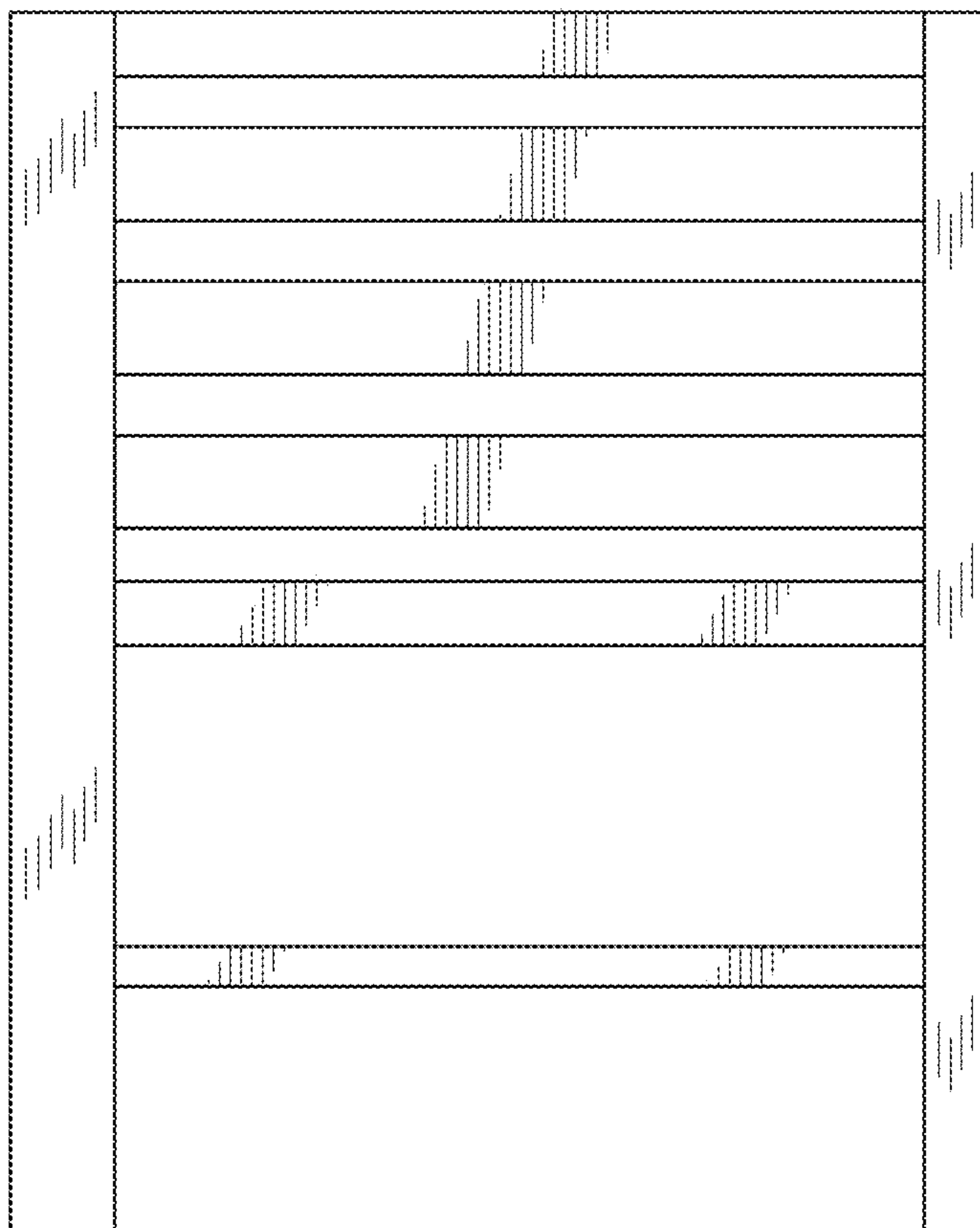

FIG. 28



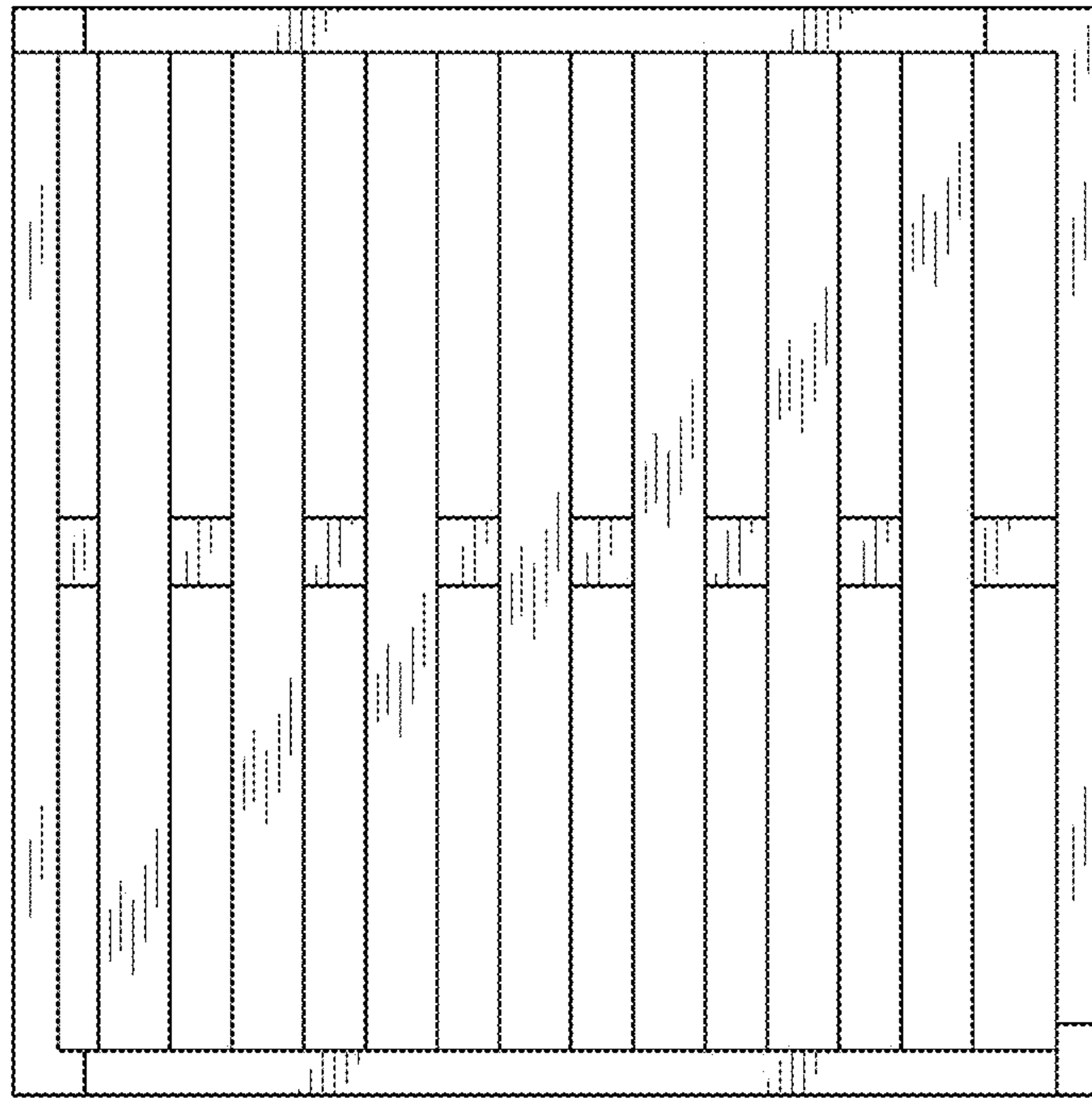

FIG. 29

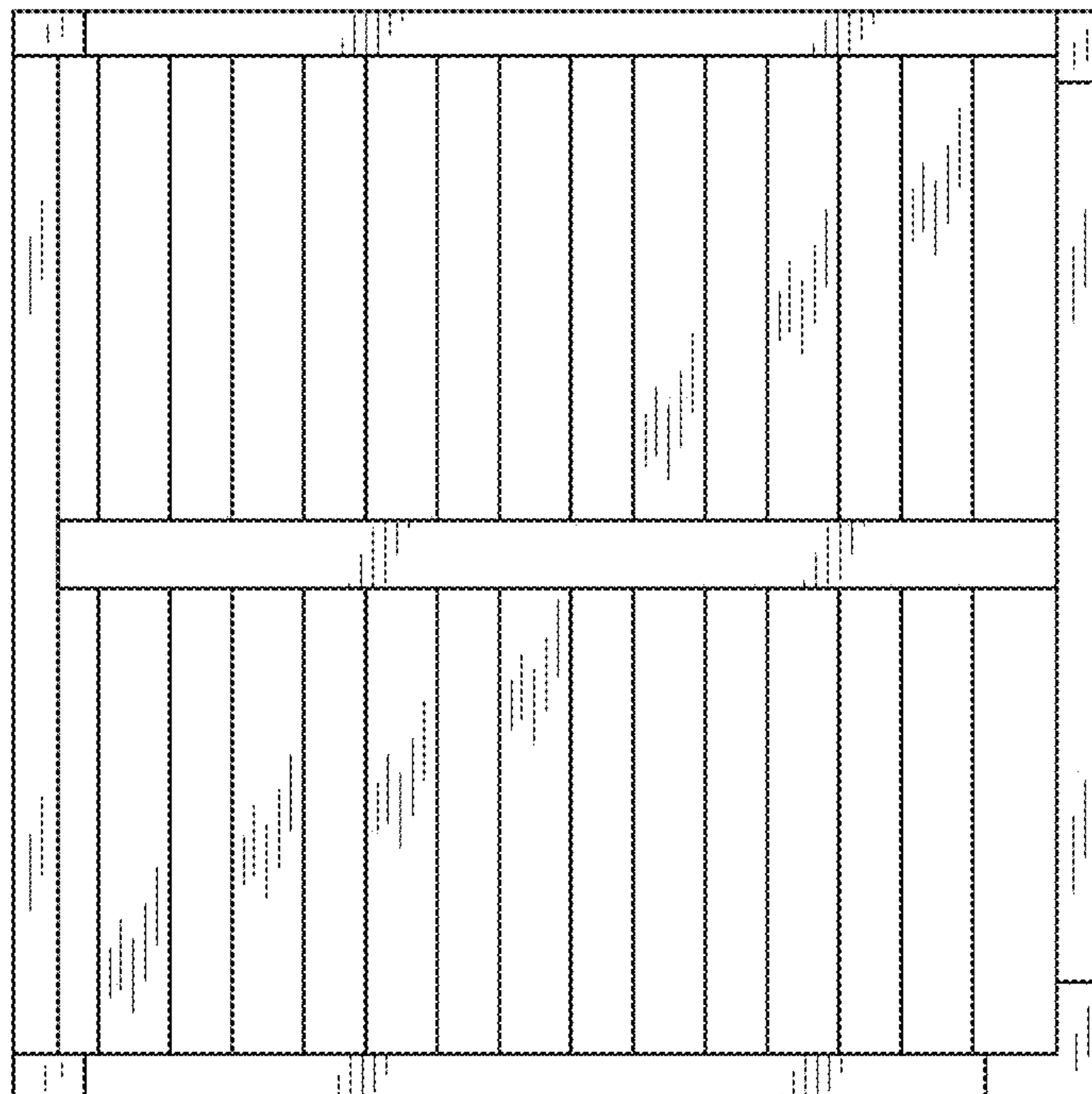

FIG. 30

FIG. 31

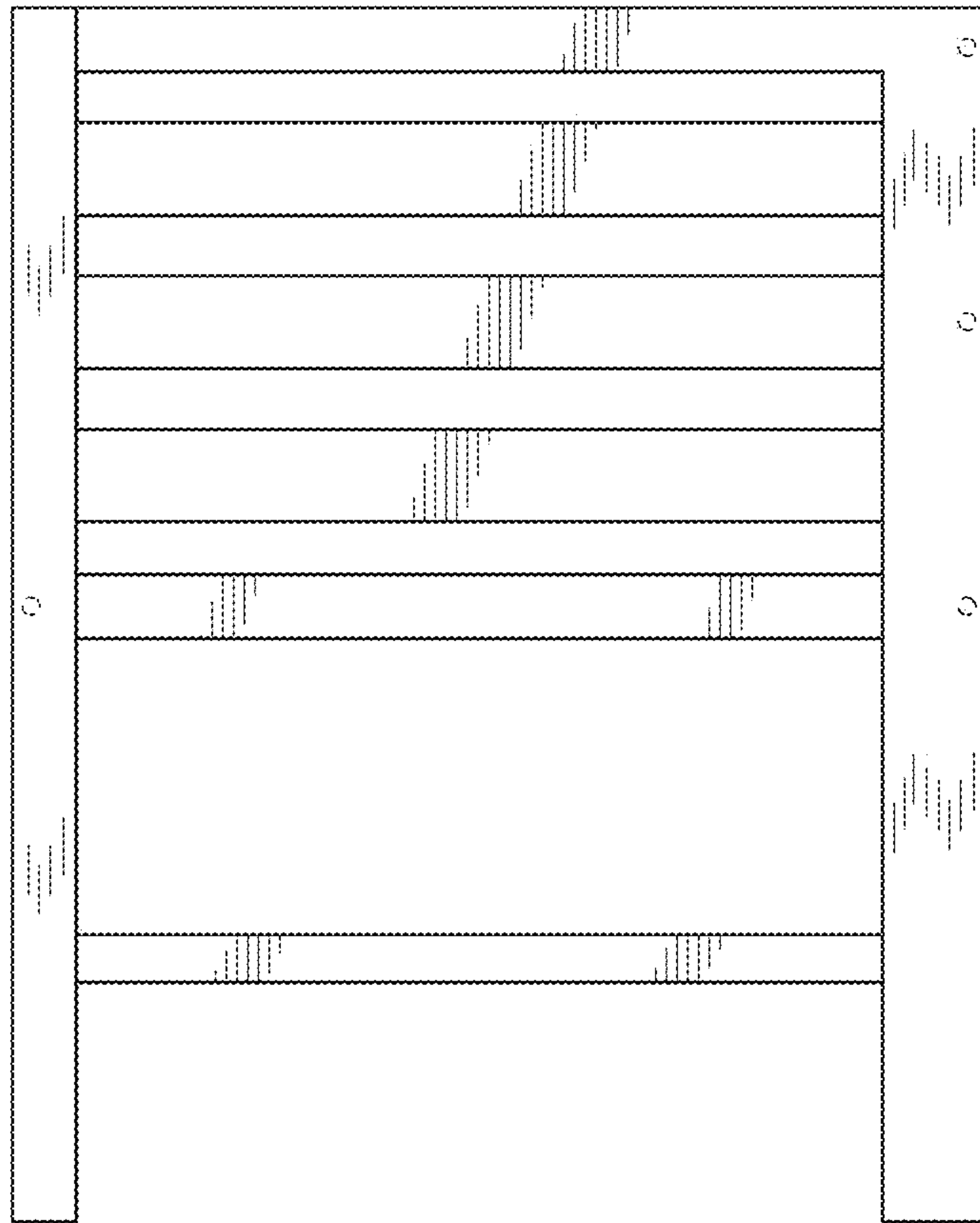

FIG. 32

