



US00D918604S

(12) **United States Design Patent**  
**Jones**

(10) **Patent No.:** **US D918,604 S**

(45) **Date of Patent:** **\*\* May 11, 2021**

(54) **GARMENT HANGER**

(71) Applicant: **Mainetti (UK) Ltd**, Roxburghshire  
(GB)

(72) Inventor: **Michael Edward Jones**, Denbighshire  
(GB)

(73) Assignee: **Mainetti (UK) Ltd**

(\*\*) Term: **15 Years**

(21) Appl. No.: **29/715,442**

(22) Filed: **Dec. 2, 2019**

(51) **LOC (13) Cl.** ..... **06-08**

(52) **U.S. Cl.**  
USPC ..... **D6/315; D6/328**

(58) **Field of Classification Search**  
USPC ..... D6/315–328  
CPC ..... A47G 25/28; A47G 25/14; A47G 25/36;  
A47G 25/48; A47G 25/66; A47G 25/441;  
A47G 25/481; A47G 25/483; A47G  
25/485; A47G 25/487; A47G 25/621;  
A47G 25/743; A47F 5/0006  
See application file for complete search history.

(56) **References Cited**

**U.S. PATENT DOCUMENTS**

D301,808 S \* 6/1989 Marshall ..... D6/326  
5,992,714 A \* 11/1999 Morgan ..... A47G 25/485  
223/96

D466,311 S \* 12/2002 Hawkins ..... D6/326  
D466,705 S \* 12/2002 Hawkins ..... D6/326  
D531,823 S \* 11/2006 Mainetti ..... D6/326  
D586,568 S \* 2/2009 Jones ..... D6/326  
D605,416 S \* 12/2009 Warren ..... D6/328  
D612,619 S \* 3/2010 Gouldson ..... D6/315  
D616,652 S \* 6/2010 Warren ..... D6/326  
D628,819 S \* 12/2010 Mazzotta ..... D6/326  
D727,633 S \* 4/2015 Atkinson ..... D6/328  
D804,199 S \* 12/2017 Jones ..... D6/326

\* cited by examiner

*Primary Examiner* — Lauren R Calve

(74) *Attorney, Agent, or Firm* — The Belles Group, P.C.

(57) **CLAIM**

I claim the ornamental design for a garment hanger, as shown and described.

**DESCRIPTION**

FIG. 1 is a front perspective view of a garment hanger in accordance with the new design;  
FIG. 2 is a front view thereof;  
FIG. 3 is a rear view thereof;  
FIG. 4 is a right side view thereof;  
FIG. 5 is a left side view thereof;  
FIG. 6 is a top view thereof; and,  
FIG. 7 is a bottom view thereof.

The broken lines in the drawings illustrate portions of the garment hanger that form no part of the claimed design. The claimed design is not limited to the gray color shown in the drawings.

**1 Claim, 5 Drawing Sheets**

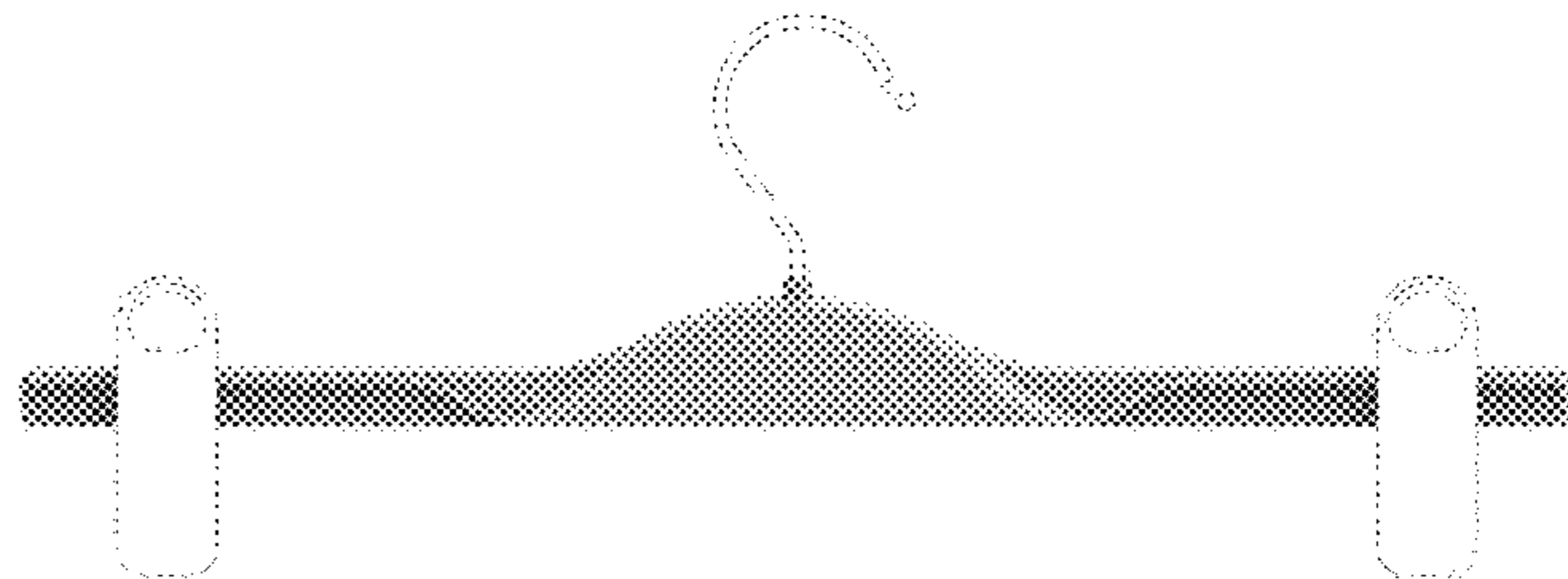
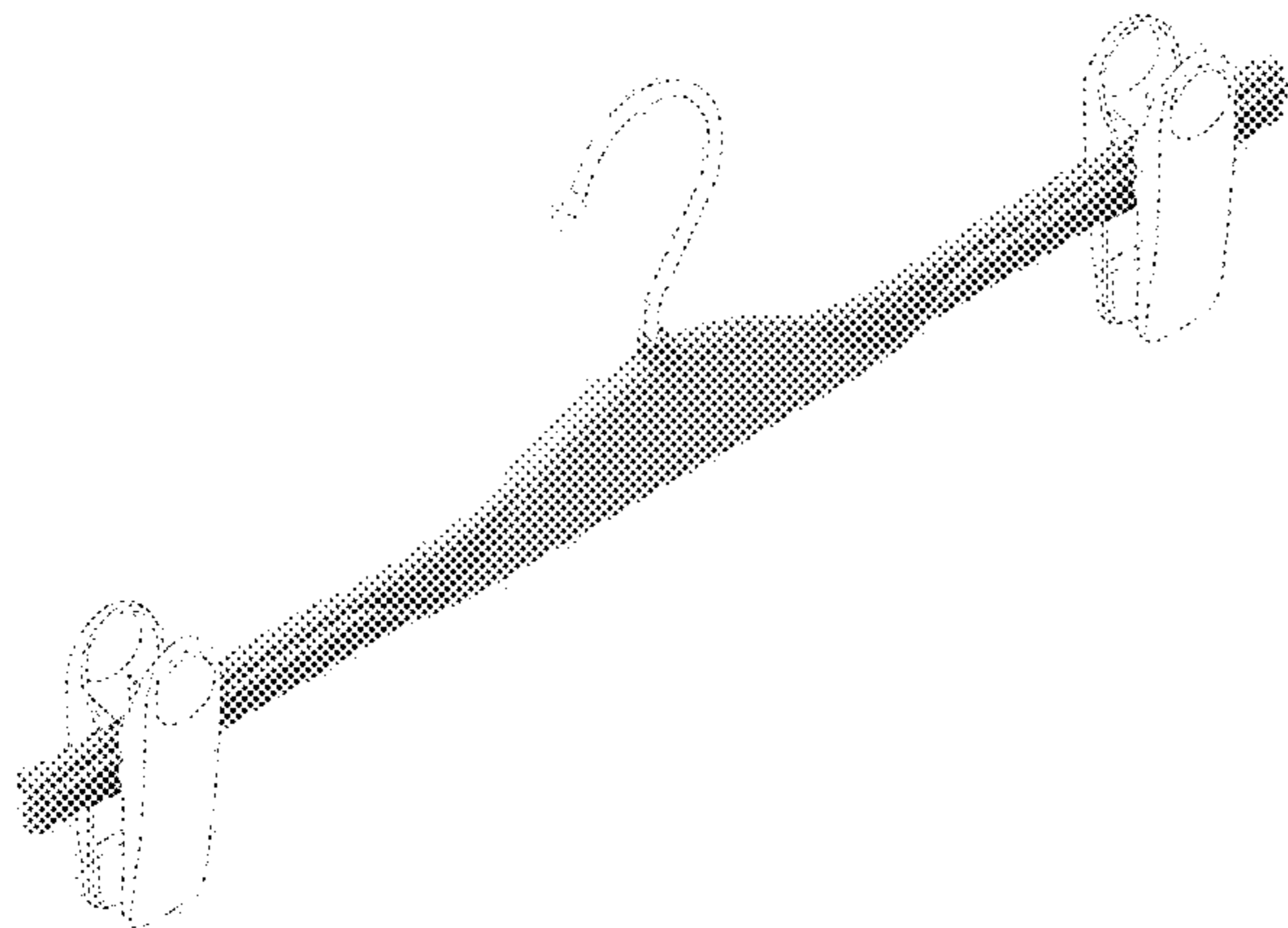

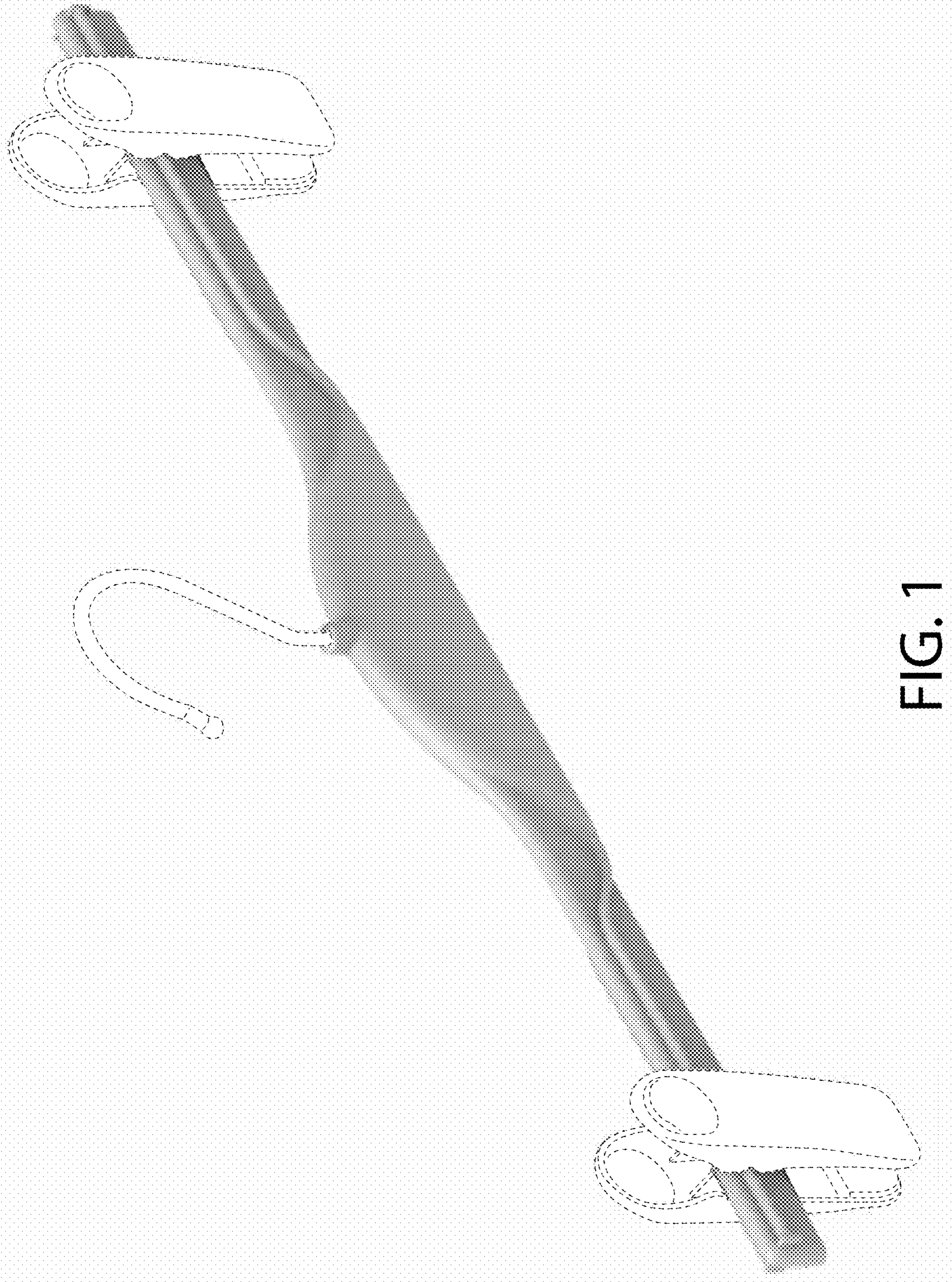

FIG. 1

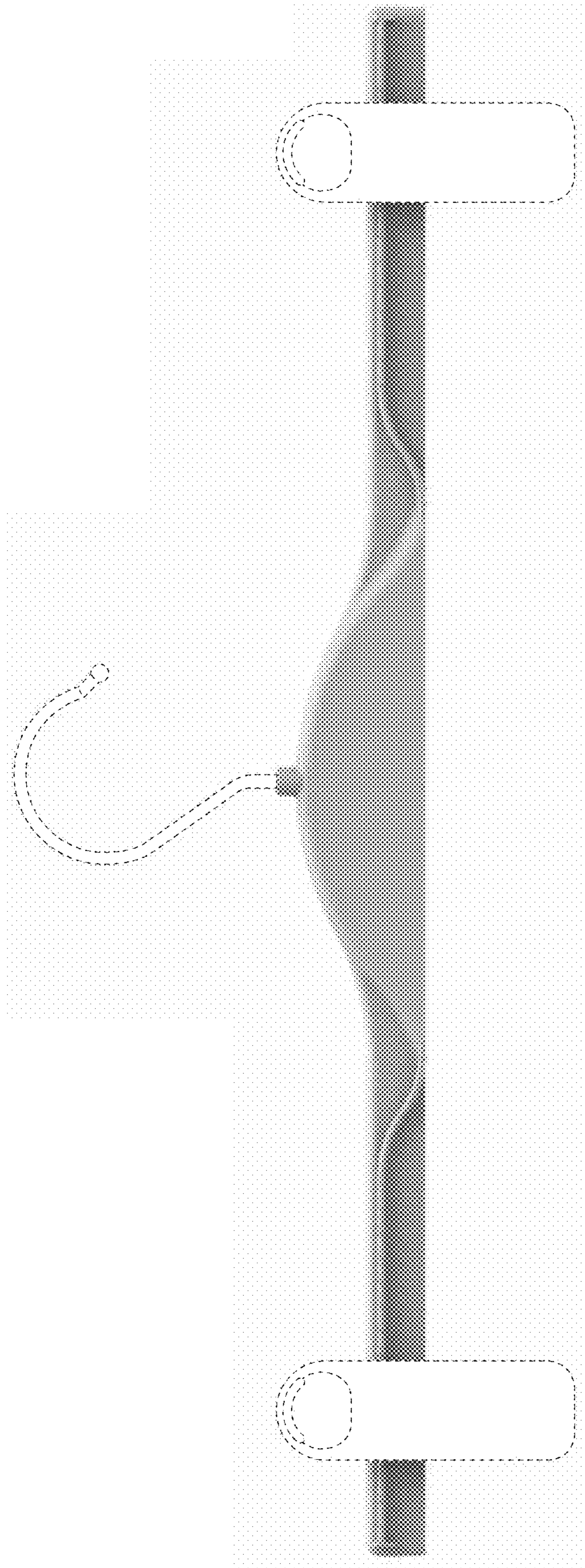

FIG. 2

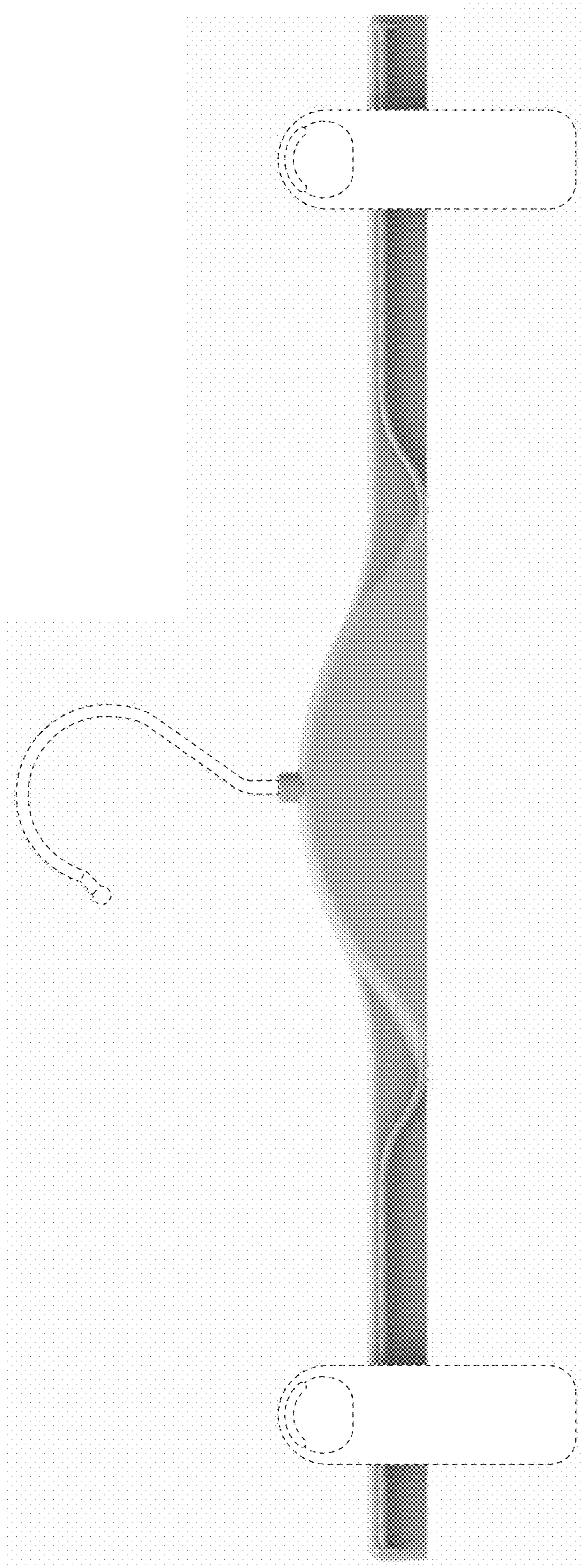

FIG. 3

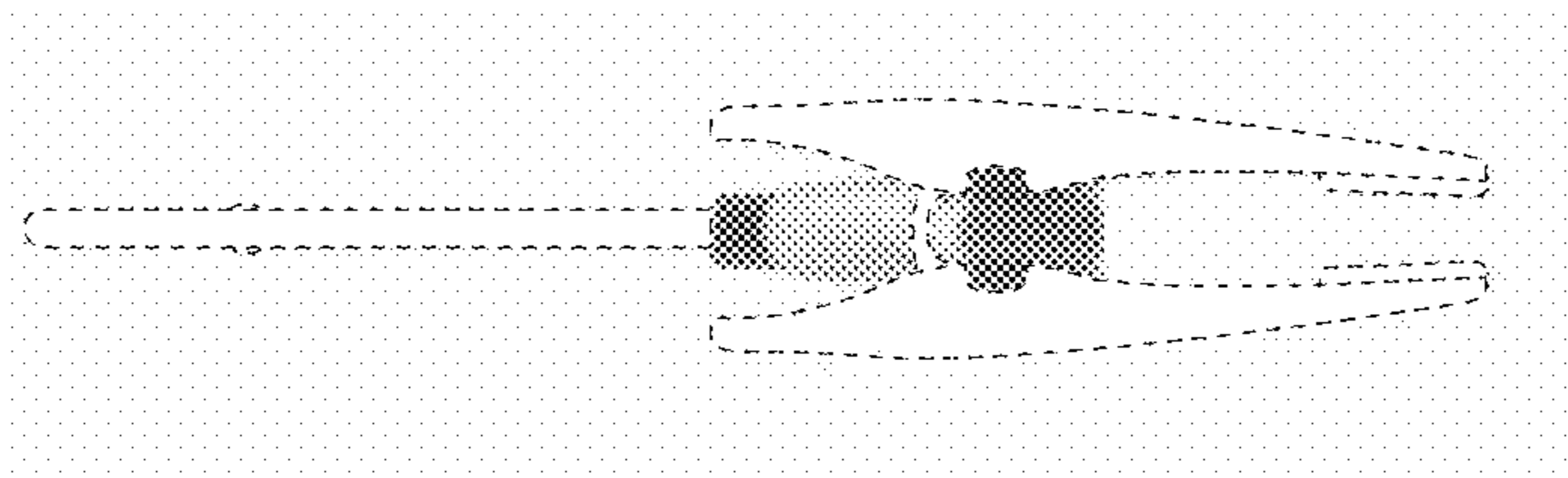

FIG. 5

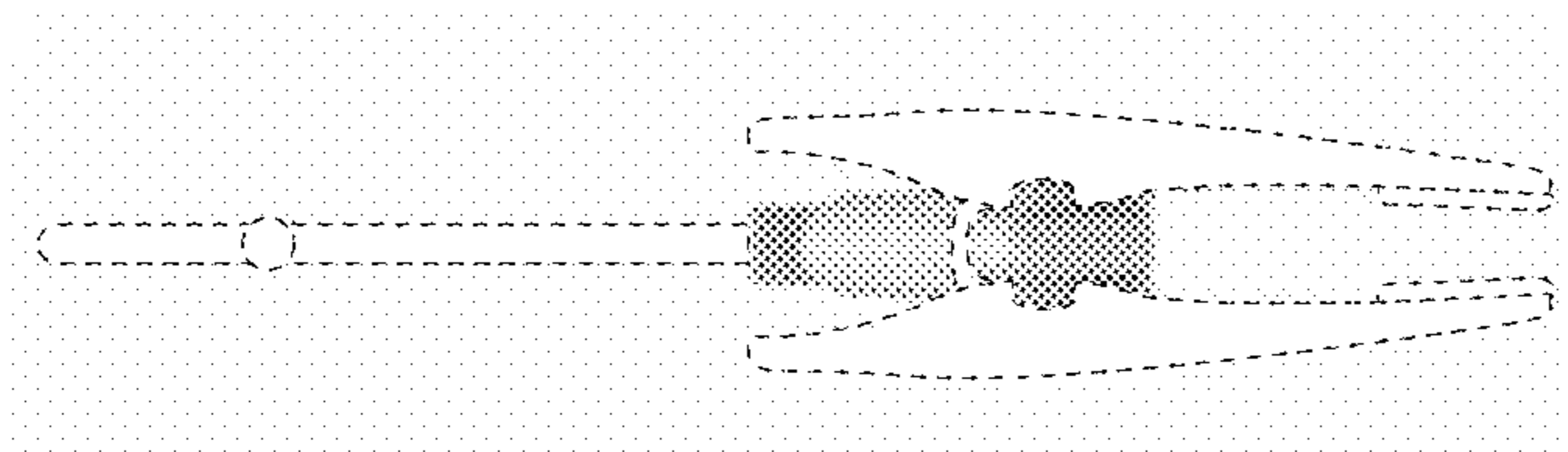

FIG. 4

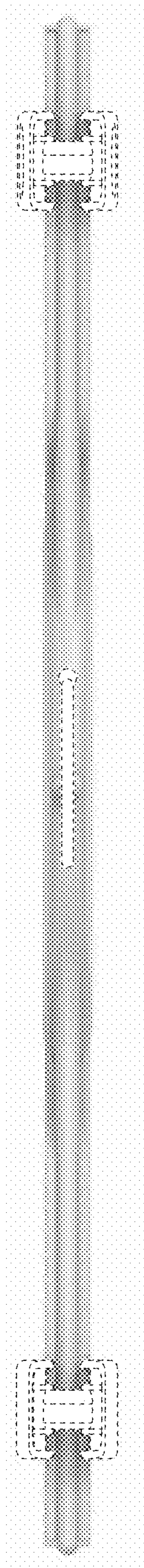

FIG. 6

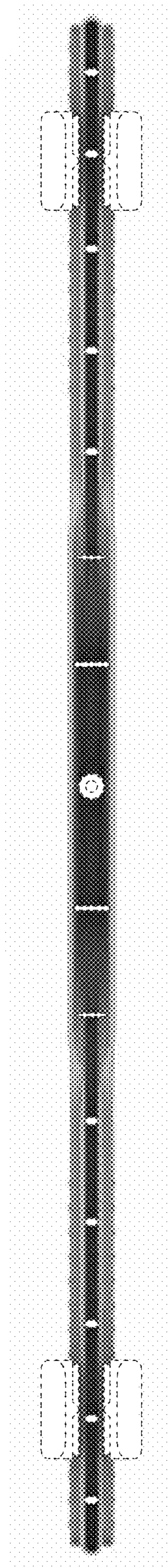

FIG. 7