



US00D918555S

(12) **United States Design Patent** (10) **Patent No.:** **US D918,555 S**  
**Sassi** (45) **Date of Patent:** **\*\* May 11, 2021**

(54) **SOLE FOR FOOTWEAR**  
(71) Applicant: **Valentino S.p.A.**, Milan (IT)  
(72) Inventor: **Stefano Sassi**, Milan (IT)  
(73) Assignee: **VALENTINO S.p.A.**, Milan (IT)  
(\*\*) Term: **15 Years**

D487,331 S \* 3/2004 Rogers ..... D2/951  
D490,596 S \* 6/2004 Belley ..... D2/956  
D499,536 S \* 12/2004 Castleberry ..... D2/947  
D500,401 S \* 1/2005 Matis ..... D2/953  
D518,280 S \* 4/2006 Matis ..... D2/951  
D550,436 S \* 9/2007 Matis ..... D2/953  
D551,834 S \* 10/2007 Favreau ..... D2/953  
D552,335 S \* 10/2007 Matis ..... D2/953

(Continued)

(21) Appl. No.: **29/700,937**  
(22) Filed: **Aug. 7, 2019**  
(30) **Foreign Application Priority Data**

May 10, 2019 (EM) ..... 006438289

(51) **LOC (13) Cl.** ..... **02-04**  
(52) **U.S. Cl.**  
USPC ..... **D2/957; D2/947; D2/951; D2/953;**  
**D2/960**

(58) **Field of Classification Search**  
USPC ..... D2/902, 906, 908, 916, 918, 925,  
D2/946-962, 977; 36/1, 1.5, 3 B, 22 R,  
36/24.5, 25 R, 28, 32 R, 34 R, 59 C,  
36/67 A, 101-107, 114-116, 117.3, 117.4,  
36/124-136  
CPC ..... A43B 13/00; A43B 13/02; A43B 13/023;  
A43B 13/026; A43B 13/04; A43B 13/08;  
A43B 13/10; A43B 13/12; A43B 13/14;  
A43B 13/141; A43B 13/143; A43B  
13/16; A43B 13/18; A43B 13/181; A43B  
13/187; A43B 13/189; A43B 13/20; A43B  
13/22; A43B 13/223; A43B 13/24; A43B  
13/28; A43B 13/30; A43B 13/32; A43B  
13/34; A43B 13/36

See application file for complete search history.

(56) **References Cited**  
U.S. PATENT DOCUMENTS

D354,845 S \* 1/1995 Bramani ..... D2/957  
D460,608 S \* 7/2002 Laberge ..... D2/953

**OTHER PUBLICATIONS**

Climbers Sneaker in Fabric and Leather, Valentino.com, [online].  
[site visited Aug. 14, 2020]. <URL: [https://www.valentino.com/en-US/low-top-sneakers\\_cod31432202864679157.html#dept=US\\_Shoes\\_M](https://www.valentino.com/en-US/low-top-sneakers_cod31432202864679157.html#dept=US_Shoes_M)> (Year: 2020).\*

(Continued)

*Primary Examiner* — T Chase Nelson  
*Assistant Examiner* — Jonathan J. Han  
(74) *Attorney, Agent, or Firm* — Thomas I Horstemeyer,  
LLP

(57) **CLAIM**

The ornamental design for a sole for footwear, as shown and described.

**DESCRIPTION**

FIG. 1 is a perspective view of a sole for footwear, showing my new design;  
FIG. 2 is a front view thereof;  
FIG. 3 is a rear view thereof;  
FIG. 4 is a side view thereof;  
FIG. 5 is a side view thereof, from a side opposite that of FIG. 4;  
FIG. 6 is a top view thereof; and,  
FIG. 7 is a bottom view thereof.  
The broken lines shown in the drawings of the sole for footwear are for the purpose of illustrating portions that form no part of the claimed design.

**1 Claim, 7 Drawing Sheets**

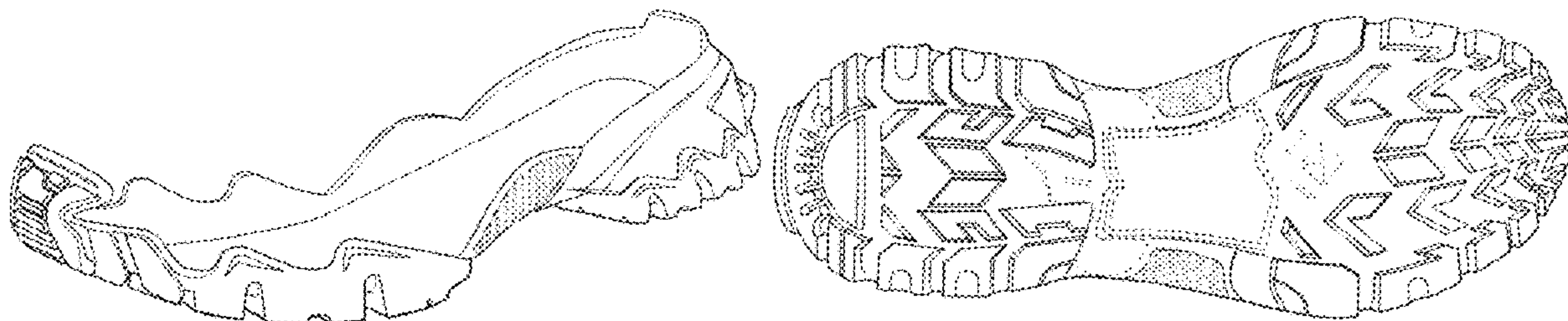

(56)

**References Cited**

U.S. PATENT DOCUMENTS

D552,337 S \* 10/2007 Parekh ..... D2/953  
 D564,740 S \* 3/2008 Matis ..... D2/956  
 D586,993 S \* 2/2009 Banik ..... D2/951  
 D591,946 S \* 5/2009 St-Louis ..... D2/951  
 D592,848 S \* 5/2009 Morgan ..... D2/951  
 D608,537 S \* 1/2010 Anderson ..... D2/960  
 D612,136 S \* 3/2010 Hubner ..... D2/954  
 D635,753 S \* 4/2011 Ng ..... D2/951  
 D635,754 S \* 4/2011 Mariman ..... D2/959  
 D646,471 S \* 10/2011 Mahoney ..... D2/907  
 D662,695 S \* 7/2012 McVicker ..... D2/902  
 D702,032 S \* 4/2014 Nakano ..... D2/959  
 D712,128 S \* 9/2014 Zaedow ..... D2/960  
 D717,033 S \* 11/2014 Law ..... D2/957  
 D717,034 S \* 11/2014 Bramani ..... D2/959  
 D724,296 S \* 3/2015 Law ..... D2/957  
 D811,705 S \* 3/2018 Hughes ..... D2/957

D822,968 S \* 7/2018 Moranges ..... D2/957  
 D836,892 S \* 1/2019 Jenkins ..... D2/947  
 D853,097 S \* 7/2019 Cass ..... D2/957  
 D866,146 S \* 11/2019 Cass ..... D2/957  
 D883,630 S \* 5/2020 Cass ..... D2/957  
 D885,734 S \* 6/2020 Cass ..... D2/957  
 D891,061 S \* 7/2020 Nelson ..... D2/957  
 D891,064 S \* 7/2020 Dean ..... D2/958

OTHER PUBLICATIONS

Valentino Garavani I #Climbers sneakers, YouTube.com, Valentino, Jun. 13, 2019, [online], [site visited Aug. 14, 2020]. <URL: <https://www.youtube.com/watch?v=dtN4BKdrh0M>> (Year: 2019).\*

Valentino Goes Gargantuan with New Garavani Climbers Sneaker, HypeBeast.com, Jun. 13, 2019 By Jake Silbert, [online], [site visited Aug. 14, 2020]. <URL: <https://hypebeast.com/2019/6/valentino-garavani-climbers-sneaker-launch-release-campaign>> (Year: 2019).\*

\* cited by examiner

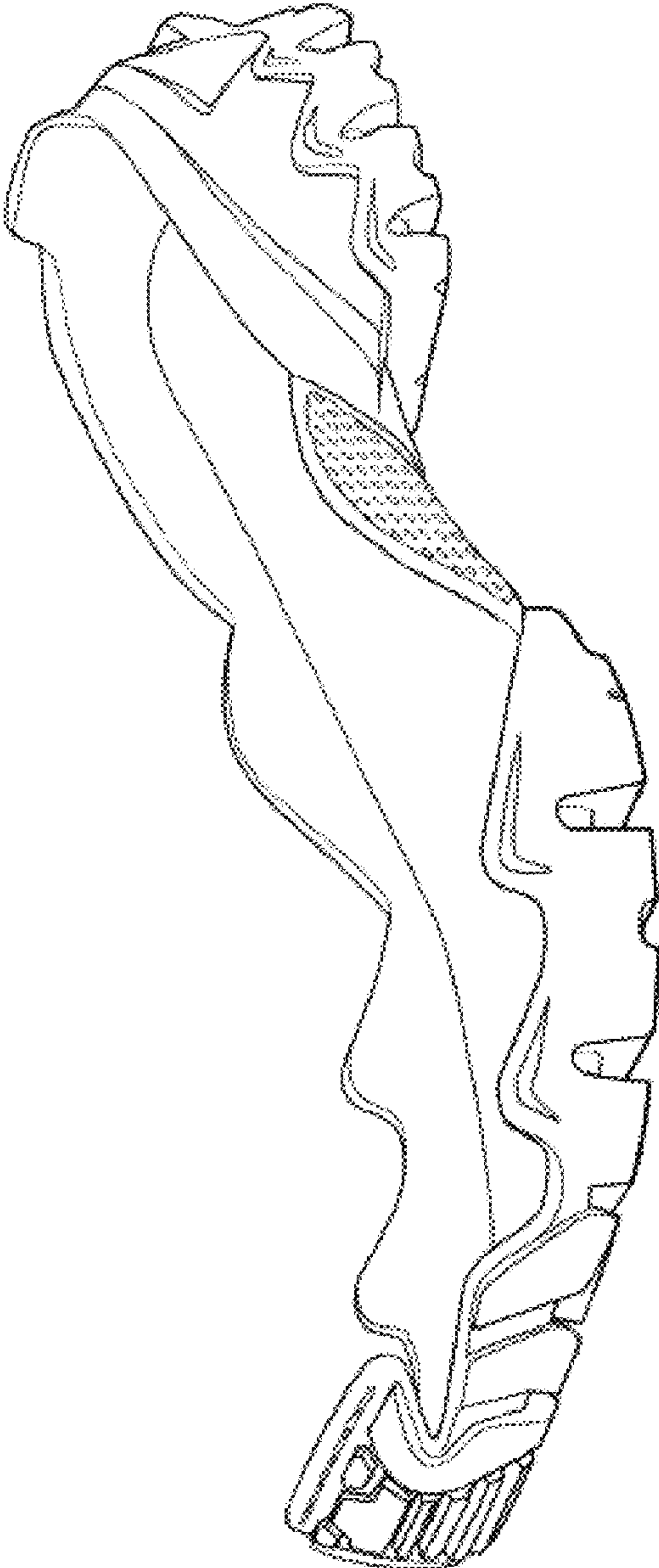

FIG. 1

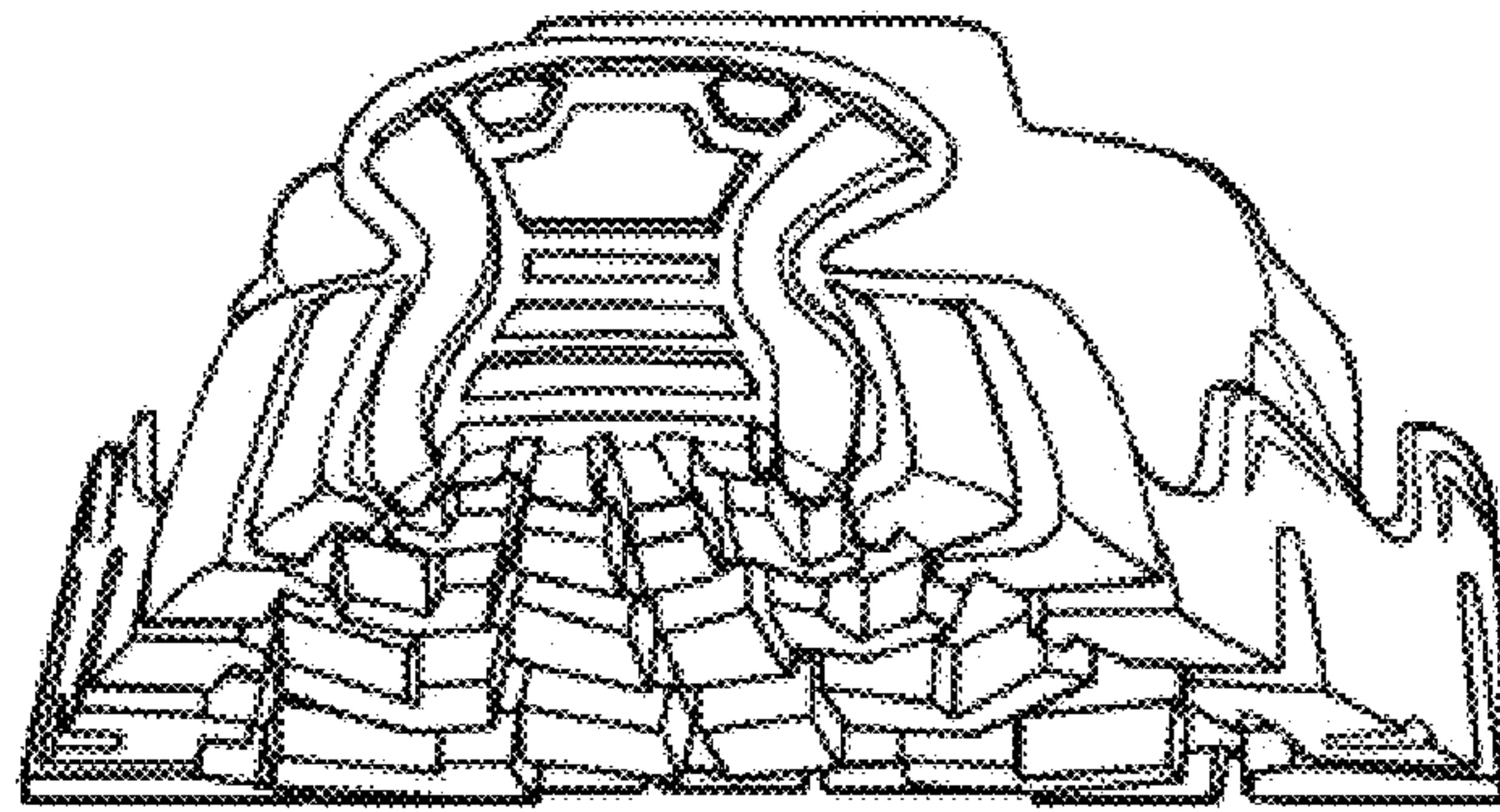

FIG. 2



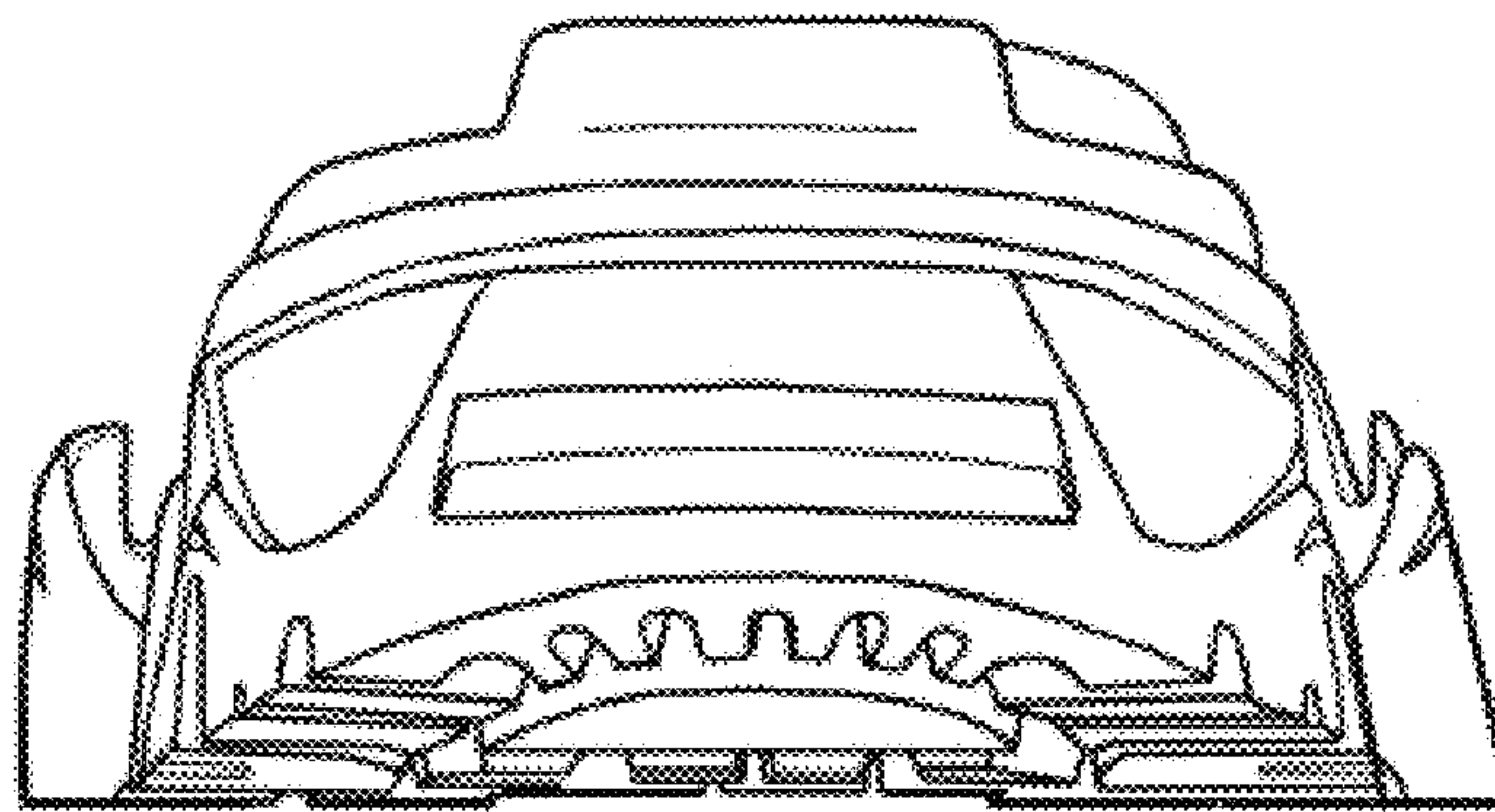

FIG. 3

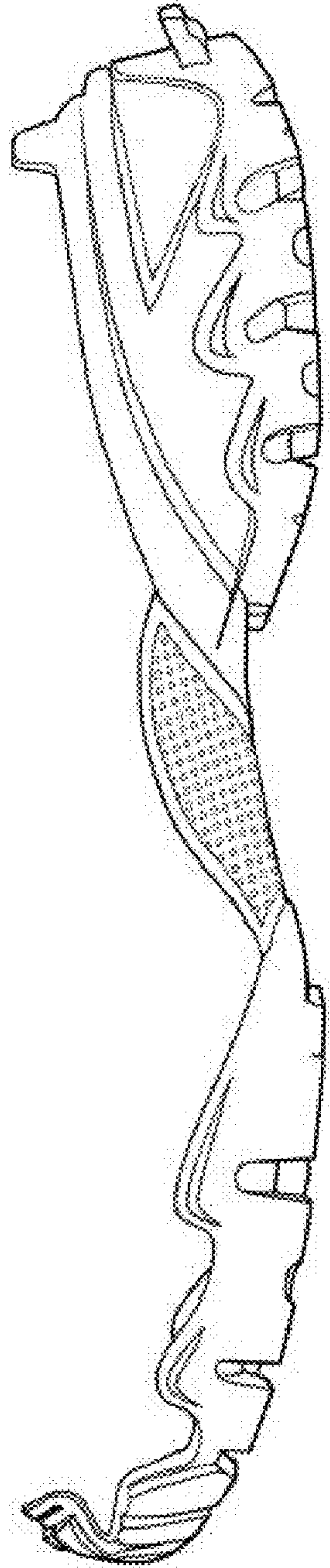

FIG. 4

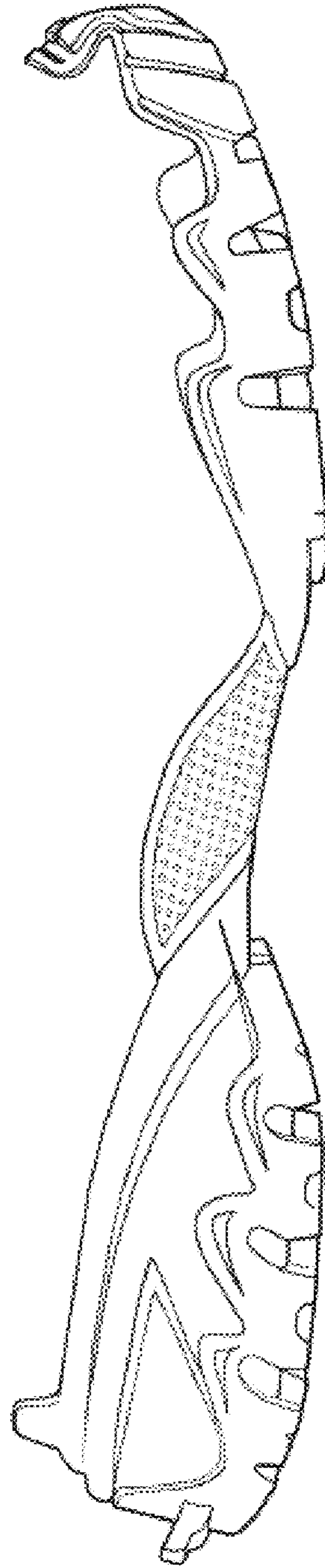

FIG. 5

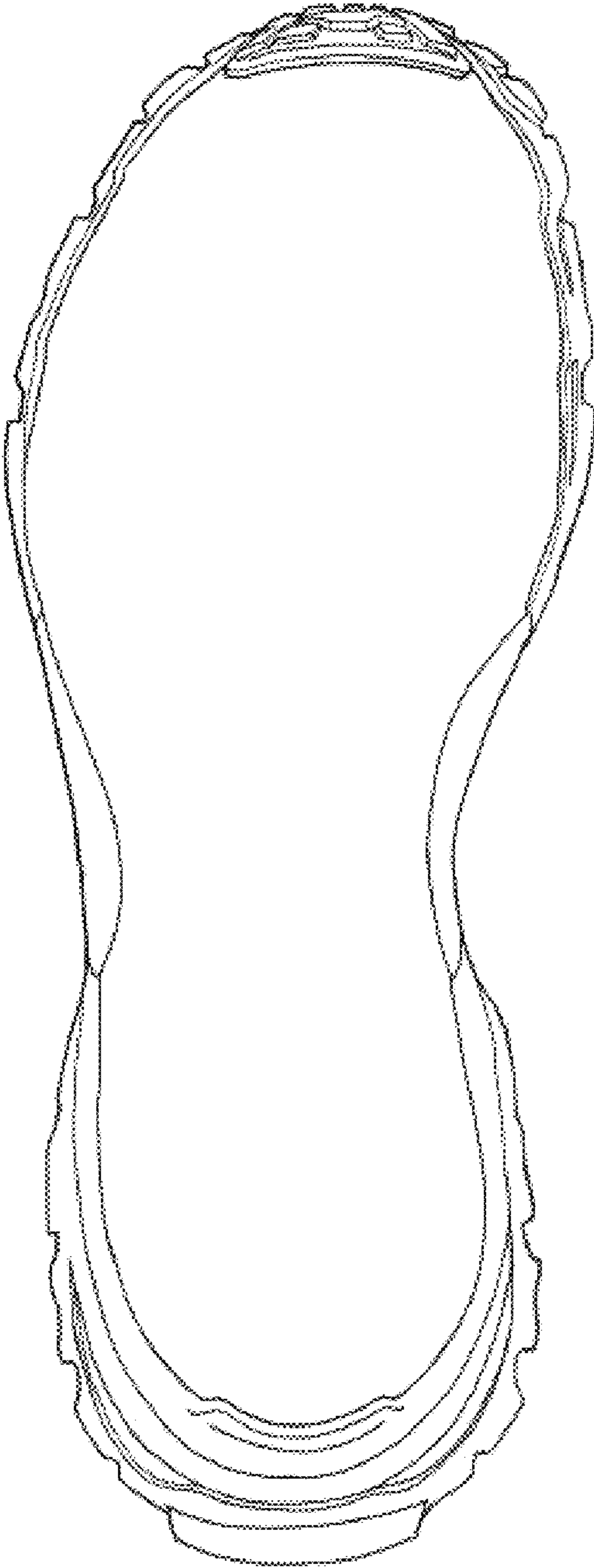

FIG. 6



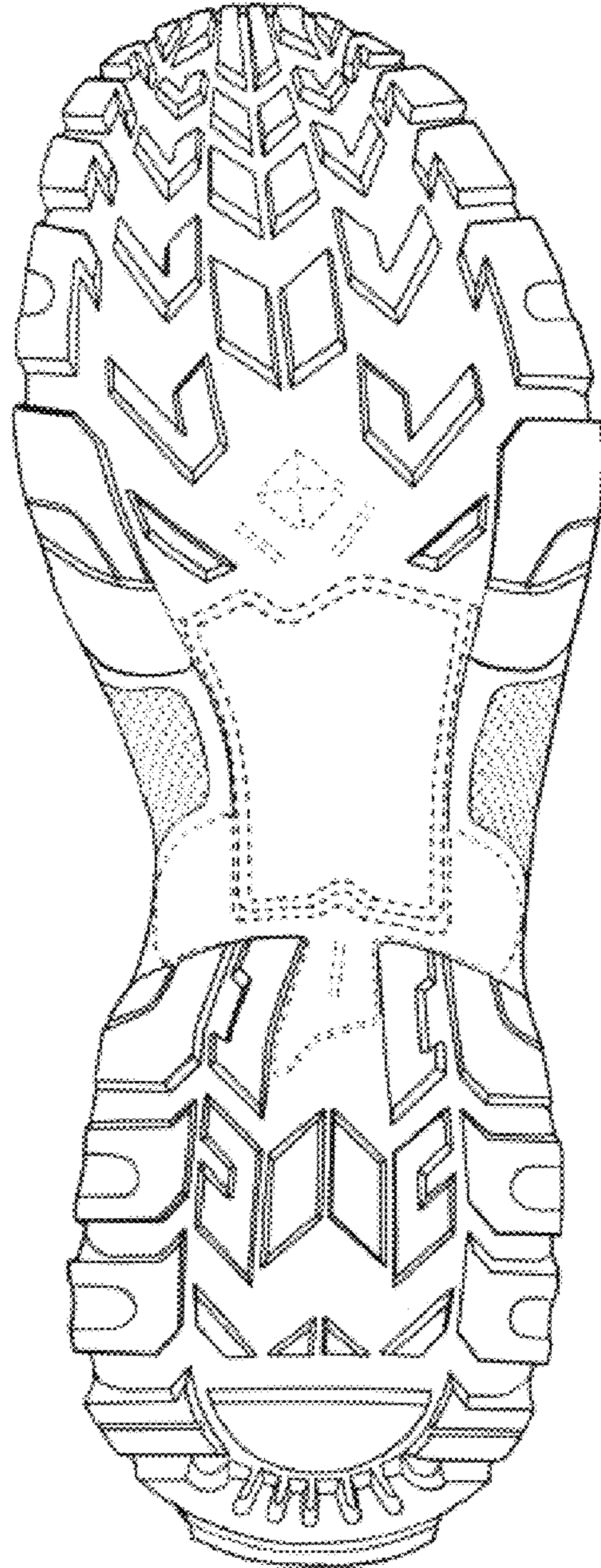

FIG. 7