



US00D918530S

(12) **United States Design Patent** (10) **Patent No.:** **US D918,530 S**
Zimmer (45) **Date of Patent:** **** May 11, 2021**

(54) **CONCEALABLE BELT WITH POUCHES**

(71) Applicant: **Trent Zimmer**, Houma, LA (US)

(72) Inventor: **Trent Zimmer**, Houma, LA (US)

(**) Term: **15 Years**

(21) Appl. No.: **29/707,612**

(22) Filed: **Sep. 30, 2019**

(51) **LOC (13) Cl.** **02-07**

(52) **U.S. Cl.**
USPC **D2/627**

(58) **Field of Classification Search**
USPC D2/624-629, 631, 635-640, 720, 815,
D2/838, 859, 894; D3/221, 222, 224,
(Continued)

(56) **References Cited**

U.S. PATENT DOCUMENTS

2,449,425 A * 9/1948 Stieger A41F 11/16
2/314
D259,151 S * 5/1981 Kishbaugh 224/662
(Continued)

Primary Examiner — Kevin K Rudzinski

Assistant Examiner — Clare Ann Gannon

(74) *Attorney, Agent, or Firm* — F. Wayne Thompson, Jr.;
Asgard Patent Services, LLC

(57) **CLAIM**

The ornamental design for a concealable belt with pouches,
as shown and described.

DESCRIPTION

FIG. 1 is a front, top, right side isometric view of a first
embodiment of a concealable belt with pouches;
FIG. 2 is a rear, bottom, left side isometric view of the
concealable belt with pouches shown in FIG. 1;

FIG. 3 is a front view of the concealable belt with pouches
shown in FIG. 1;

FIG. 4 is a right side view of the concealable belt with
pouches shown in FIG. 1;

FIG. 5 is a rear view of the concealable belt with pouches
shown in FIG. 1;

FIG. 6 is a left side view of the concealable belt with
pouches shown in FIG. 1;

FIG. 7 is a top view of the concealable belt with pouches
shown in FIG. 1;

FIG. 8 is a bottom view of the concealable belt with pouches
shown in FIG. 1;

FIG. 9 is a front, top, right side isometric view of the
concealable belt with pouches shown in FIG. 1, as if worn;

FIG. 10 is a front, top, right side isometric view of a second
embodiment of a concealable belt with pouches;

FIG. 11 is a rear, bottom, left side isometric view of the
concealable belt with pouches shown in FIG. 10;

FIG. 12 is a front view of the concealable belt with pouches
shown in FIG. 10;

FIG. 13 is a right side view of the concealable belt with
pouches shown in FIG. 10;

FIG. 14 is a rear view of the concealable belt with pouches
shown in FIG. 10;

FIG. 15 is a left side view of the concealable belt with
pouches shown in FIG. 10;

FIG. 16 is a top view of the concealable belt with pouches
shown in FIG. 10;

FIG. 17 is a bottom view of the concealable belt with
pouches shown in FIG. 10; and,

FIG. 18 is a front, top, right side isometric view of the
concealable belt with pouches shown in FIG. 10, as if worn.

The hatching appearing on the pouches of the concealable
belt with pouches indicates fabric.

The thicker broken lines depict stitching on the article that
forms no part of the claimed design.

The straps represented as broken lines depict environment
that forms no part of the claimed design.

The triangular cutouts represented as broken lines in FIGS.
10-12, 14 and 18 depict portions of the article that form no
part of the claimed design.

1 Claim, 10 Drawing Sheets

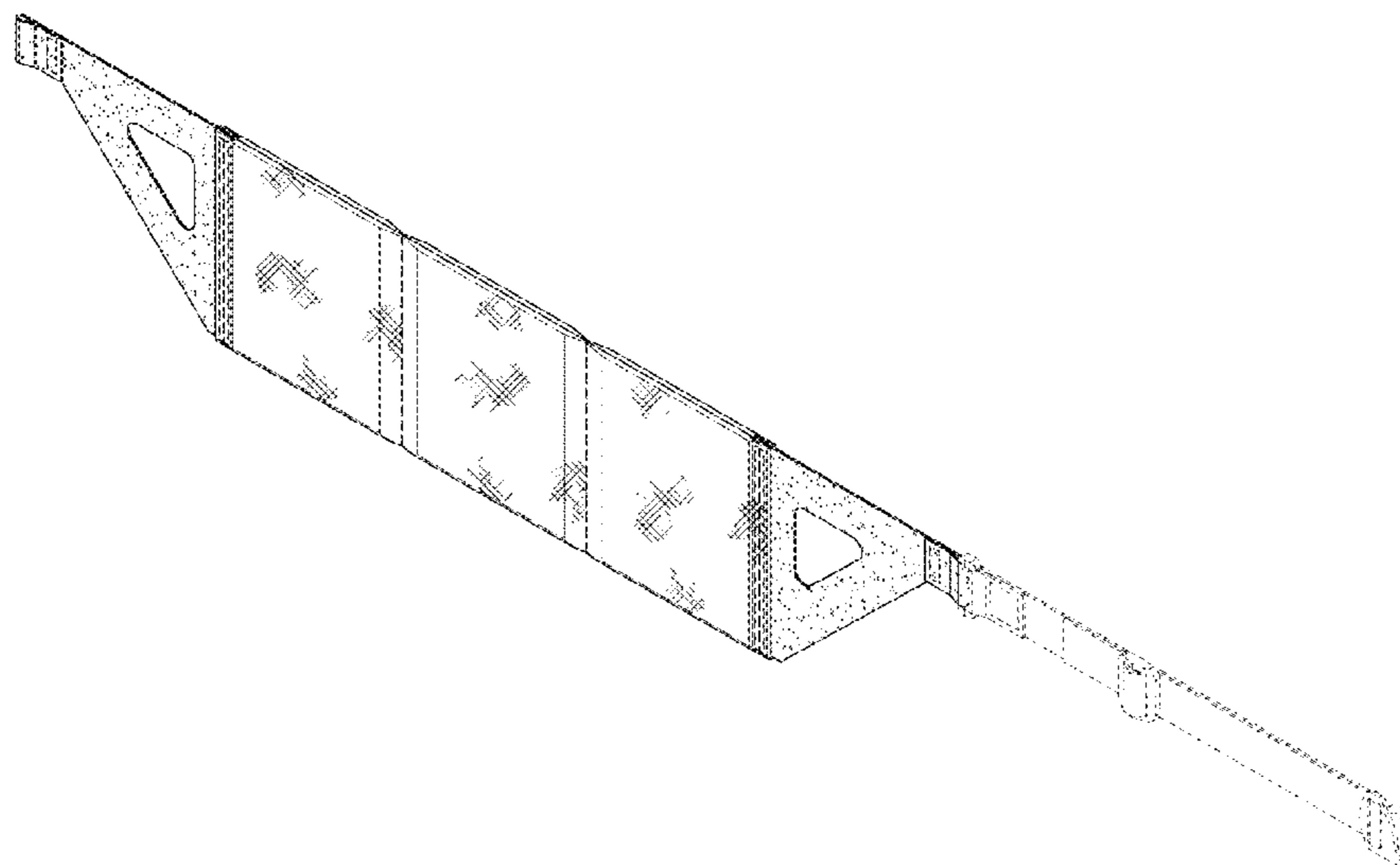

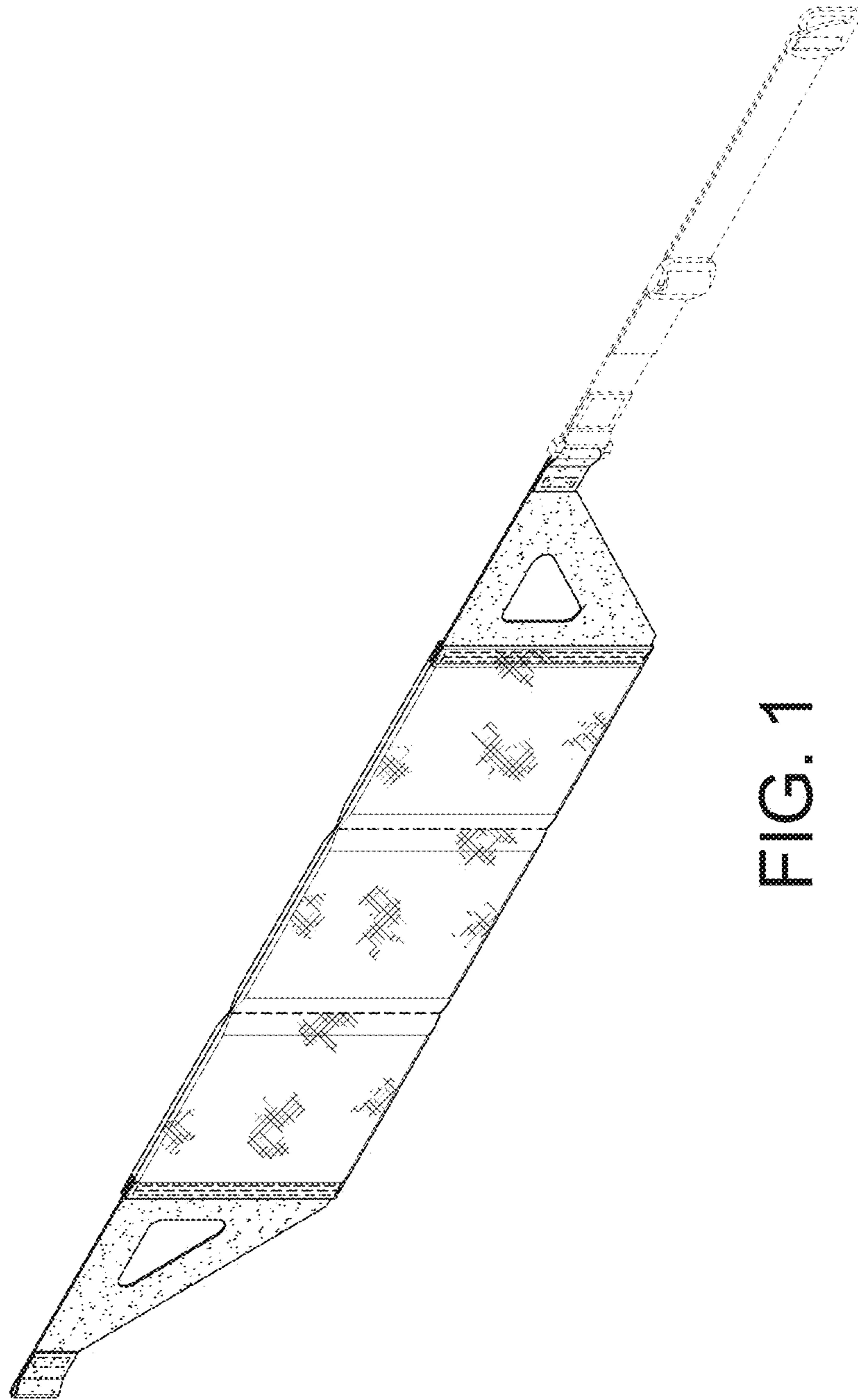

FIG. 1

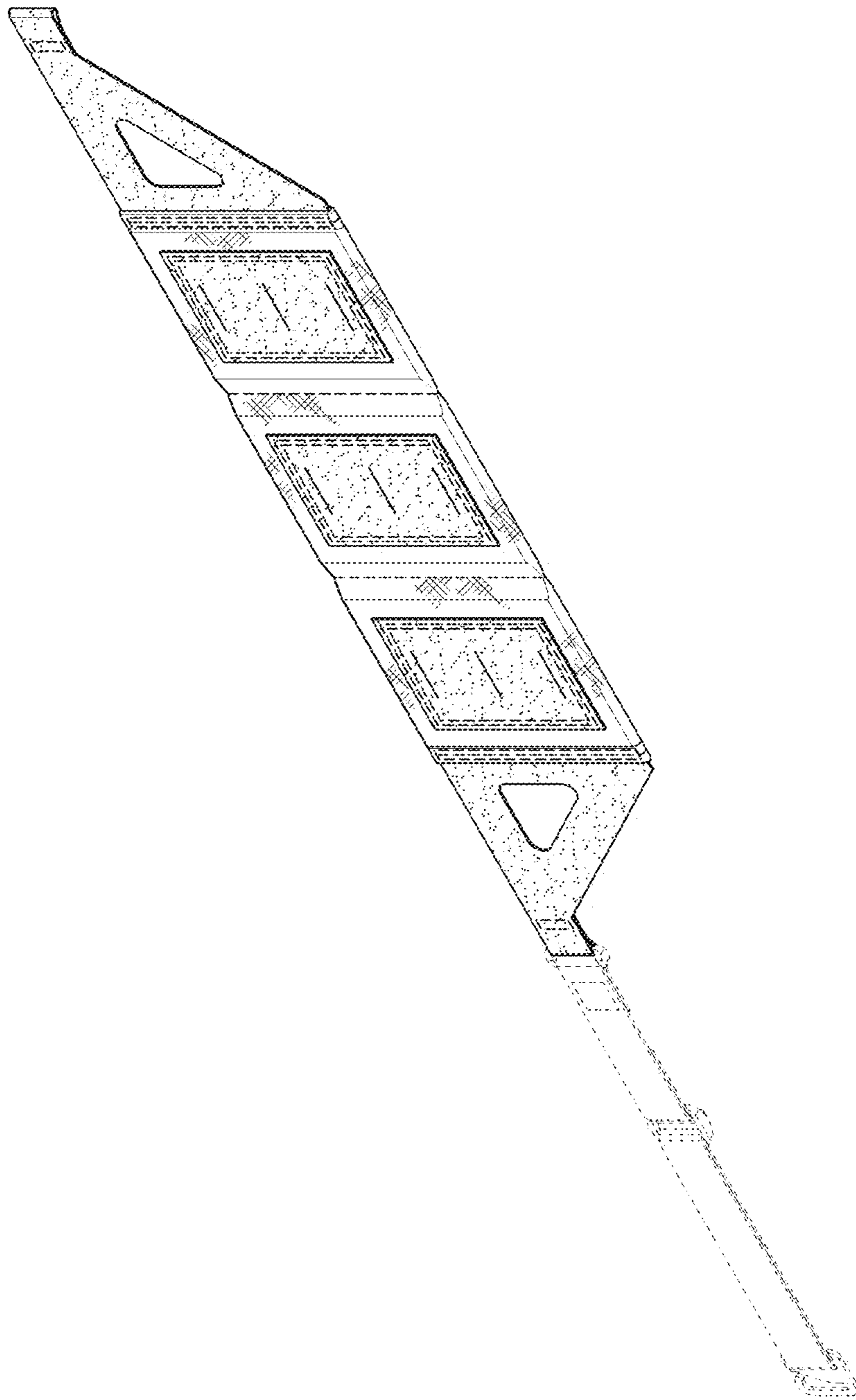

FIG. 2



FIG. 7

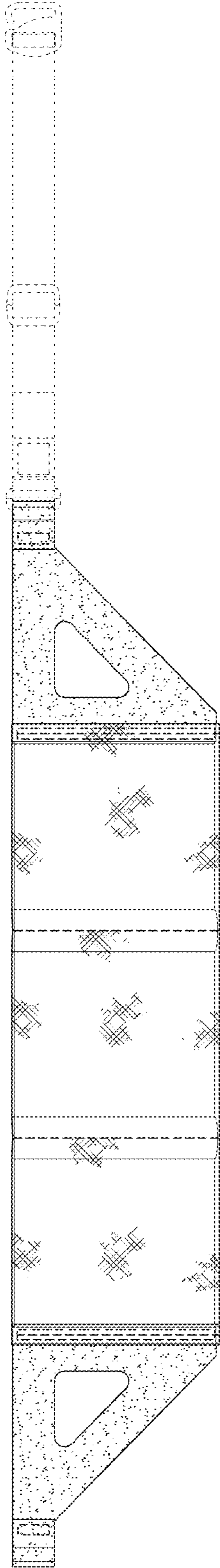

FIG. 3



FIG. 8

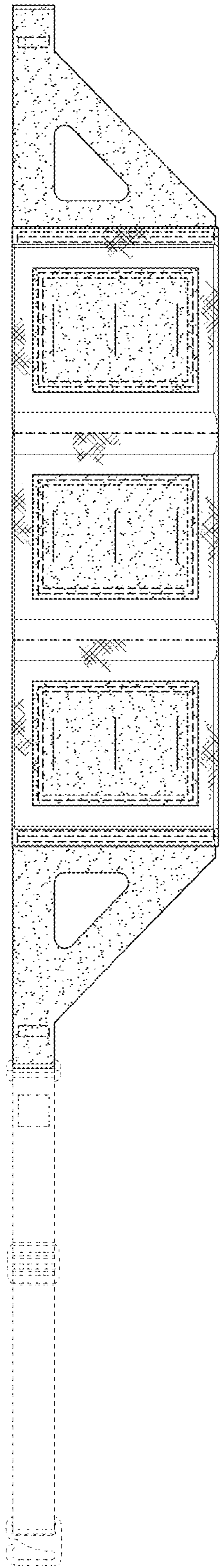

FIG. 5

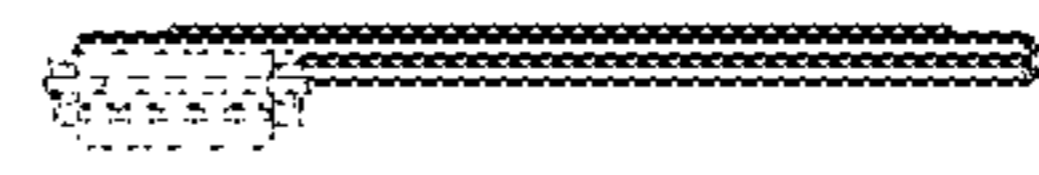

FIG. 4

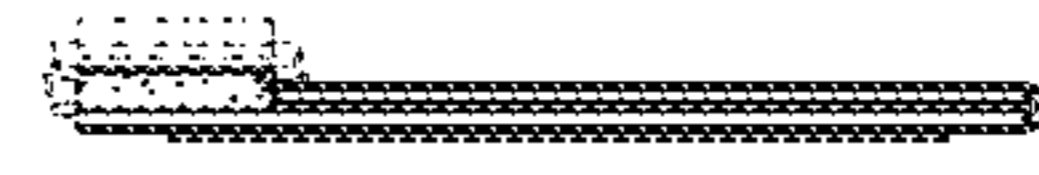

FIG. 6

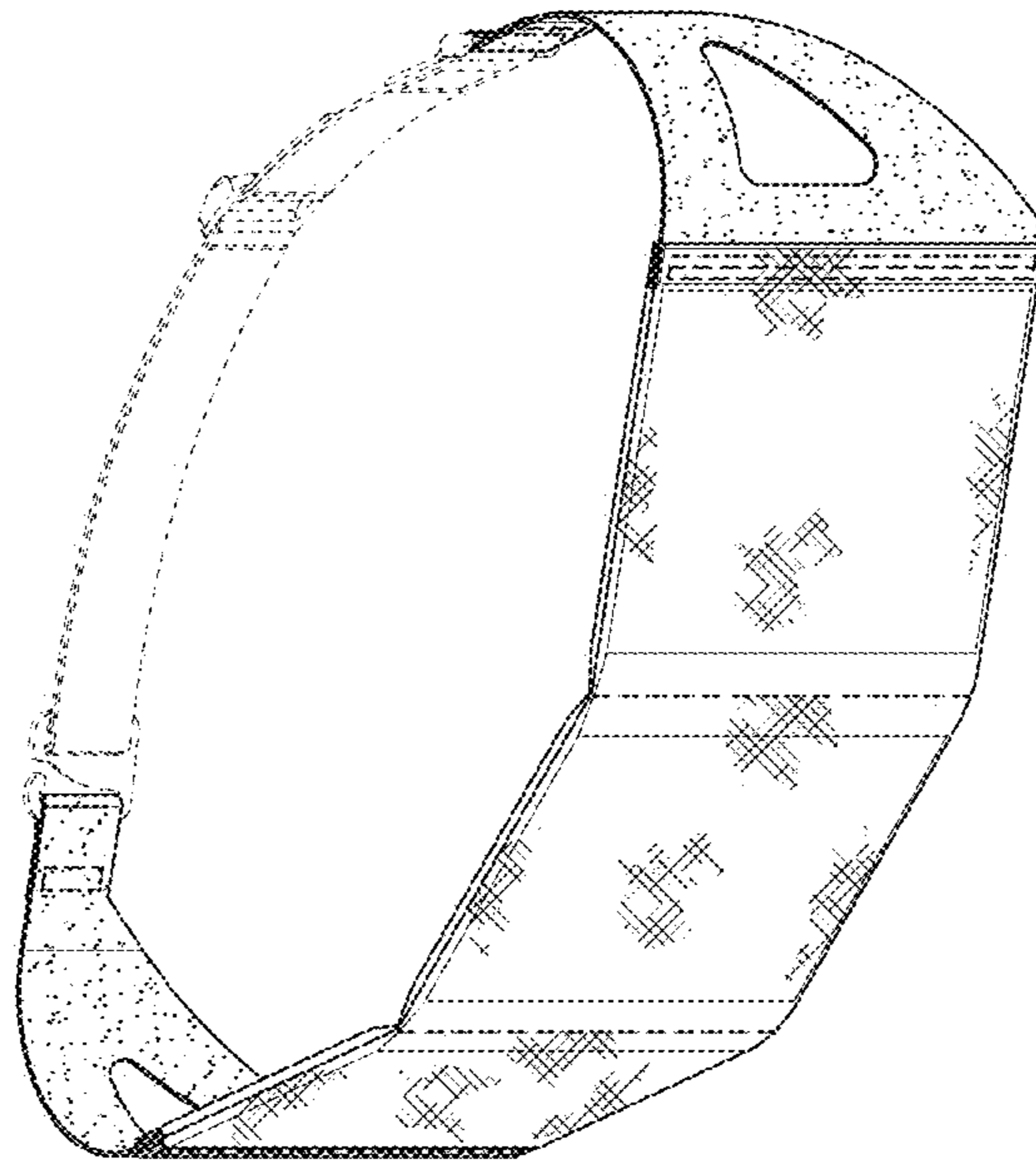

FIG. 9

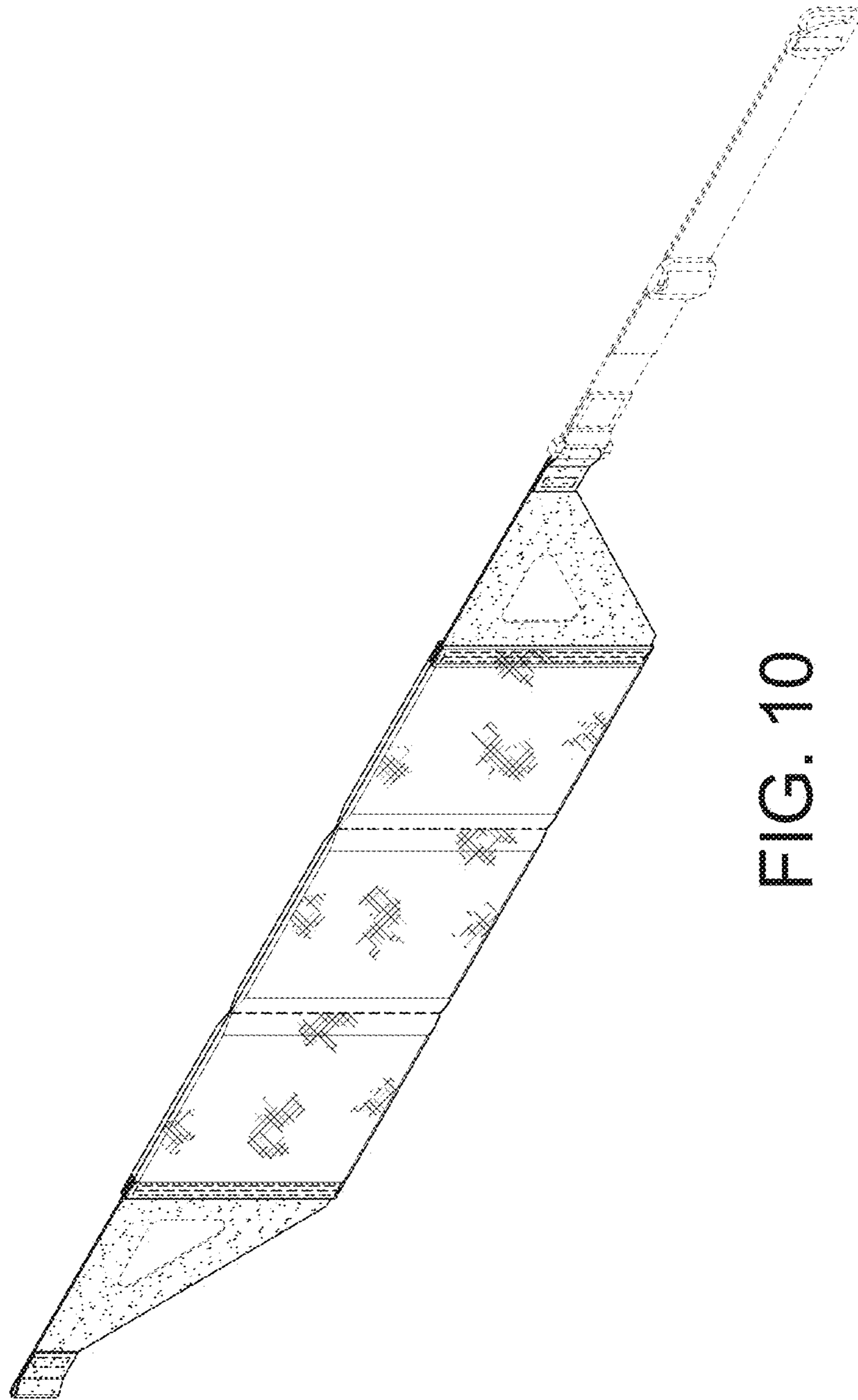

FIG. 10

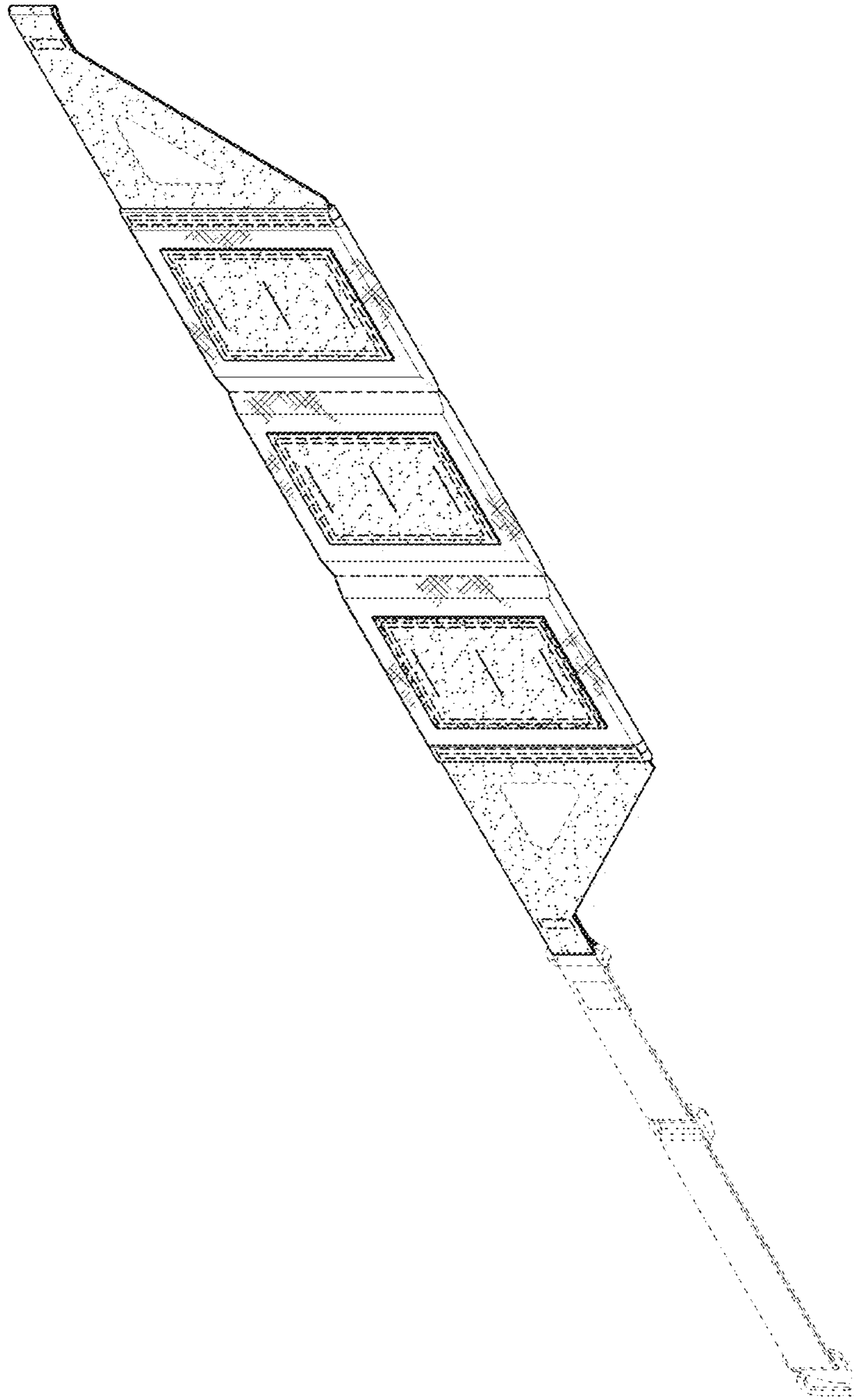

FIG. 11

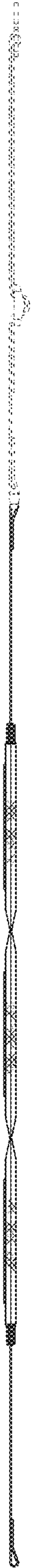

FIG. 16

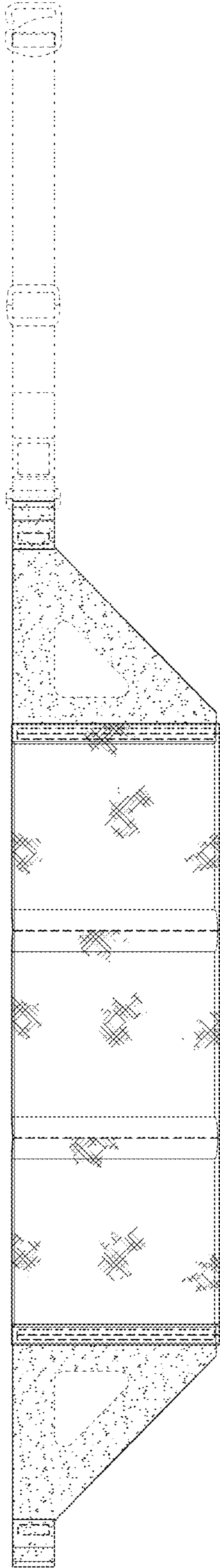

FIG. 12



FIG. 17

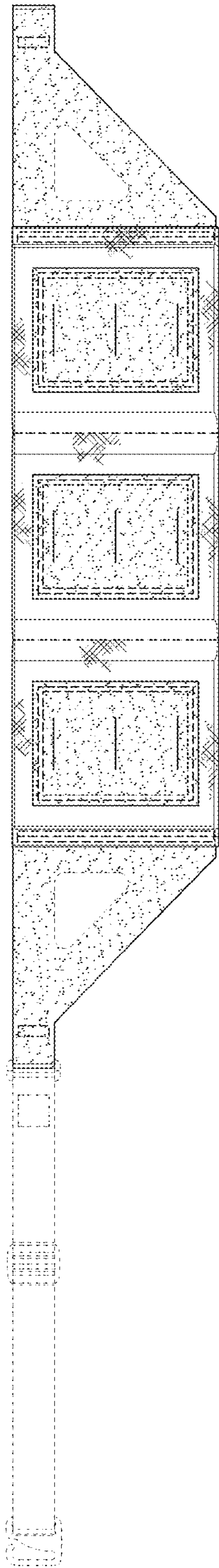

FIG. 14

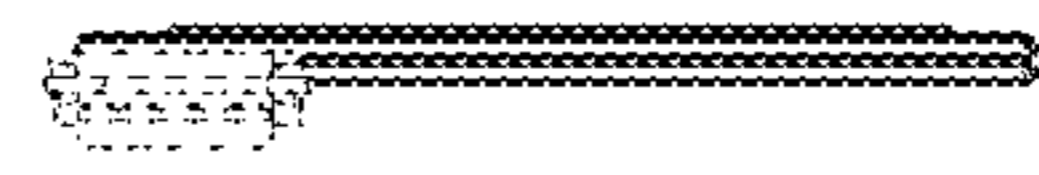

FIG. 13

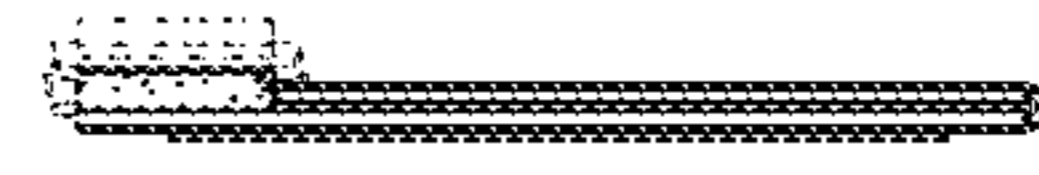

FIG. 15

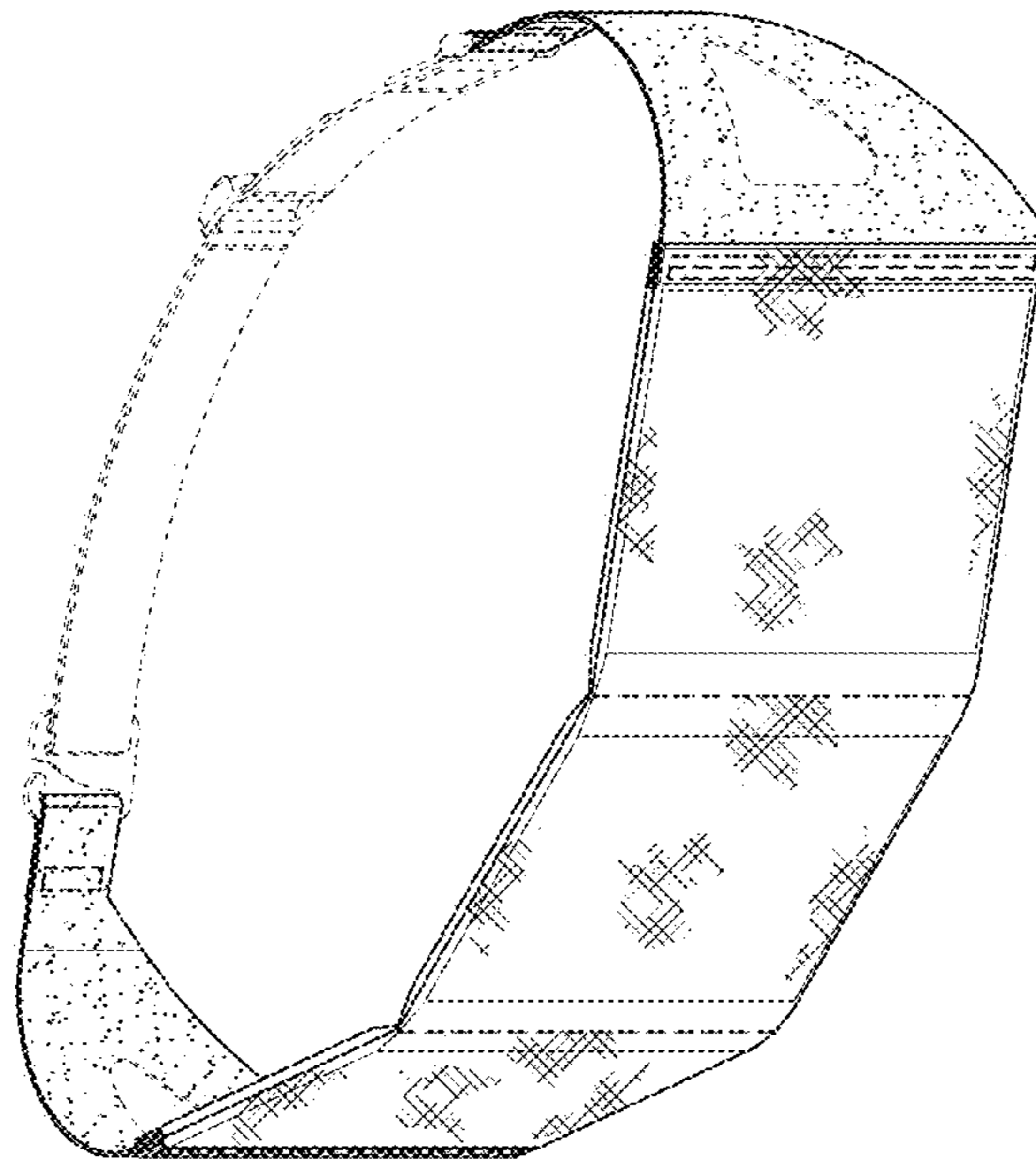

FIG. 18