



US00D918498S

(12) **United States Design Patent**  
**Park et al.**

(10) **Patent No.:** **US D918,498 S**  
(45) **Date of Patent:** **\*\* May 4, 2021**

- (54) **CLOTHING CARE MACHINE**
- (71) Applicant: **Samsung Electronics Co., Ltd.**,  
Suwon-si (KR)
- (72) Inventors: **Minji Park**, Bucheon-si (KR);  
**Hyeokjin Choi**, Seoul (KR); **Haeyoon Park**,  
Seoul (KR); **Joonho Lee**, Seoul (KR); **Kyoung-Ae Lim**,  
Seongnam-si (KR)
- (73) Assignee: **Samsung Electronics Co., Ltd.**,  
Suwon-si (KR)
- (\*\*) Term: **15 Years**
- (21) Appl. No.: **29/680,421**
- (22) Filed: **Feb. 15, 2019**
- (30) **Foreign Application Priority Data**  
Aug. 16, 2018 (KR) ..... 30-2018-0038079
- (51) **LOC (13) Cl.** ..... **15-05**
- (52) **U.S. Cl.**  
USPC ..... **D32/6**
- (58) **Field of Classification Search**  
USPC ..... D32/1-3, 5-6, 10, 25  
CPC ..... D06F 58/20; D06F 73/02; D06F 58/10;  
D06F 58/12; D06F 58/203  
See application file for complete search history.

- (56) **References Cited**  
**U.S. PATENT DOCUMENTS**  
D197,085 S \* 12/1963 Bequette ..... D32/8  
D532,563 S \* 11/2006 Kim ..... D32/6  
D640,430 S \* 6/2011 Jee ..... D32/6  
D643,165 S \* 8/2011 Song ..... D32/8  
8,037,626 B2 \* 10/2011 Moon ..... D06F 58/10  
38/14  
D663,495 S \* 7/2012 Song ..... D32/8

- 8,215,133 B2 \* 7/2012 Kim ..... D06F 58/203  
68/5 C
- 8,424,141 B2 \* 4/2013 Yoo ..... D06F 58/203  
8/149.3
- 8,484,868 B2 \* 7/2013 Kim ..... D06F 58/12  
38/14
- 8,505,340 B2 \* 8/2013 Kim ..... D06F 58/10  
68/5 C
- D732,769 S \* 6/2015 Chung ..... D32/25
- D732,770 S \* 6/2015 Choi ..... D32/25

(Continued)

*Primary Examiner* — Michelle E. Wilson  
(74) *Attorney, Agent, or Firm* — NSIP Law

(57) **CLAIM**

We claim the ornamental design for a clothing care machine, as shown and described.

**DESCRIPTION**

FIG. 1 is a front perspective view of a clothing care machine showing our new design;  
 FIG. 2 is a front view thereof;  
 FIG. 3 is a rear view thereof;  
 FIG. 4 is a left-side view thereof;  
 FIG. 5 is a right-side view thereof;  
 FIG. 6 is a top view thereof;  
 FIG. 7 is a bottom view thereof;  
 FIG. 8 is an enlarged view of the claimed portion shown in FIG. 2; and,  
 FIG. 9 is another enlarged view of the claimed portion shown in FIG. 2, in which a graphical user interface in broken lines is provided to illustrate an environment.  
 The dash-dash broken lines in the figures depicting portions of the clothing care machine form no part of the claimed design.  
 The dash-dash broken lines showing the characters and the symbol in FIG. 9 illustrate environmental structure and form no part of the claimed design. The dot-dash broken lines in the figures represent a boundary line and form no part of the claimed design.

**1 Claim, 9 Drawing Sheets**

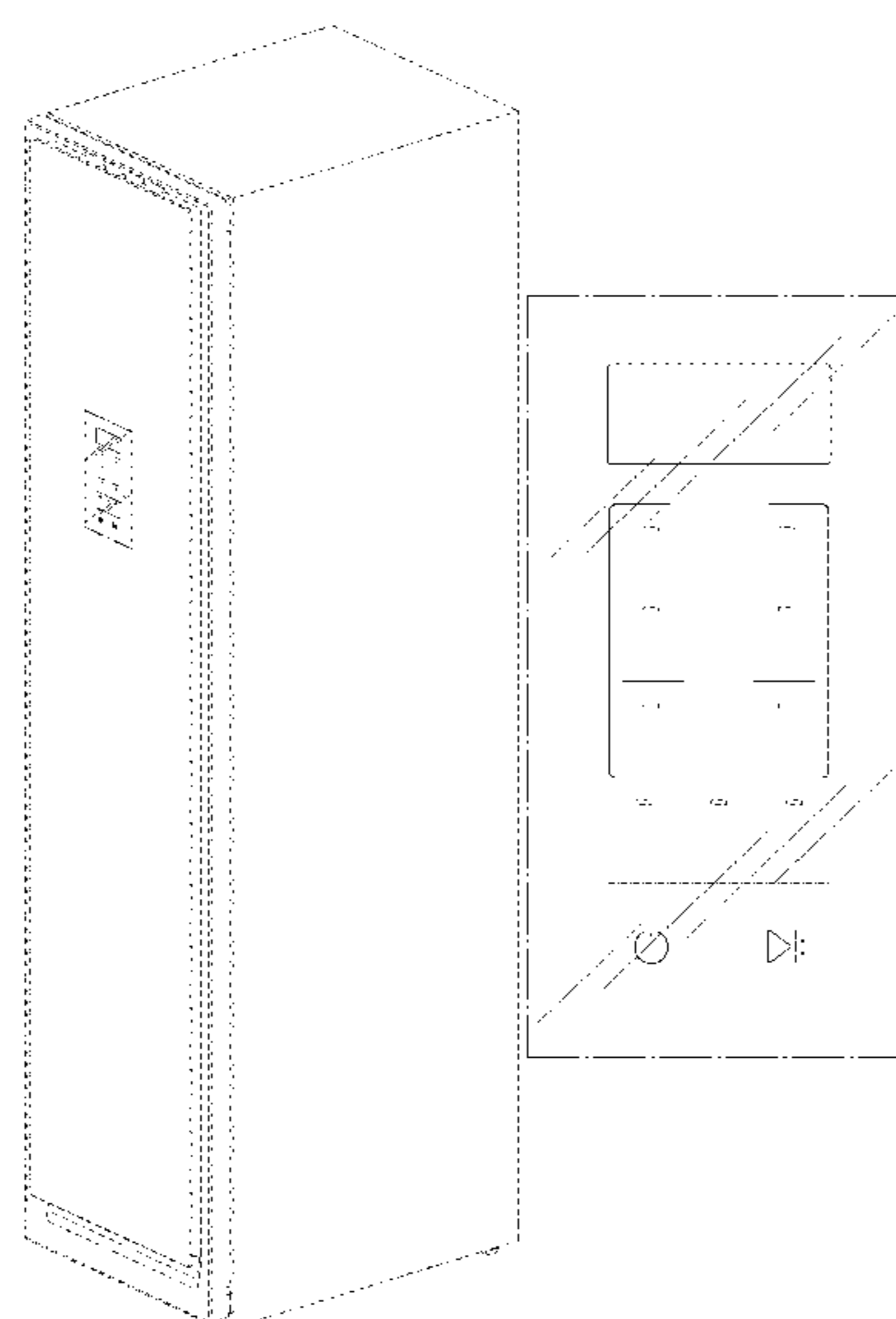

(56)

**References Cited**

U.S. PATENT DOCUMENTS

|              |    |   |         |               |       |                      |
|--------------|----|---|---------|---------------|-------|----------------------|
| D732,771     | S  | * | 6/2015  | Chung         | ..... | D32/25               |
| D732,772     | S  | * | 6/2015  | Chung         | ..... | D32/25               |
| D732,773     | S  | * | 6/2015  | Chung         | ..... | D32/25               |
| D732,774     | S  | * | 6/2015  | Chung         | ..... | D32/25               |
| D732,775     | S  | * | 6/2015  | Chung         | ..... | D32/25               |
| D743,127     | S  | * | 11/2015 | Chung         | ..... | D32/25               |
| D743,128     | S  | * | 11/2015 | Chung         | ..... | D32/25               |
| D743,129     | S  | * | 11/2015 | Chung         | ..... | D32/25               |
| D743,130     | S  | * | 11/2015 | Choi          | ..... | D32/25               |
| D743,652     | S  | * | 11/2015 | Chung         | ..... | D32/25               |
| D743,653     | S  | * | 11/2015 | Chung         | ..... | D32/25               |
| D743,654     | S  | * | 11/2015 | Chung         | ..... | D32/25               |
| D824,124     | S  | * | 7/2018  | Lee           | ..... | D32/6                |
| D827,236     | S  | * | 8/2018  | Chung         | ..... | D32/25               |
| D828,656     | S  | * | 9/2018  | Chung         | ..... | D32/6                |
| D836,271     | S  | * | 12/2018 | Chung         | ..... | D32/6                |
| D839,515     | S  | * | 1/2019  | Chung         | ..... | D32/25               |
| D897,058     | S  | * | 9/2020  | Kim           | ..... | D32/6                |
| 2001/0037590 | A1 | * | 11/2001 | MacGregor     | ..... | D06F 73/02<br>38/3   |
| 2008/0136295 | A1 | * | 6/2008  | Aizpuru Borda | ..... | D06F 58/10<br>312/31 |
| 2010/0058813 | A1 | * | 3/2010  | Moon          | ..... | D06F 73/02<br>68/6   |
| 2012/0240425 | A1 | * | 9/2012  | Park          | ..... | D06F 58/20<br>34/202 |

\* cited by examiner

FIG. 1

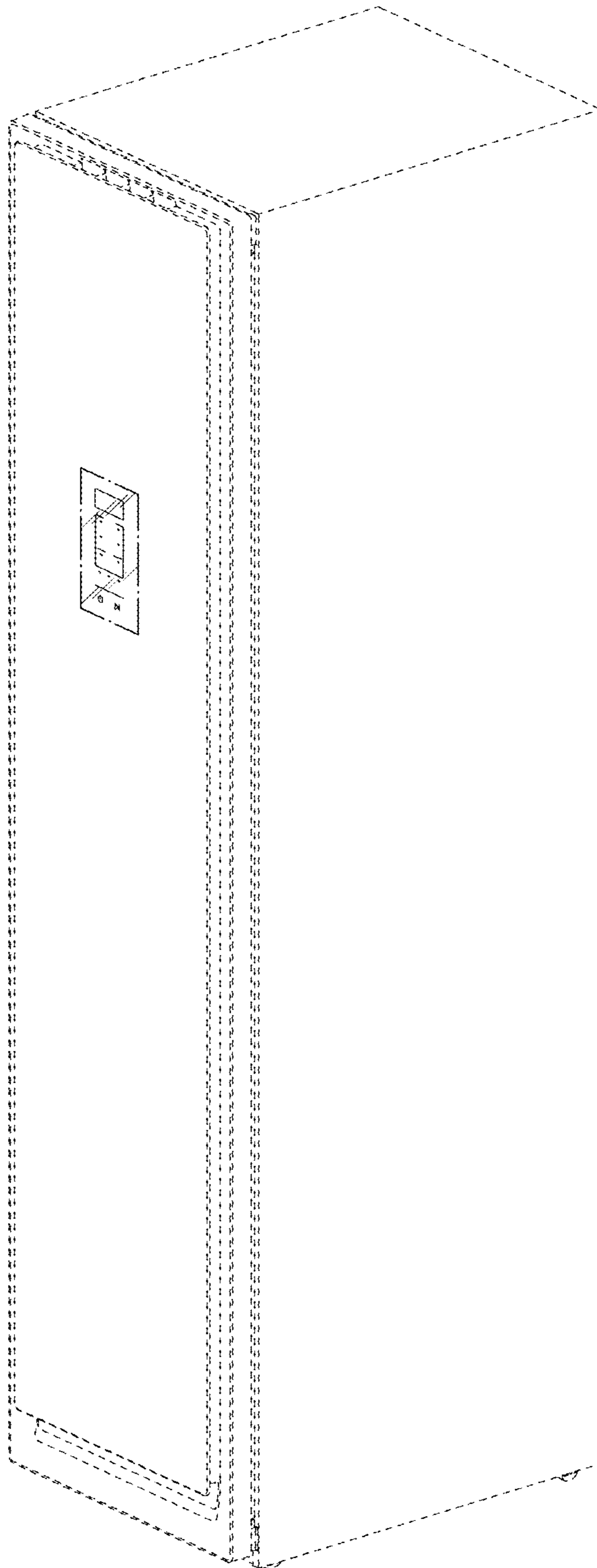

FIG. 2

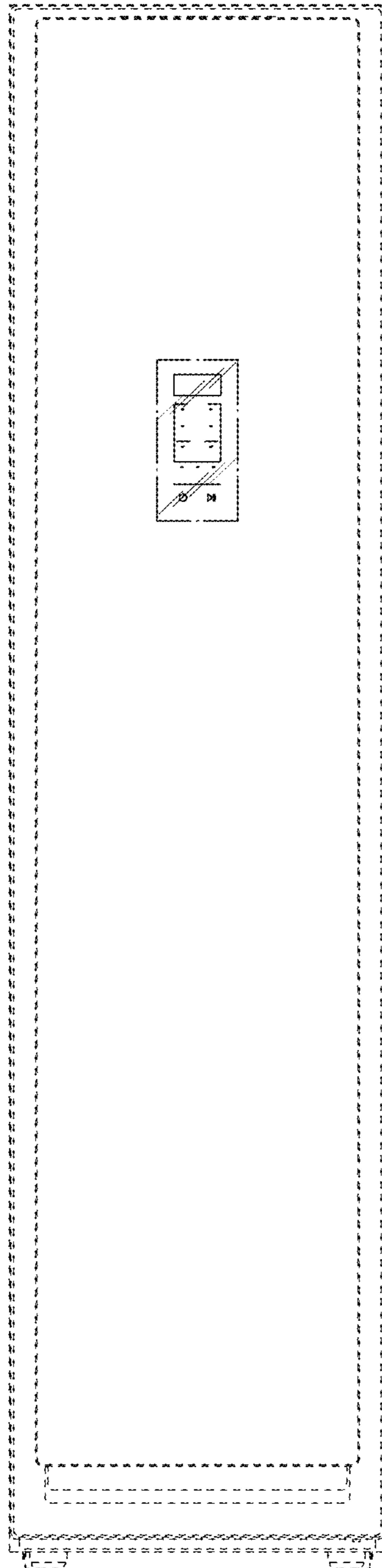

FIG. 3

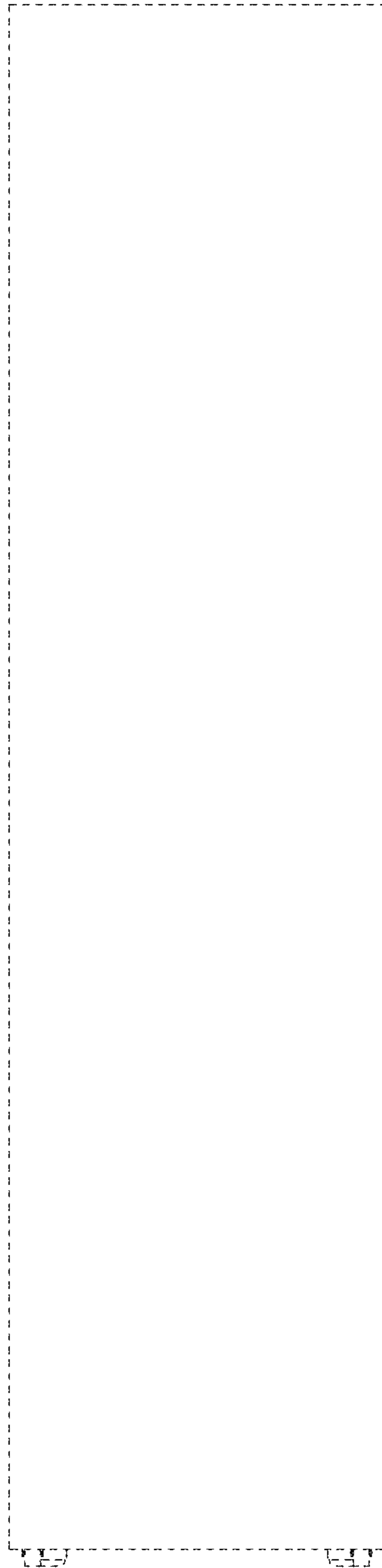

FIG. 4

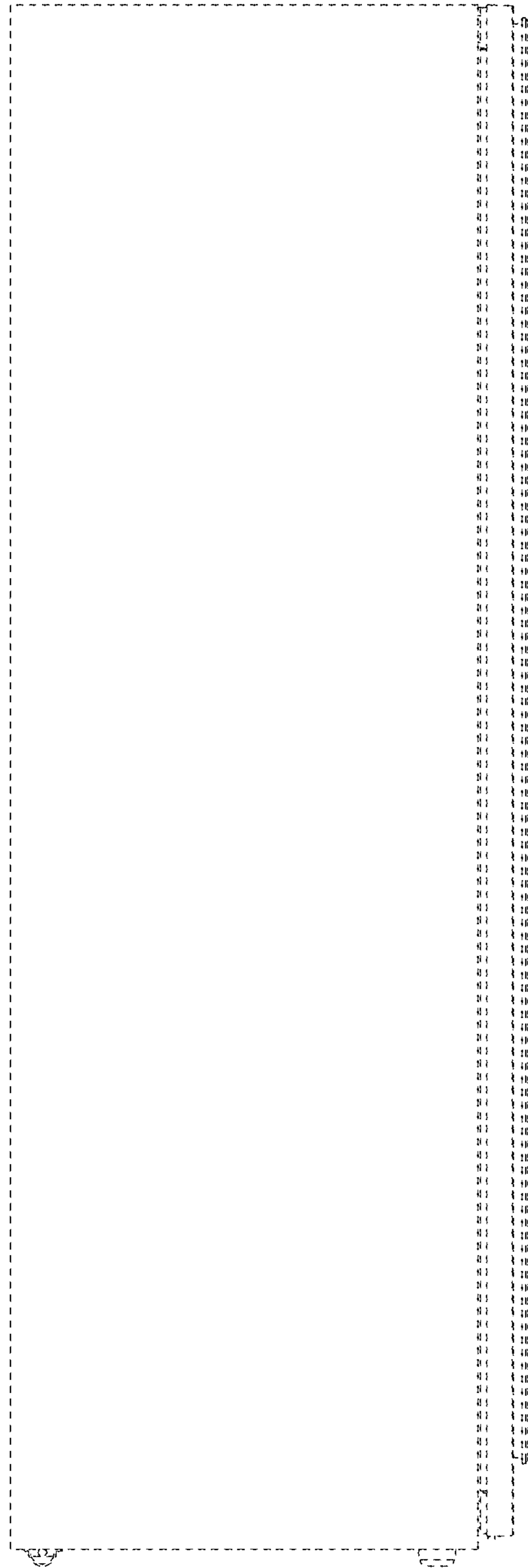

FIG. 5

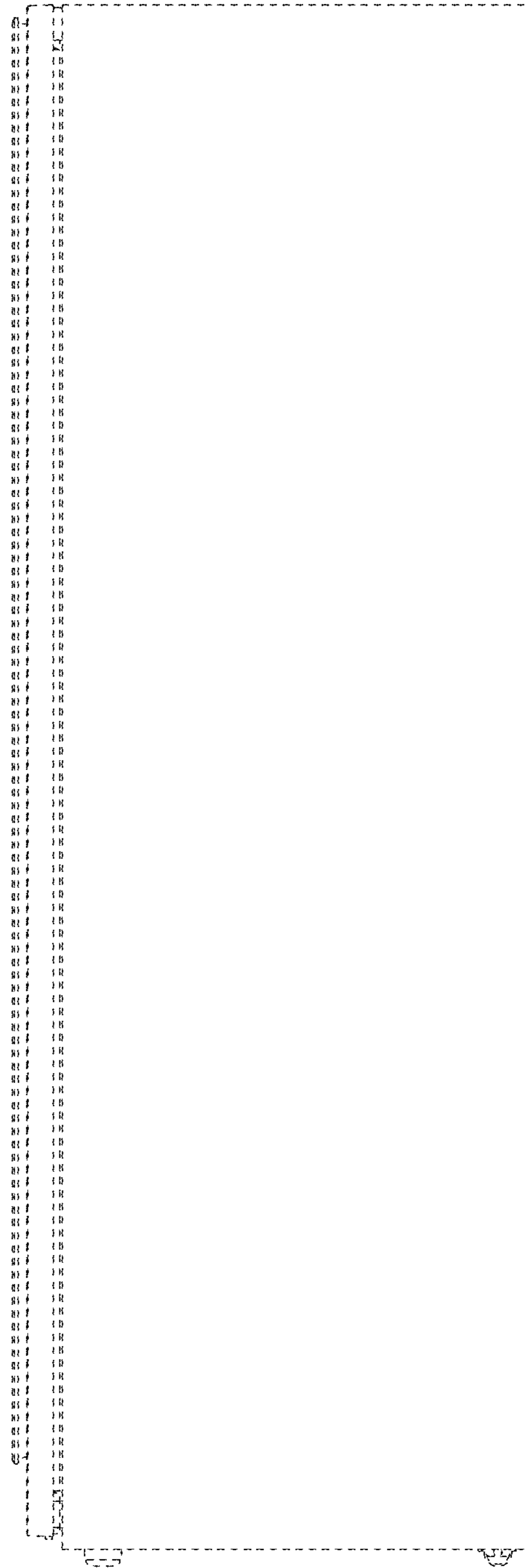

FIG. 6

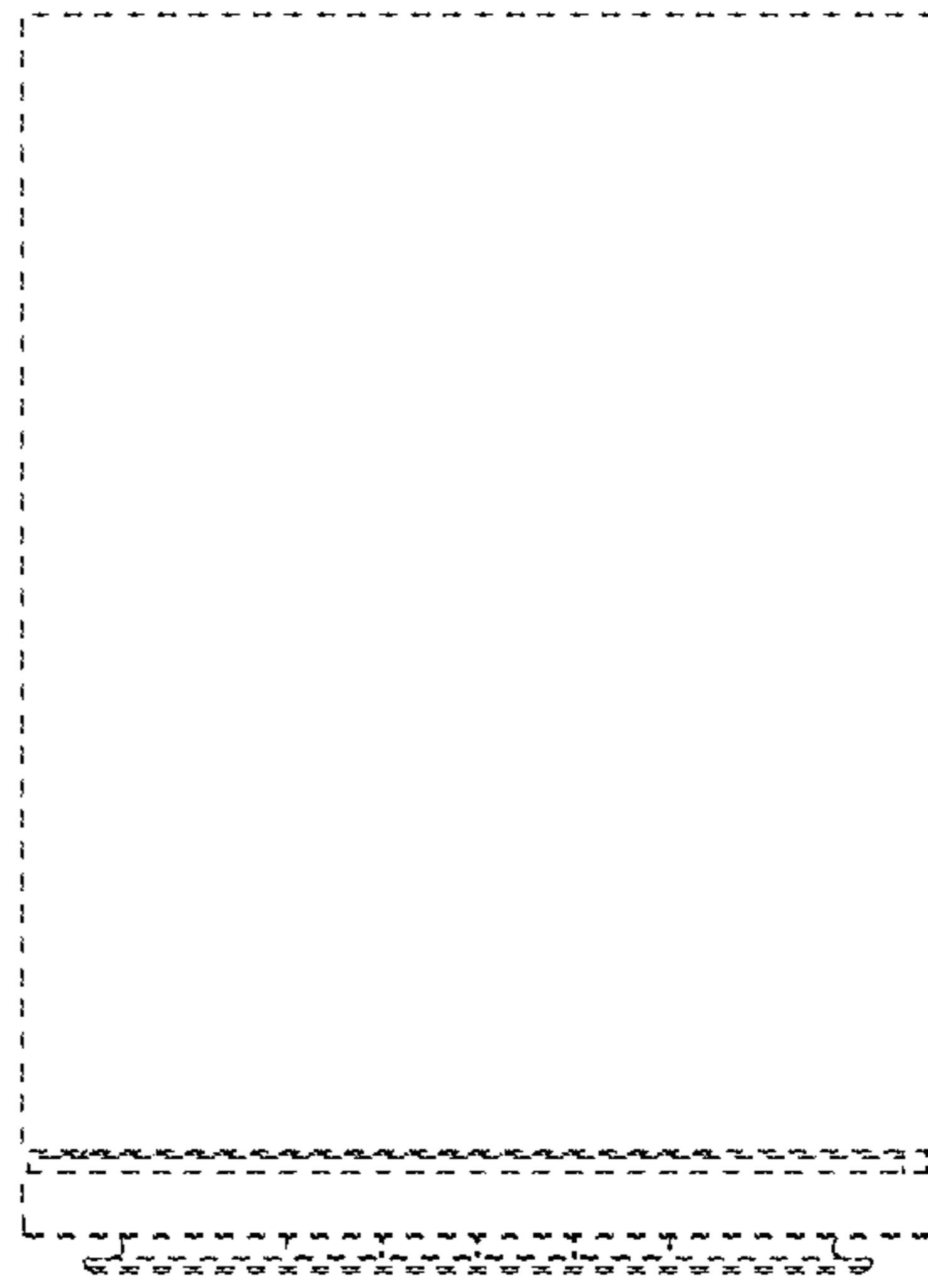



FIG. 7

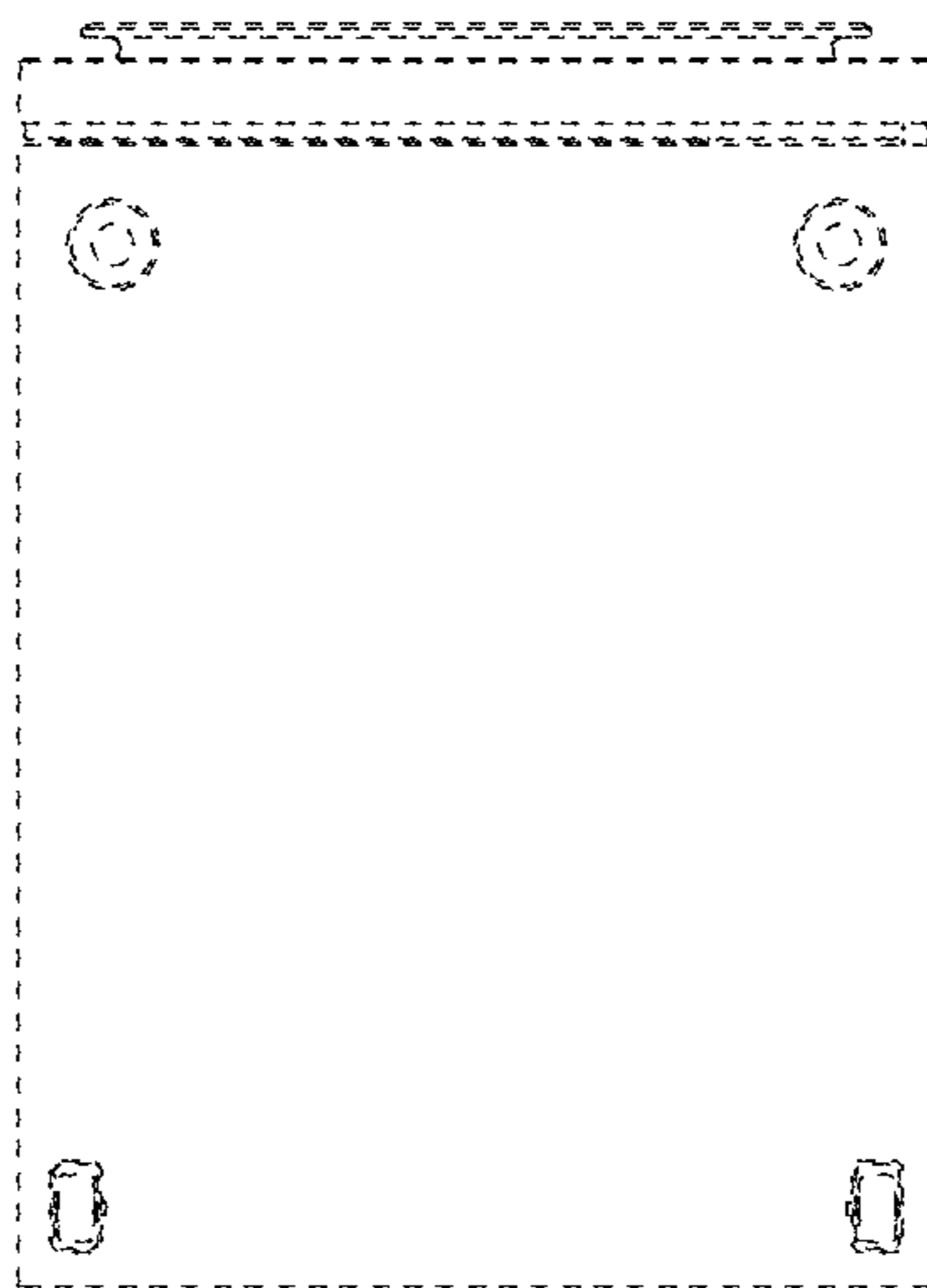

FIG. 8

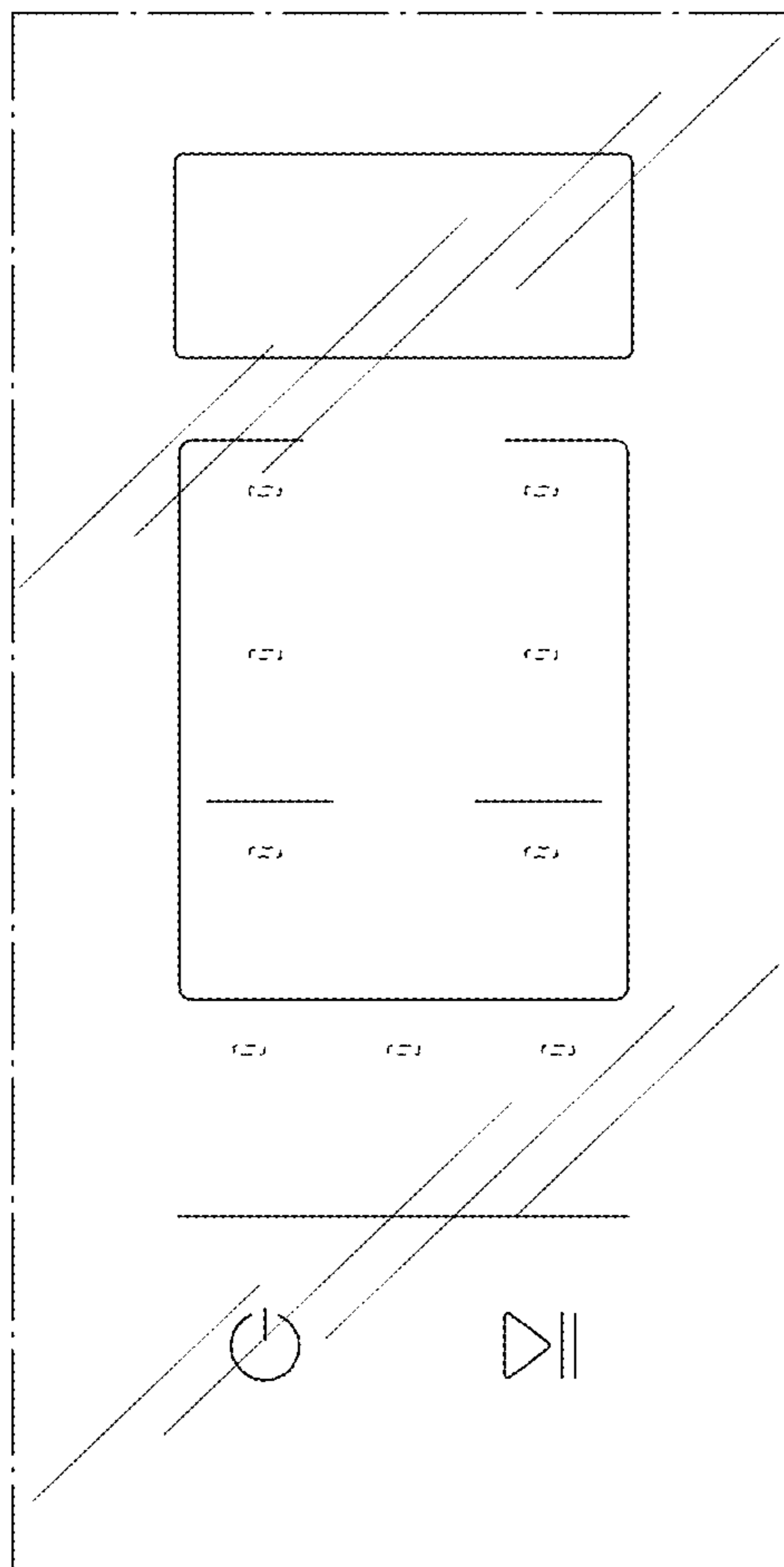

FIG. 9

