



US00D918495S

(12) **United States Design Patent** (10) **Patent No.:** **US D918,495 S**  
**Callahan et al.** (45) **Date of Patent:** **\*\* May 4, 2021**

(54) **COUNTERTOP DISHWASHER**

FOREIGN PATENT DOCUMENTS

(71) Applicant: **Heatworks Technologies, Inc.**,  
Sullivan's Island, SC (US)

CN 3173335 D 1/2001  
KR 300423970 9/2006  
RU 00117732 \* 11/2019

(72) Inventors: **Jeremiah M. Callahan**, Sullivan's  
Island, SC (US); **Adam C. Wrigley**,  
Brooklyn, NY (US); **Inna Lobel**, New  
York, NY (US); **Jung Soo Park**,  
Brooklyn, NY (US); **Alexander C.**  
**Calkins**, Portland, OR (US);  
**Christopher B. Crowley**, Long Island  
City, NY (US); **Reid A. Schlegel**,  
Brooklyn, NY (US)

OTHER PUBLICATIONS

Cleaning Tools for a Tiny Apartment—The New York Times, article  
date Mar. 23, 2018, site visited Mar. 9, 2020, <https://www.nytimes.com/2018/03/23/realestate/cleaning-small-apartment.html>.\*

(Continued)

*Primary Examiner* — John R Yeh  
(74) *Attorney, Agent, or Firm* — Lerner, David,  
Littenberg, Krumholz & Mentlik, LLP

(73) Assignee: **Heatworks Technologies, Inc.**,  
Sullivan's Island, SC (US)

(57) **CLAIM**

(\*\*) Term: **15 Years**

The ornamental design for a countertop dishwasher, as  
shown and described.

(21) Appl. No.: **29/655,735**

(22) Filed: **Jul. 6, 2018**

**DESCRIPTION**

(51) **LOC (13) Cl.** ..... **15-05**

(52) **U.S. Cl.**  
USPC ..... **D32/2**

(58) **Field of Classification Search**  
USPC ..... D32/2-3, 6, 8  
CPC ..... A47L 15/42; A47L 15/48; A47L 15/14;  
A47L 15/23  
See application file for complete search history.

FIG. 1 is a front perspective view of a countertop dishwasher  
according to our design;  
FIG. 2 is a front elevation view thereof;  
FIG. 3 is a rear elevation view thereof;  
FIG. 4 is a right side elevation view thereof;  
FIG. 5 is a left side elevation view thereof;  
FIG. 6 is a top plan view thereof;  
FIG. 7 is a bottom plan view thereof;  
FIG. 8 is a front bottom perspective view thereof; and,  
FIG. 9 is a front perspective view showing an example use  
thereof.

(56) **References Cited**

U.S. PATENT DOCUMENTS

3,460,878 A \* 8/1969 Appel ..... A47L 15/0089  
312/297  
3,465,761 A \* 9/1969 Grunewald ..... A47L 15/0089  
134/58 D  
D310,616 S \* 9/1990 Murai ..... D7/351

The broken lines in FIG. 9 illustrate dishes and glasses that  
are environment features and that form no part of the  
claimed design. All other broken lines depict portions of the  
countertop dishwasher that form no part of the claimed  
design. The diagonal lines and curved lines on the surfaces  
of the countertop dishwasher represent a transparent surface.

(Continued)

(Continued)

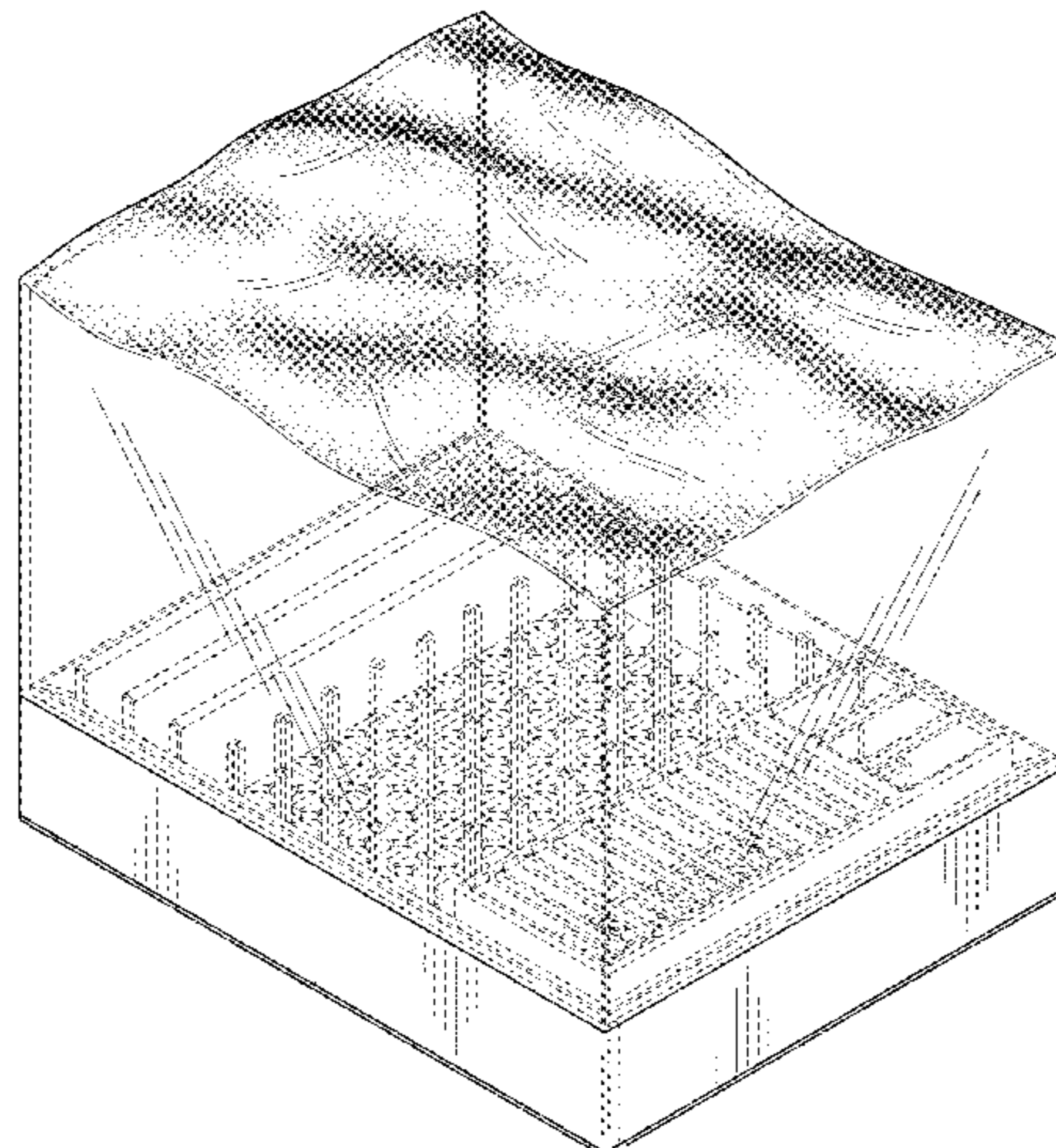

The stipple shading in FIGS. 1-9 is intended to illustrate the surface contours of the transparent top surface of the countertop dishwasher.

**1 Claim, 6 Drawing Sheets**

(56)

**References Cited**

U.S. PATENT DOCUMENTS

D360,103 S *	7/1995	Kim	.....	D7/351
5,518,014 A *	5/1996	McEachen	.....	A47L 15/0089 134/104.4
D403,471 S *	12/1998	Brace	.....	D32/2
D431,957 S *	10/2000	Taira	.....	D7/351
D443,873 S *	6/2001	Comisky	.....	D14/230
D452,965 S *	1/2002	Comisky	.....	D14/230
D453,152 S *	1/2002	Comisky	.....	D14/230
D453,925 S *	2/2002	Comisky	.....	D14/230
D453,927 S *	2/2002	Comisky	.....	D14/230
D460,659 S *	7/2002	Hessen	.....	D7/351
D463,408 S *	9/2002	Comisky	.....	D14/231
D554,305 S *	10/2007	Pietruska	.....	D32/2
D560,422 S *	1/2008	Kim	.....	D7/351
D587,864 S	3/2009	Jung et al.		
D620,211 S *	7/2010	Shail	.....	D32/25
D629,168 S *	12/2010	Park	.....	D32/25

D633,670 S *	3/2011	Grutzke	.....	D32/25
D639,105 S *	6/2011	Shin	.....	D7/351
D703,395 S	4/2014	Choi et al.		
D704,909 S *	5/2014	Jeon	.....	D32/25
D712,694 S *	9/2014	Kim	.....	D7/351
D804,749 S *	12/2017	Tong	.....	D32/2
D827,224 S	8/2018	Lee et al.		
D828,655 S *	9/2018	Tong	.....	D32/2
D845,564 S *	4/2019	Tong	.....	D32/2
D864,504 S	10/2019	Kim et al.		
2010/0139700 A1 *	6/2010	Purtilo	.....	A47L 15/14 134/25.2

OTHER PUBLICATIONS

Tetra Countertop Dishwasher Specifications—MyHeatworks.com, website 2020, <https://myheatworks.com/pages/tetra-specs>, site visited Mar. 9, 2020.\*

Countertop Dishwasher publicly disclosed by Applicant, Heatworks Technologies Inc., on Jan. 7, 2018, at the CES Consumer Technology Association Trade Show in Las Vegas, Nevada. (Image of Exhibit Booth attached as Exhibit A.).

Design U.S. Appl. No. 29/675,676, filed Jan. 4, 2019 entitled “Countertop Dishwasher” (Not Yet Published; CIP (70)).

Callahan, J.M. et al., U.S. Appl. No. 29/760,839, filed Dec. 4, 2020, titled “Countertop Dishwasher.”.

\* cited by examiner



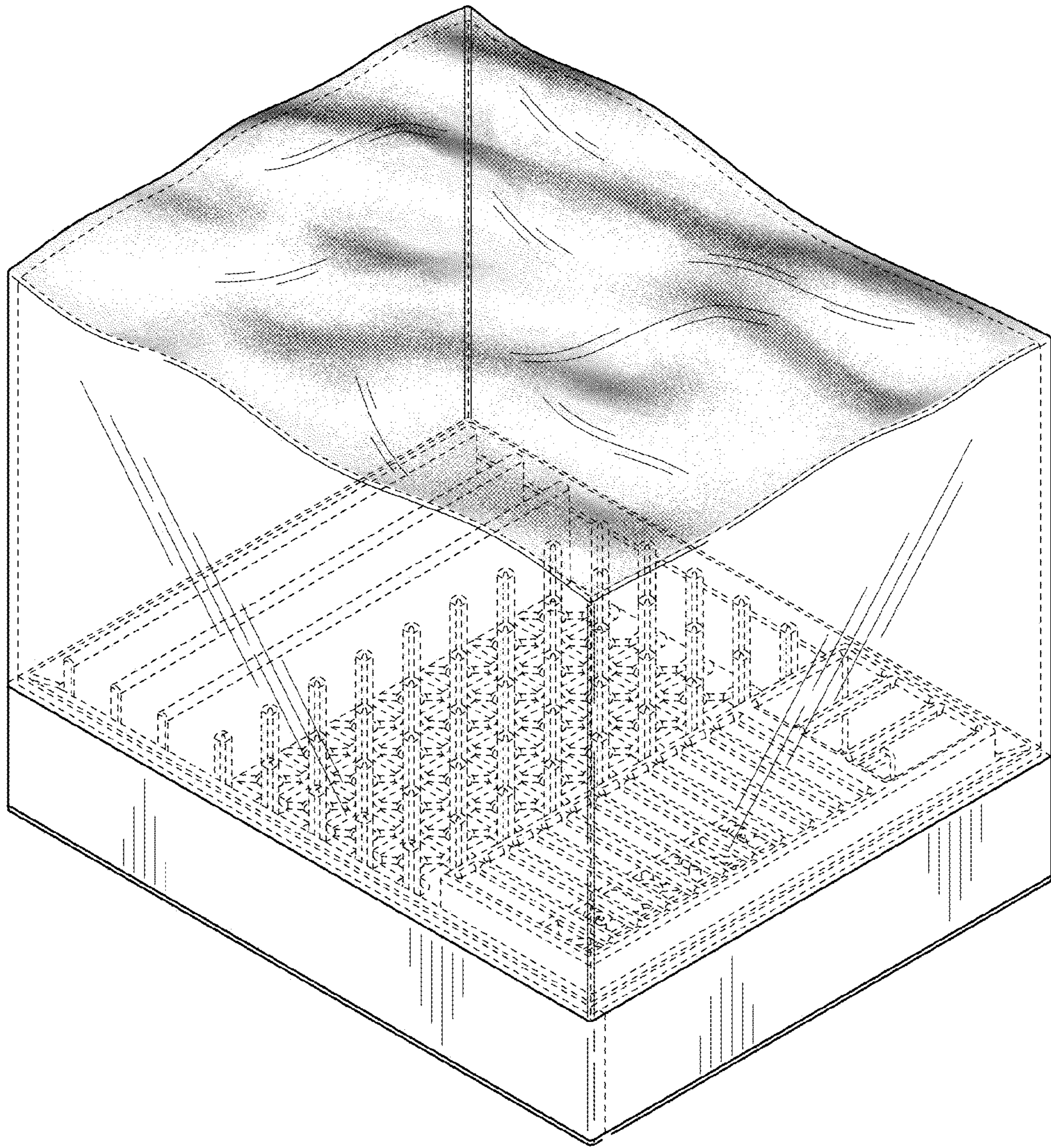

FIG. 1

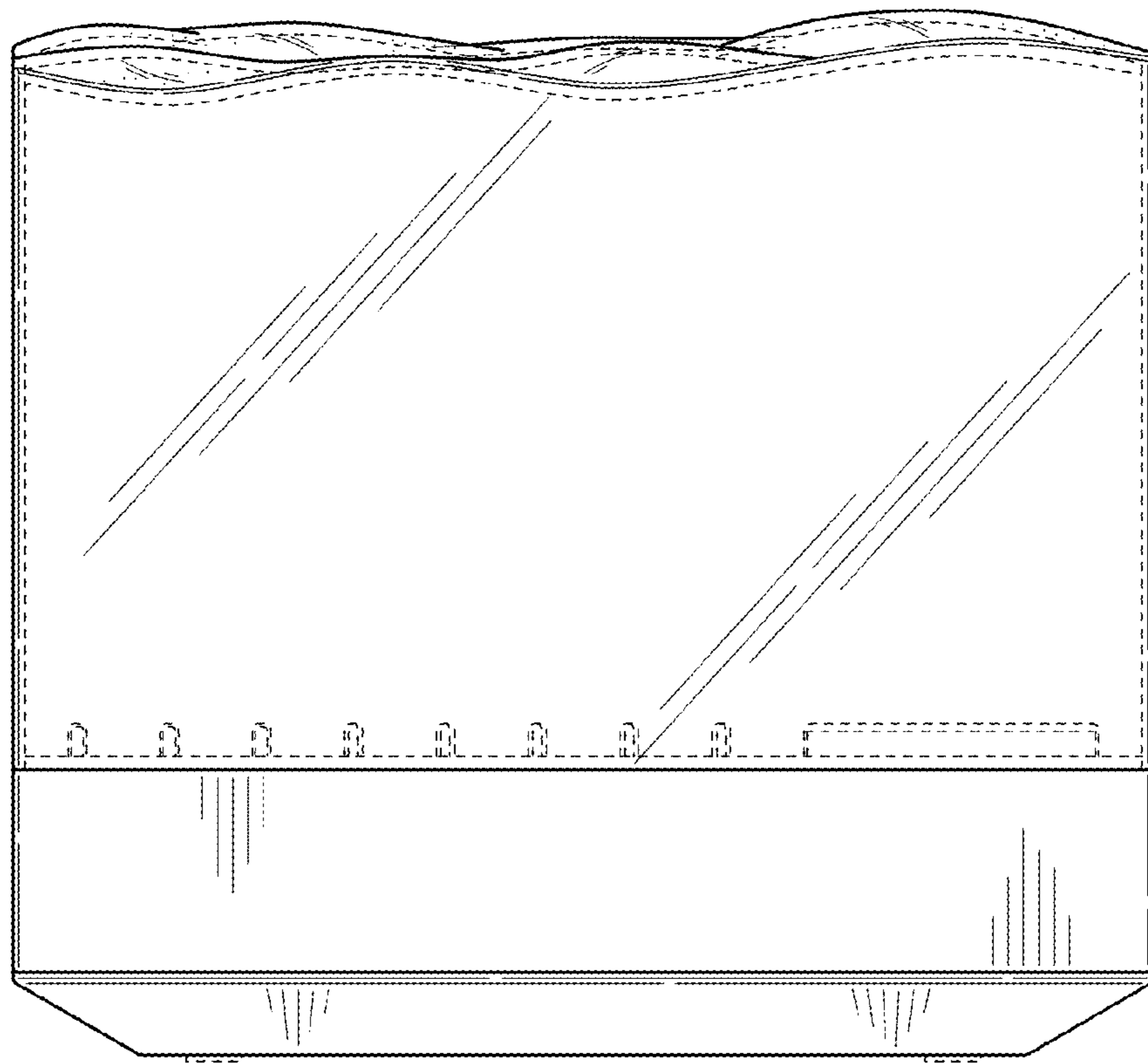

FIG. 2

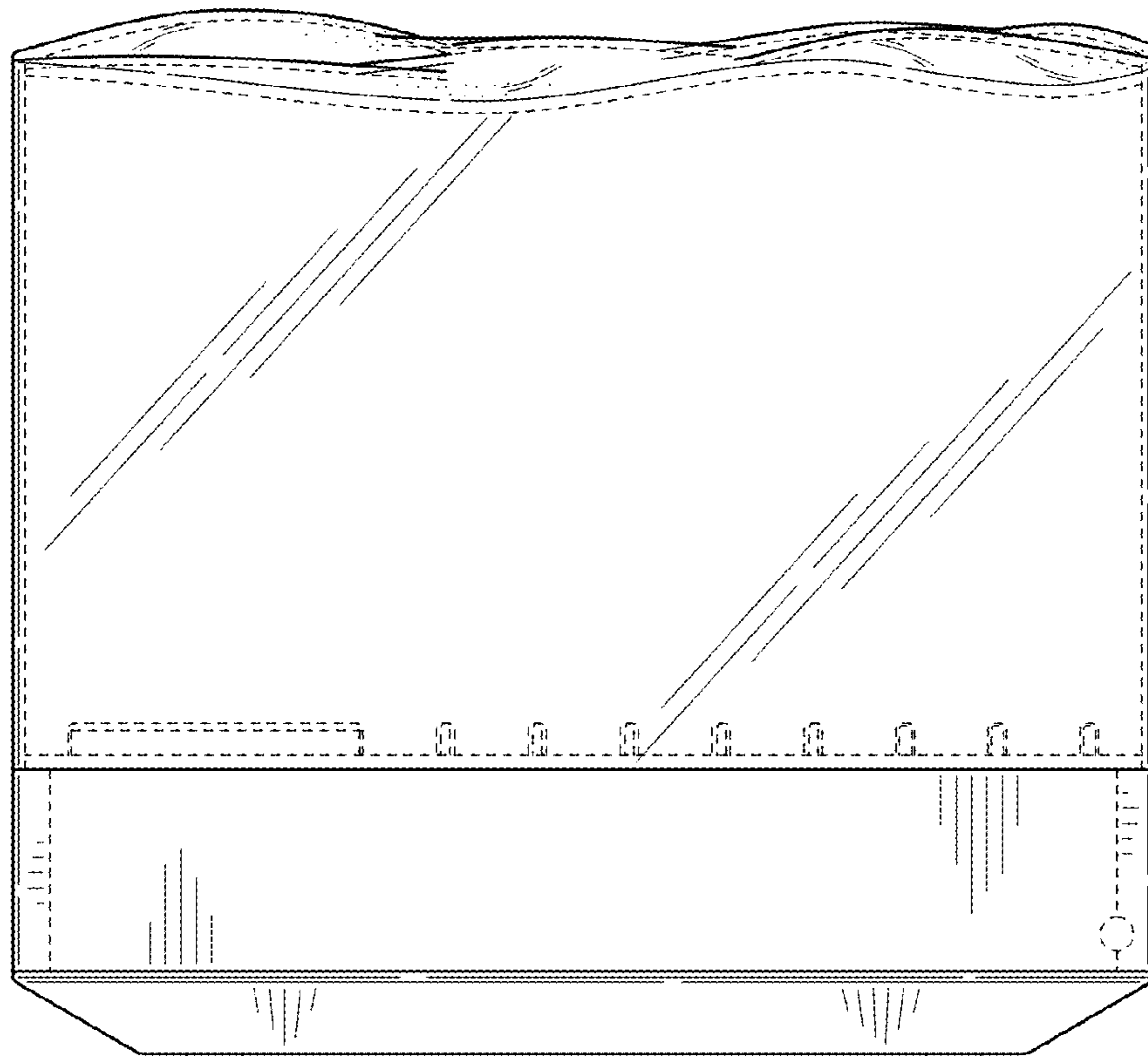

FIG. 3



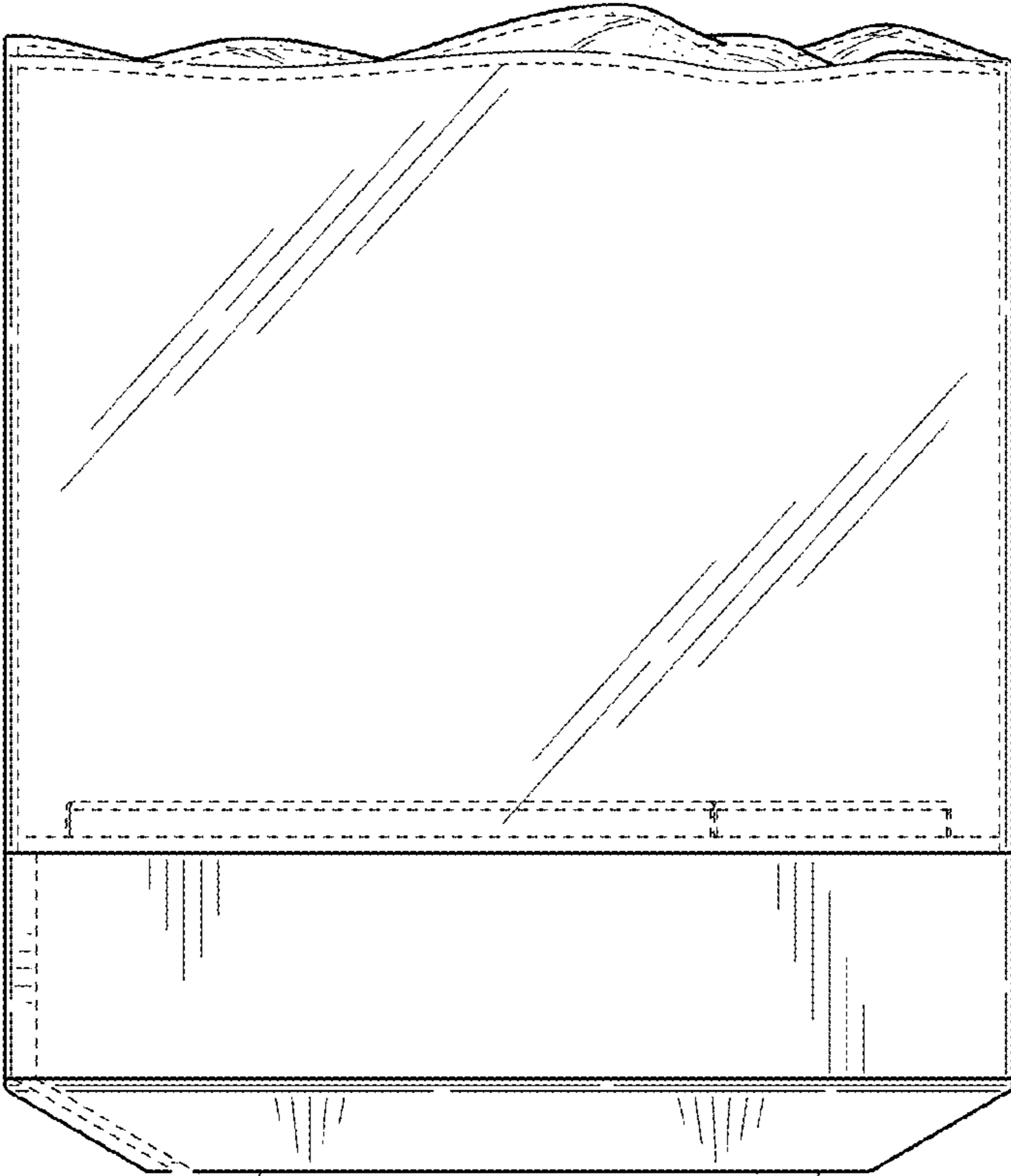

FIG. 4

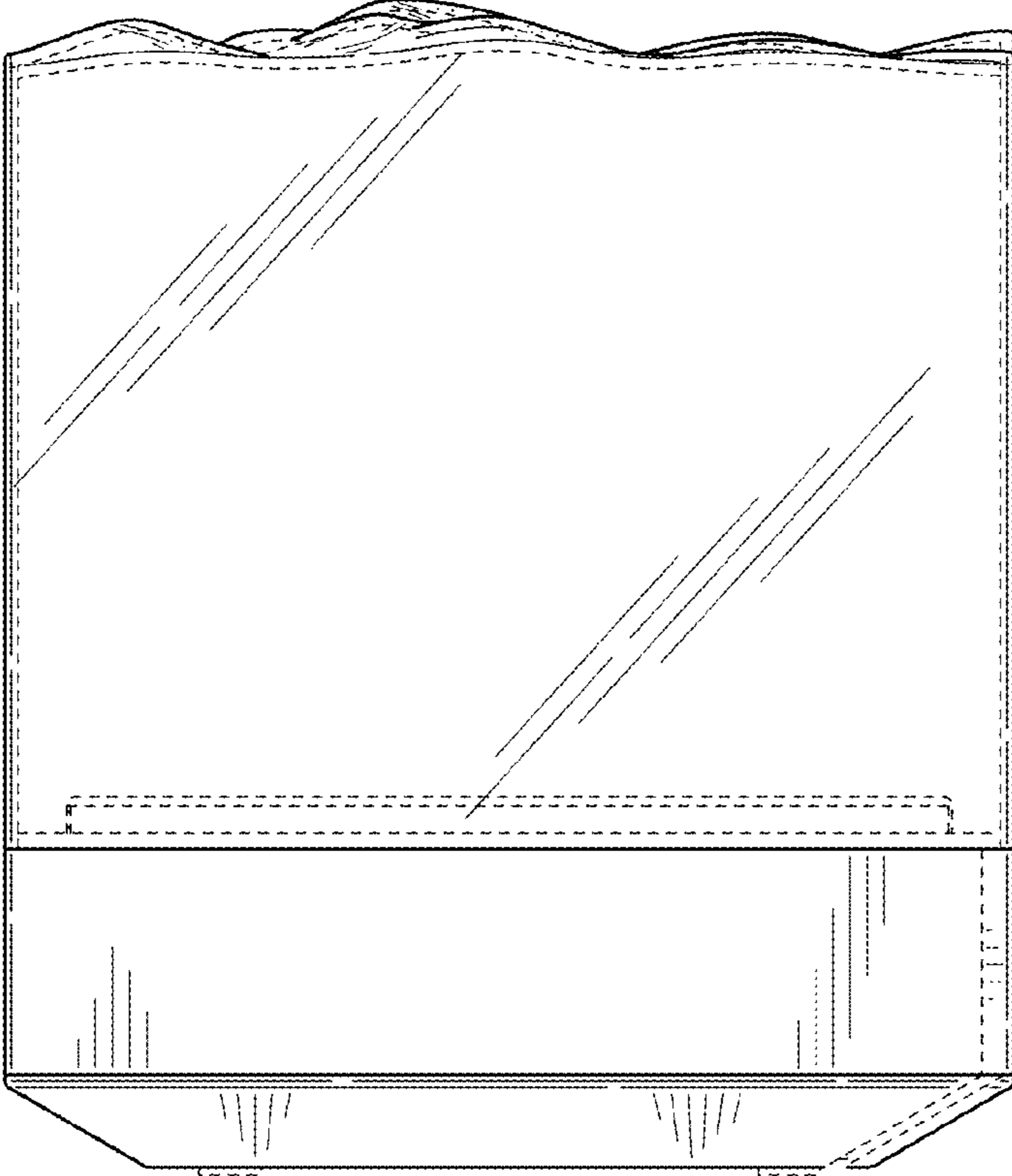

FIG. 5

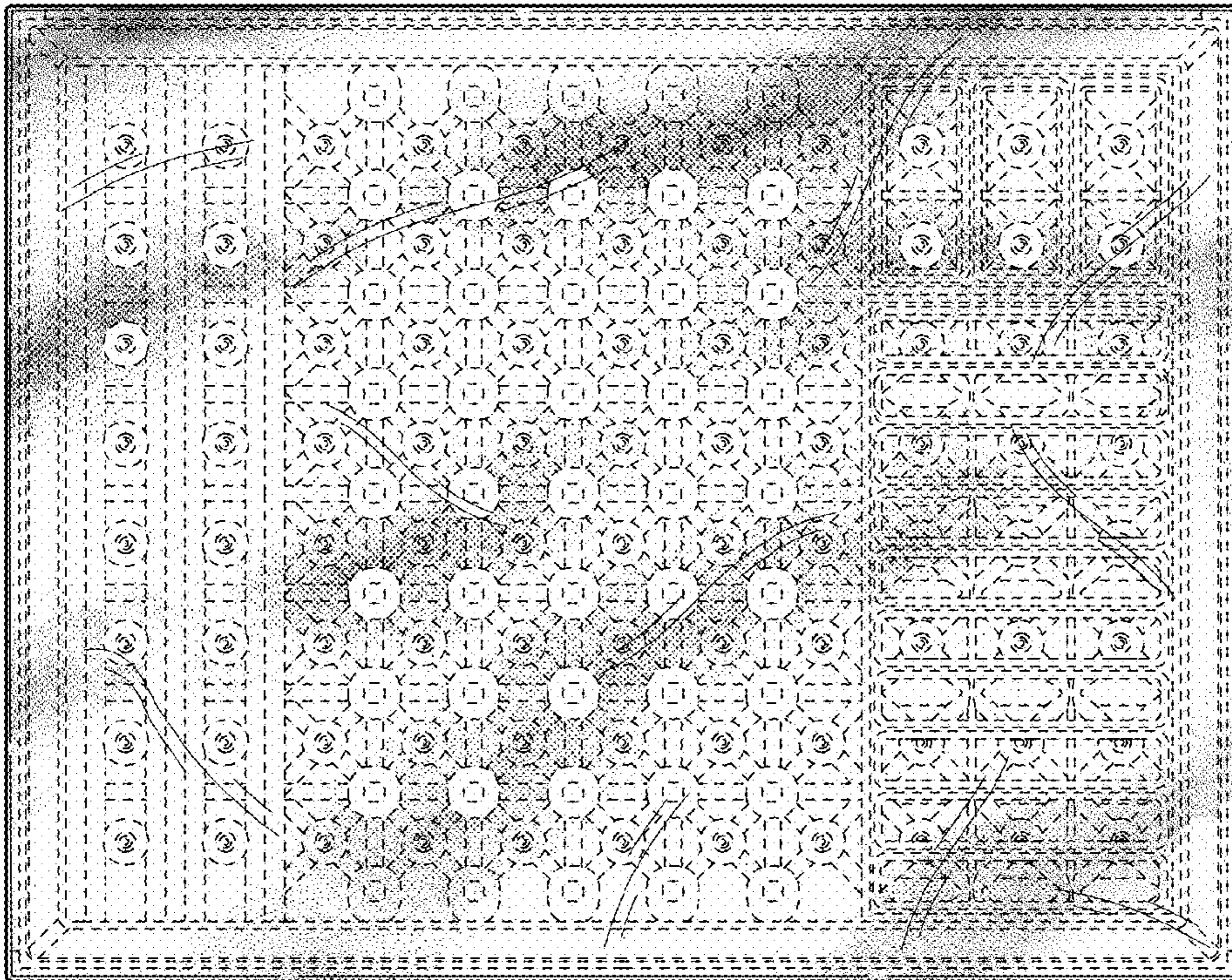

FIG. 6

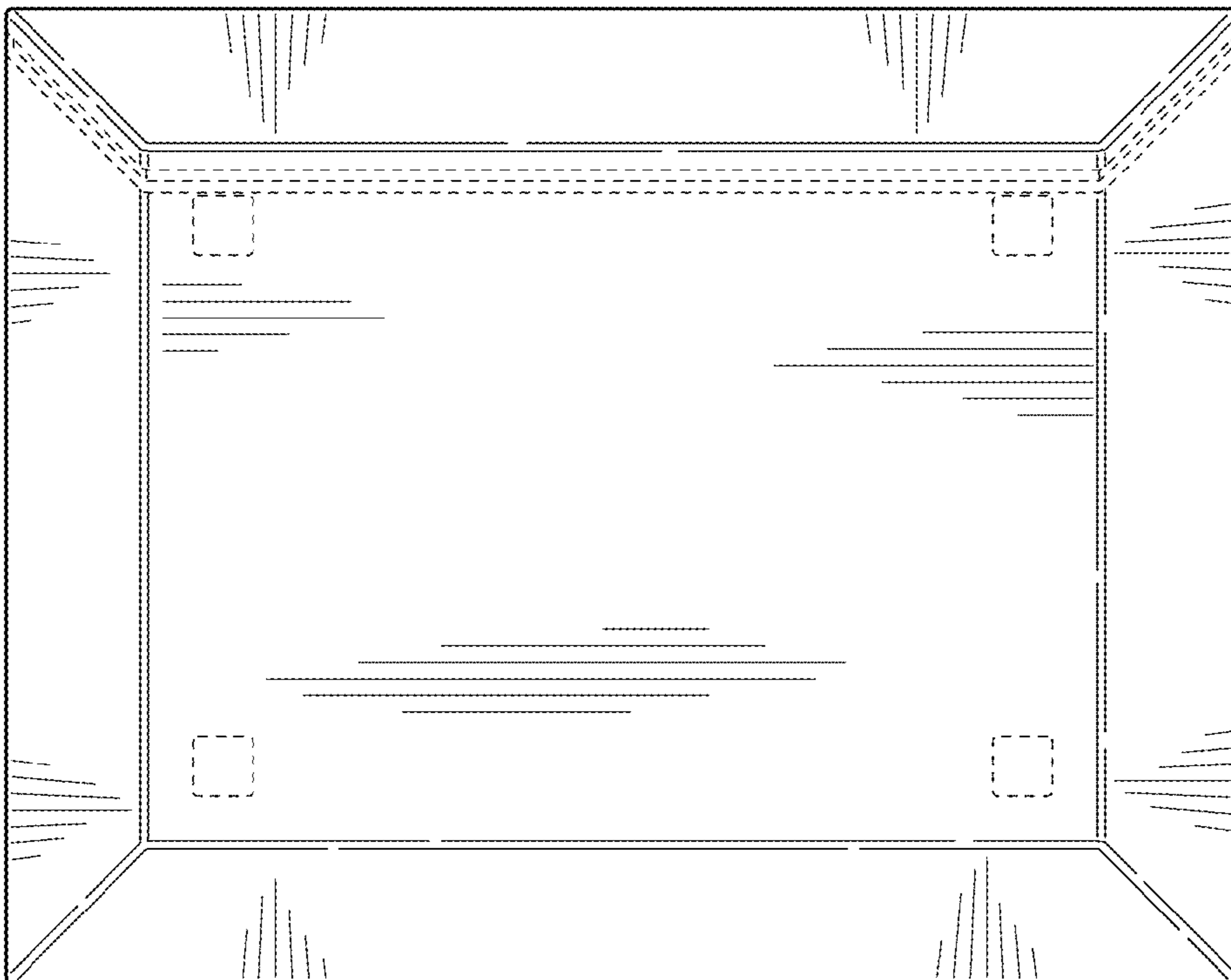

FIG. 7



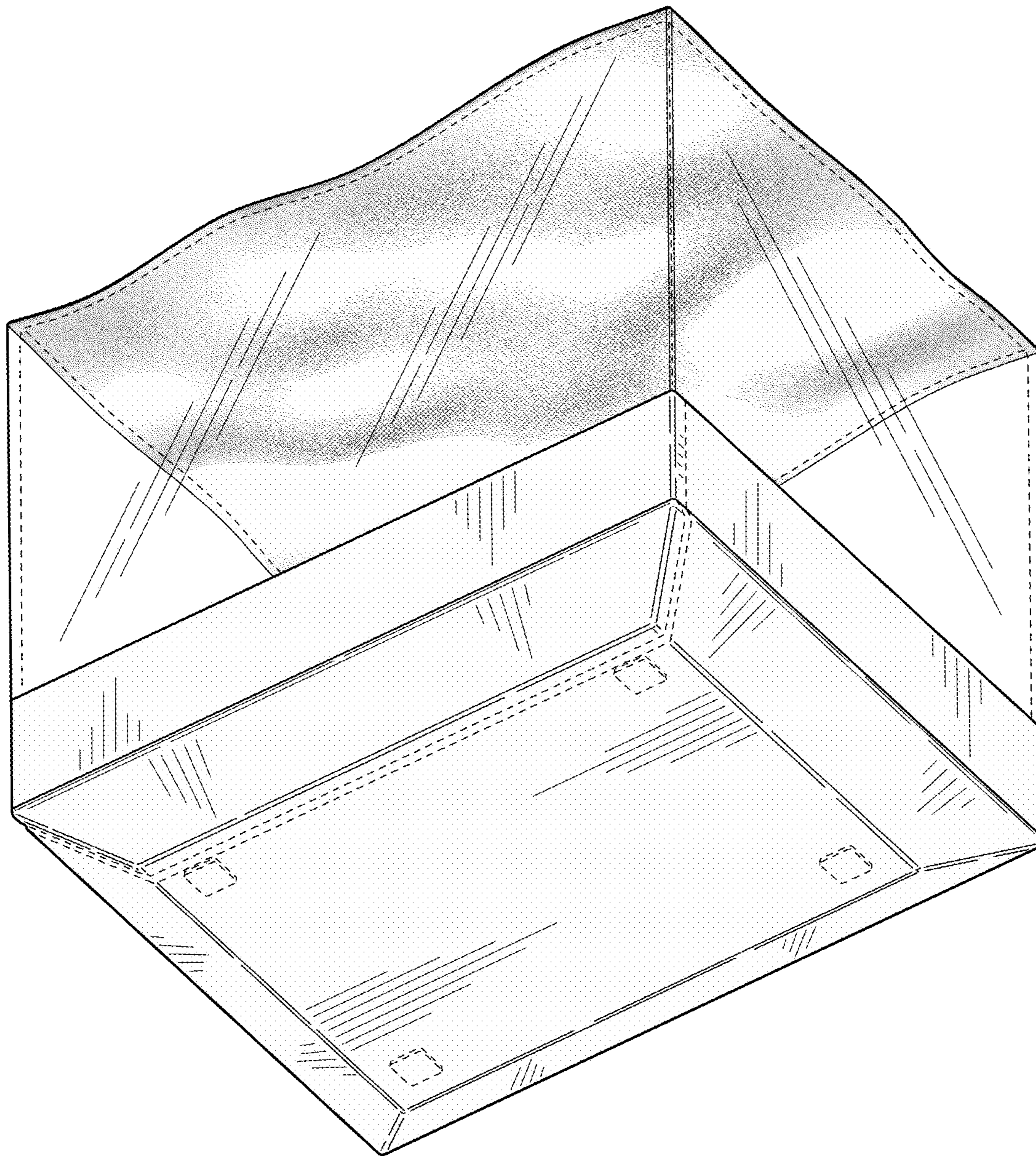

FIG. 8



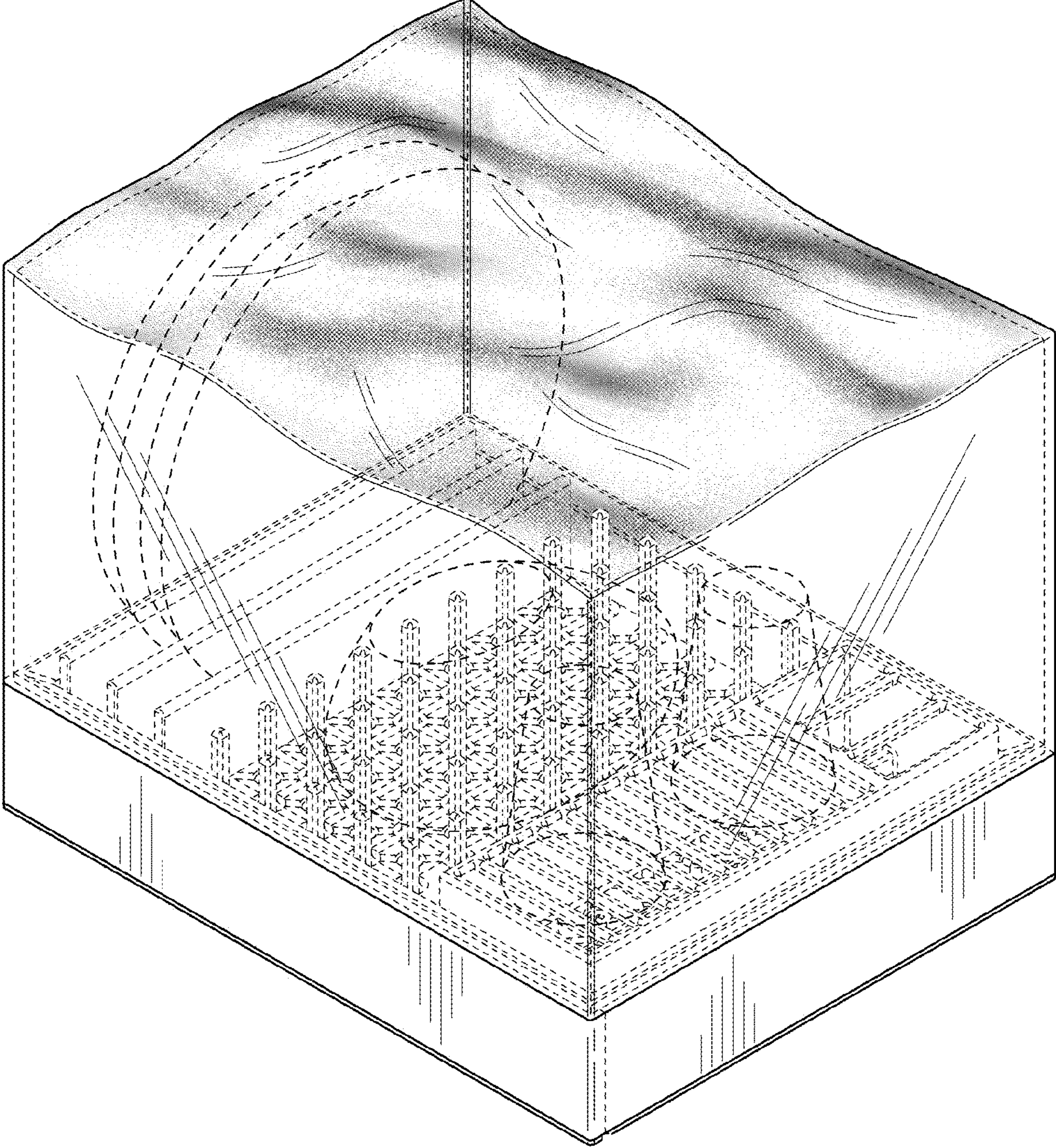

FIG. 9