



US00D918428S

(12) **United States Design Patent** (10) **Patent No.:** **US D918,428 S**
Nelson et al. (45) **Date of Patent:** **** May 4, 2021**

(54) **WINDOW COMPONENT EXTRUSION**

(71) Applicant: **JELD-WEN, Inc.**, Charlotte, NC (US)

(72) Inventors: **Jacob Nelson**, Klamath Falls, OR (US);
Yoshua Gombo, Seattle, WA (US);
David Belau, Klamath Falls, OR (US);
Ryan Schroeder, Klamath Falls, OR (US);
Jerry Jones, Klamath Falls, OR (US)

(73) Assignee: **JELD-WEN, Inc.**, Charlotte, NC (US)

(**) Term: **15 Years**

(21) Appl. No.: **29/710,178**

(22) Filed: **Oct. 21, 2019**

(51) **LOC (13) Cl.** **25-01**

(52) **U.S. Cl.**

USPC **D25/124**

(58) **Field of Classification Search**

USPC D25/35, 102, 119-125, 164; D8/354,
D8/373, 374, 376, 377

CPC E06B 1/02; E06B 1/04; E06B 1/12; E06B
1/14; E06B 1/16; E06B 1/26; E06B 1/28;
E06B 1/36; E06B 1/363; E06B 1/366;
E06B 1/38; E06B 1/40; E06B 1/52; E06B
1/524; E06B 1/56; E06B 1/62; E06B
1/68; E06B 3/04; E06B 3/06; E06B 3/24;
E06B 3/26; E06B 3/30; E06B 3/301;
E06B 3/306; E06B 3/308

See application file for complete search history.

(56) **References Cited**

U.S. PATENT DOCUMENTS

4,304,081 A * 12/1981 Dawson E06B 3/305
52/656.5
D382,979 S * 8/1997 DiGiorgio D25/124

D392,395 S * 3/1998 Porter D25/124
D395,526 S * 6/1998 Porter D25/124
D401,359 S * 11/1998 Porter D25/124
D414,882 S * 10/1999 DiGiorgio D25/124
D471,994 S * 3/2003 Chaney D25/124
D503,812 S * 4/2005 Habeck D25/124
D557,826 S * 12/2007 Willman D25/124
D603,977 S * 11/2009 Wickland D25/124
D627,489 S * 11/2010 Stephens D25/124
D679,386 S * 4/2013 Morton D25/124
D783,866 S * 4/2017 Chaney D25/124

* cited by examiner

Primary Examiner — Llorelys Martinez

(74) *Attorney, Agent, or Firm* — Stoel Rives LLP

(57) **CLAIM**

The ornamental design for a window component extrusion, as shown and described.

DESCRIPTION

FIG. 1 is a front perspective view of a window component extrusion showing our new design.

FIG. 2 is a rear perspective view thereof.

FIG. 3 is a front elevation view thereof.

FIG. 4 is a rear elevation view thereof.

FIG. 5 is a left side elevation view thereof.

FIG. 6 is a right side elevation view thereof.

FIG. 7 is a top plan view thereof; and,

FIG. 8 is a bottom plan view thereof.

In FIGS. 1-4, 7, and 8, the window component extrusion is shown with a symbolic break in its length. The appearance of any portion of the window component extrusion between the break lines forms no part of the claimed design.

1 Claim, 5 Drawing Sheets

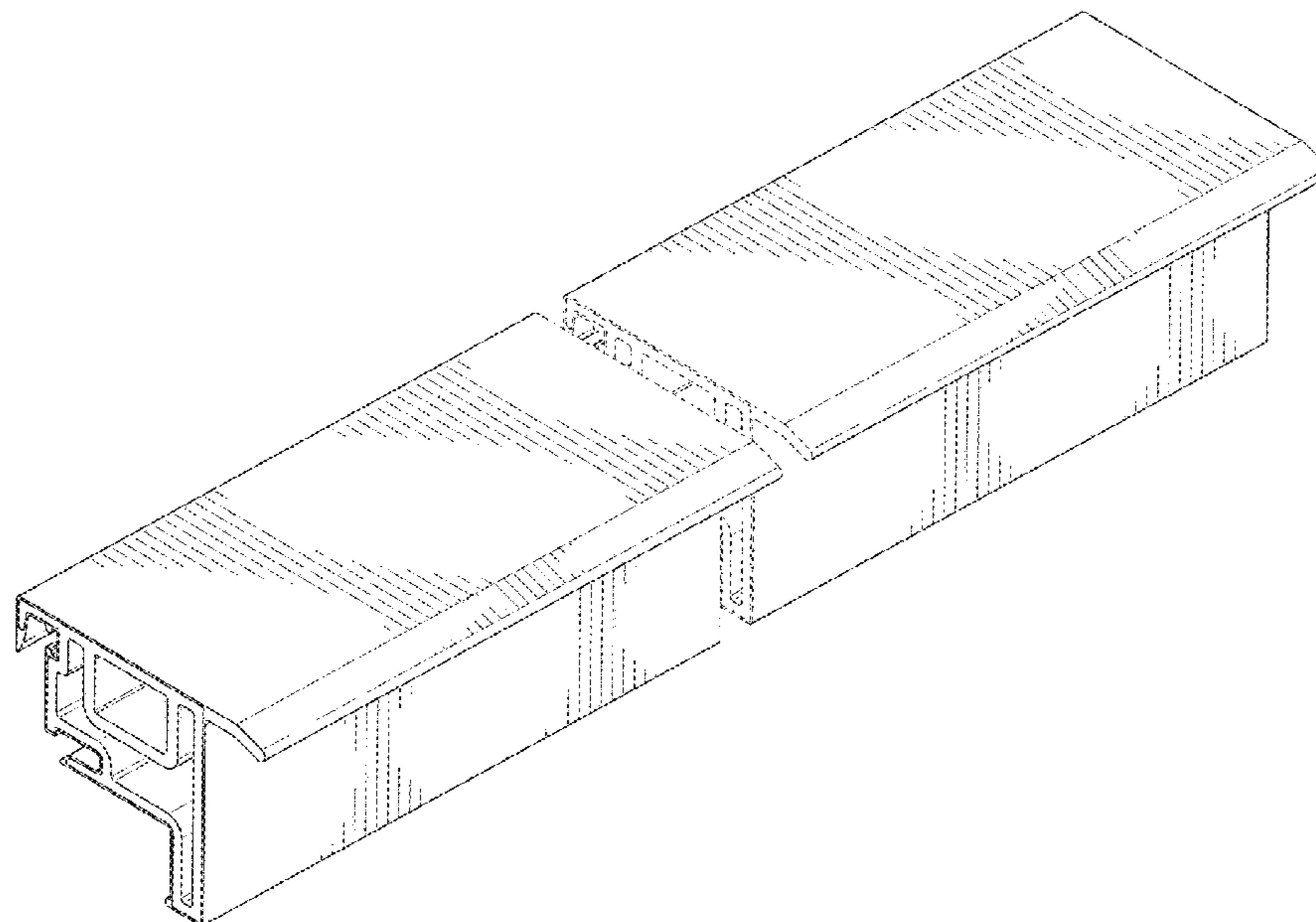

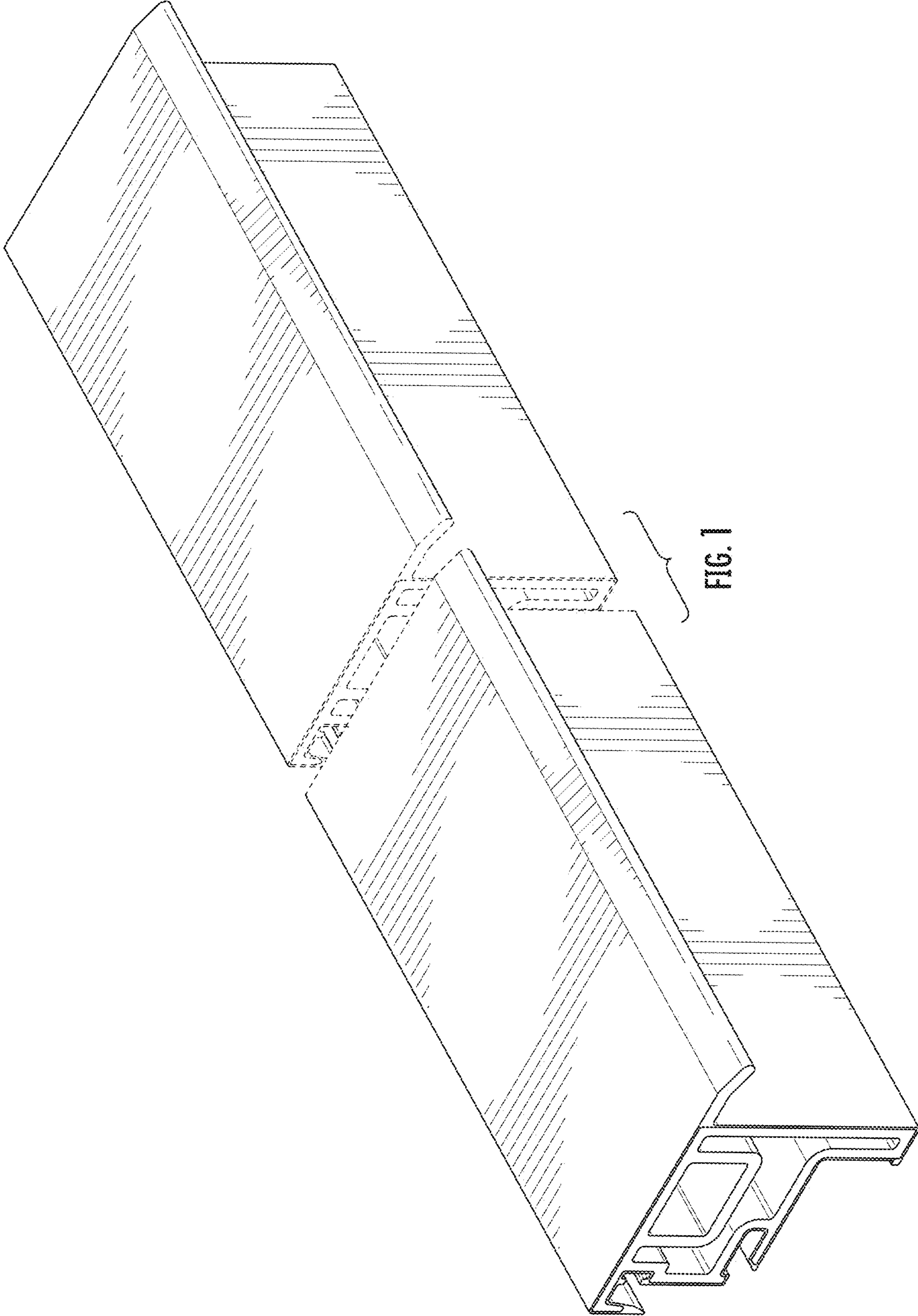

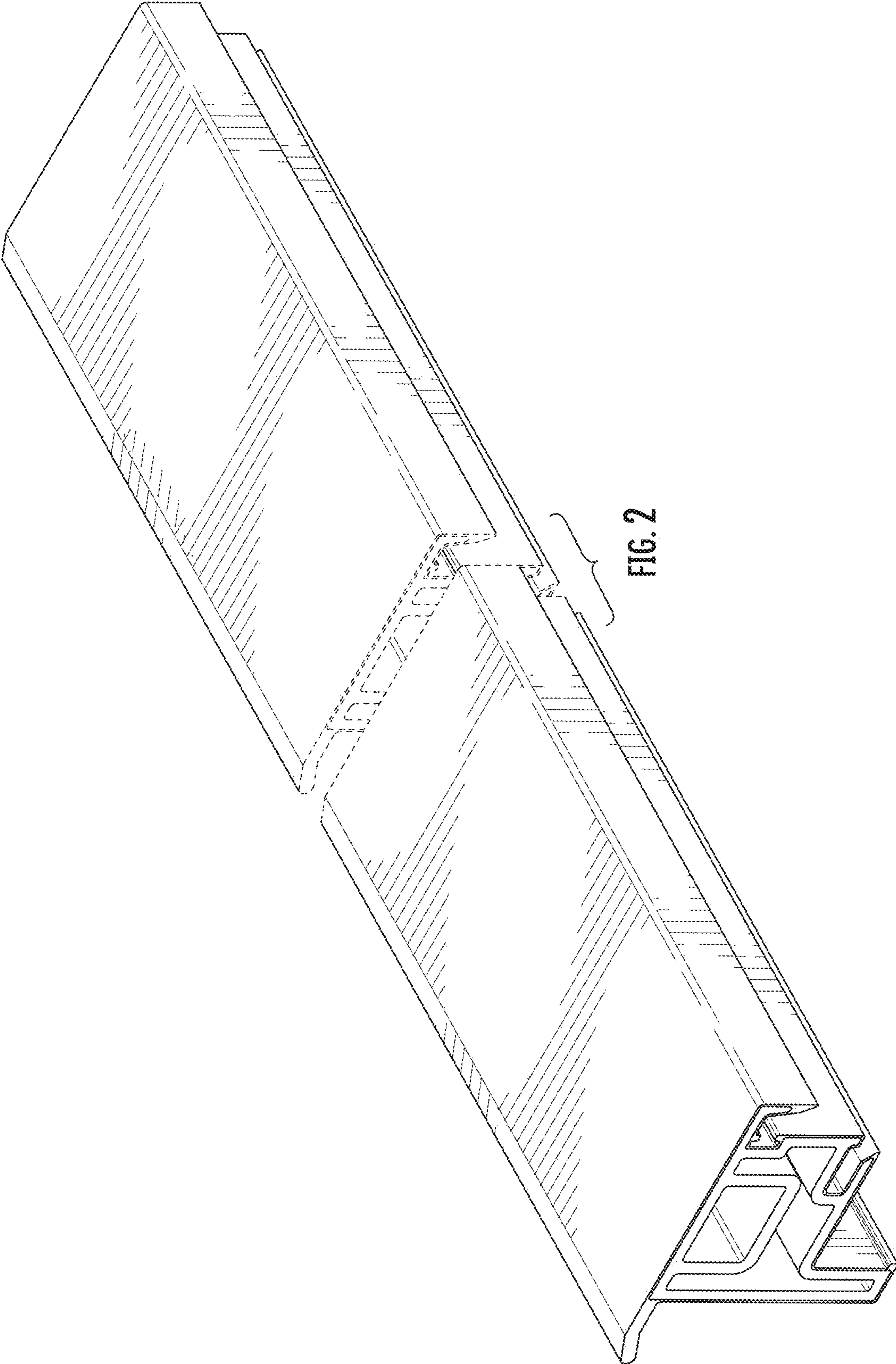

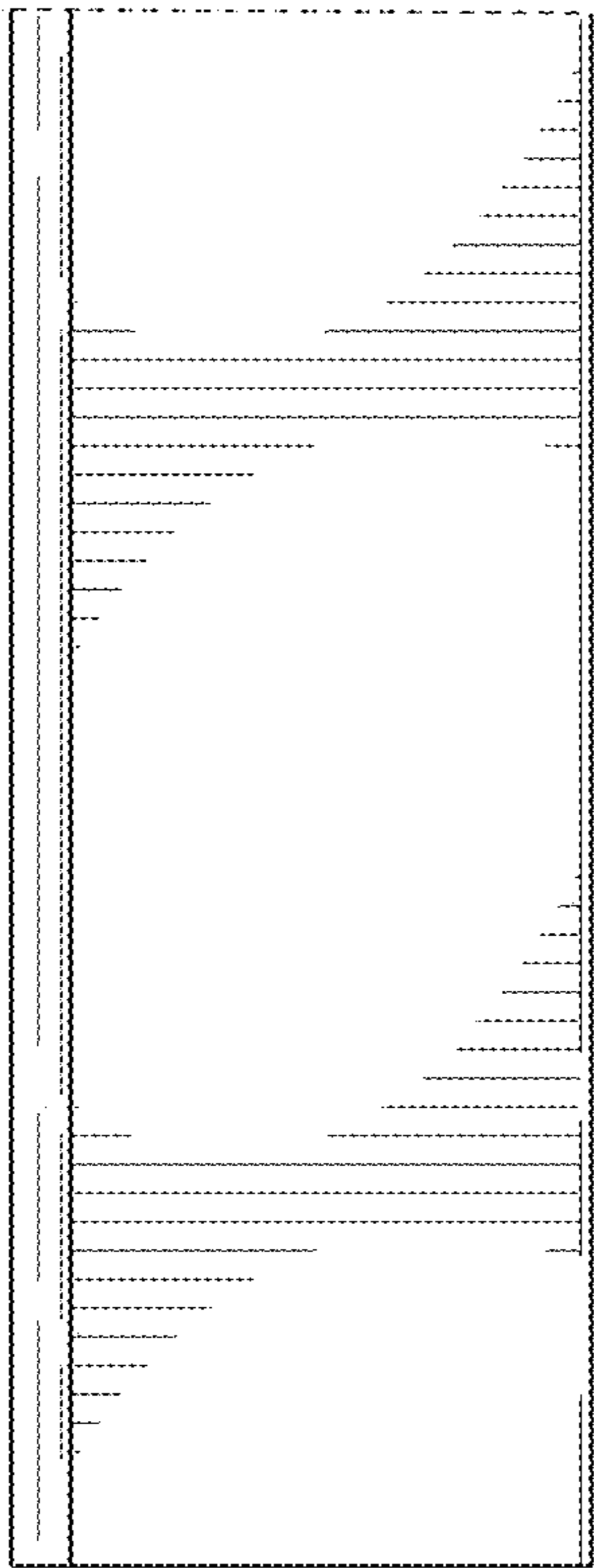
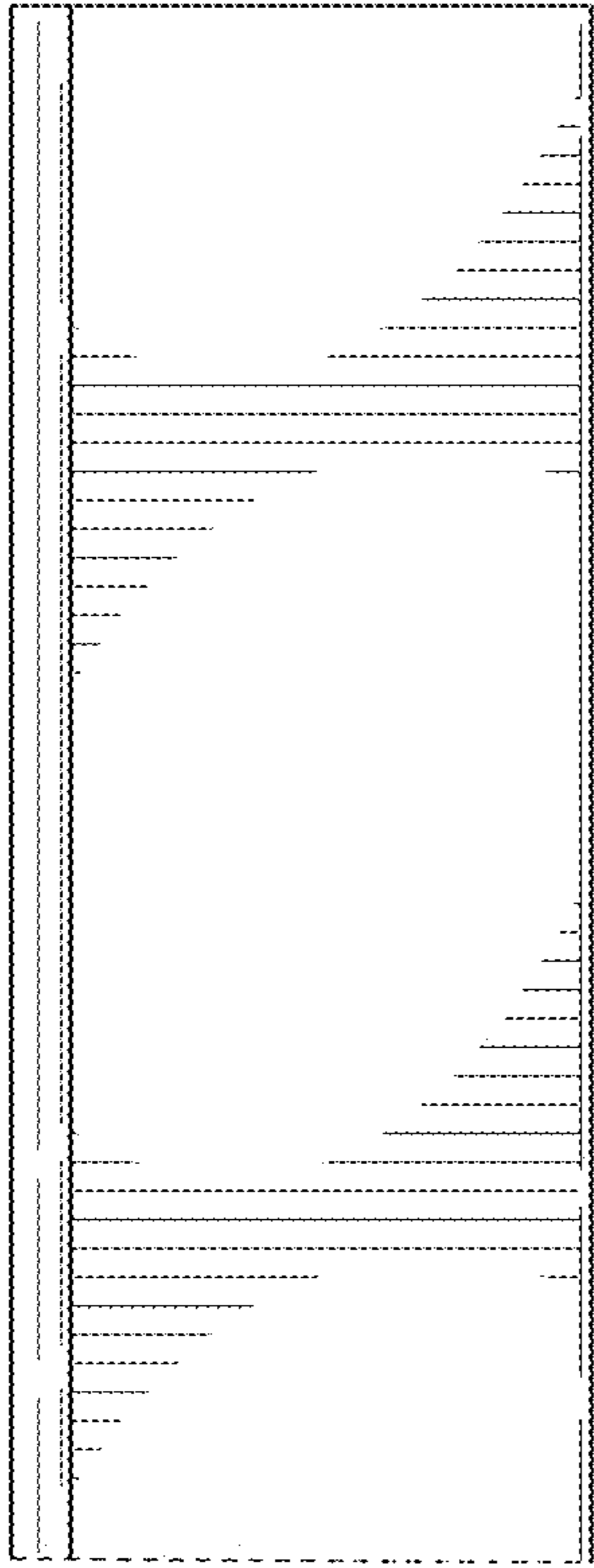

FIG. 3

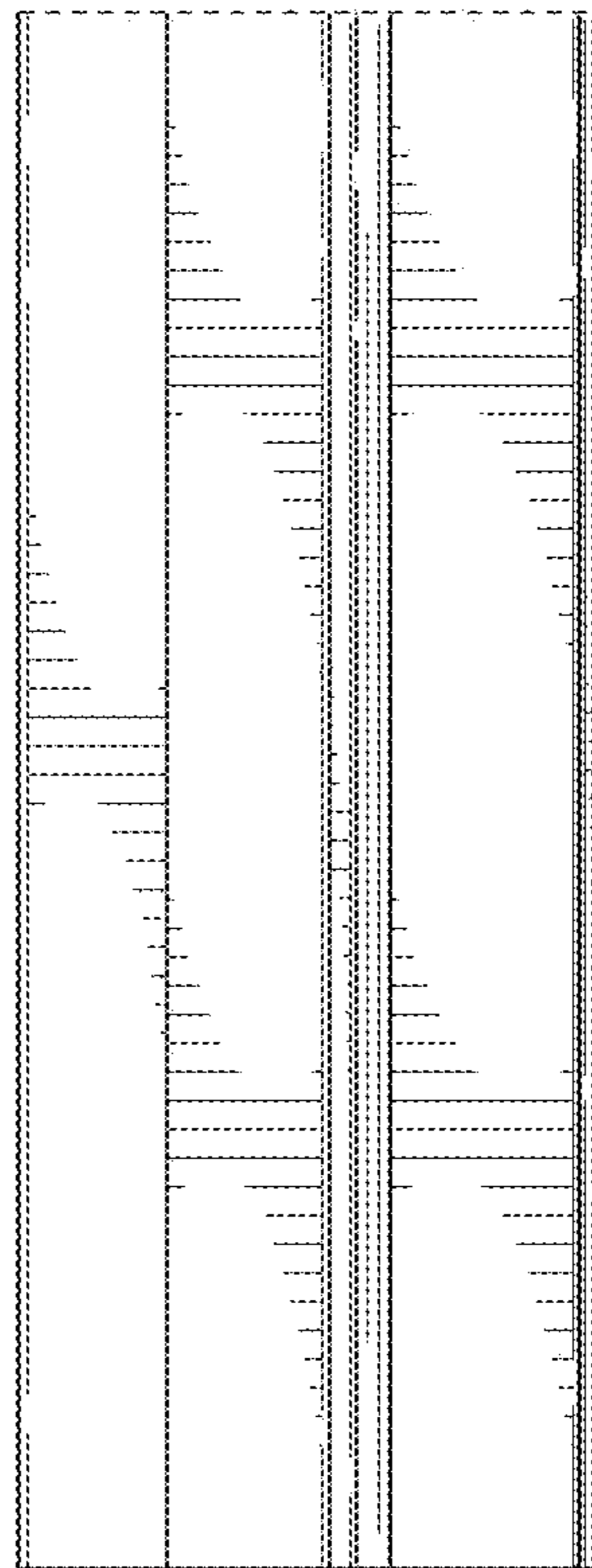
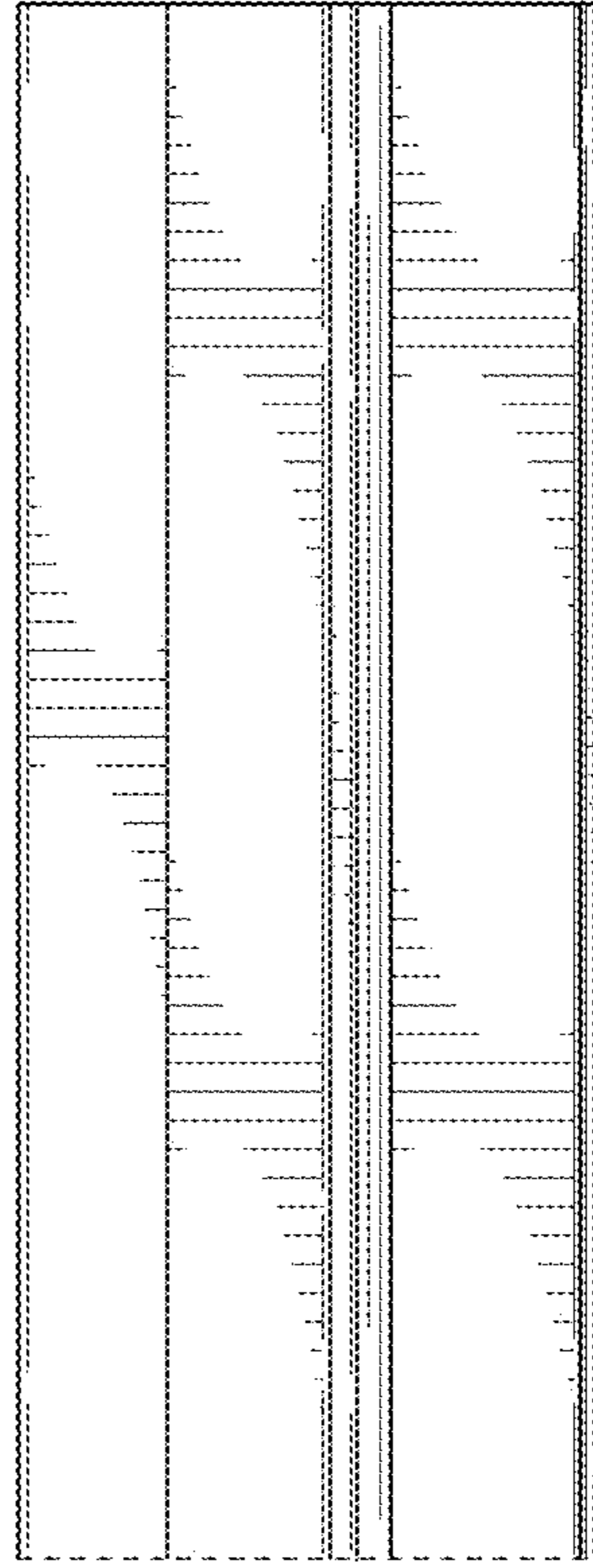

FIG. 4

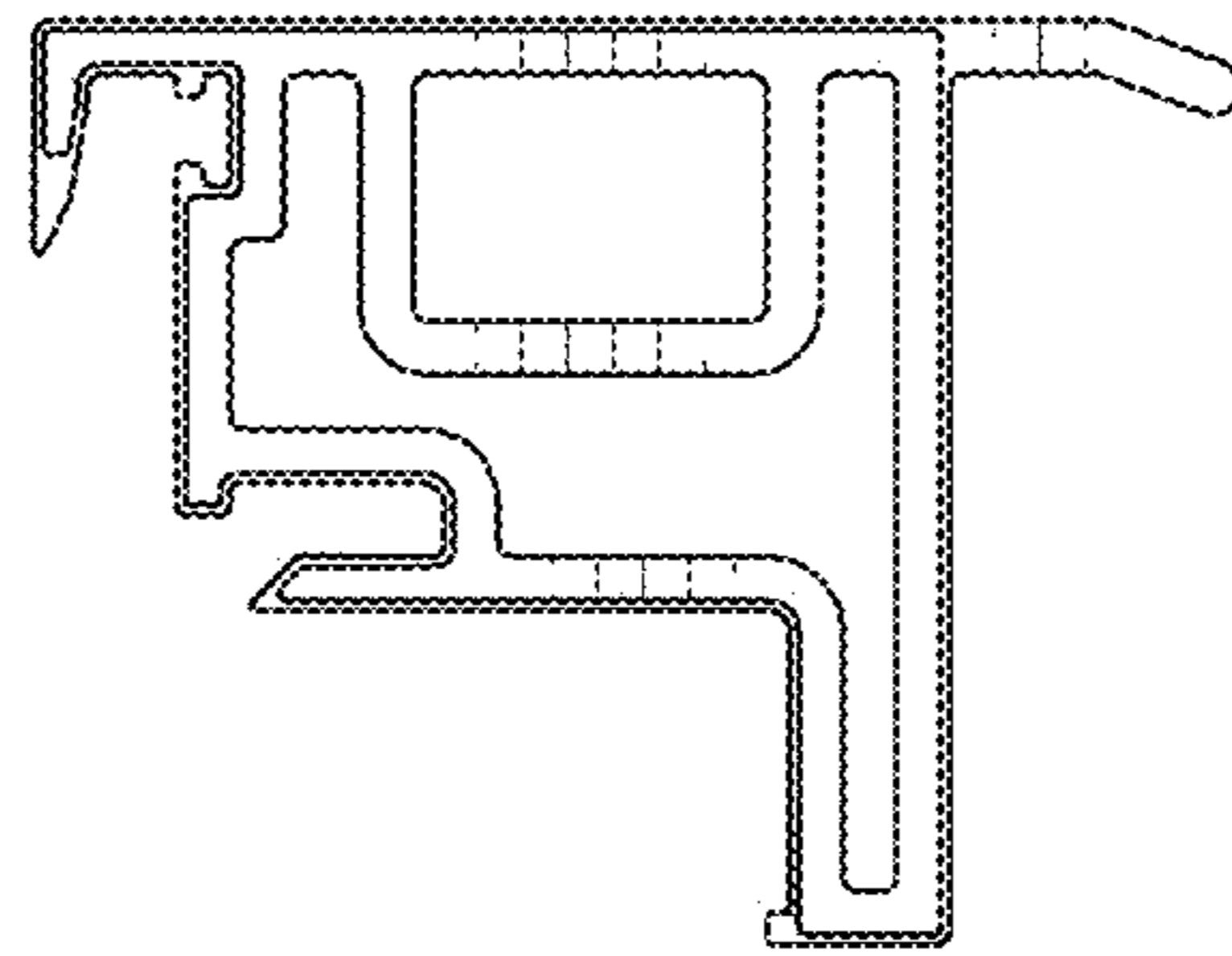

FIG. 5

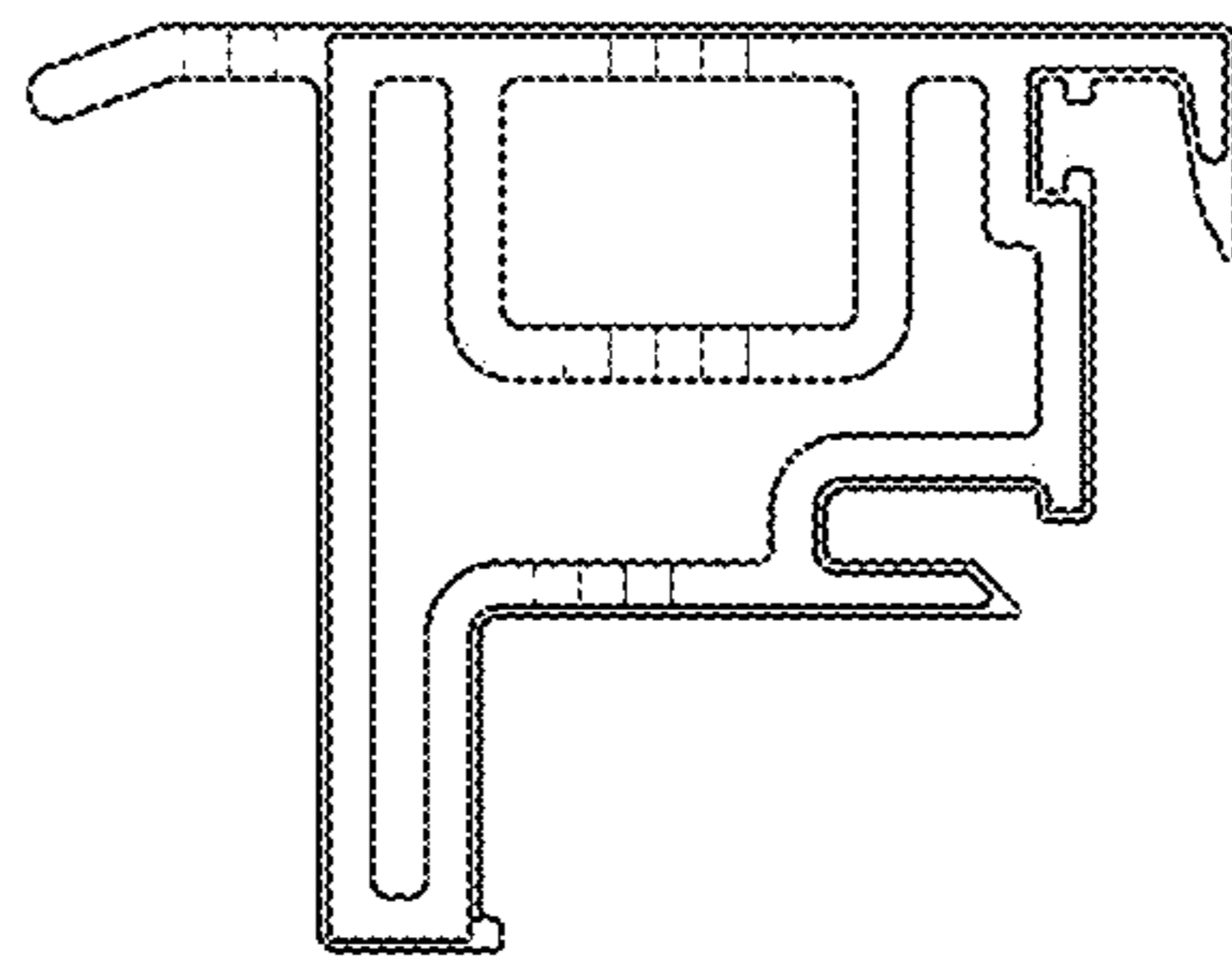

FIG. 6

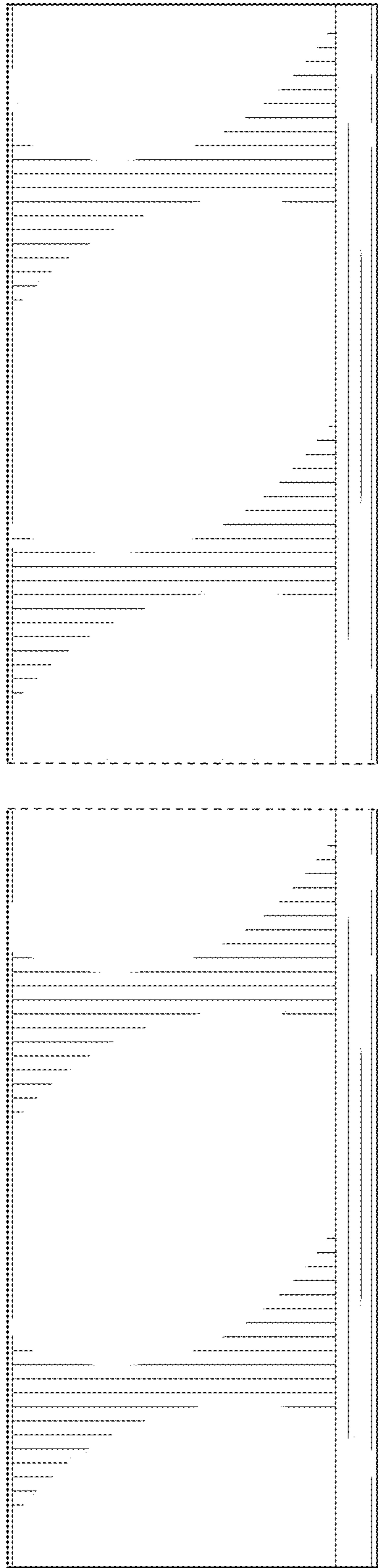

FIG. 7

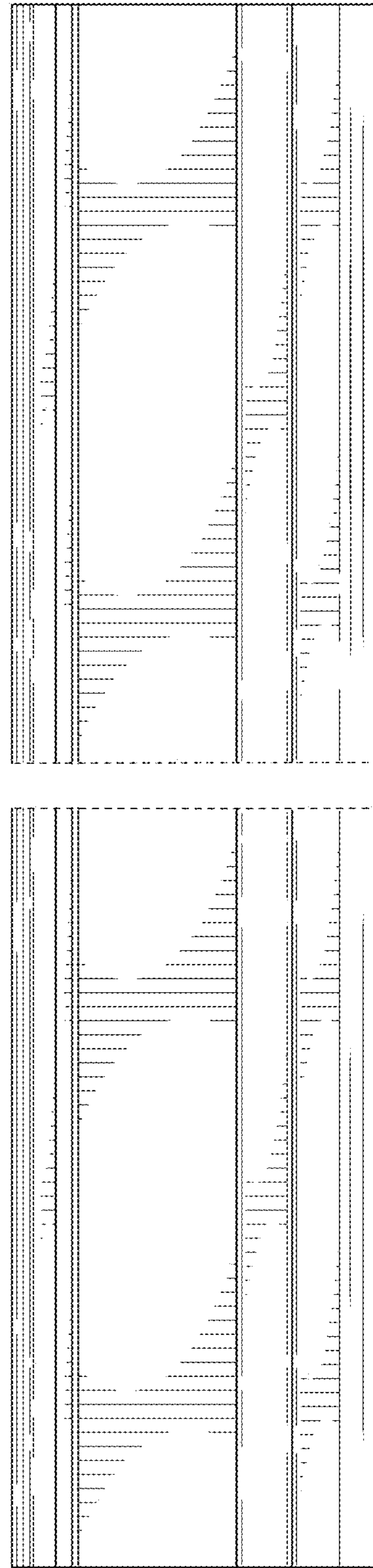

FIG. 8