



US00D918381S

(12) **United States Design Patent** (10) **Patent No.:** **US D918,381 S**  
**Luong et al.** (45) **Date of Patent:** **\*\* May 4, 2021**

(54) **BASE**  
(71) Applicant: **Willo 32 SAS**, Limoges (FR)  
(72) Inventors: **Teddy Luong**, San Francisco, CA (US);  
**Fred Bould**, Menlo Park, CA (US);  
**Kwan Hon Anson Cheung**, San Francisco, CA (US)

(73) Assignee: **Willo 32 SAS**, Limoges (FR)

(\*\*) Term: **15 Years**

(21) Appl. No.: **29/694,517**

(22) Filed: **Jun. 11, 2019**

(51) **LOC (13) Cl.** ..... **24-02**

(52) **U.S. Cl.**  
USPC ..... **D24/111**

(58) **Field of Classification Search**  
USPC ..... D24/107, 108, 111–113, 121, 127, 164,  
D24/177, 188, 185; D4/100–102, 114  
CPC . A61C 17/02; A61C 17/0202; A61C 17/0205;  
A61C 17/024; A61C 17/028  
See application file for complete search history.

(56) **References Cited**

U.S. PATENT DOCUMENTS

D371,242 S *	7/1996	Shimatsu	.....	D4/101
D388,612 S *	1/1998	Stutzer	.....	D24/111
D388,613 S *	1/1998	Stutzer	.....	D24/111
D764,051 S *	8/2016	Wang	.....	D24/111
D797,278 S *	9/2017	Uchida	.....	D24/111
D809,650 S *	2/2018	Kim	.....	D24/111
D822,825 S *	7/2018	Au	.....	D24/111
D832,420 S *	10/2018	Porter	.....	D24/111
D833,000 S *	11/2018	Porter	.....	D24/111
D834,180 S *	11/2018	Porter	.....	D24/111
D858,750 S *	9/2019	Porter	.....	D24/111
D867,579 S *	11/2019	Porter	.....	D24/111

D872,855 S *	1/2020	Porter	.....	D24/111
D888,230 S *	6/2020	Li	.....	D24/111
D893,017 S *	8/2020	Porter	.....	D24/111
10,779,922 B2 *	9/2020	Wagner	.....	A61C 17/028
2018/0168784 A1 *	6/2018	Wagner	.....	A61C 17/0202
2018/0168785 A1 *	6/2018	Wagner	.....	A61C 17/0202
2020/0245753 A1 *	8/2020	Jeung	.....	A46B 11/06

FOREIGN PATENT DOCUMENTS

EM 006954665-0001 \* 10/2019

\* cited by examiner

*Primary Examiner* — Lilyana Bekic

(74) *Attorney, Agent, or Firm* — Daylight Law, P.C.

(57) **CLAIM**

The ornamental design for a base, as shown and described.

**DESCRIPTION**

FIG. 1 is a top-front-right perspective view of a base showing our new design;  
FIG. 2 is a top-right-back perspective view thereof;  
FIG. 3 is a bottom-left perspective view thereof;  
FIG. 4 is a front view thereof;  
FIG. 5 is a back view thereof;  
FIG. 6 is a right-side view thereof;  
FIG. 7 is a left-side view thereof;  
FIG. 8 is a top view thereof;  
FIG. 9 is a bottom view thereof;  
FIG. 10 is a top-right-back perspective thereof with a handle removed; and,  
FIG. 11 is a right-side view thereof with the handle removed.  
The broken lines in FIGS. 1-9 depict portions of the base and environmental structures in the form of the handle and tubing that form no part of the claimed design.  
The broken lines in FIGS. 10-11 depict portions of the base that form no part of the claimed design.

**1 Claim, 11 Drawing Sheets**

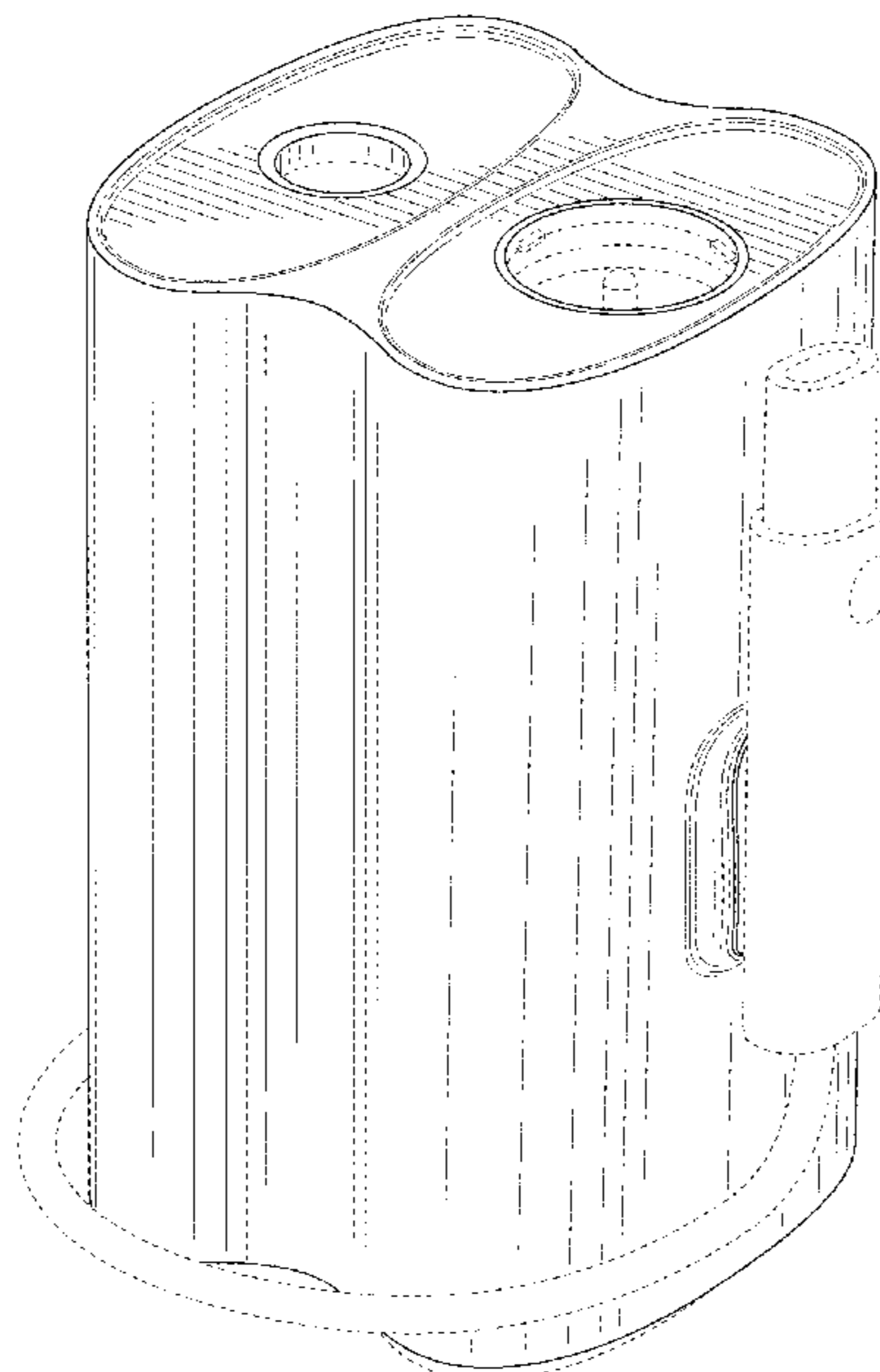

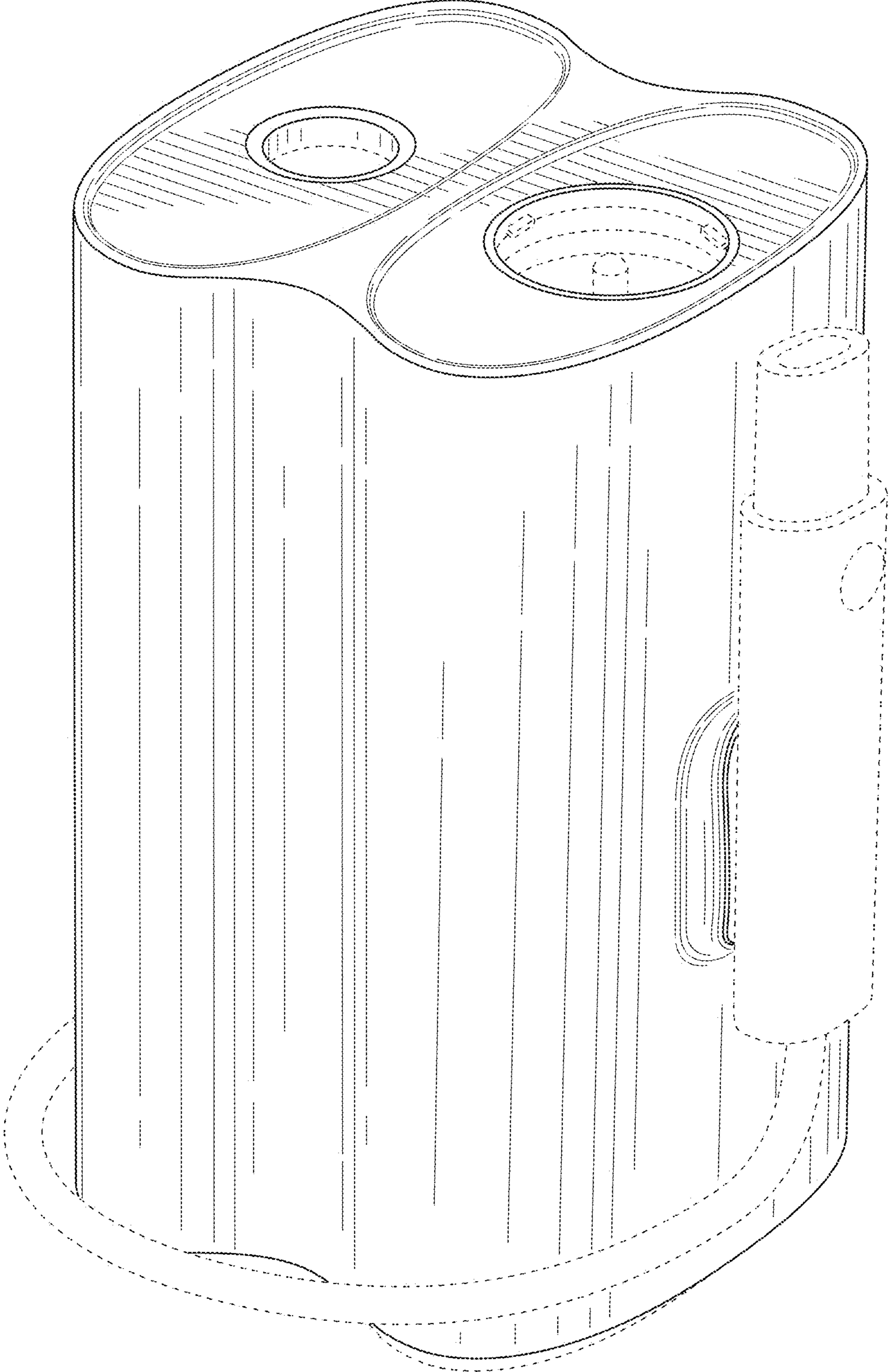

FIG. 1

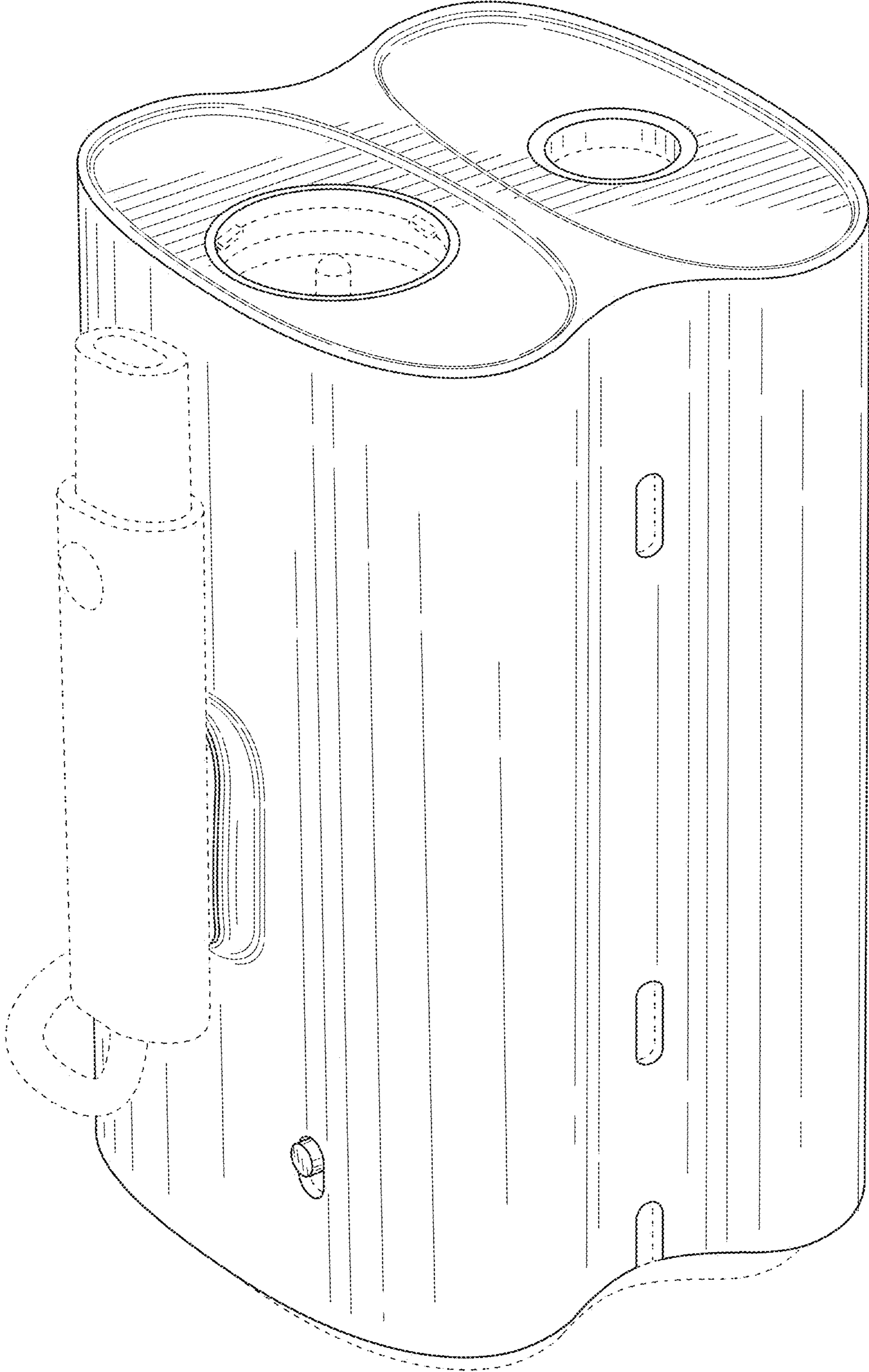

FIG. 2

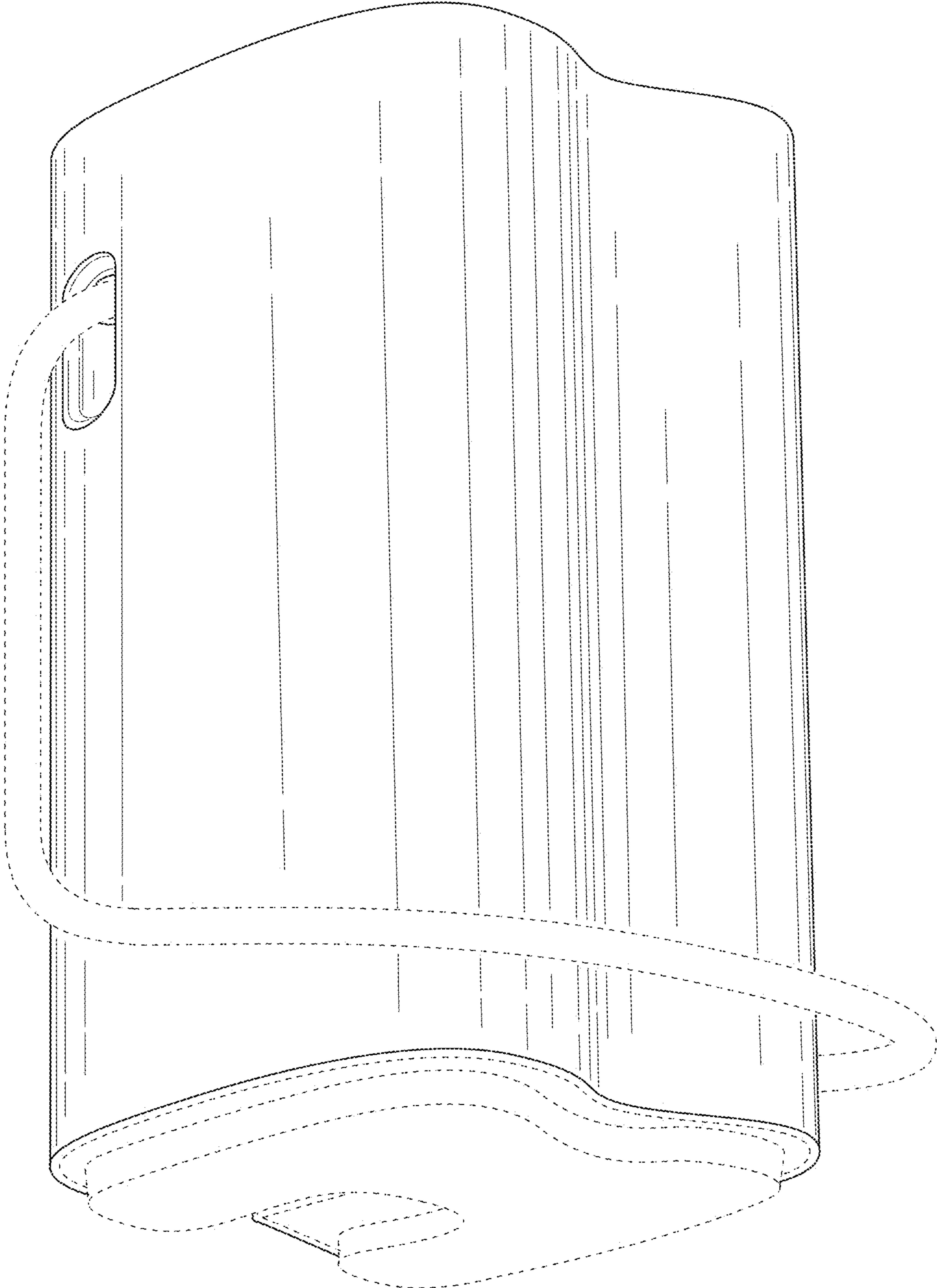

FIG. 3

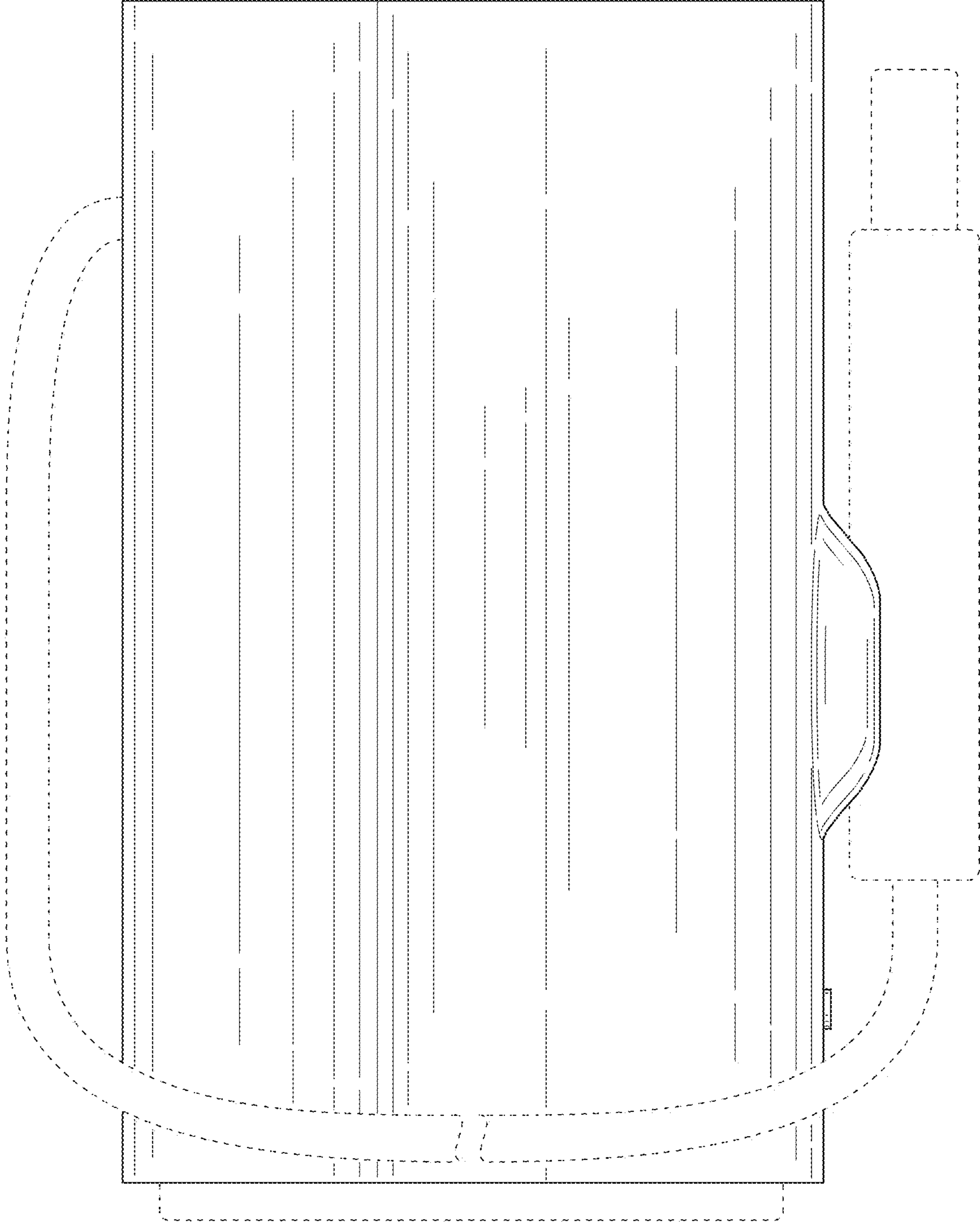

FIG. 4

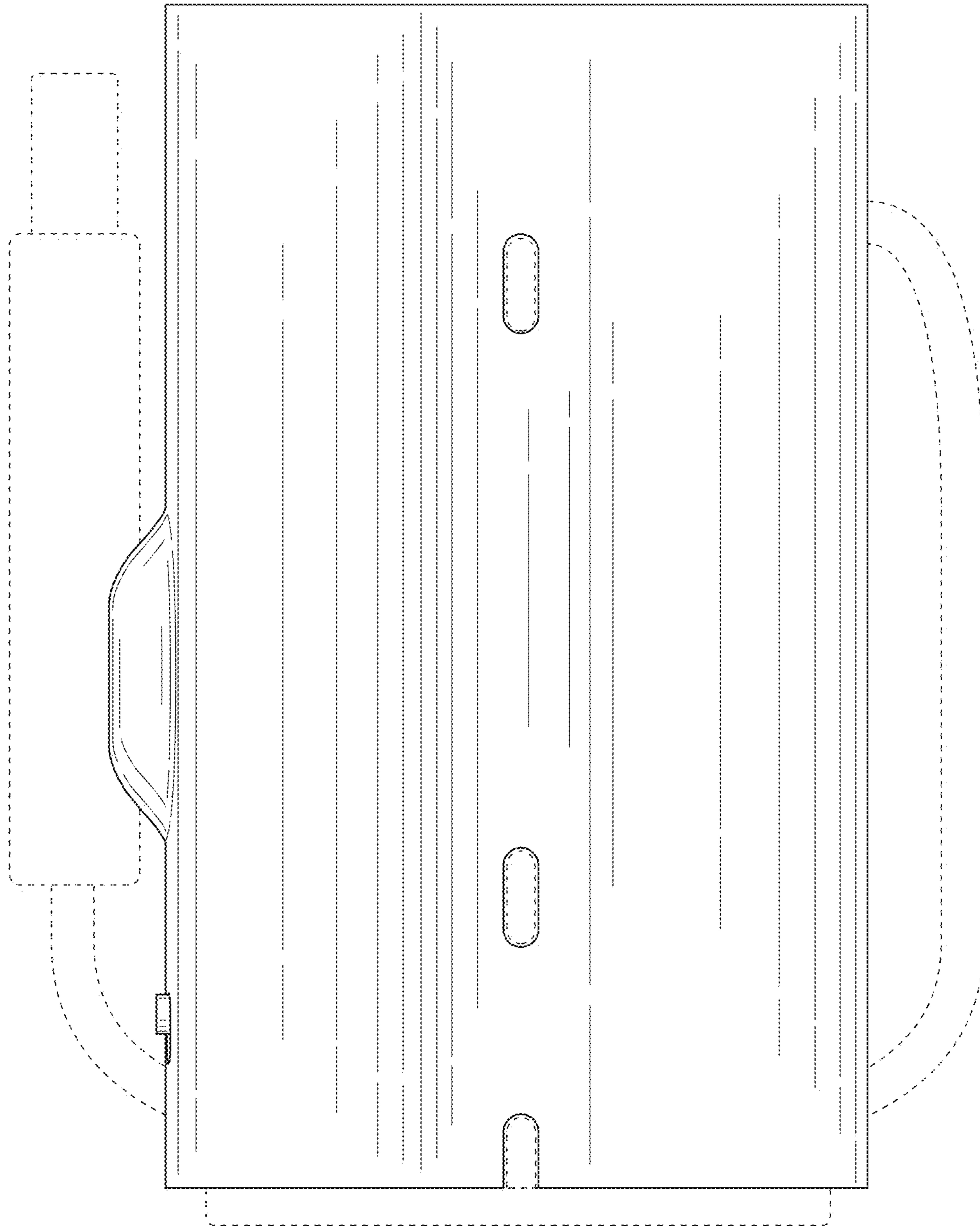

FIG. 5

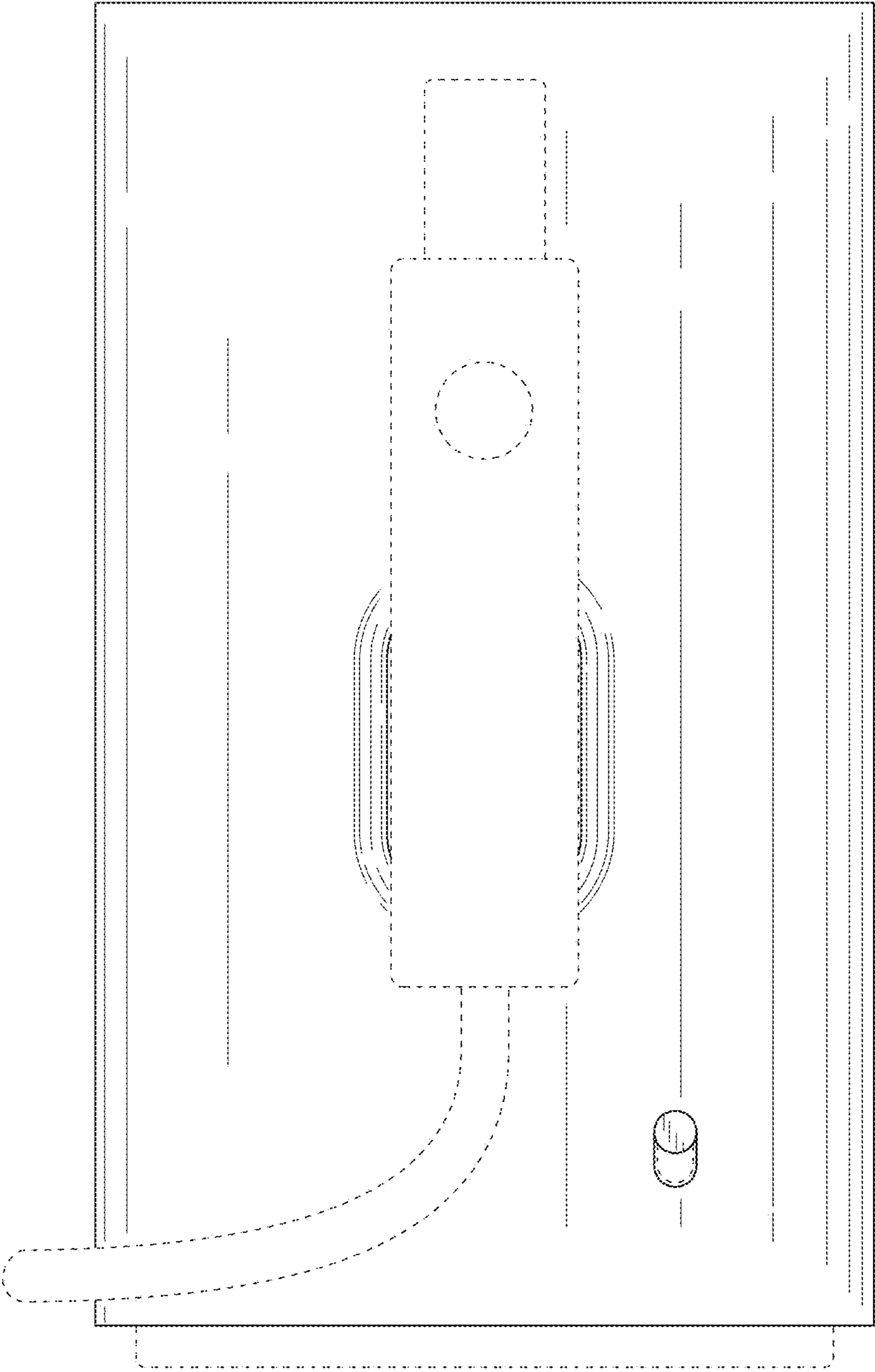

FIG. 6

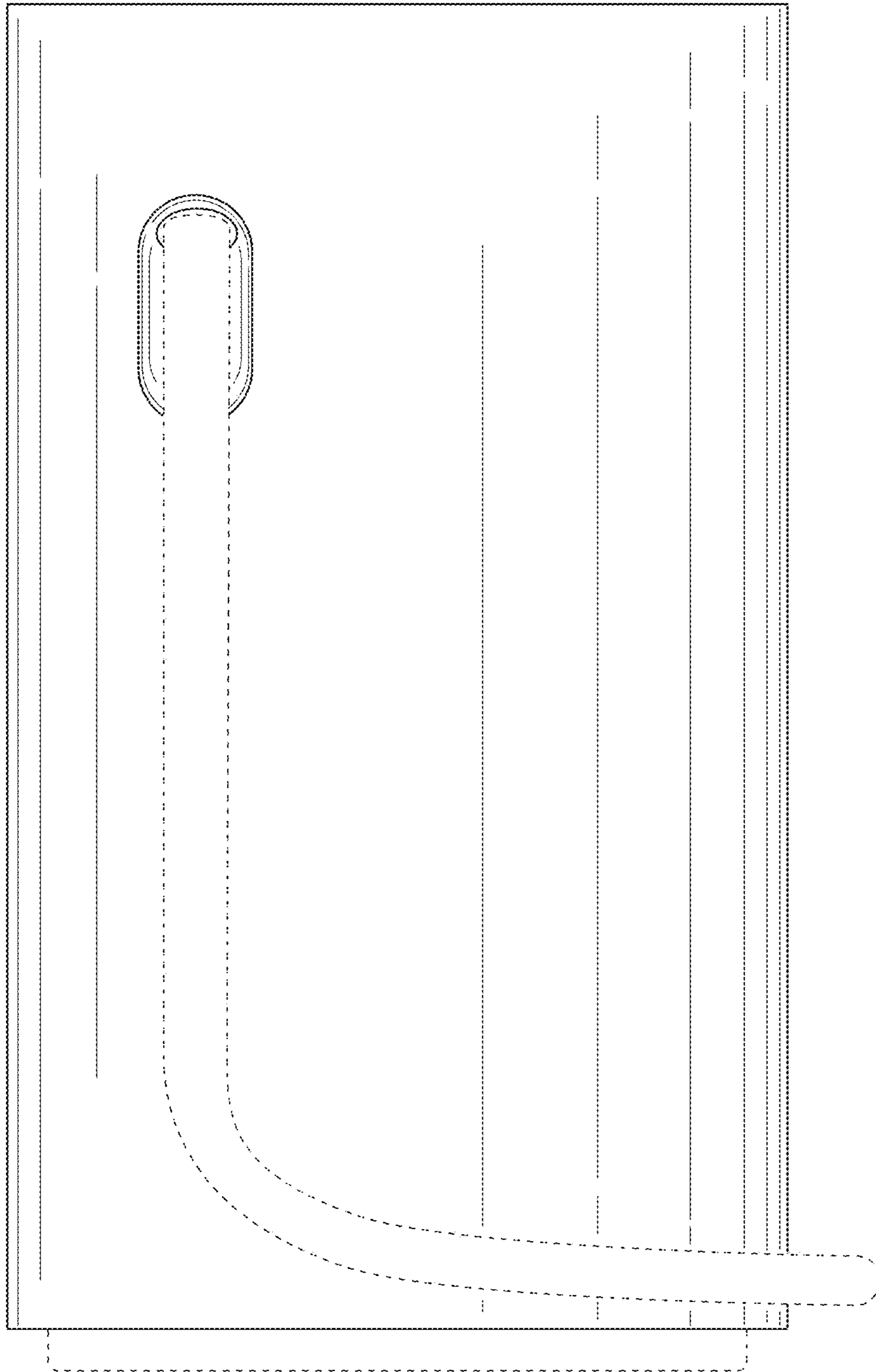

FIG. 7



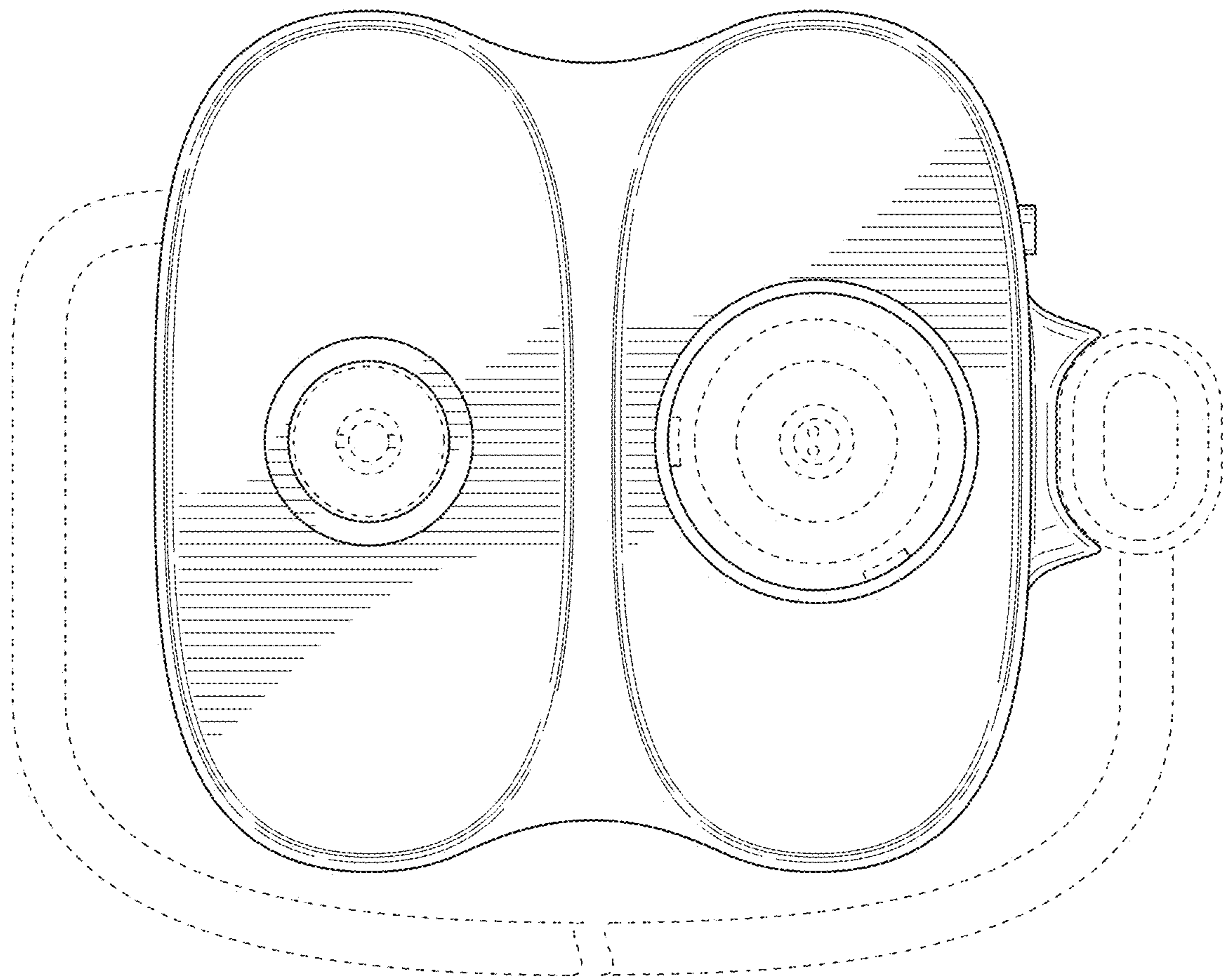

FIG. 8

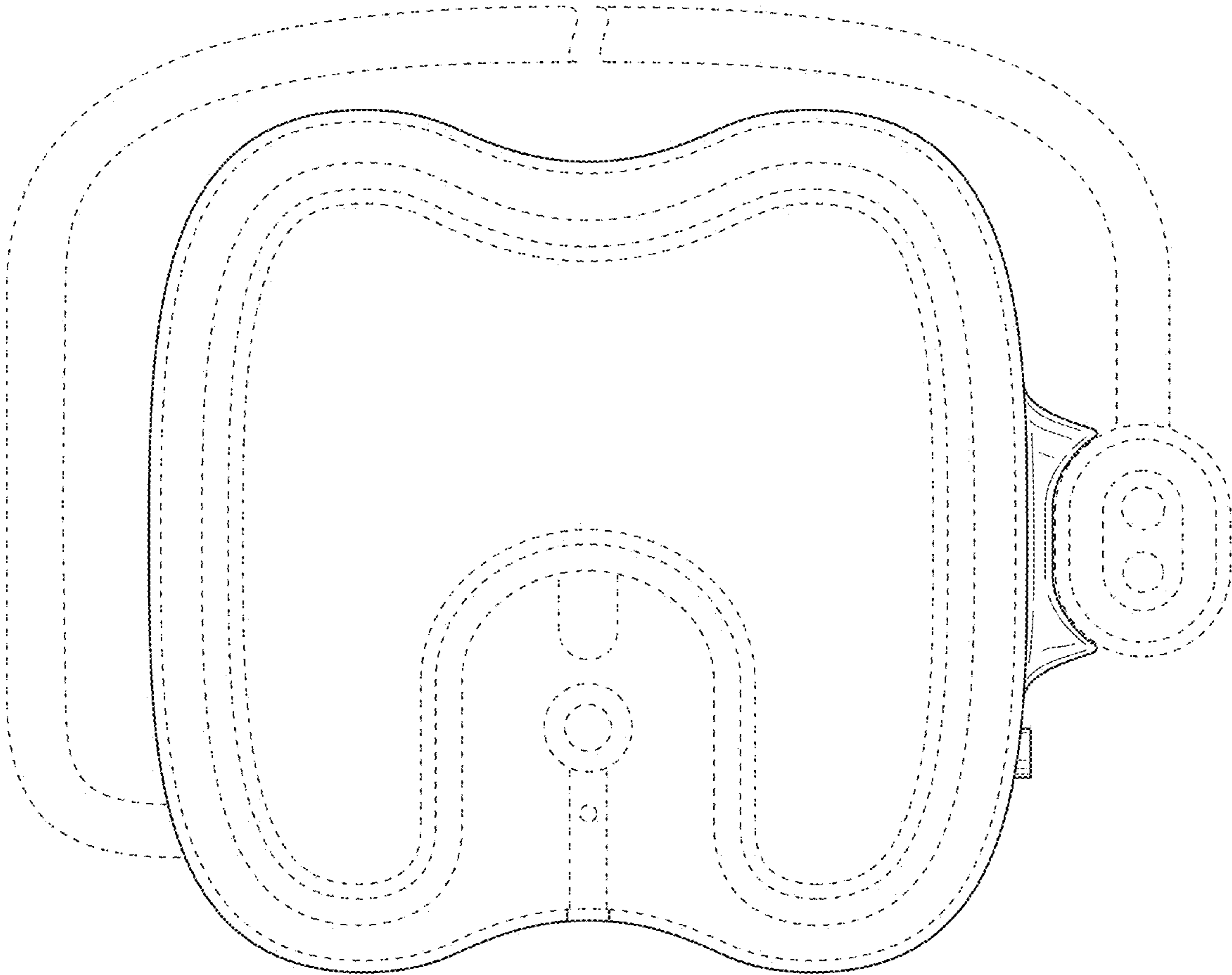

FIG. 9

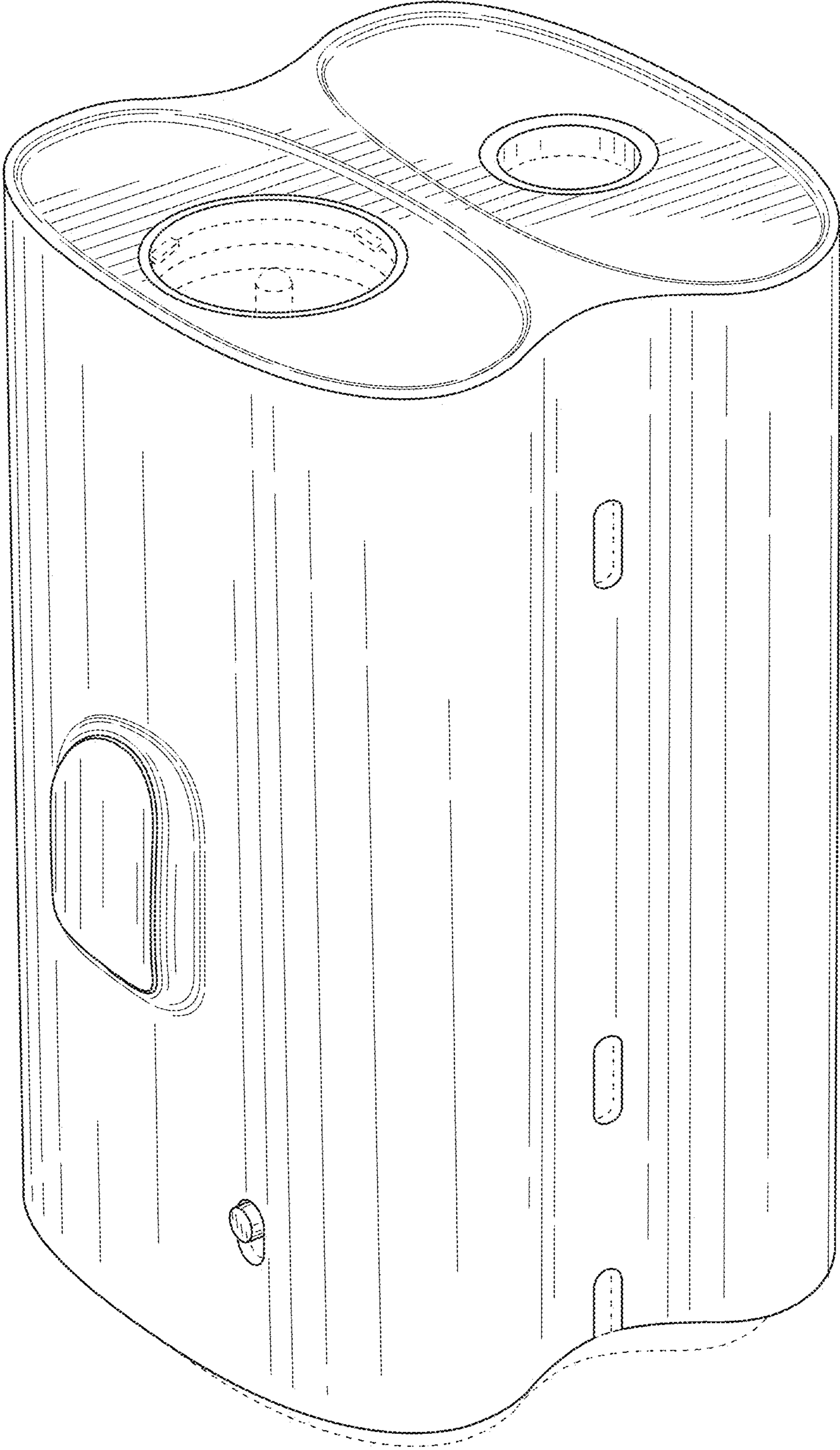

FIG. 10

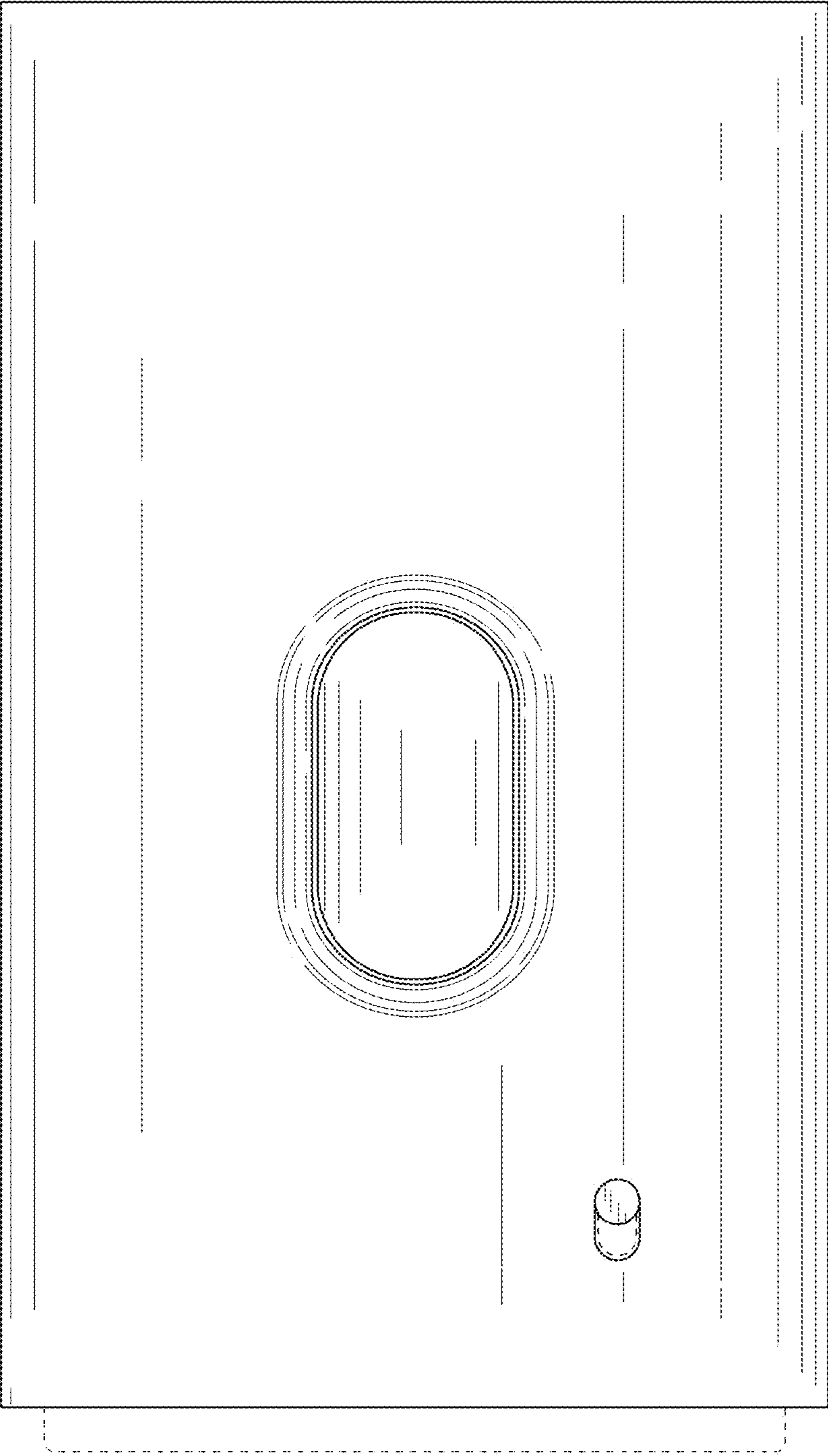

FIG. 11