



US00D918310S

(12) **United States Design Patent**
Wu et al.

(10) **Patent No.:** **US D918,310 S**

(45) **Date of Patent:** **** May 4, 2021**

(54) **CONSTRUCTION SET BLOCK**

(71) Applicant: **UBTECH Robotics Corp**, Shenzhen (CN)

(72) Inventors: **Yumiao Wu**, Shenzhen (CN); **Lefeng Liu**, Shenzhen (CN); **Qiujie Lin**, Shenzhen (CN); **Xinshui Huang**, Shenzhen (CN); **Youjun Xiong**, Shenzhen (CN)

(73) Assignee: **UBTECH ROBOTICS CORP**, Shenzhen (CN)

(**) Term: **15 Years**

(21) Appl. No.: **29/687,309**

(22) Filed: **Apr. 12, 2019**

(51) **LOC (13) Cl.** **21-01**

(52) **U.S. Cl.**
USPC **D21/503**

(58) **Field of Classification Search**

USPC D21/478, 479, 484, 485–505
CPC A63H 33/00; A63H 33/04; A63H 33/06;
A63H 33/08; A63H 33/10; A63H 33/12;
A63H 33/14; A63F 9/08; A63F 9/12;
G09B 1/36

See application file for complete search history.

(56) **References Cited**

U.S. PATENT DOCUMENTS

4,205,482 A * 6/1980 Christiansen A63H 3/16
446/118
D290,475 S * 6/1987 Knudsen D21/503

D333,852 S * 3/1993 Olsen D21/500
D343,429 S * 1/1994 Sorensen D21/502
D344,769 S * 3/1994 Poulsen D21/502
D363,512 S * 10/1995 Bluff D21/503
D364,198 S * 11/1995 Bluff D21/502
D419,616 S * 1/2000 Toft D21/493
D516,135 S * 2/2006 Kim D21/503
D755,902 S * 5/2016 Chen D21/484
D786,984 S * 5/2017 Pouliot D21/492

* cited by examiner

Primary Examiner — Cynthia M. Chin

(57) **CLAIM**

The ornamental design for a construction set block, as shown and described.

DESCRIPTION

FIG. 1 is a first perspective view of a construction set block showing our new design;
FIG. 2 is a second perspective view of a construction set block showing our new design;
FIG. 3 is a front elevational view thereof;
FIG. 4 is a rear elevational view thereof;
FIG. 5 is a left side elevational view thereof;
FIG. 6 is a right side elevational view thereof;
FIG. 7 is a top plan view thereof; and,
FIG. 8 is a bottom plan view thereof.
The broken lines in the Figures are for the purpose of illustrating portions of the article that form no part of the claimed design.

1 Claim, 8 Drawing Sheets

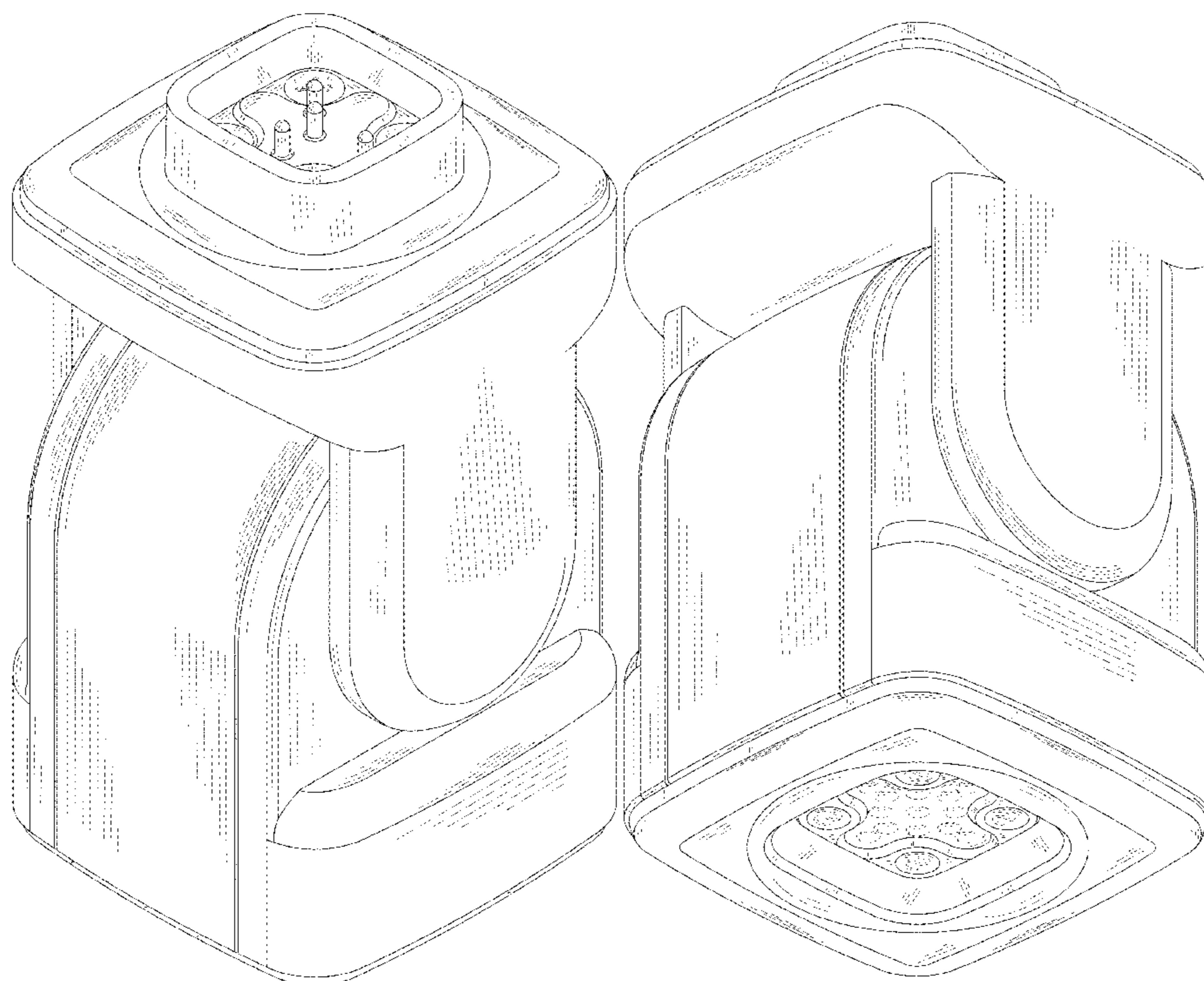

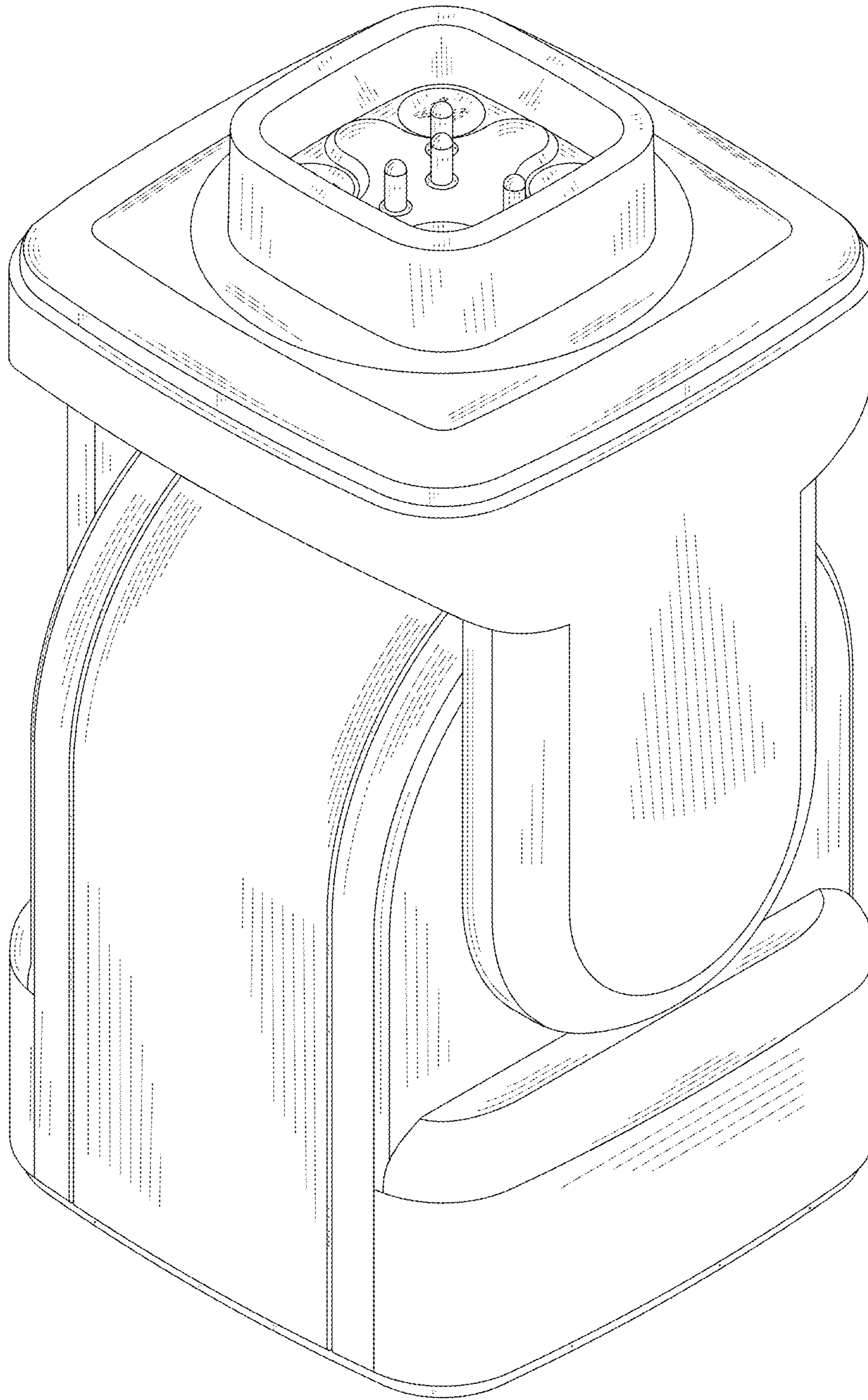

FIG. 1

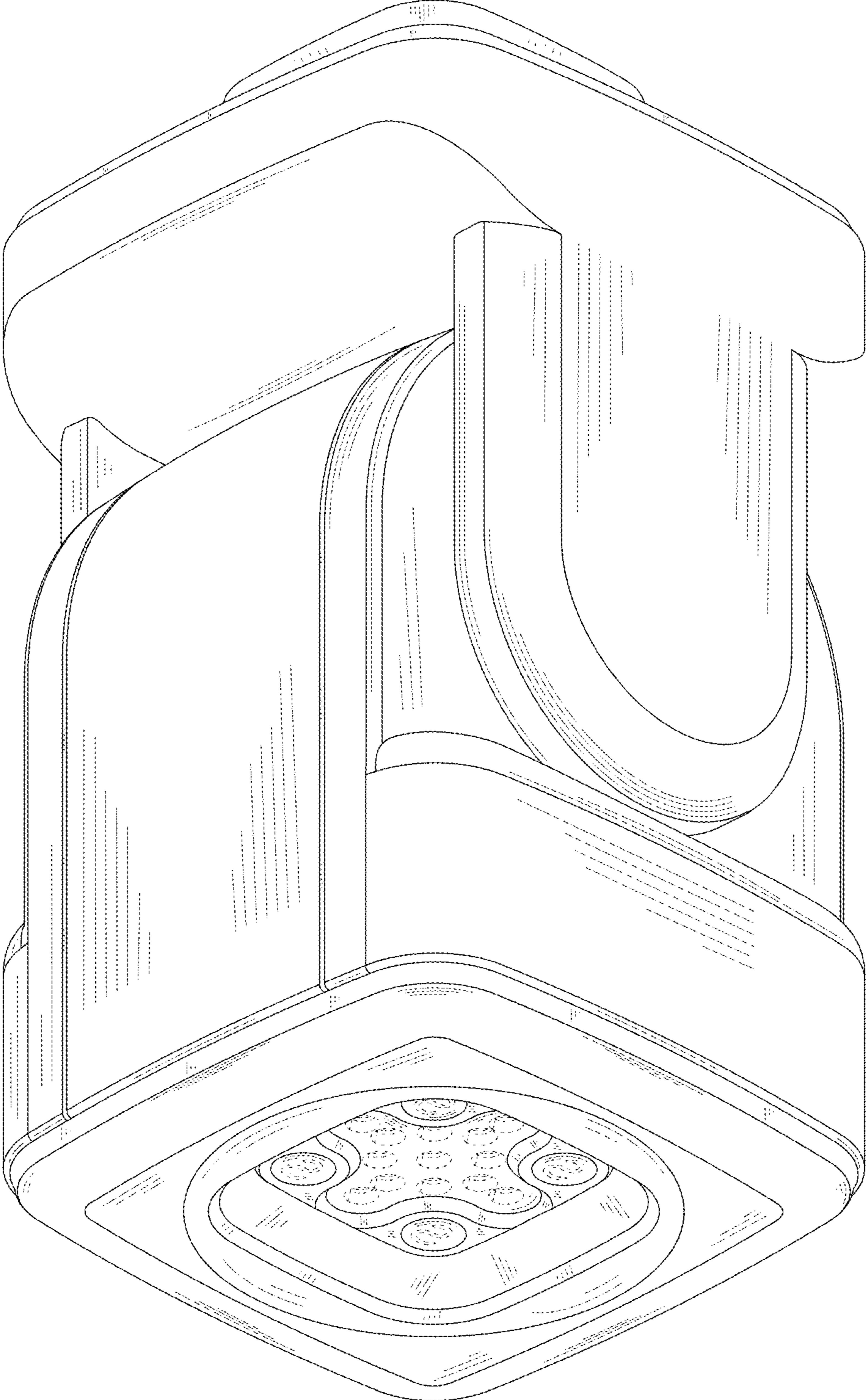

FIG. 2

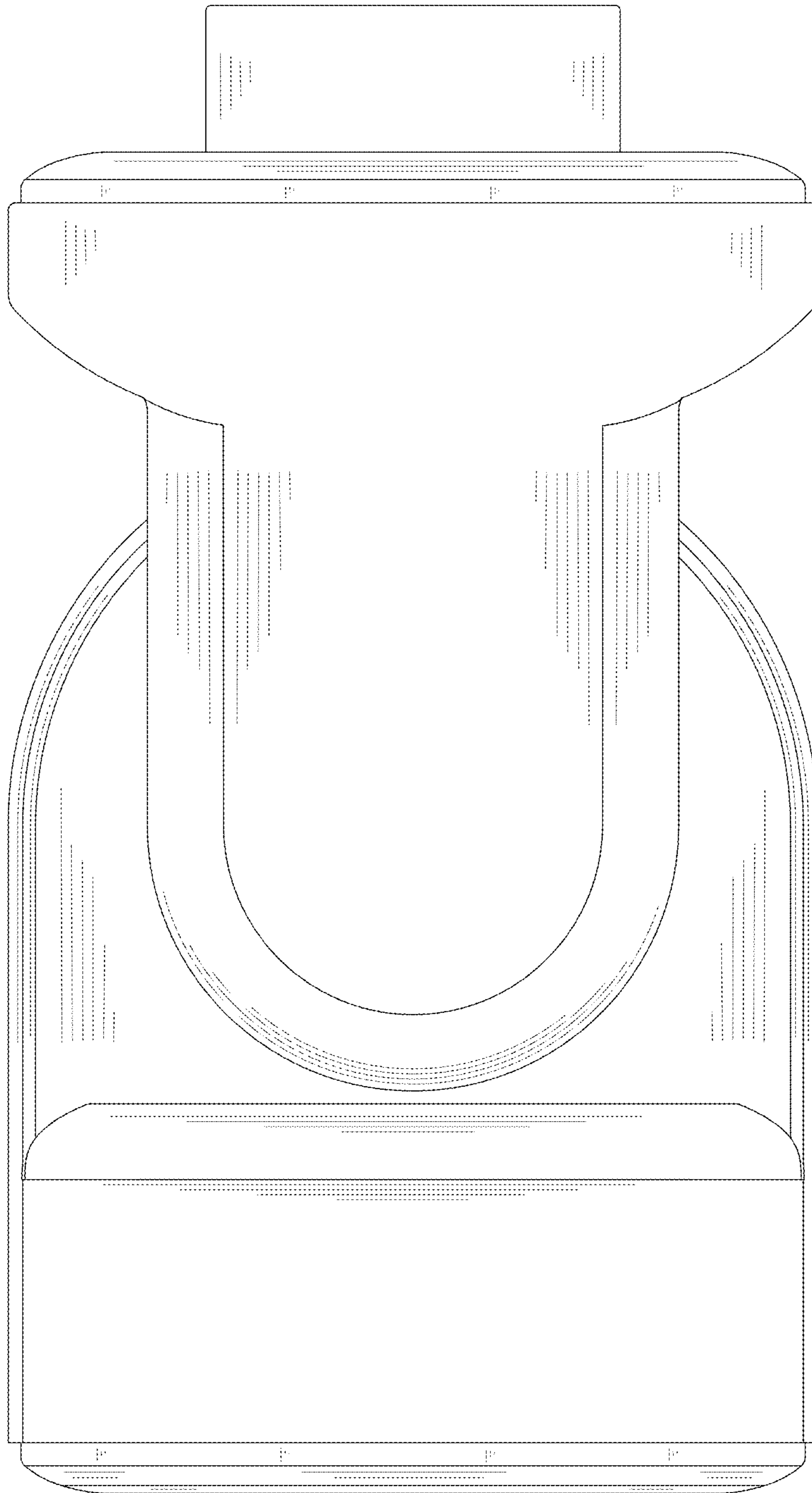

FIG. 3

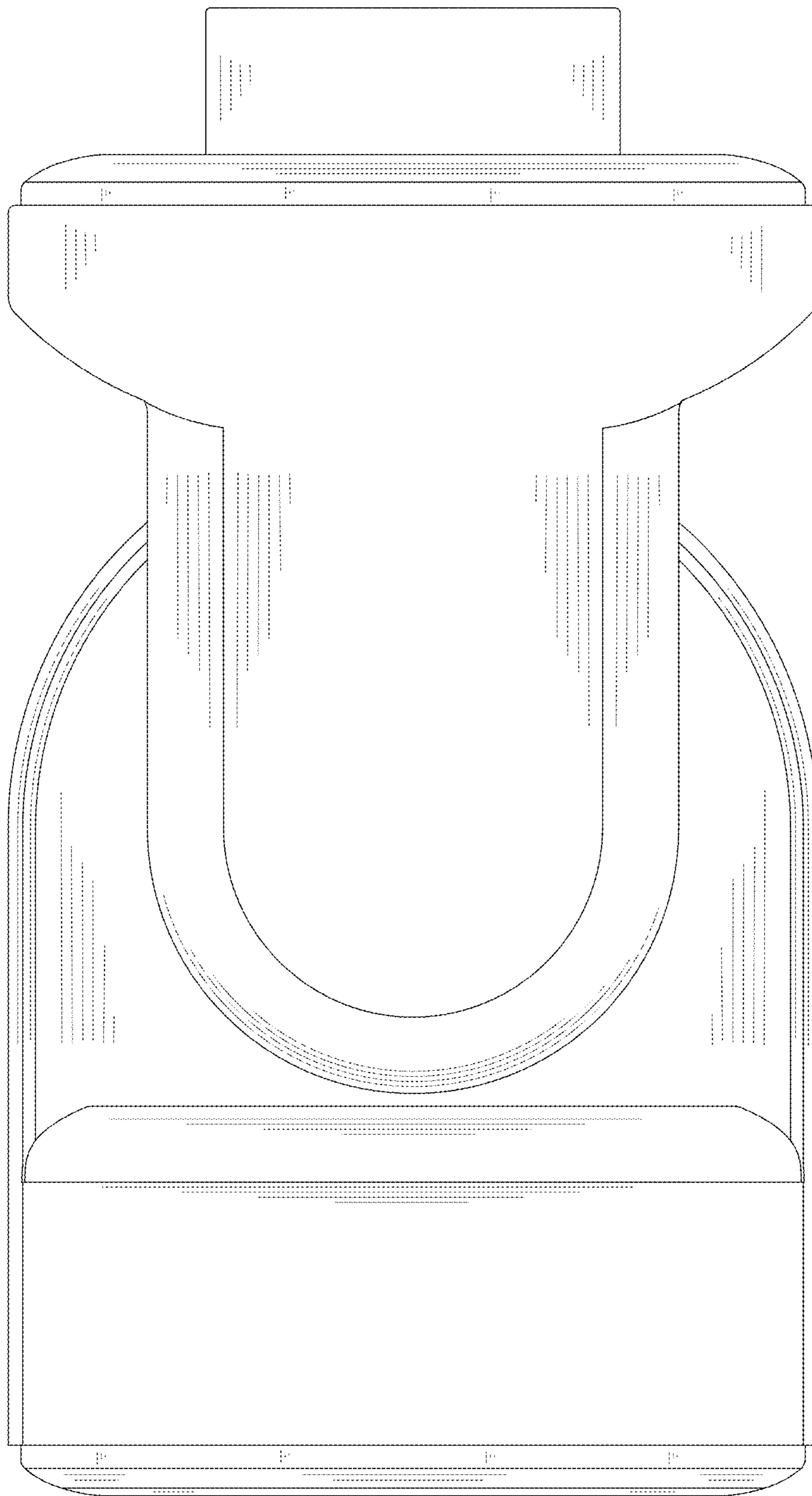

FIG. 4

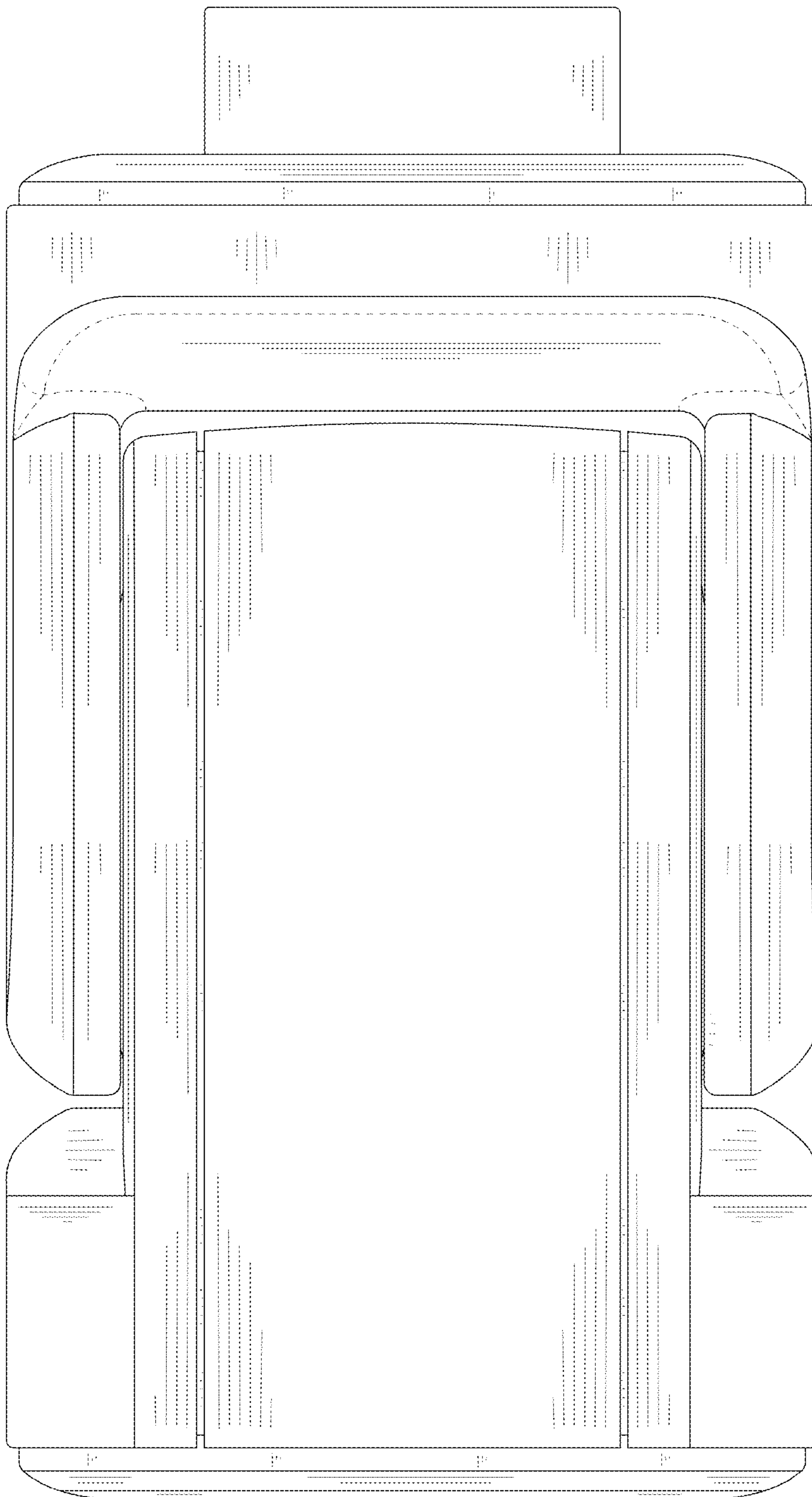

FIG. 5

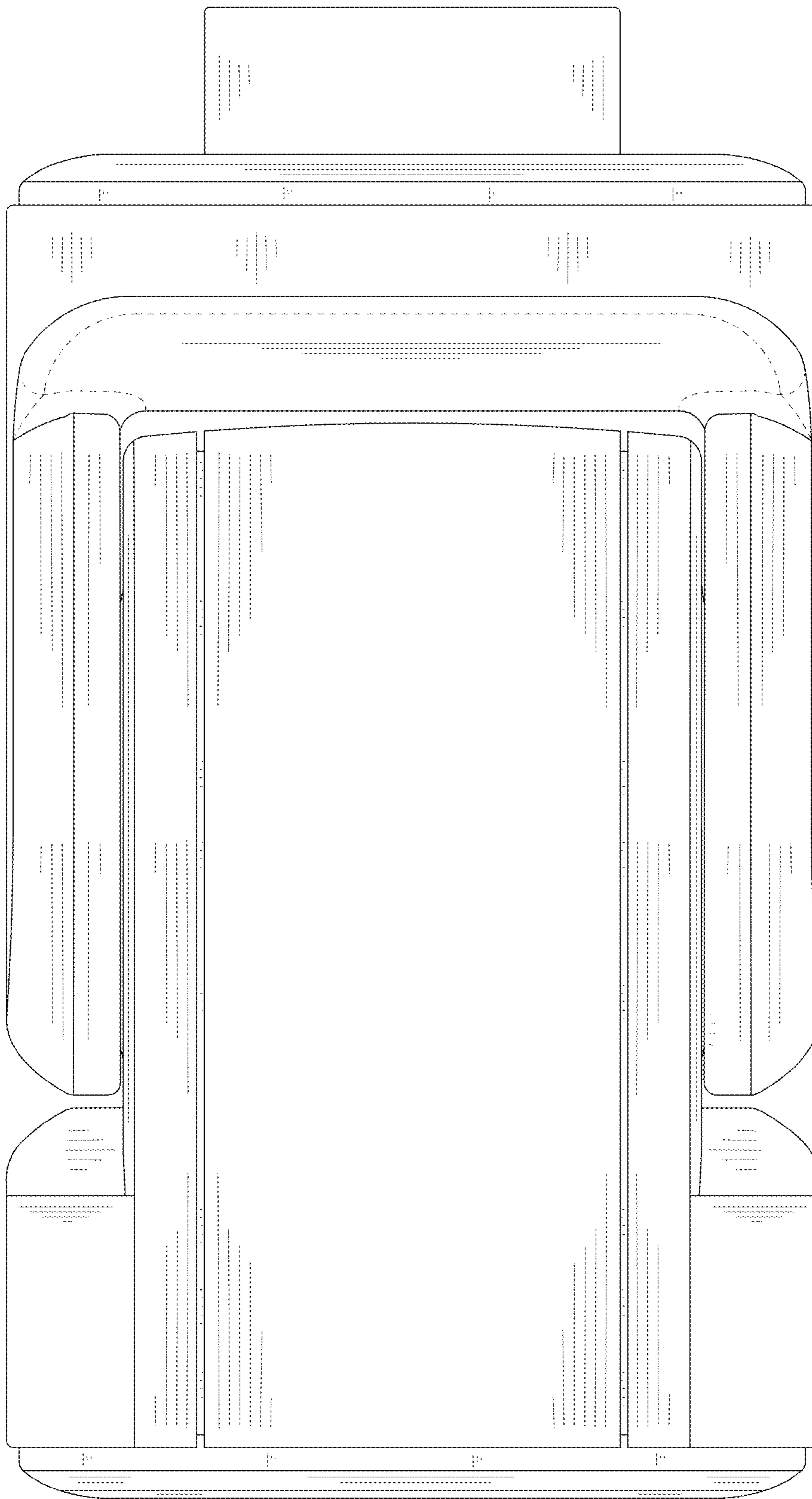

FIG. 6

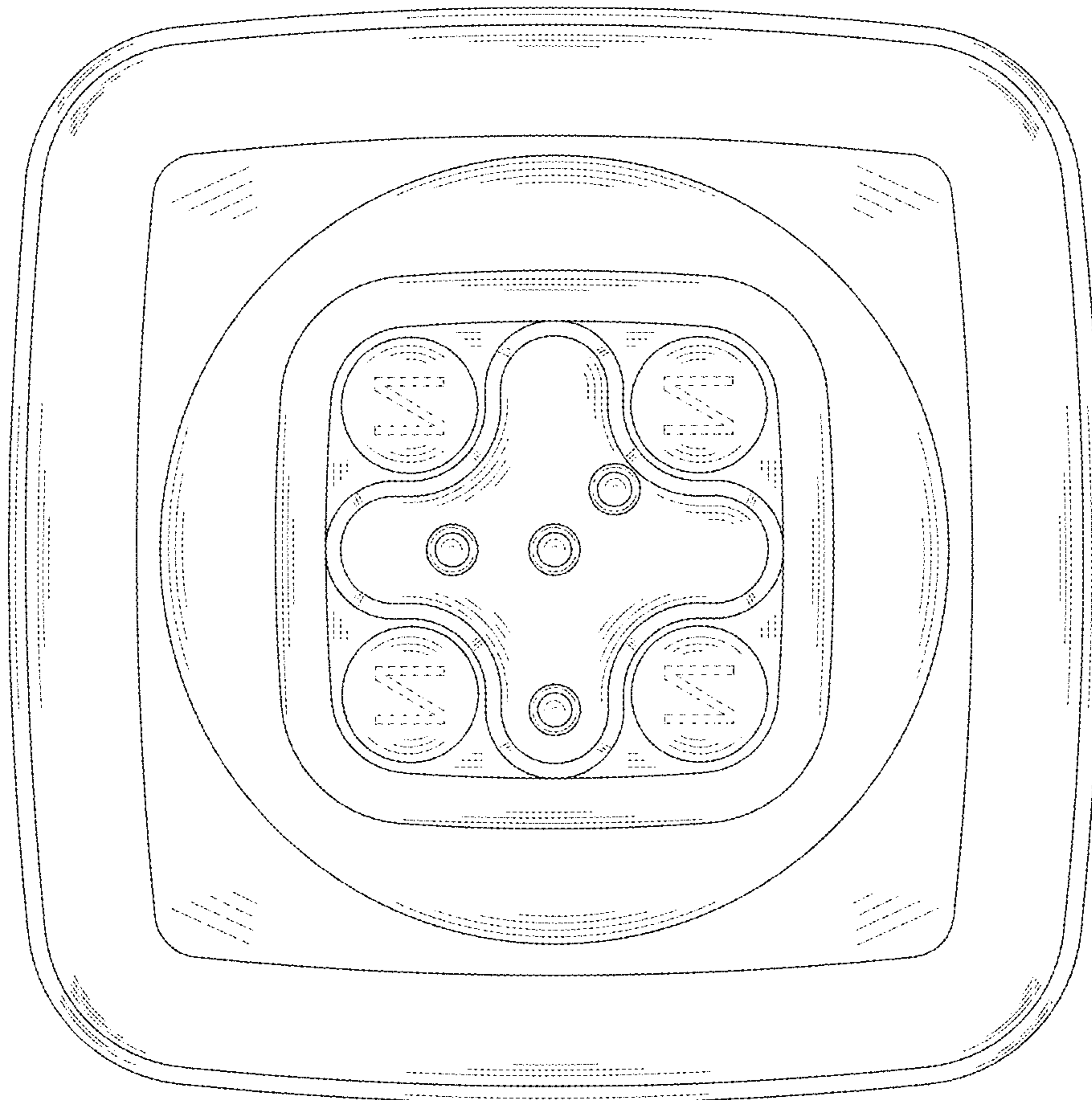

FIG. 7

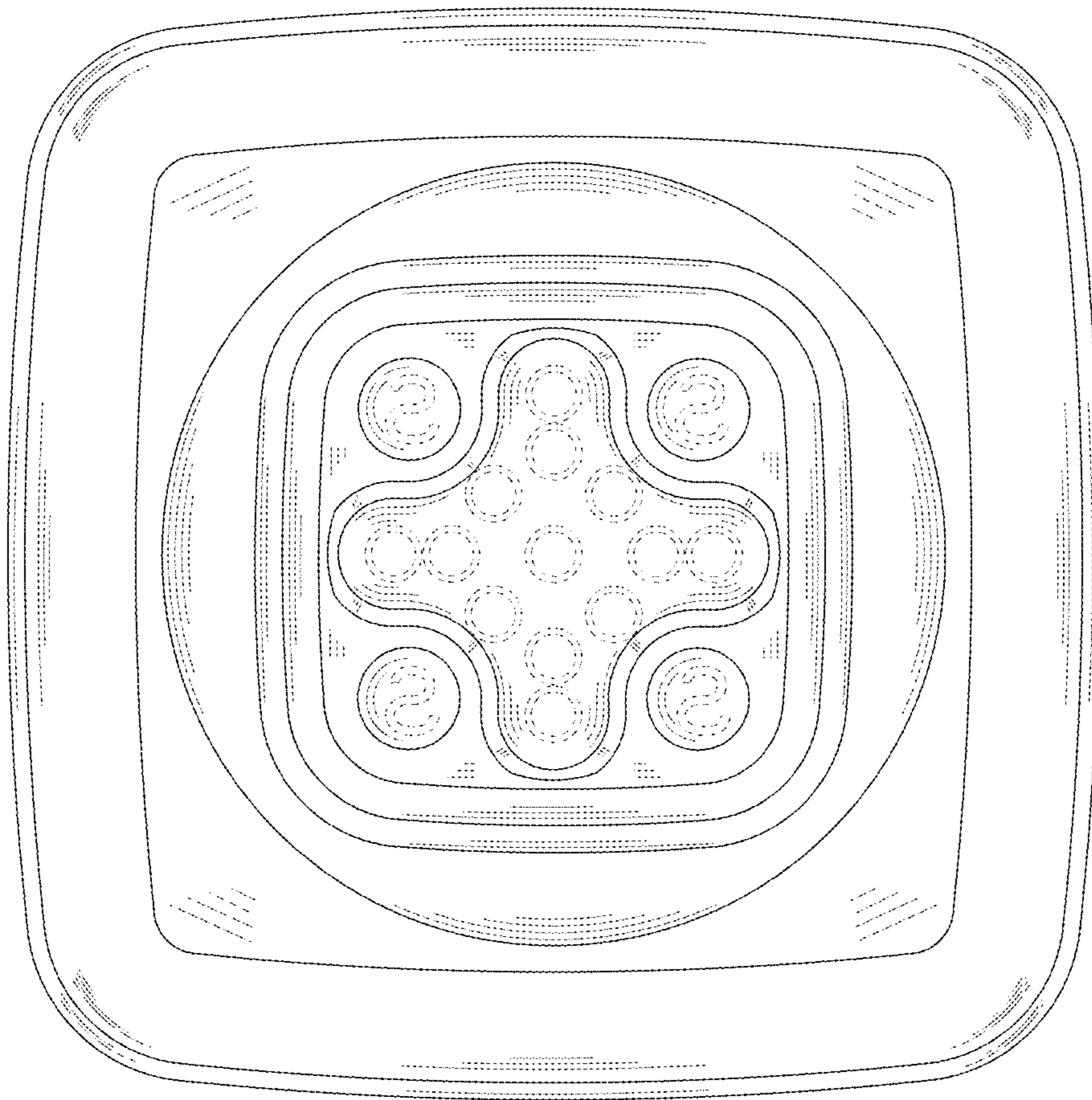

FIG. 8