



US00D918302S

(12) **United States Design Patent** (10) **Patent No.:** **US D918,302 S**
Michelsson (45) **Date of Patent:** **** May 4, 2021**

(54) **BOARD GAME**

(71) Applicant: **Oy Martinex Ab**, Raisio (FI)

(72) Inventor: **Aleksi Michelsson**, Turku (FI)

(73) Assignee: **OY MARTINEX AB**

(**) Term: **15 Years**

(21) Appl. No.: **29/757,255**

(22) Filed: **Nov. 4, 2020**

Related U.S. Application Data

(62) Division of application No. 29/656,843, filed on Jul. 17, 2018.

(30) **Foreign Application Priority Data**

May 7, 2018 (EM) 005260171-0001
May 7, 2018 (EM) 005260171-0002
May 7, 2018 (EM) 005260171-0003
May 7, 2018 (EM) 005260171-0004

(51) **LOC (13) Cl.** **21-01**

(52) **U.S. Cl.**
USPC **D21/342**

(58) **Field of Classification Search**
USPC D21/300, 324, 333-346, 365, 369, 385,
D21/392-397, 148 R, 309, 459, 460;
273/342-346, 335, 236, 237, 238, 242,
273/244.2, 248-263, 274, 275, 277-291,
273/292; D10/46.1, 46; 235/90,
235/1 B-1 D; 463/13, 1, 46, 47; 16/225;
116/222-225, 325, 326
CPC A63F 1/00; A63F 1/06; A63F 1/062; A63F
1/067; A63F 1/18; A63F 3/0023; A63F
3/00574; A63F 3/00006; A63F 3/00643;
A63F 3/00082; A63F 3/00097; A63F
3/00173; A63F 3/00157; A63F 3/00261;
A63F 2003/00233; A63F 2003/00946;

(Continued)

(56) **References Cited**

U.S. PATENT DOCUMENTS

2,416,959 A * 3/1947 Segal A63F 9/08
434/259
2,499,557 A * 3/1950 Anderson A63F 7/04
273/113

(Continued)

Primary Examiner — Susan Moon Lee

(74) *Attorney, Agent, or Firm* — Ware, Fressola, Maguire
& Barber LLP

(57) **CLAIM**

The ornamental design for a board game, as shown and described.

DESCRIPTION

FIG. 1 is an exploded perspective view of the game board showing my new design, the insertable game pieces removed, for clarity of illustration; FIG. 2 is a top view thereof. FIG. 3 is a bottom thereof. FIG. 4 is a left side view thereof. FIG. 5 is a right side view thereof. FIG. 6 is a front view thereof. FIG. 7 is a back view thereof. FIG. 8 is a perspective view of the board game thereof with game pieces separated from the board game. FIG. 9 is a top view thereof with game pieces inserted. FIG. 10 is a left side view thereof with game pieces separated from the board game. FIG. 11 is a right side view thereof with game pieces separated from the board game. FIG. 12 is a front view thereof with game pieces inserted, the back view being a mirror image thereof; and, FIG. 13 is a front view thereof with game pieces separated from the board game, the back view being a mirror image thereof.

1 Claim, 13 Drawing Sheets

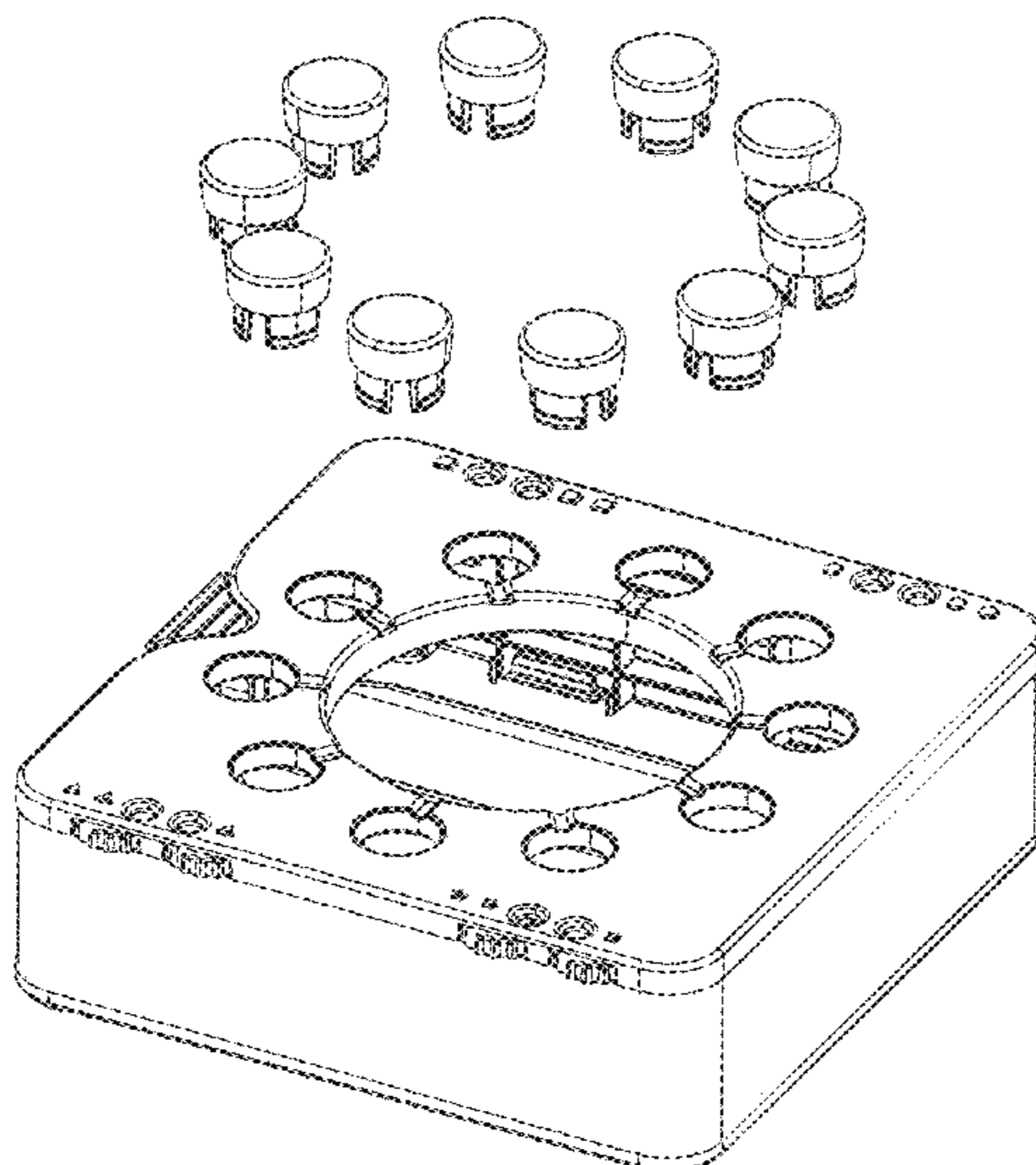

(58) **Field of Classification Search**
 CPC A63F 2003/00943; A63F 2003/0034; A63F
 2003/00583; A63F 2003/00182; A63F
 2003/0022; A63F 2003/00255; A63F
 2003/00457; A63F 2250/20; A63F
 9/0093; A63F 9/24; A63F 11/0051; A63F
 2011/0055; A63F 2009/245134
 See application file for complete search history.

(56) **References Cited**

U.S. PATENT DOCUMENTS

2,963,796 A * 12/1960 Zalkind A63F 9/08
 434/259
 3,362,103 A * 1/1968 Neumann A63H 33/3066
 434/345
 3,486,245 A * 12/1969 Nelson G09B 19/025
 434/200
 3,488,052 A * 1/1970 Weisbecker A63F 7/0076
 273/459
 3,510,964 A * 5/1970 Dahners G09B 19/0023
 434/98
 3,601,401 A * 8/1971 Beck A63F 3/00028
 273/244.1
 3,710,455 A * 1/1973 Liversidge A63F 9/00
 434/259
 3,760,511 A * 9/1973 Matsumoto A63F 9/00
 434/259
 3,762,714 A * 10/1973 Wilson A63F 7/0076
 273/248
 3,961,794 A * 6/1976 Goldfarb A63F 3/0478
 273/273
 D245,276 S * 8/1977 Jenkins D21/470
 D245,277 S * 8/1977 Jenkins D21/470
 4,118,026 A * 10/1978 Todokoro A63B 65/12
 273/412
 4,214,750 A * 7/1980 Shimizu A63F 9/34
 273/140
 4,257,601 A * 3/1981 Kurita A63F 9/0098
 273/115
 4,286,952 A * 9/1981 Roche G09B 1/10
 273/156

4,298,200 A * 11/1981 Kanbar A63F 9/0669
 273/148 A
 4,310,156 A * 1/1982 Kulesza A63F 9/06
 273/445
 4,359,224 A * 11/1982 Nottingham A63F 7/045
 273/115
 4,385,762 A * 5/1983 Schwartz A63F 9/183
 273/237
 4,398,892 A * 8/1983 Solomon A63F 9/24
 434/259
 D270,459 S * 9/1983 Pino D21/324
 4,422,644 A * 12/1983 Holahan A63F 3/00006
 273/249
 D275,020 S * 8/1984 Charves 273/284
 4,524,967 A * 6/1985 Hanson A63F 9/30
 273/273
 4,609,356 A * 9/1986 Gilden A63F 9/0666
 434/259
 D286,798 S * 11/1986 Krober D21/478
 4,763,898 A * 8/1988 Hemmann A63F 9/00
 273/153 R
 5,201,524 A * 4/1993 Csanady A63F 7/0076
 273/248
 5,752,704 A * 5/1998 Todokoro A63F 9/30
 273/447
 5,857,674 A * 1/1999 Legrand A63F 3/00145
 273/153 S
 7,374,481 B2 * 5/2008 Rehkemper A63F 9/00
 273/143 A
 8,814,625 B1 * 8/2014 Long A63H 33/26
 446/175
 8,857,817 B2 * 10/2014 Cruz-Rivera A63F 3/00006
 273/287
 10,427,032 B1 * 10/2019 Lin A63F 3/04
 2004/0155403 A1 * 8/2004 Carr A63F 3/00
 273/243
 2006/0134589 A1 * 6/2006 Goodwin G09B 23/28
 434/259
 2007/0235934 A1 * 10/2007 Krejcik A63F 3/00214
 273/271
 2020/0282299 A1 * 9/2020 Morris A63F 9/0666

* cited by examiner

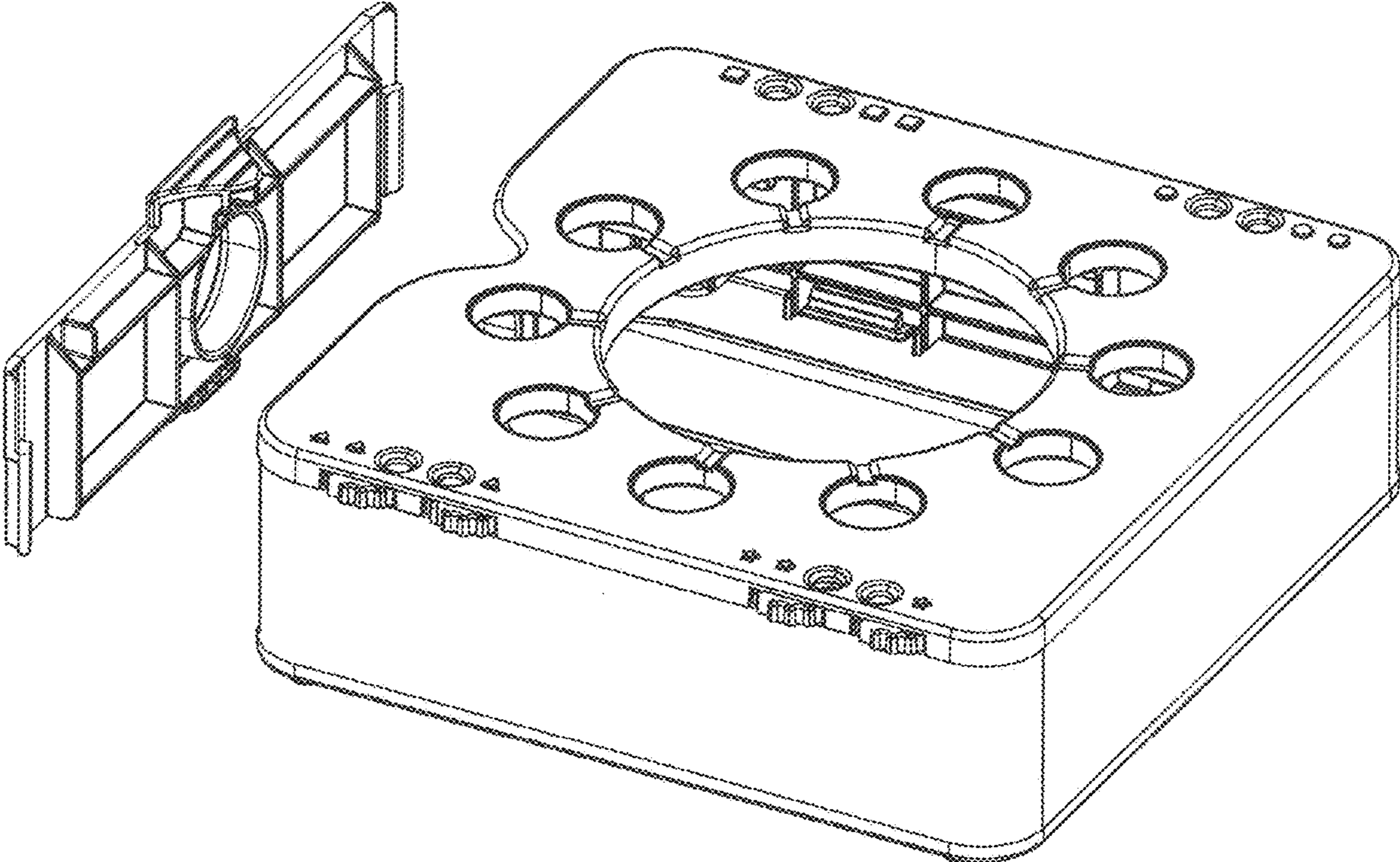

FIG. 1

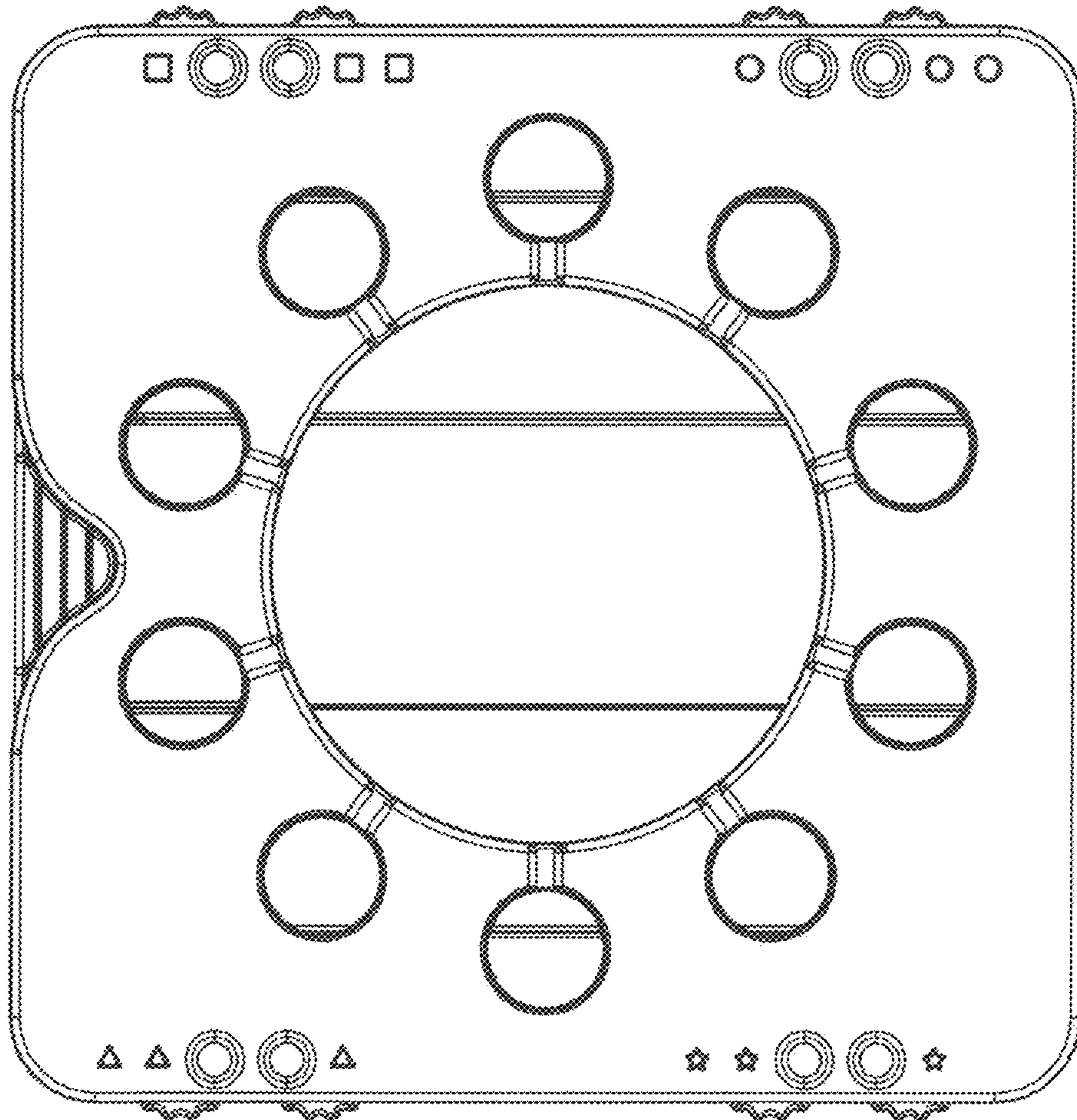

FIG. 2

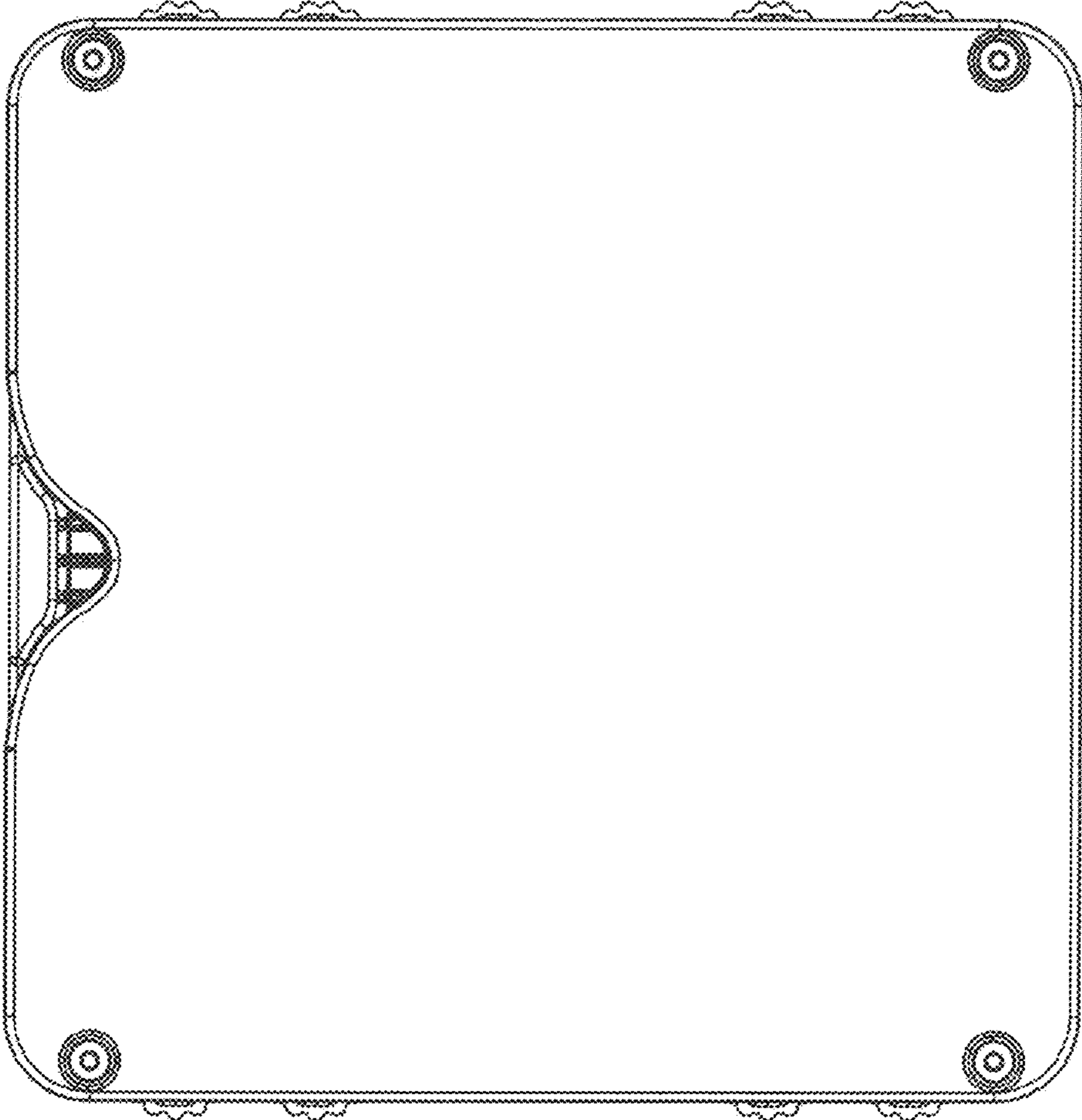

FIG. 3

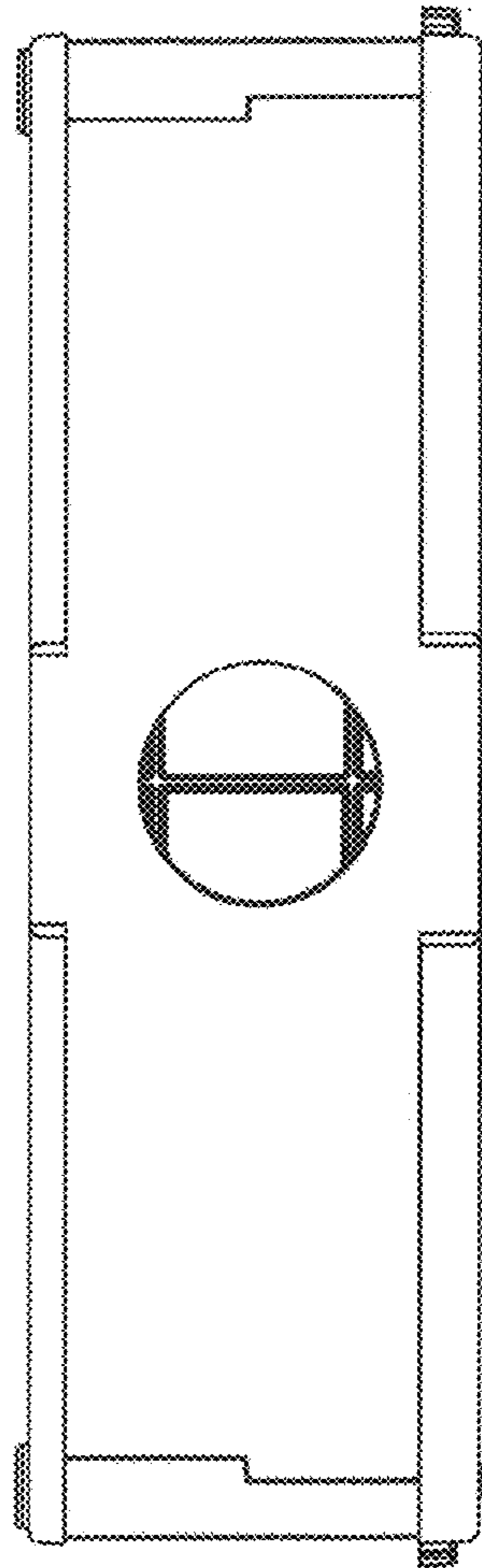

FIG. 4

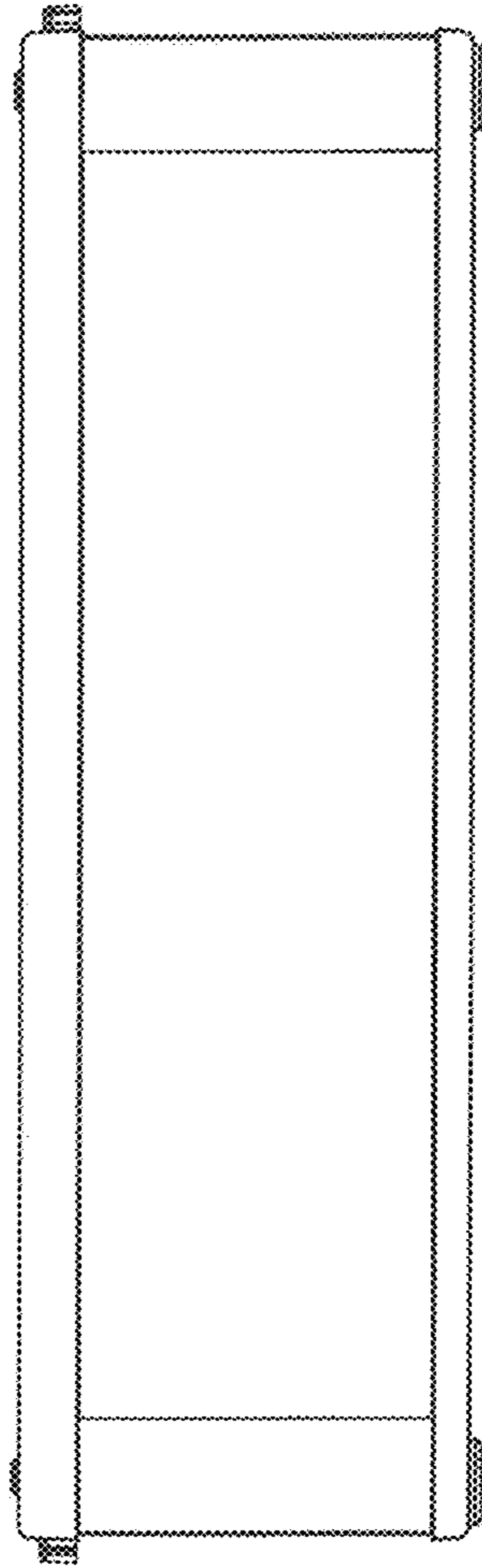

FIG. 5

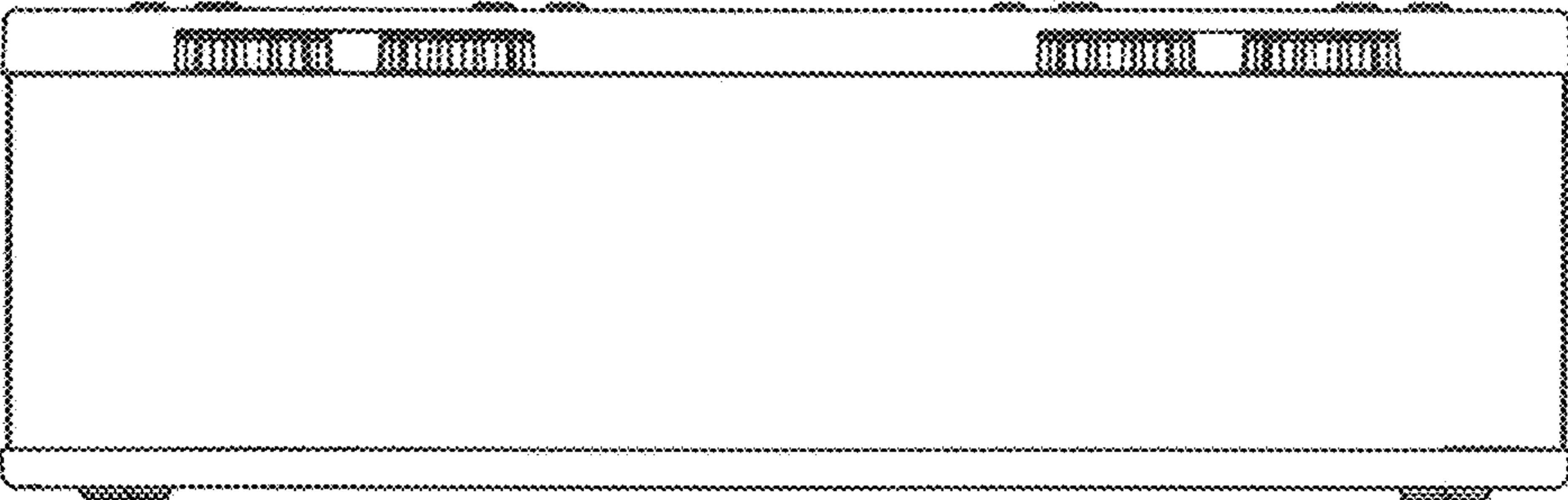

FIG. 6

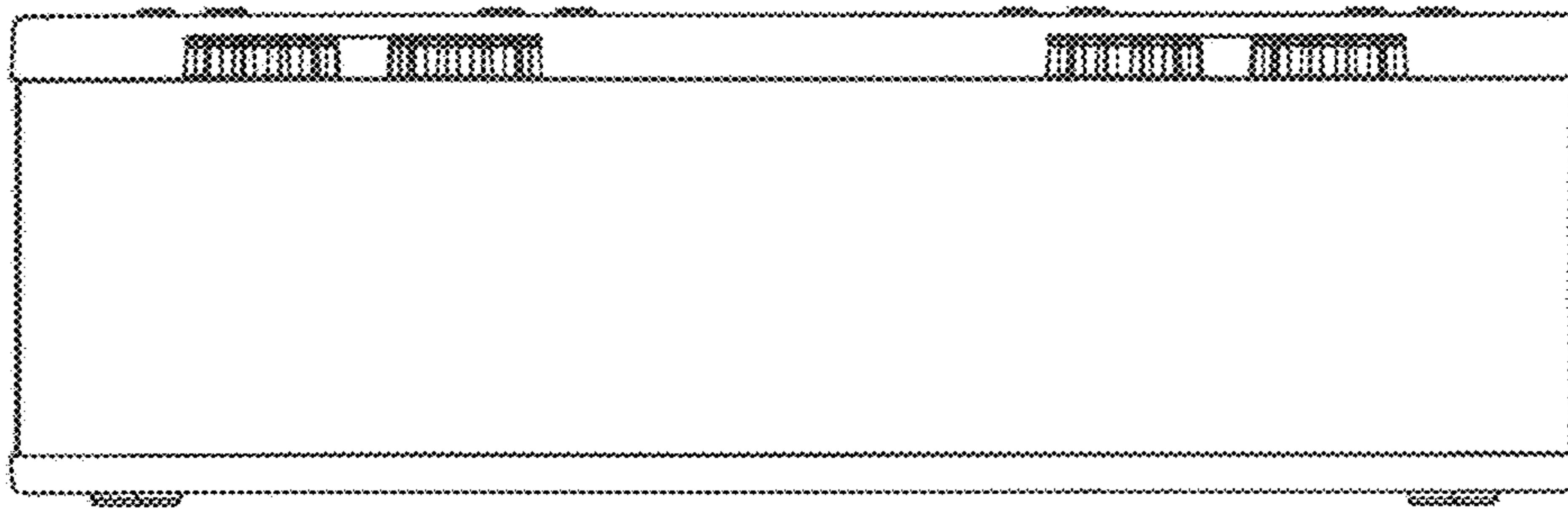

FIG. 7

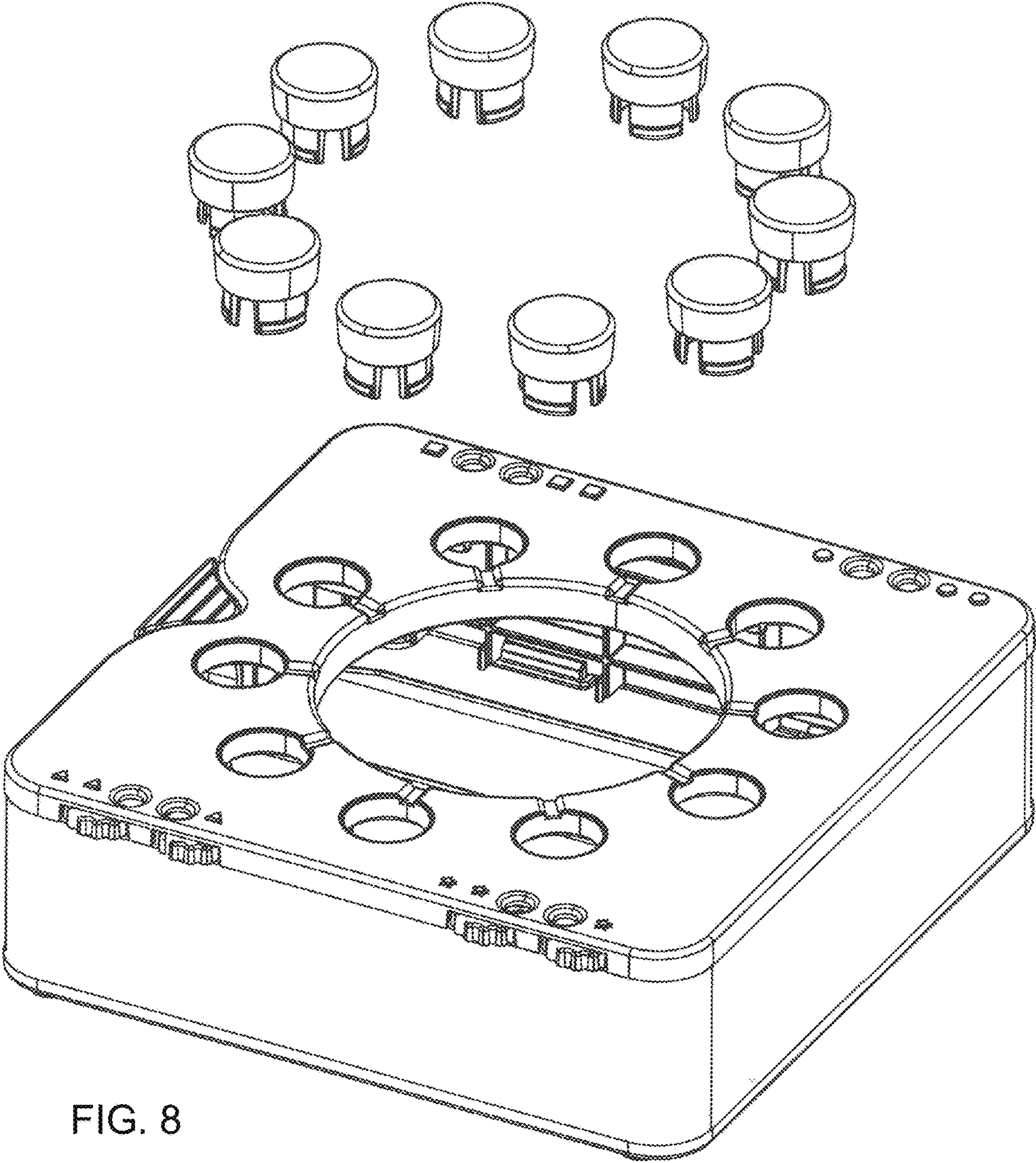

FIG. 8

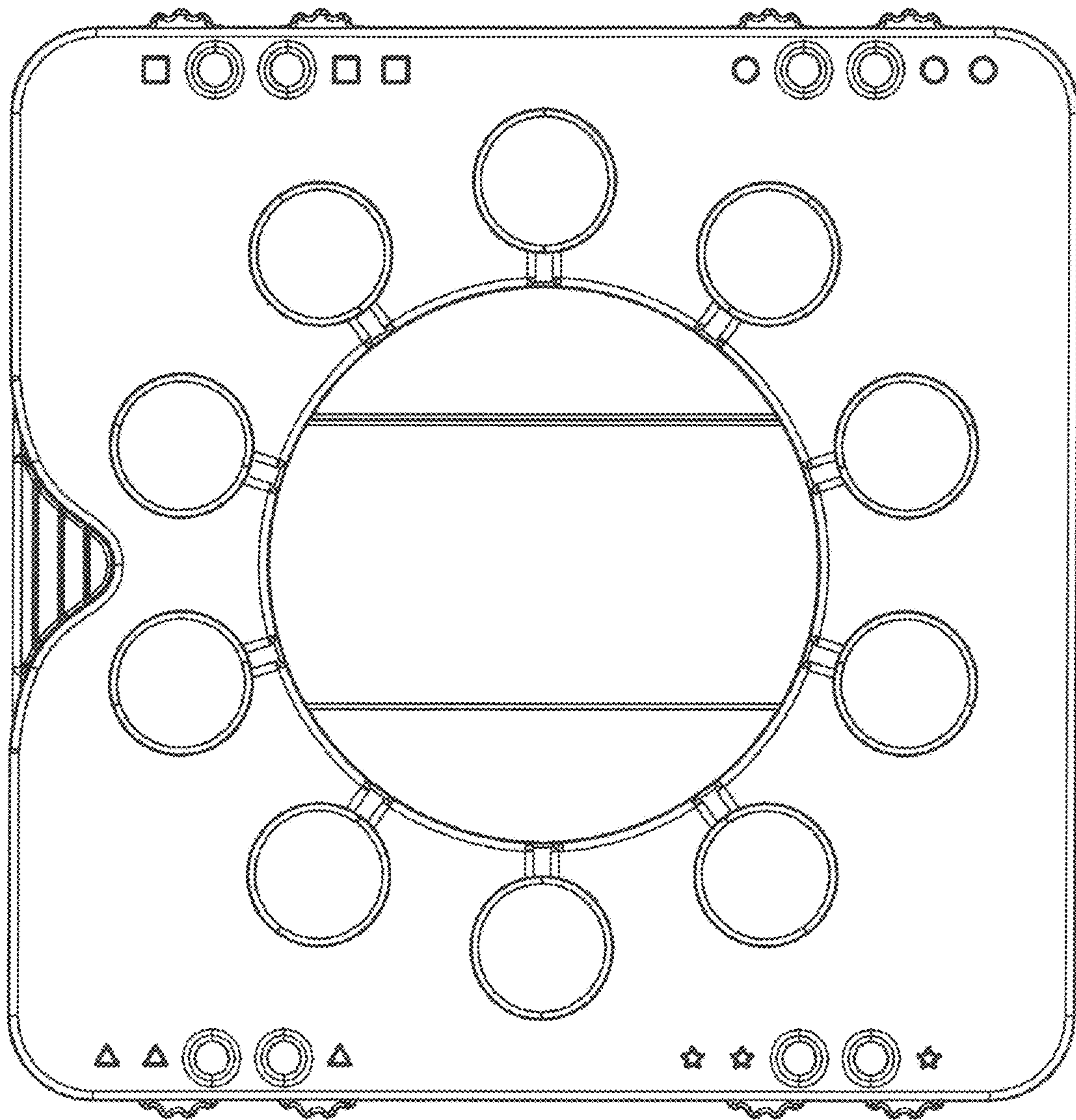

FIG. 9

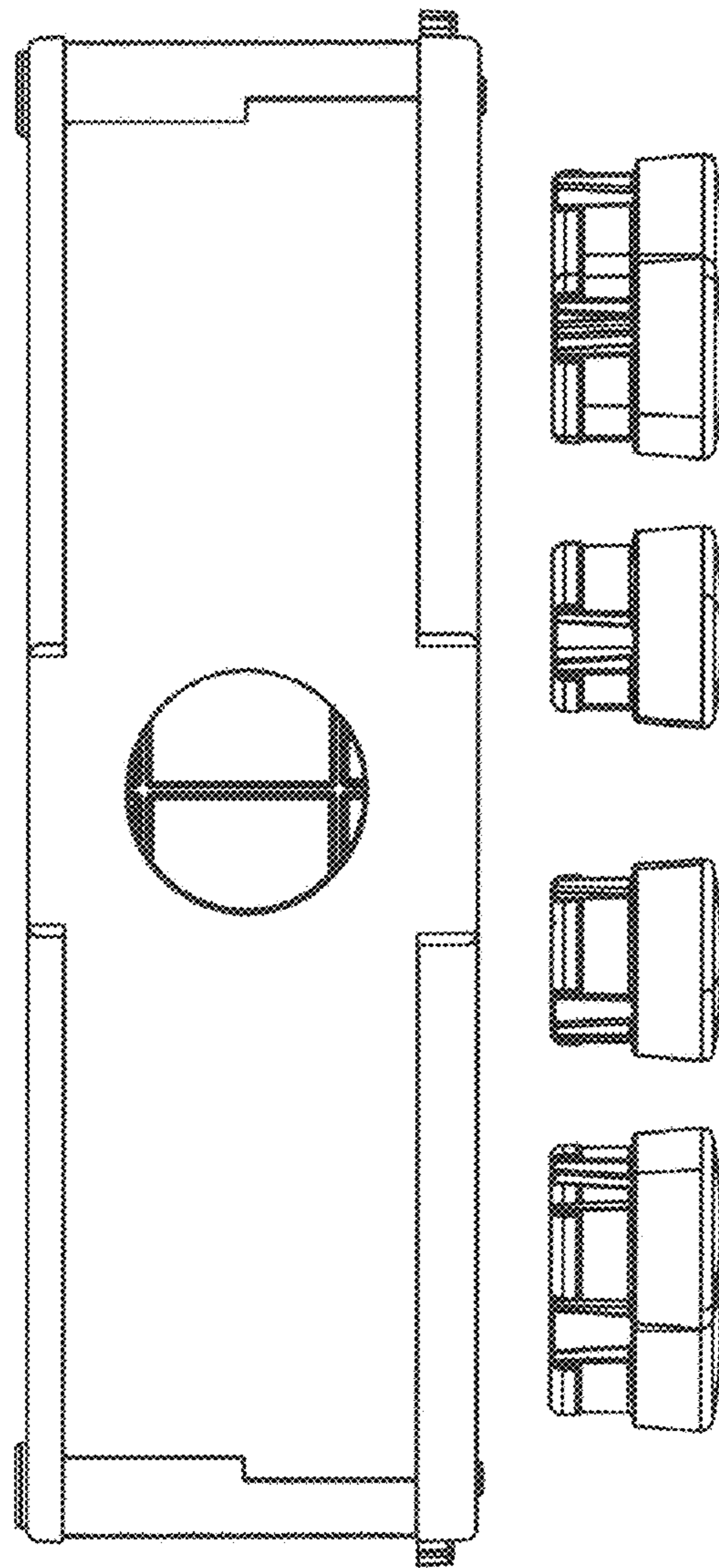

FIG. 10

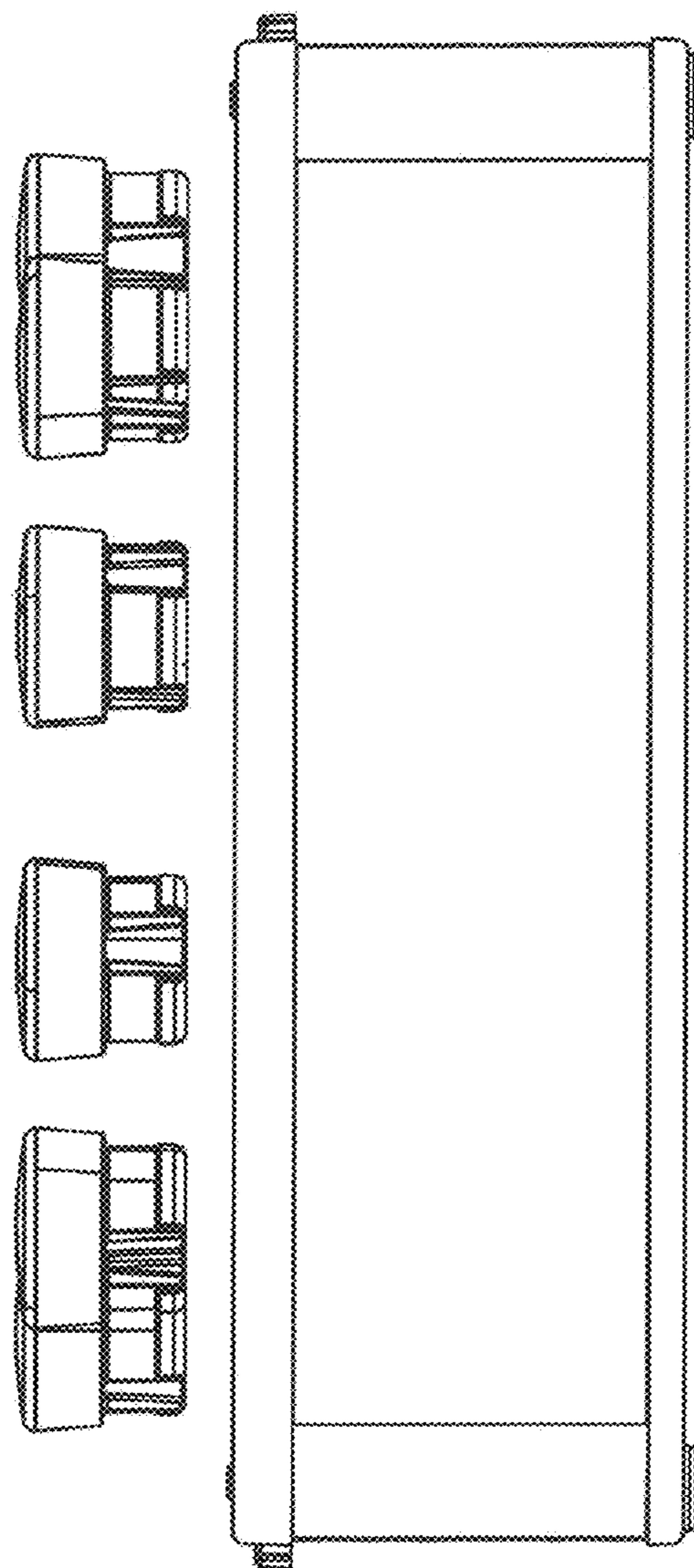

FIG. 11

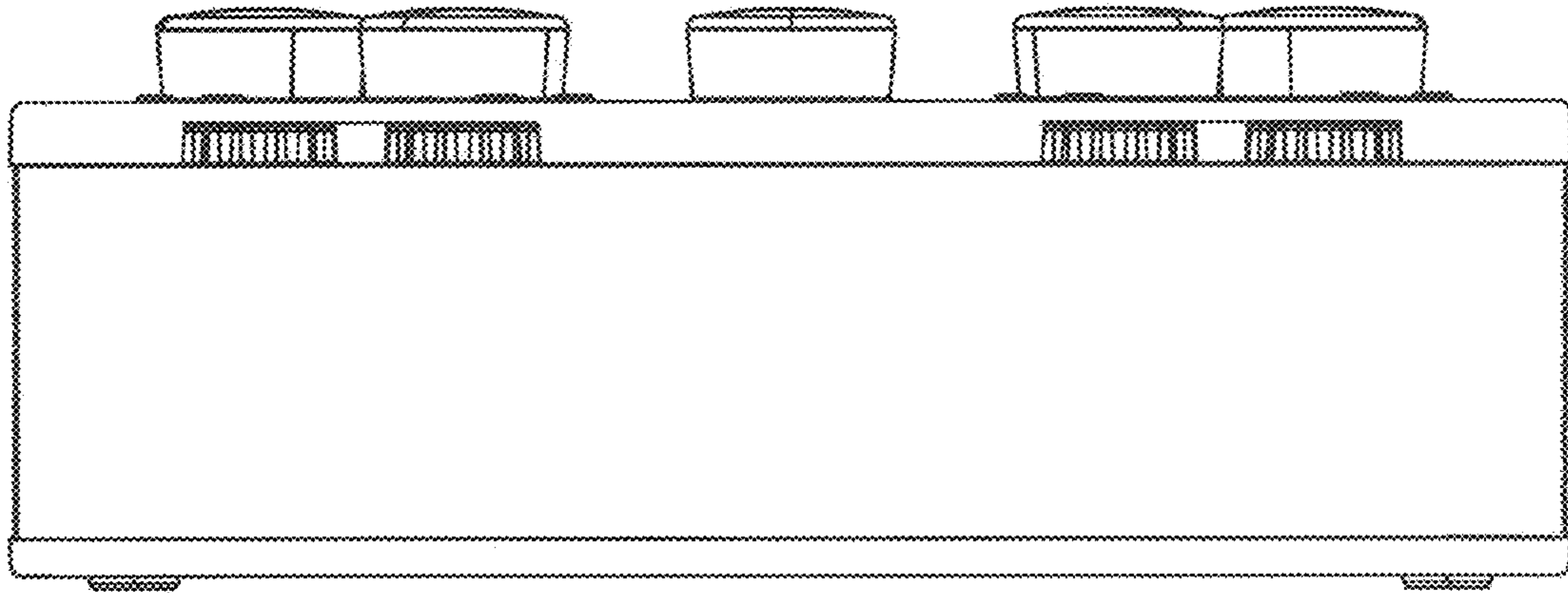

FIG. 12

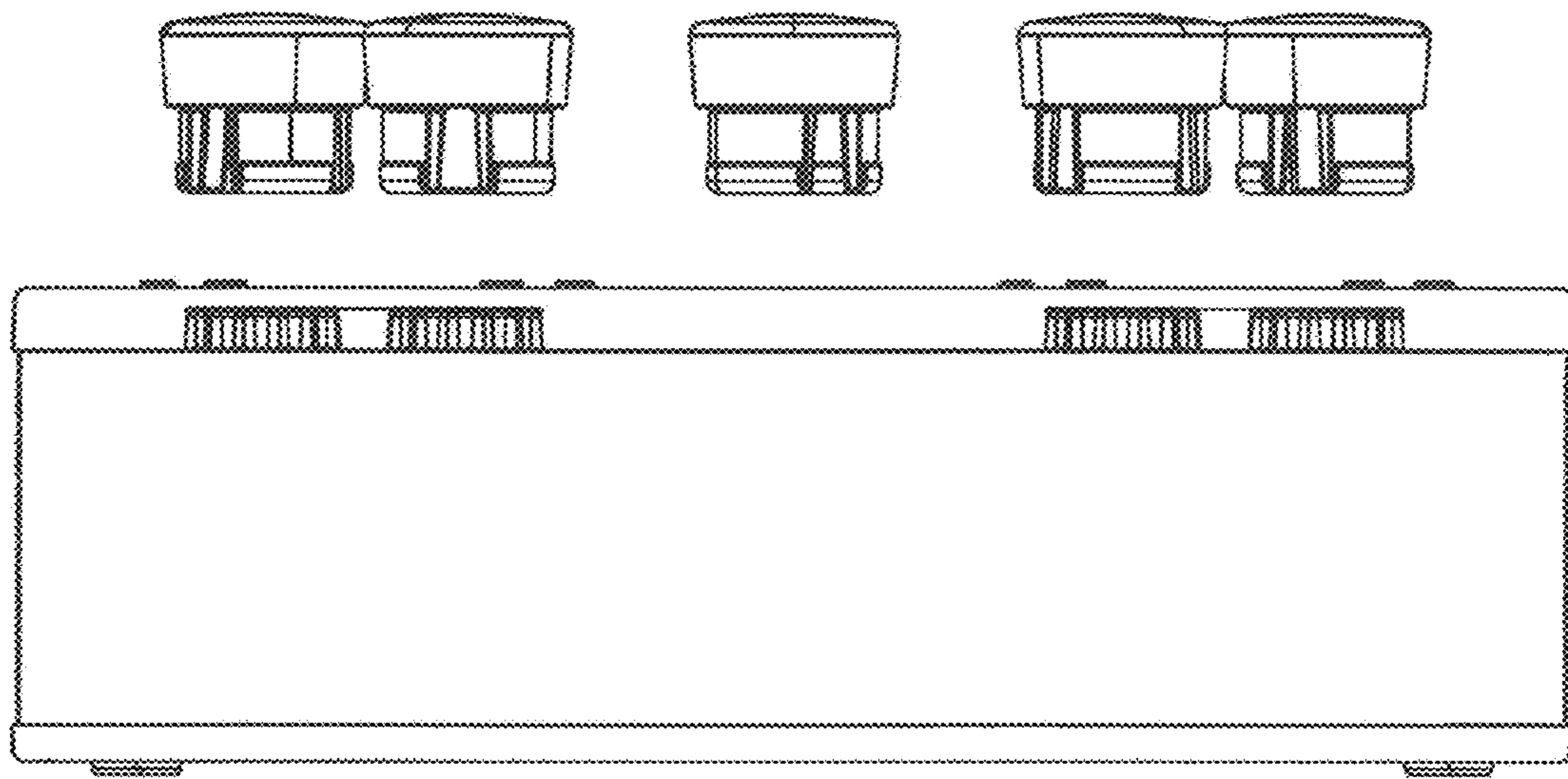

FIG. 13