



US00D918202S

(12) **United States Design Patent**
Natsume et al.

(10) **Patent No.:** **US D918,202 S**

(45) **Date of Patent:** **** May 4, 2021**

(54) **HEADSET WITH HEAD STRAP**

(71) Applicant: **Magic Leap, Inc.**, Plantation, FL (US)

(72) Inventors: **Shigeru Natsume**, Weston, FL (US);
Masamune Kaji, Plantation, FL (US);
Sarah Hoit, Fort Lauderdale, FL (US);
James William Palmer, Miami, FL
(US); **Jason Paul Hale**, Pembroke
Pines, FL (US); **Donald W. Burnette**,
Plantation, FL (US)

(73) Assignee: **Magic Leap, Inc.**, Plantation, FL (US)

(**) Term: **15 Years**

(21) Appl. No.: **29/722,586**

(22) Filed: **Jan. 30, 2020**

(51) **LOC (13) Cl.** **14-02**

(52) **U.S. Cl.**
USPC **D14/372**

(58) **Field of Classification Search**
USPC D14/372, 496, 432, 371, 125, 126, 129,
D14/299; D16/300-342; 351/158, 153,
351/144; 345/7-9, 905; 455/344;
348/115, 53, 121, 739
CPC G02B 27/017; G02B 27/0158; G02B
27/0161; G02B 27/0181; G02B 27/0185;
G02B 27/0189

See application file for complete search history.

(56) **References Cited**

U.S. PATENT DOCUMENTS

D796,503 S * 9/2017 Natsume D14/372
D796,505 S * 9/2017 Natsume D14/372

D836,105 S * 12/2018 Natsume D14/372
D836,107 S * 12/2018 Natsume D14/372
D836,109 S * 12/2018 Natsume D14/372
D836,633 S * 12/2018 Natsume D14/372
D845,296 S * 4/2019 Natsume D14/372
D845,297 S * 4/2019 Natsume D14/372
D857,693 S * 8/2019 Natsume D14/372
D862,464 S * 10/2019 Natsume D14/372
D875,729 S * 2/2020 Natsume D14/372
D900,099 S * 10/2020 Park D14/372

* cited by examiner

Primary Examiner — Austin Murphy

(74) *Attorney, Agent, or Firm* — Fish & Richardson P.C.

(57) **CLAIM**

The ornamental design for a headset with a head strap, as shown and described.

DESCRIPTION

FIG. 1 is a top perspective view of the headset with the head strap.

FIG. 2 is a front view thereof.

FIG. 3 is a back view thereof.

FIG. 4 is a left side view thereof.

FIG. 5 is a right side view thereof.

FIG. 6 is a top view thereof; and,

FIG. 7 is a bottom view thereof.

In some implementations, the headset includes multiple pairs of cameras positioned around the lenses of the headset, as illustrated in FIGS. 1-7.

The broken lines illustrate environmental features that form no part of the claimed design.

1 Claim, 4 Drawing Sheets

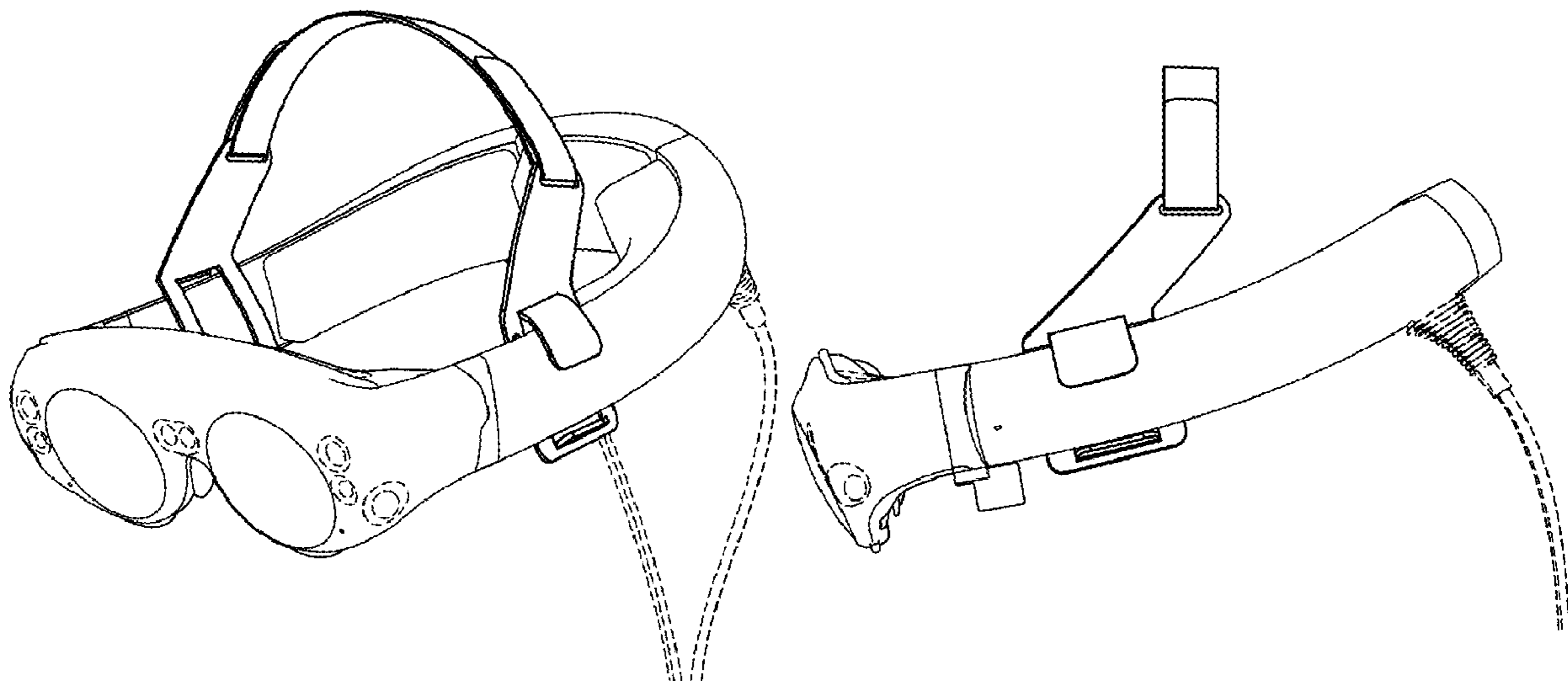

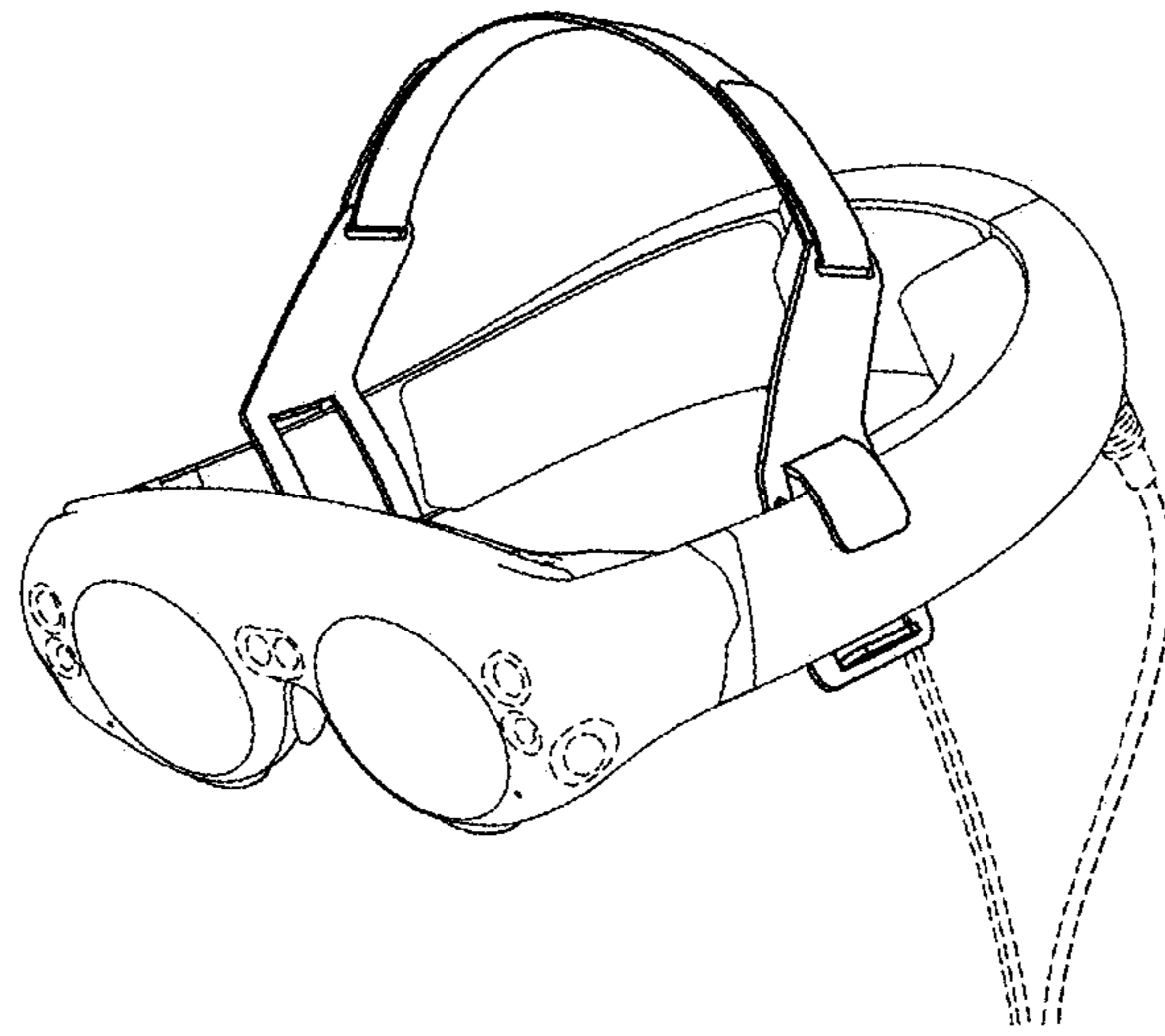

FIG. 1

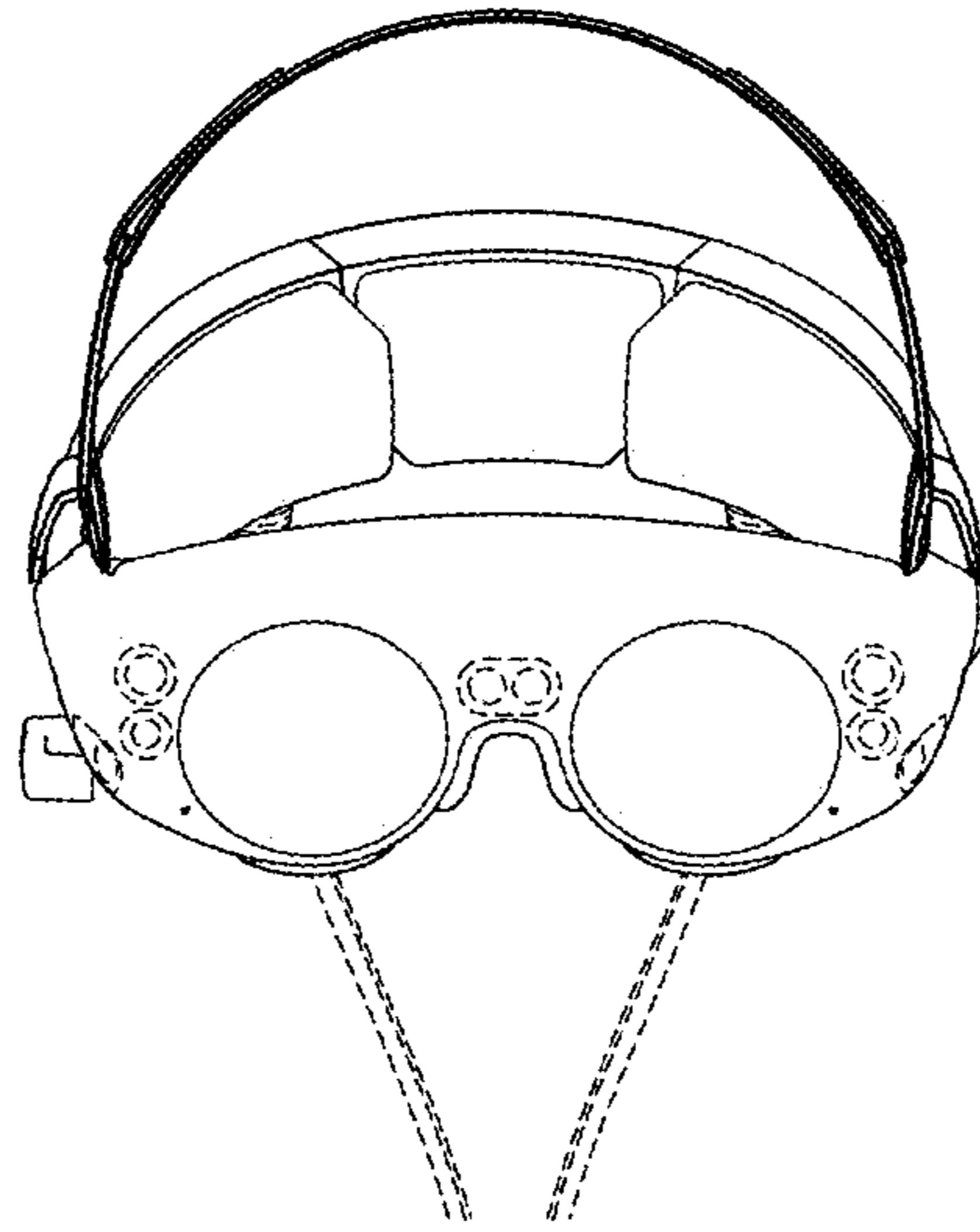

FIG. 2

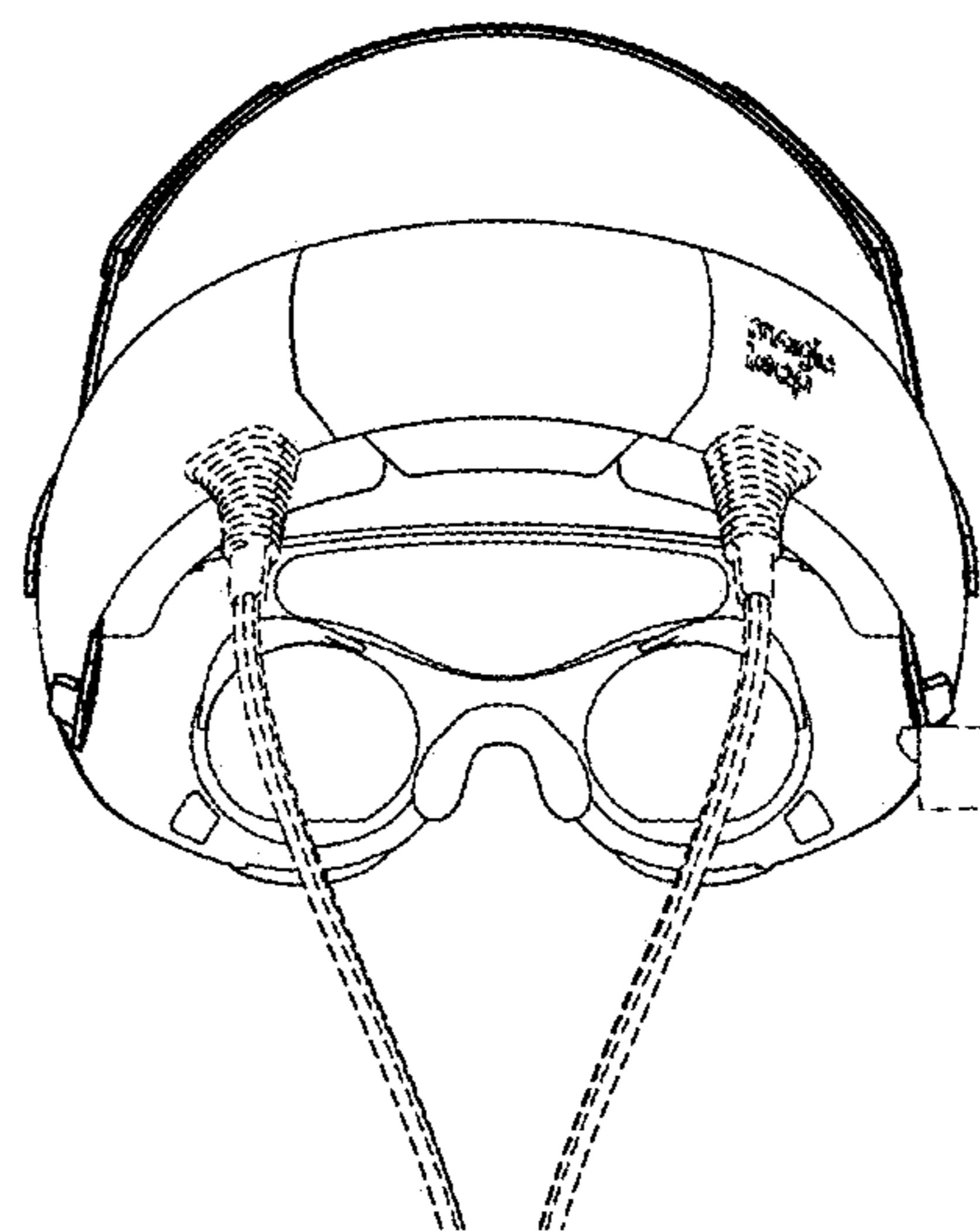

FIG. 3

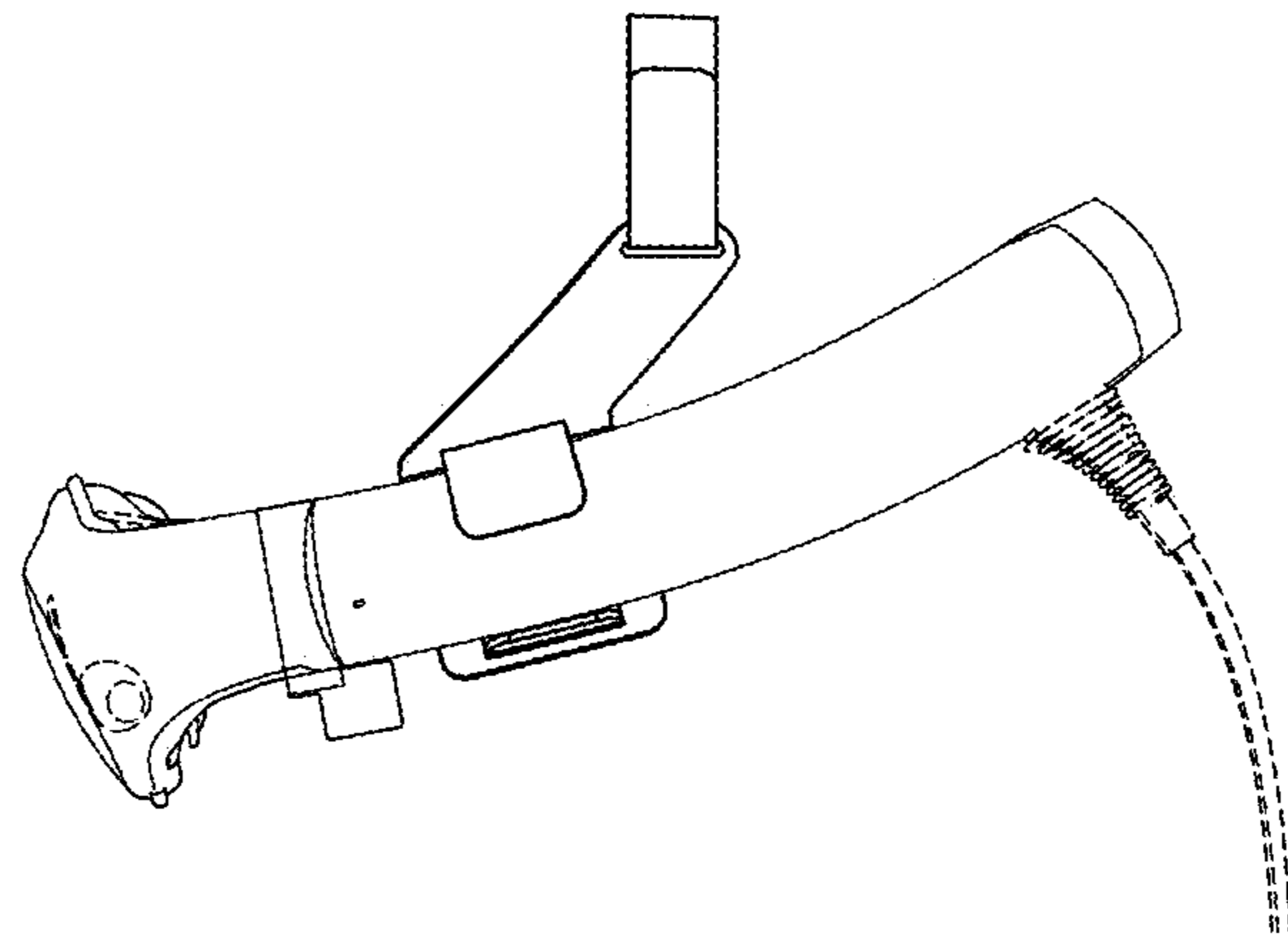

FIG. 4

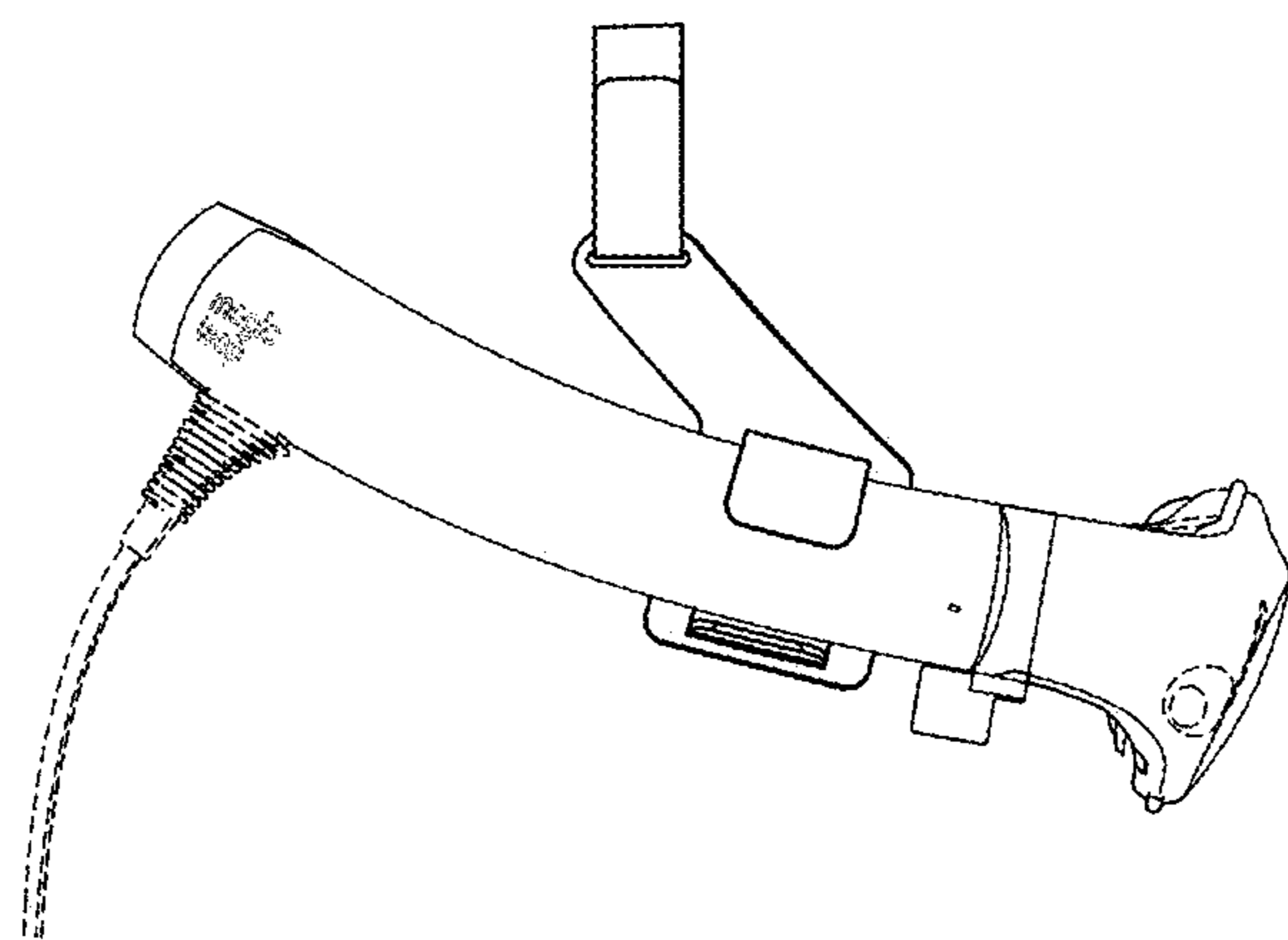

FIG. 5

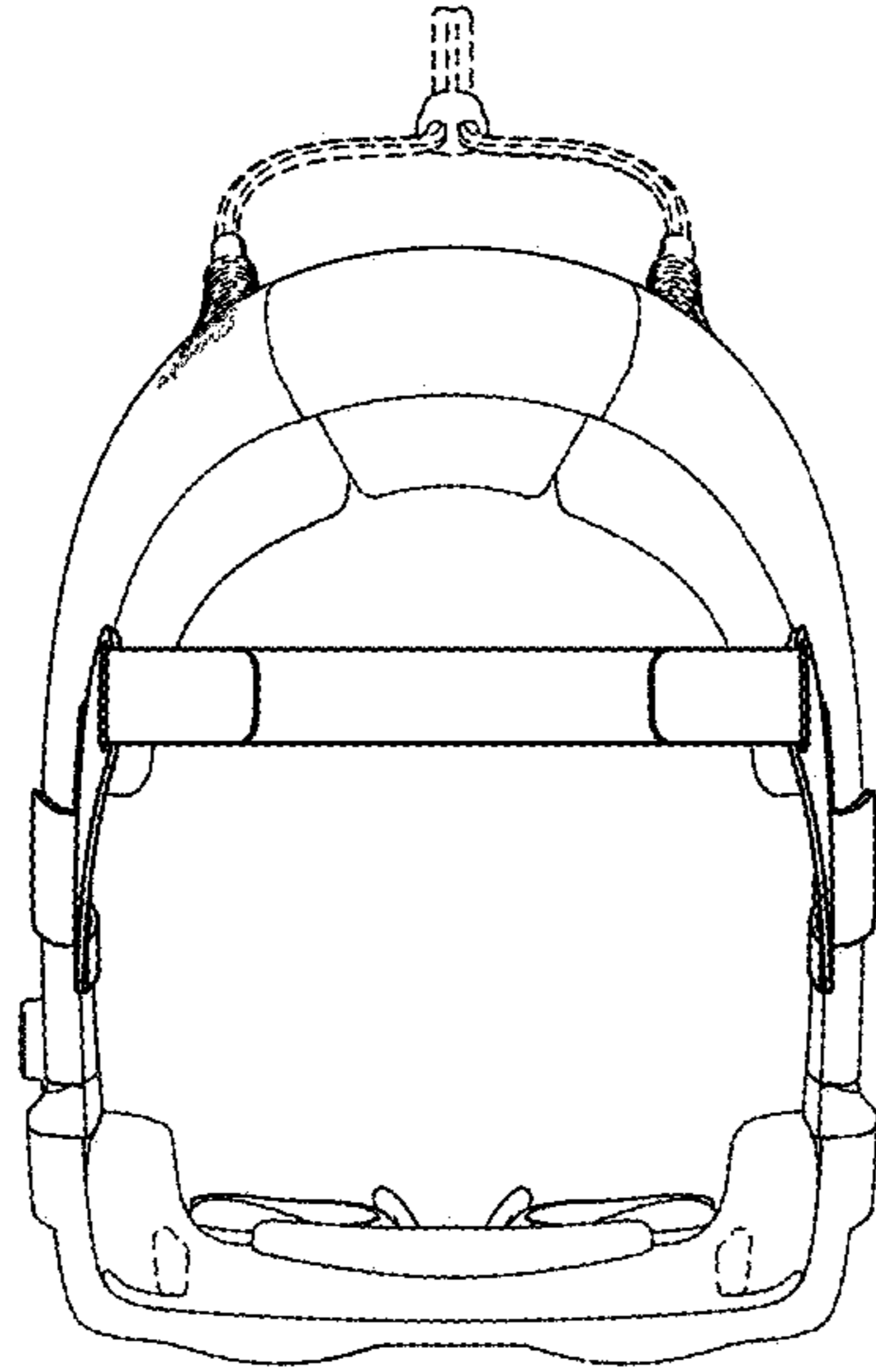

FIG. 6

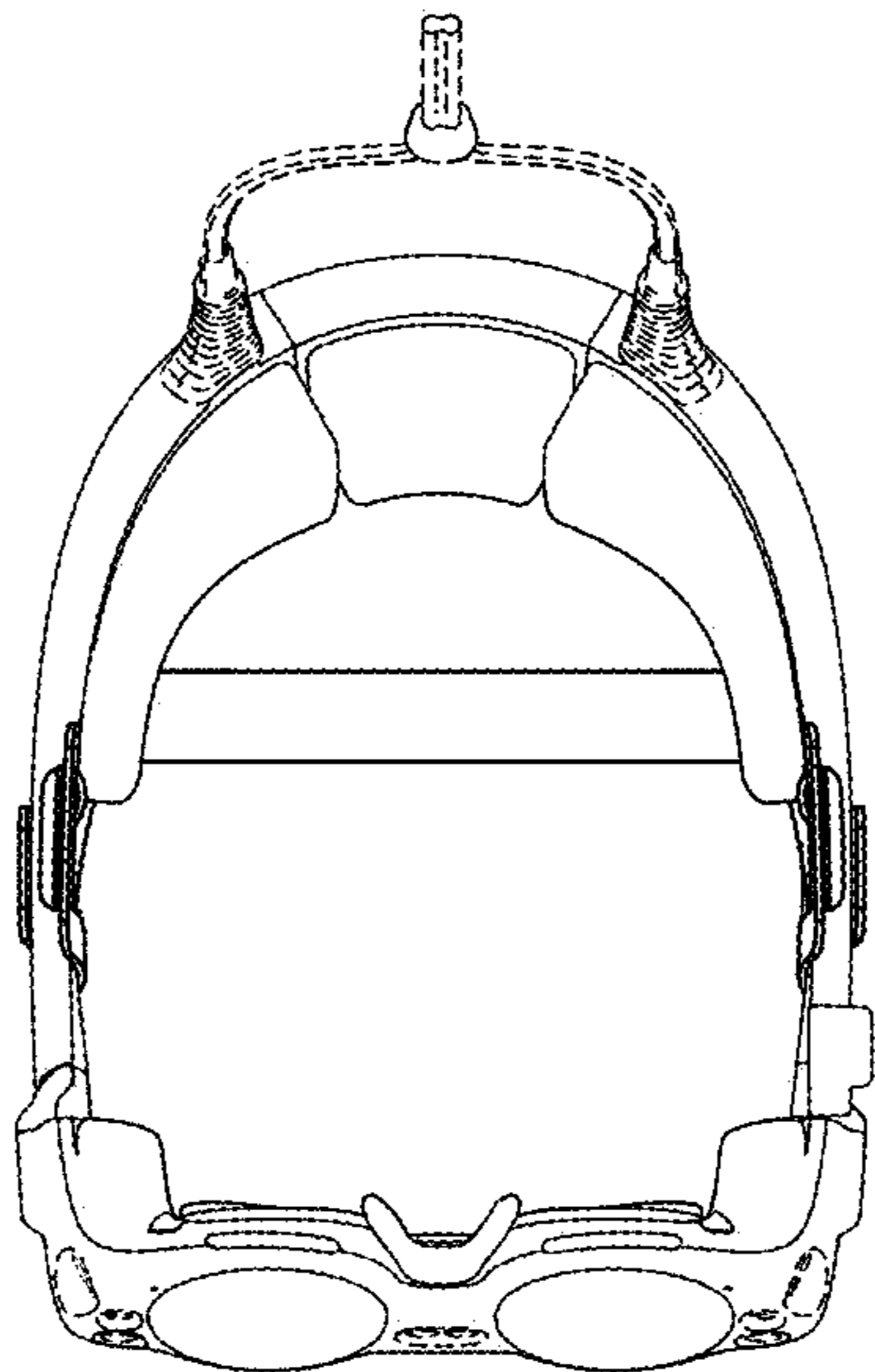

FIG. 7