



US00D918169S

(12) **United States Design Patent** (10) **Patent No.:** **US D918,169 S**
Leeds et al. (45) **Date of Patent:** **** May 4, 2021**

(54) **SPEAKER HOUSING AND STAND**

Primary Examiner — Cynthia R Underwood
(74) *Attorney, Agent, or Firm* — Sheridan Ross P.C.

(71) Applicant: **LEEDS LOOK LISTEN, INC.**,
Corona Del Mar, CA (US)

(72) Inventors: **Daniel Leeds**, Corona Del Mar, CA
(US); **Debra Leeds**, Corona Del Mar,
CA (US); **Steven Eddy**, Sacramento,
CA (US)

(57) **CLAIM**

The ornamental design for a speaker housing and stand, as shown and described.

(73) Assignee: **LEEDS LOOK LISTEN, INC.**,
Corona Del Mar, CA (US)

DESCRIPTION

(**) Term: **15 Years**

FIG. 1 is a front perspective view of the speaker housing and stand;

(21) Appl. No.: **29/661,167**

FIG. 2 is a rear perspective thereof;

(22) Filed: **Aug. 24, 2018**

FIG. 3 is a front elevation view thereof;

(51) **LOC (13) Cl.** **14-01**

FIG. 4 is a rear elevation view thereof;

(52) **U.S. Cl.**

FIG. 5 is a right elevation view thereof, the left elevation view being the mirror image of FIG. 5;

USPC **D14/204**

FIG. 6 is a top plan view thereof;

(58) **Field of Classification Search**

FIG. 7 is a bottom plan view thereof;

USPC D14/204, 496, 214, 172

FIG. 8 is a front perspective view of the speaker housing and stand according to another embodiment;

CPC H45K 5/0086; H04R 1/02; H04R 1/021;

FIG. 9 is a rear perspective view of the embodiment of FIG. 8;

H04R 1/026; H04R 1/028; H04R 1/403;

FIG. 10 is a front elevation view of the embodiment of FIG. 8;

H04R 1/2803; H04R 5/02; H04R 9/06;

FIG. 11 is a rear elevation view of the embodiment of FIG. 8;

H04R 9/13; H04R 2201/021; H04R

2400/00; H04R 2499/11

FIG. 12 is a right elevation view of the embodiment of FIG. 8, the left elevation view being the mirror image of FIG. 12;

See application file for complete search history.

FIG. 13 is a top plan view of the embodiment of FIG. 8; and, FIG. 14 is a bottom plan view of the embodiment of FIG. 8.

The dotted lines showing portions of a speaker housing and stand are provided for the purpose of illustrating environment and form no part of the claimed design.

(56) **References Cited**

U.S. PATENT DOCUMENTS

D891,394 S *	7/2020	Kim	D14/204
D891,395 S *	7/2020	Kim	D14/204
D894,138 S *	8/2020	Seflic	D14/125
D895,573 S *	9/2020	Koehn	D14/214

* cited by examiner

1 Claim, 14 Drawing Sheets

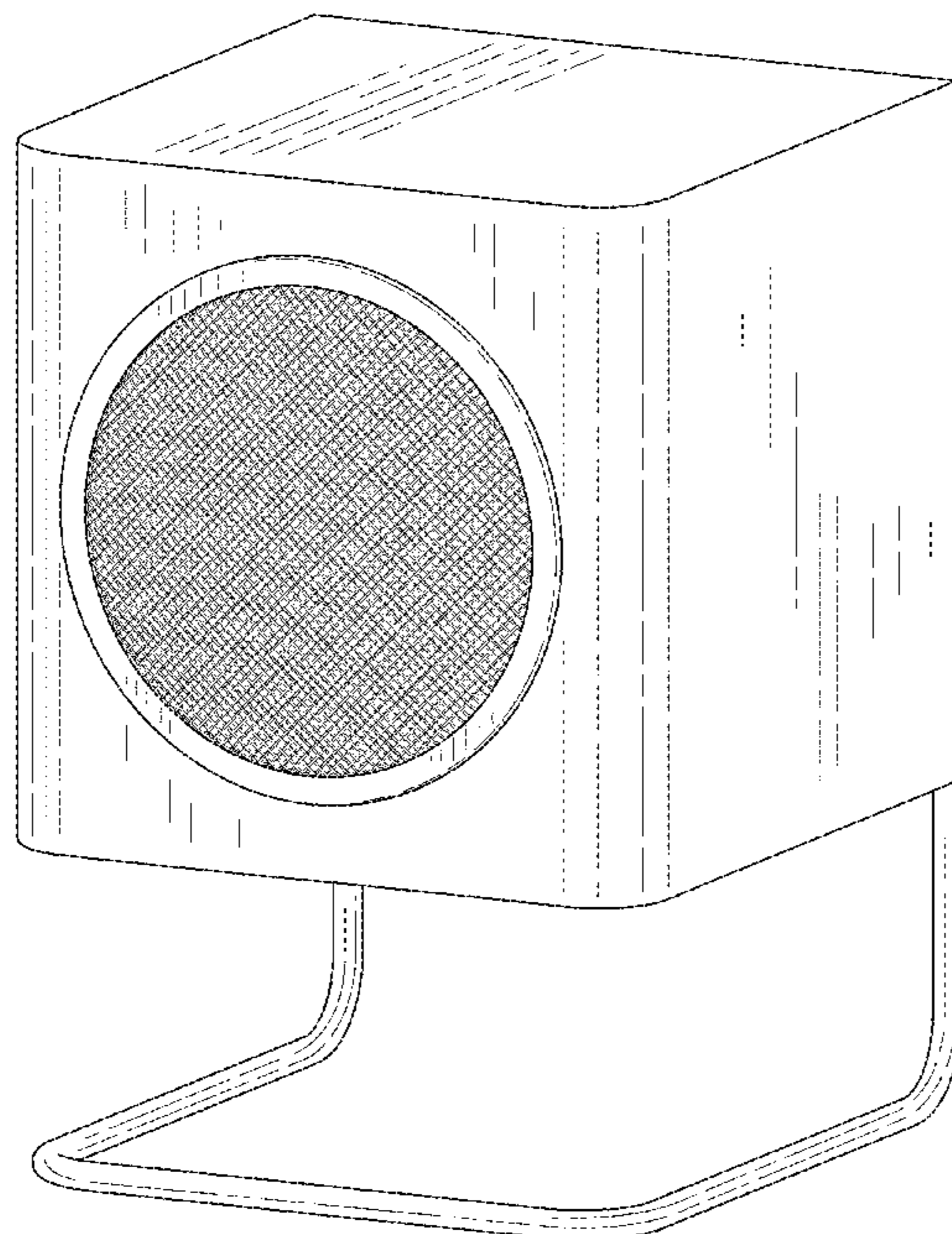

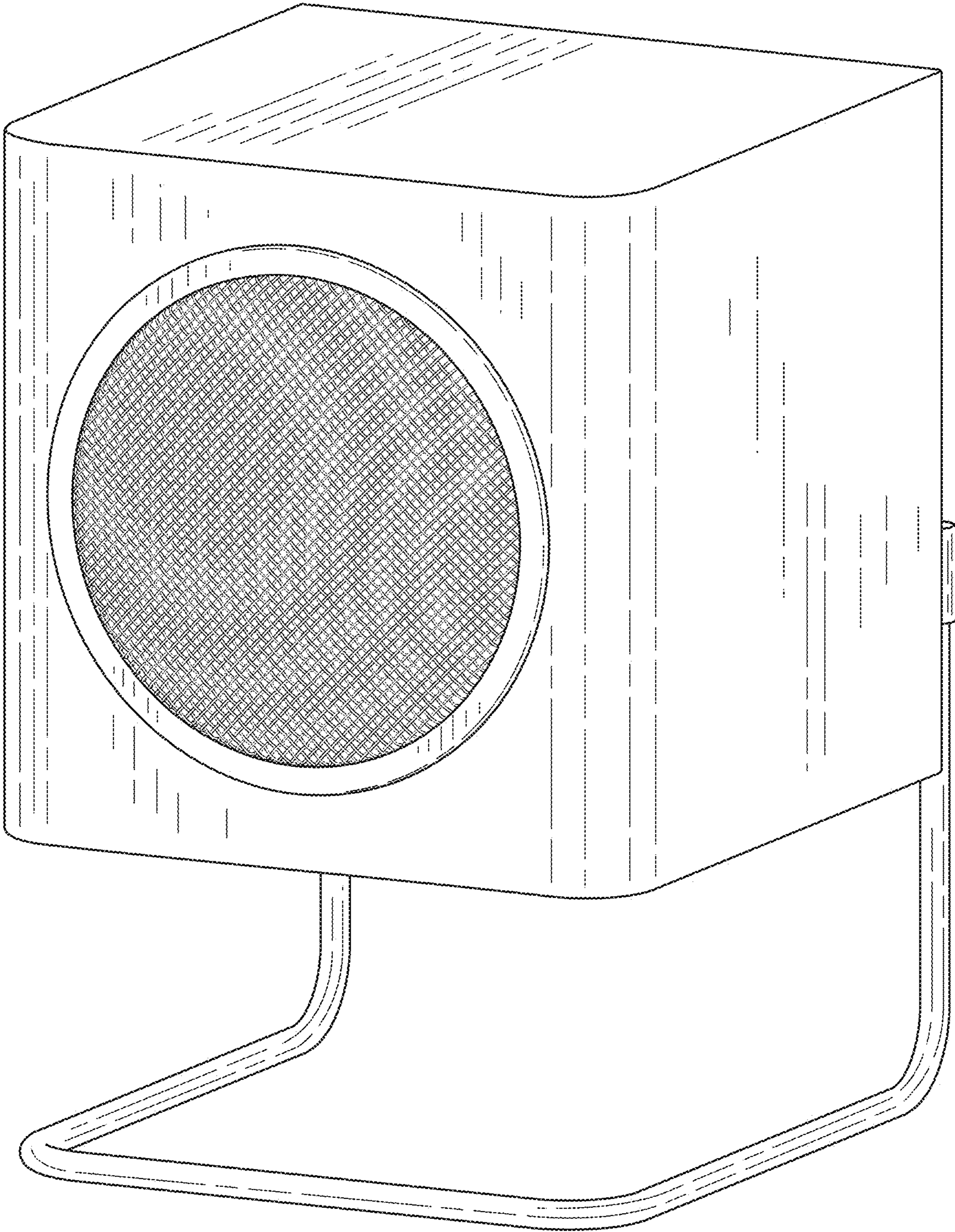

FIG.1

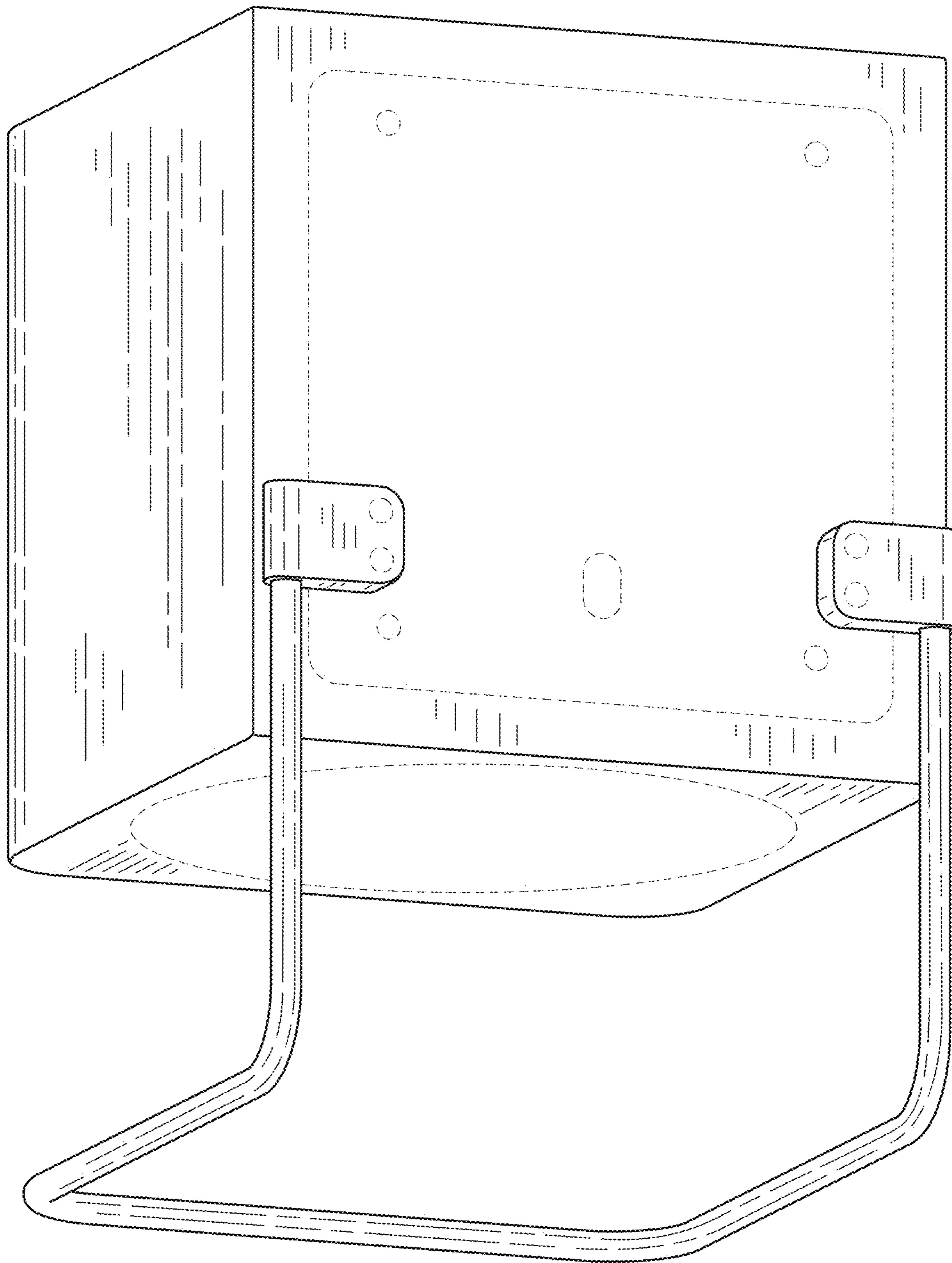

FIG.2

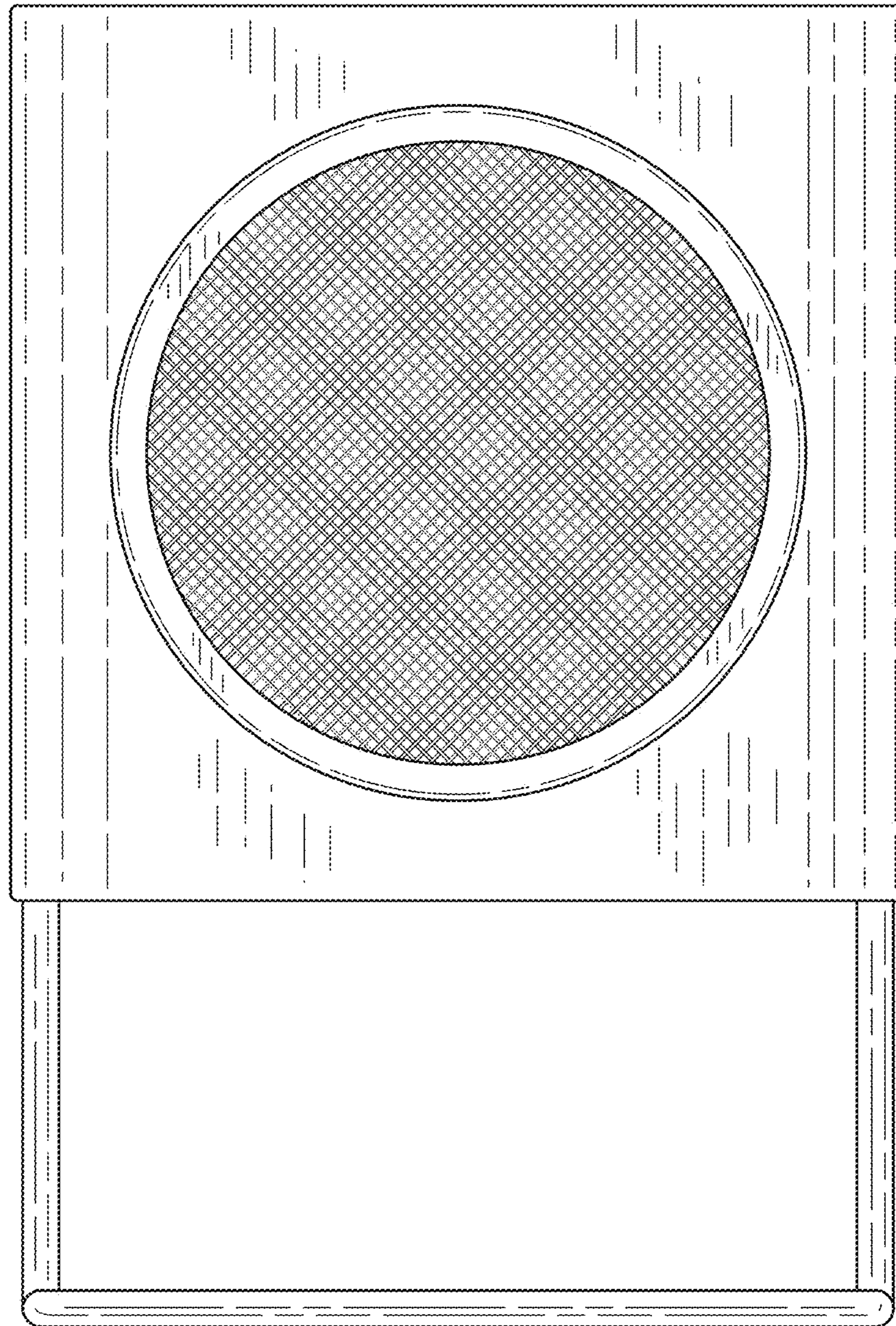

FIG.3

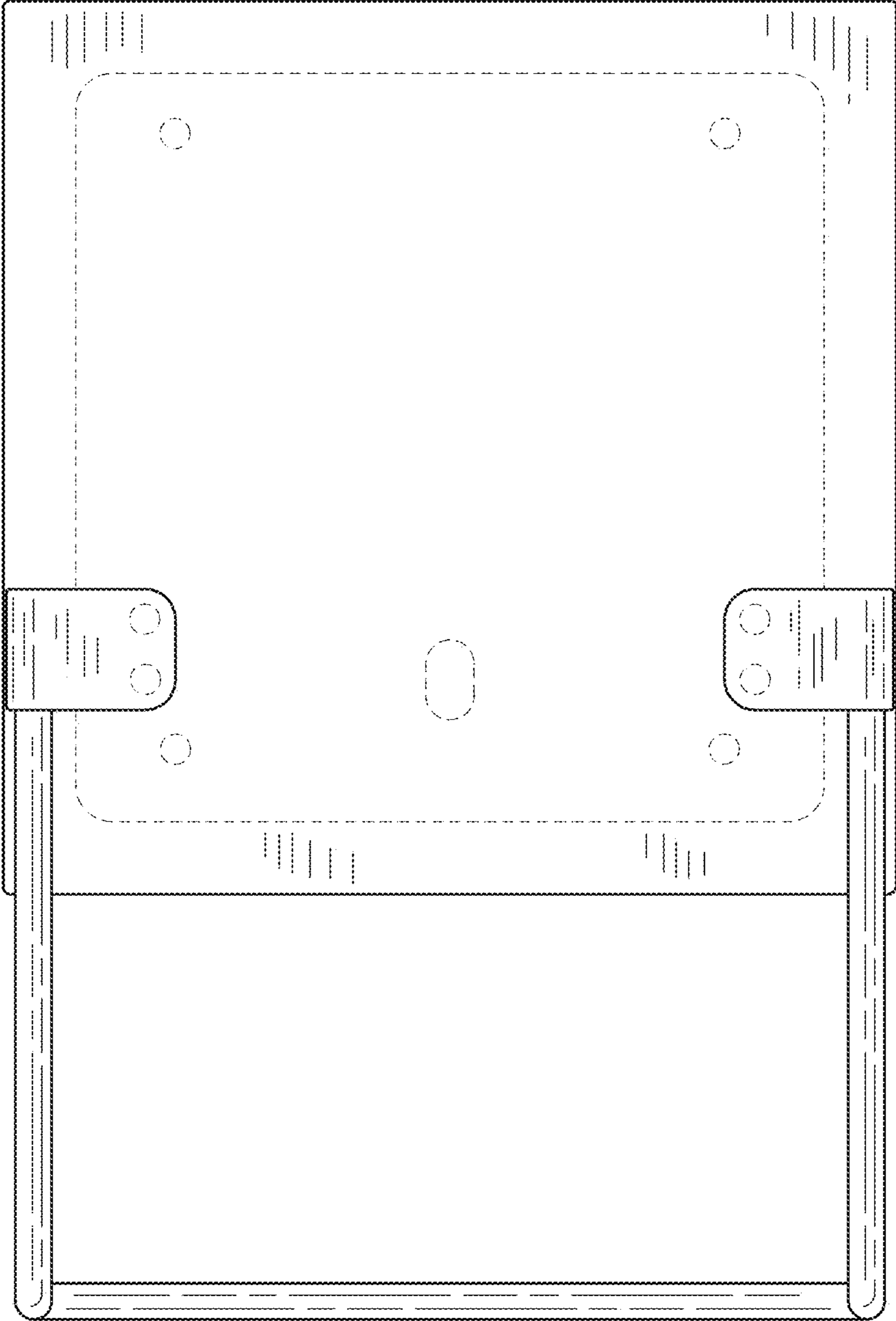

FIG.4

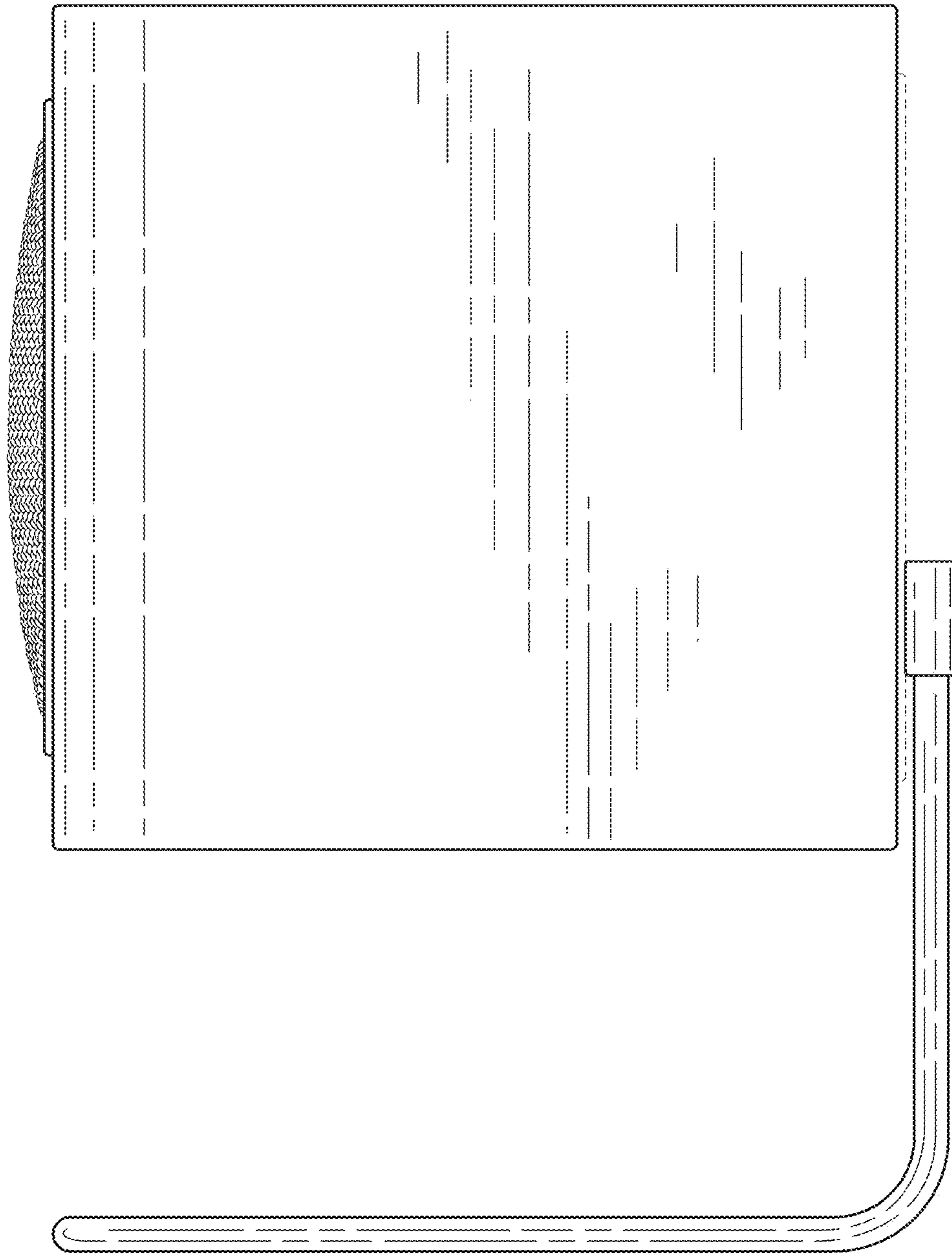

FIG.5

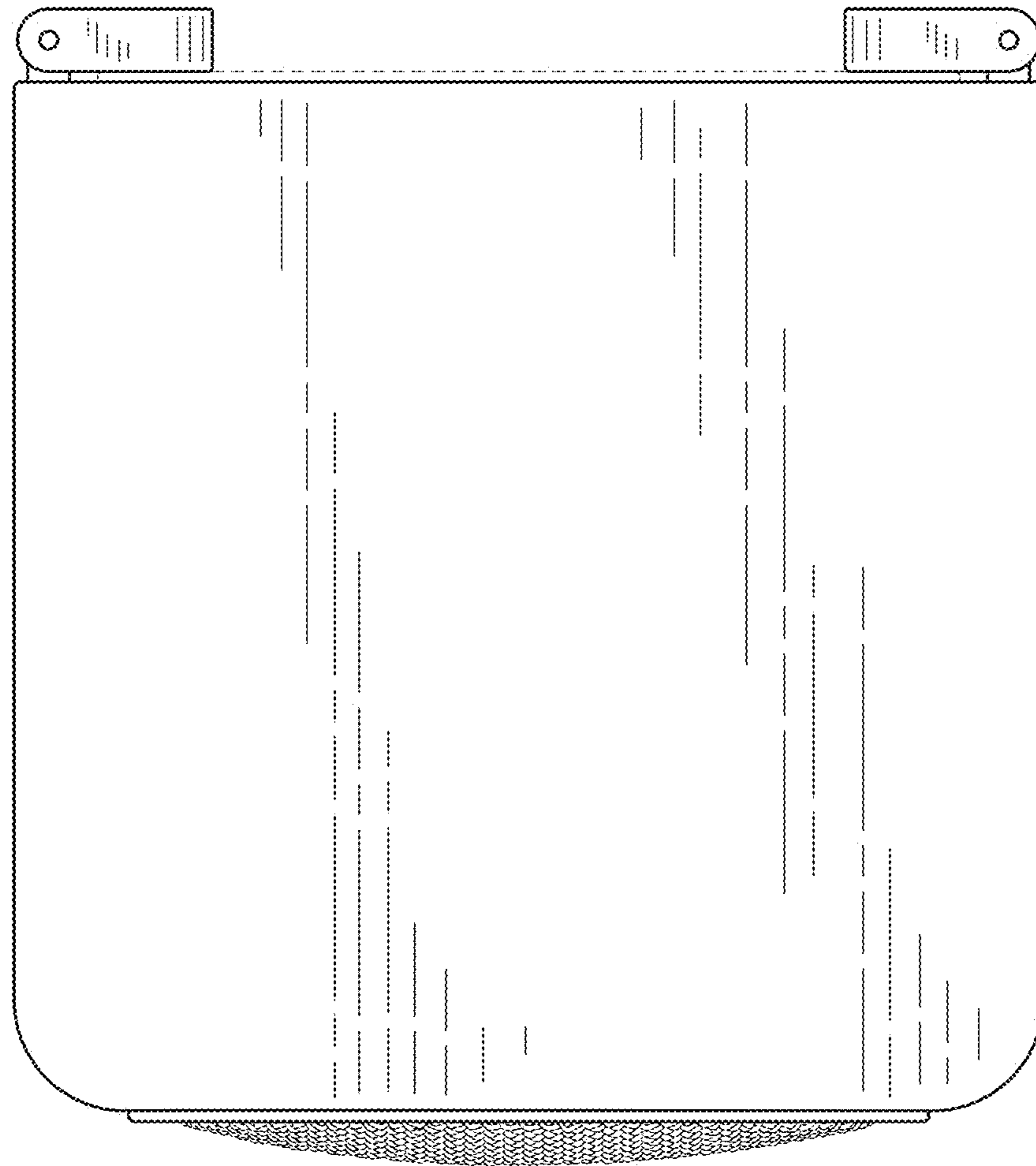

FIG.6

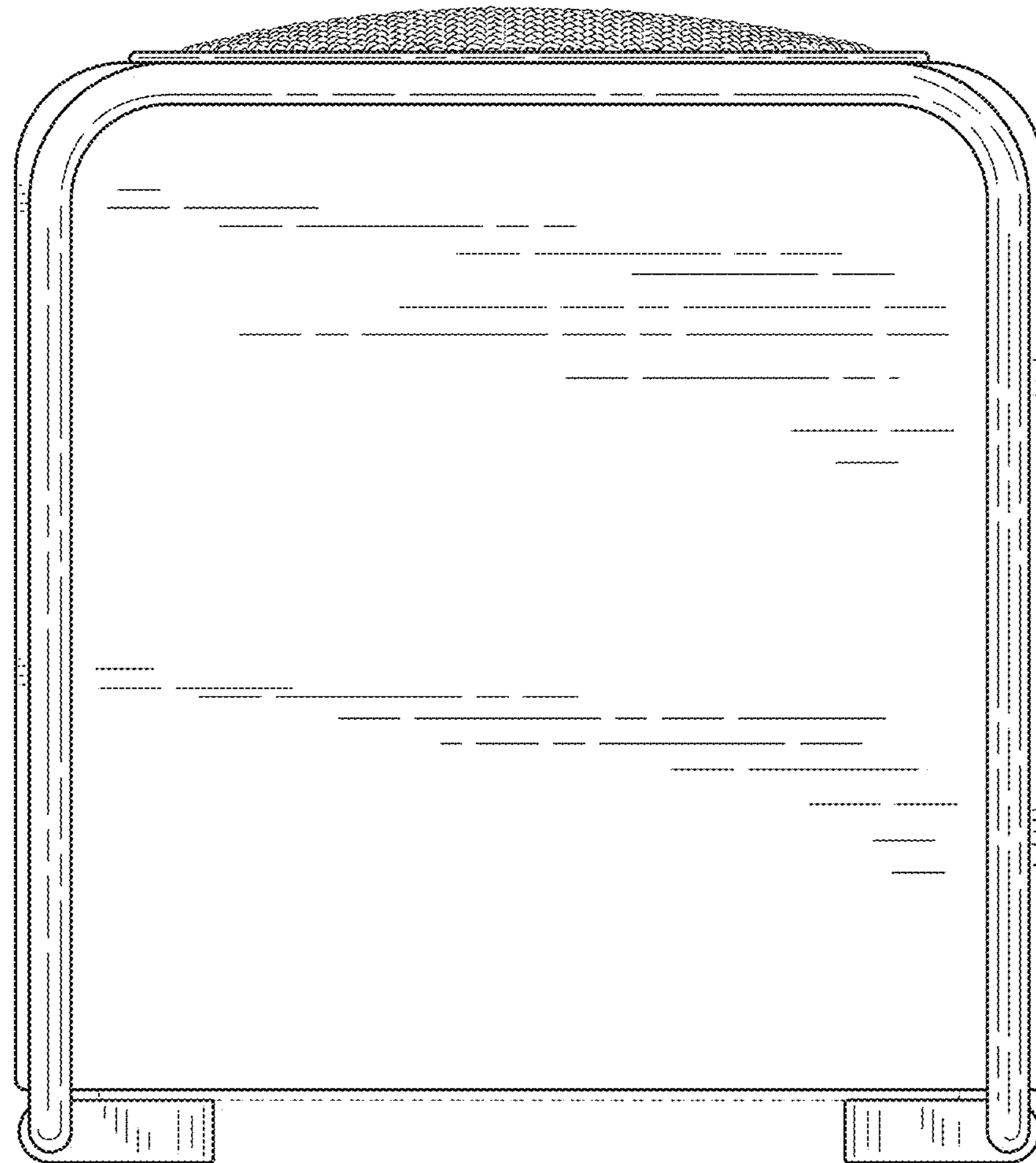

FIG.7

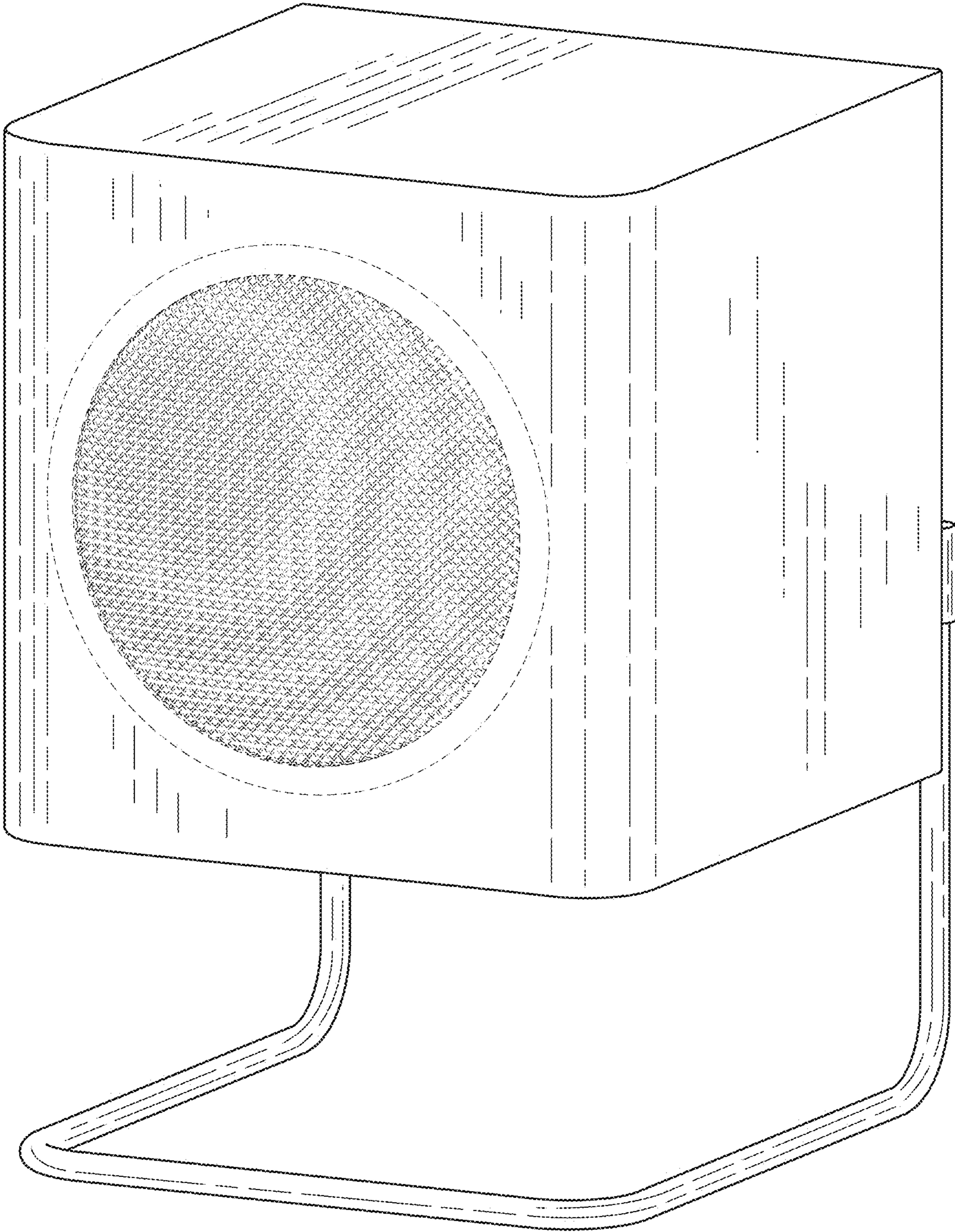

FIG. 8

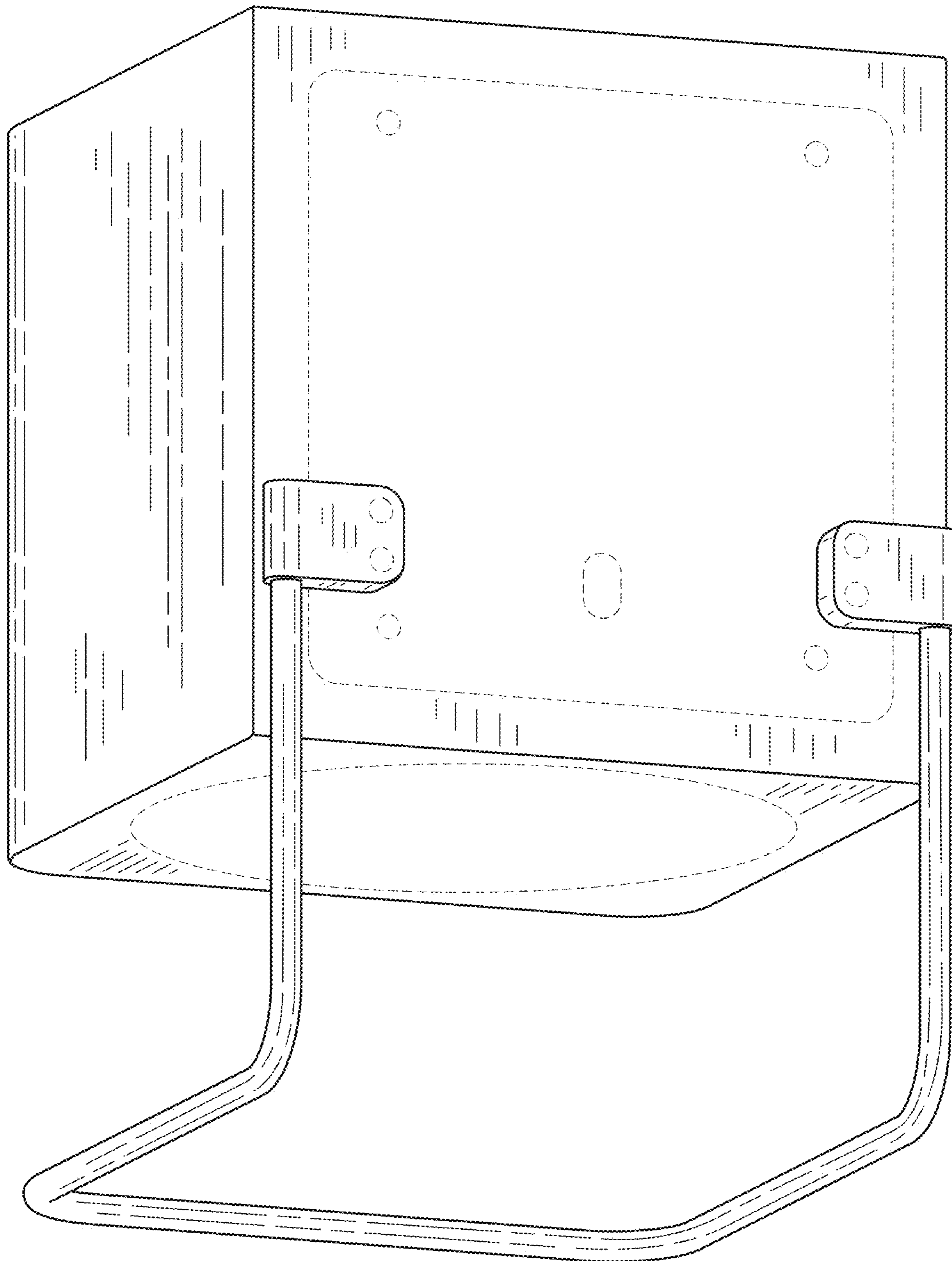

FIG.9

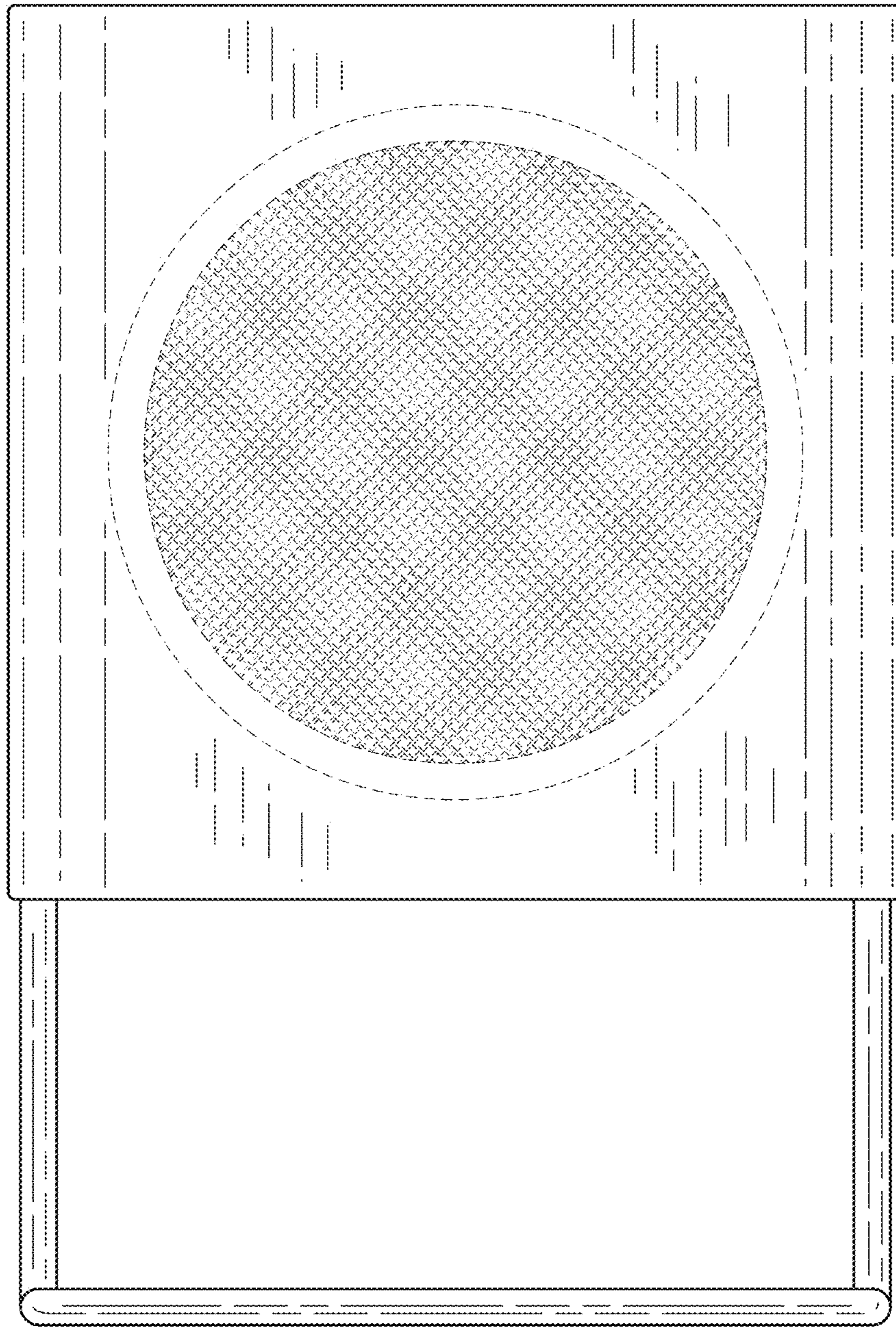

FIG. 10

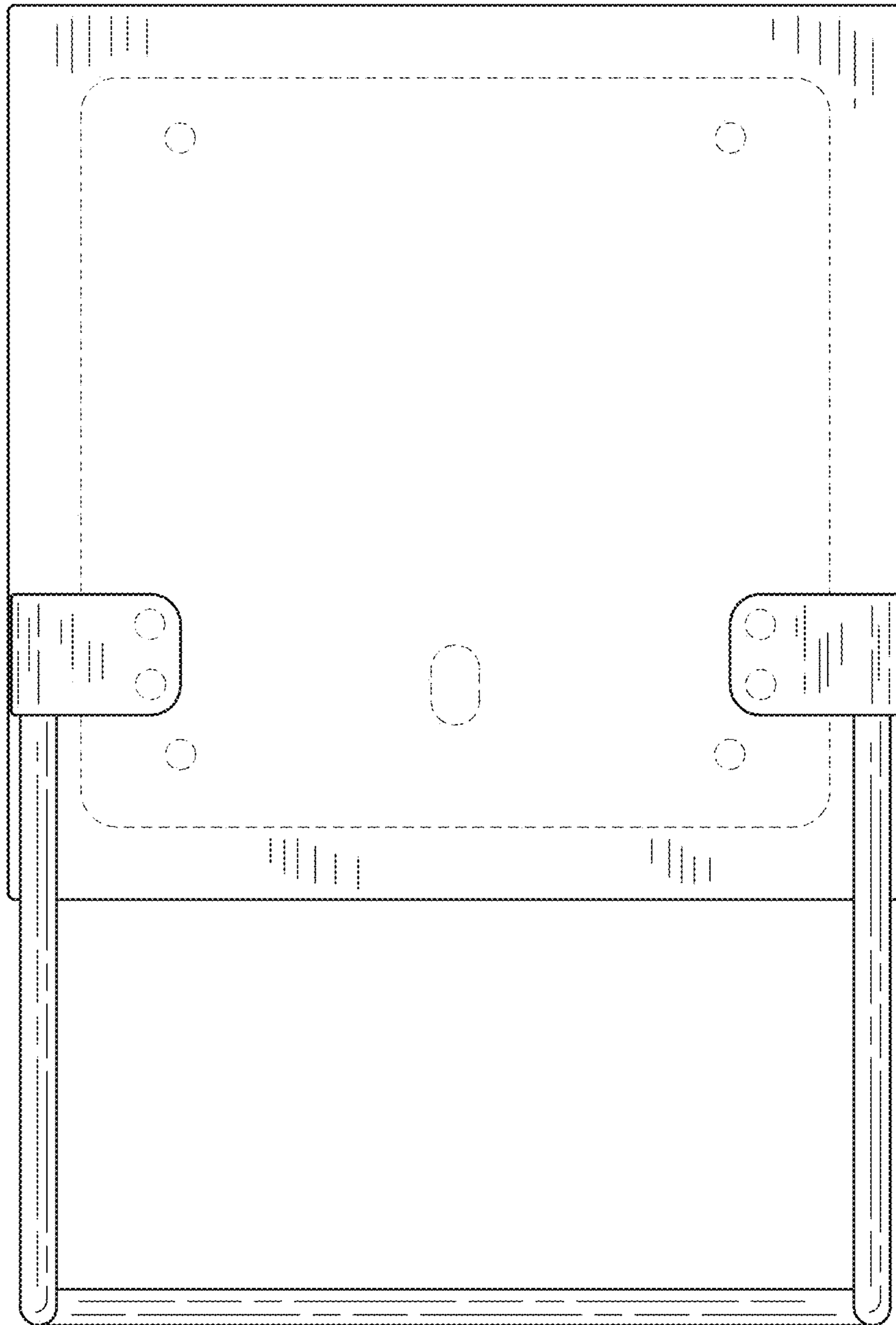

FIG.11

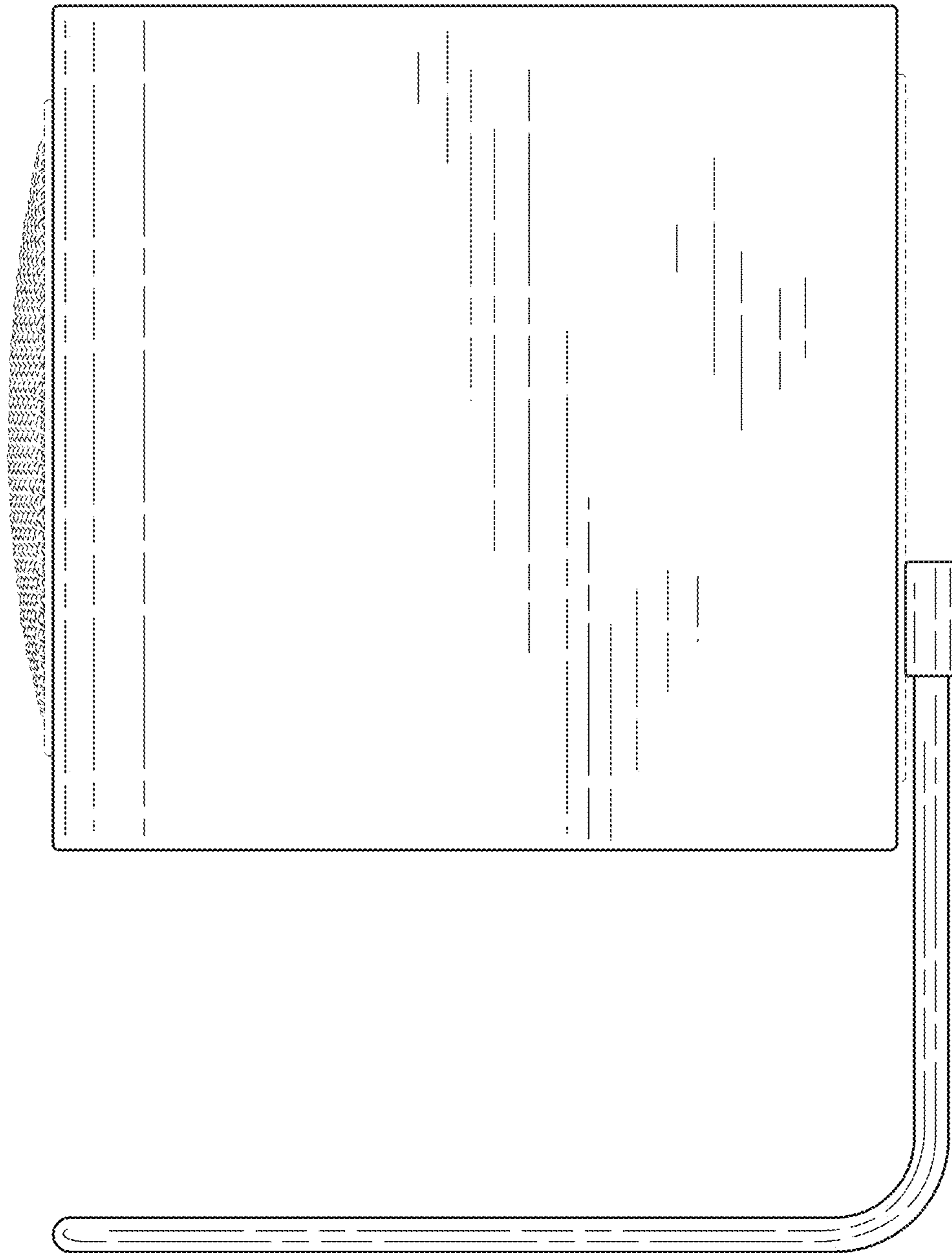

FIG. 12

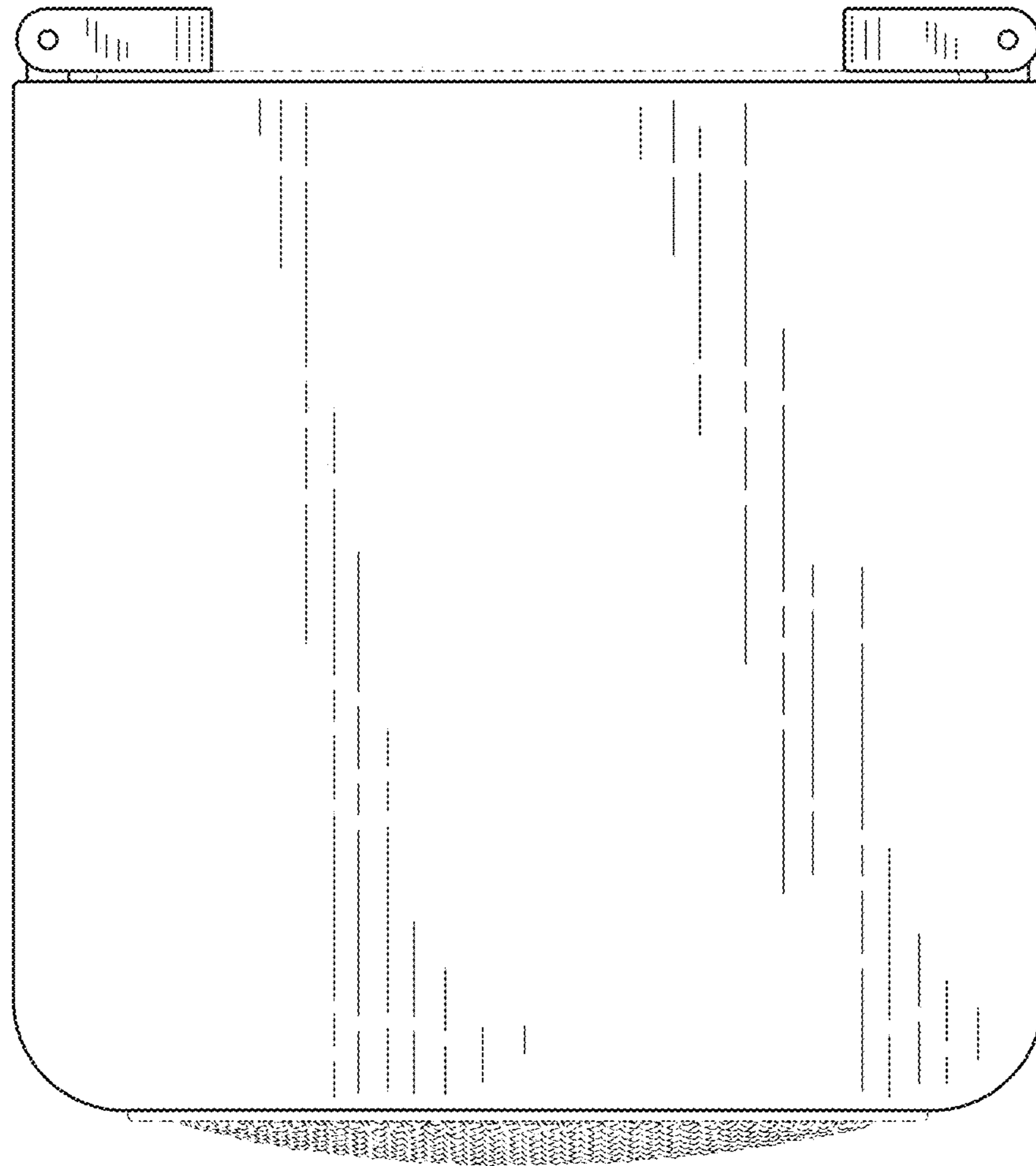

FIG.13

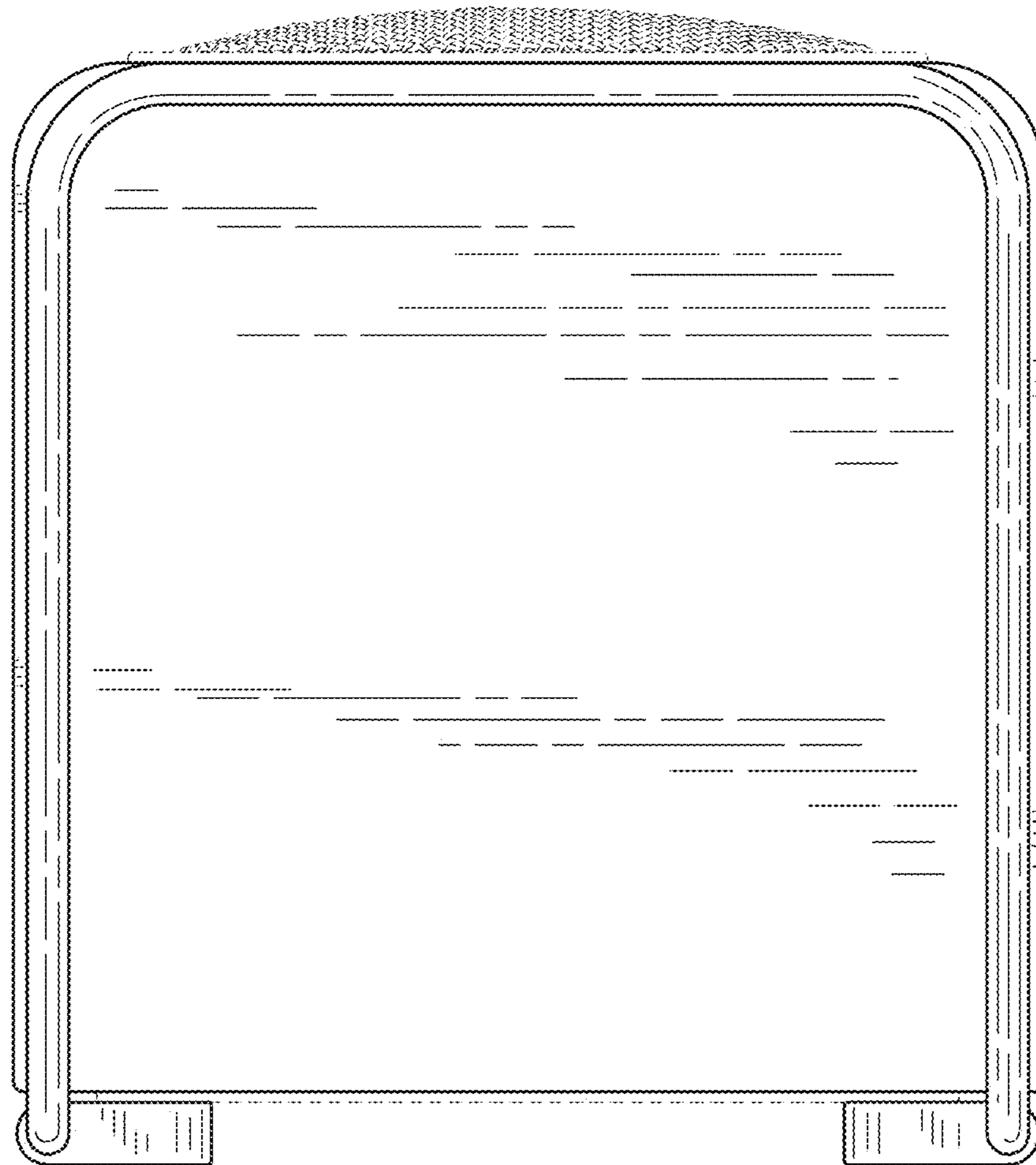

FIG.14